

# POLY CHAIN® GT® TAPER-LOCK® "PHOSPHATED" PULLEYS

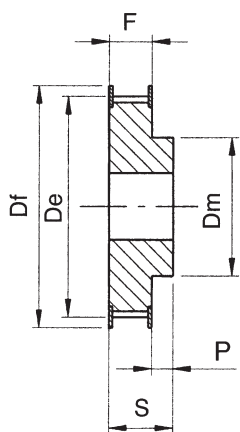

EXECUTION 1F

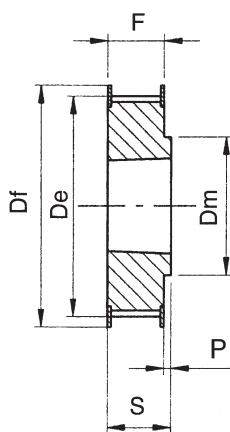

EXECUTION 2F

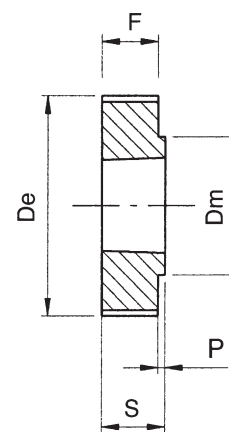

EXECUTION 3

## POLY CHAIN GT 8M-12

CHARACTERISTICS	TYPE	No. of TEETH	EXEC.	BUSH	MAX. BORE	Dp PITCH LINE	De EXTERNAL	Df FLANGE	Dm HUB	Di	F	S	P	FLANGE No.	WEIGHT KG.	
STEEL	WITH FLANGE	8M-22S-12	22	1F	-	28	56.02	54.42	60	43	-	20	30	-	53	0.43
	TL 8M-25S-12	25	2F	1108	28	63.66	62.06	70	49	-	20	22	-	61	0.25	
	TL 8M-28S-12	28	2F	1108	28	71.30	69.70	75	56	-	20	22	-	79	0.37	
	TL 8M-30S-12	30	2F	1210	32	76.39	74.79	82.5	60	-	20	25	-	82	0.41	
	TL 8M-32S-12	32	2F	1610	42	81.49	79.89	87	66	-	20	25	-	76	0.37	
	TL 8M-34S-12	34	2F	1610	42	86.58	84.98	91	69	-	20	25	-	66	0.45	
	TL 8M-36S-12	36	2F	1610	42	91.67	90.07	97	76	-	20	25	-	68	0.59	
	TL 8M-38S-12	38	2F	1610	42	96.77	95.17	102	78	-	20	25	-	70	0.70	
	TL 8M-40S-12	40	2F	1610	42	101.86	100.26	106	85	-	20	25	-	77	0.82	
	TL 8M-45S-12	45	2F	2012	50	114.59	112.99	120	92	-	20	32	-	75	1.10	
	TL 8M-48S-12	48	2F	2012	50	122.23	120.63	128	103	-	20	32	-	78	1.42	
	TL 8M-50S-12	50	2F	2012	50	127.32	125.72	135	104	-	20	32	-	80	1.60	
	TL 8M-56S-12	56	2F	2012	50	142.60	141.00	150	104	-	20	32	-	85	2.10	
	TL 8M-60S-12	60	2F	2012	50	152.79	151.19	158	111	-	20	32	-	86	2.40	
	TL 8M-64S-12	64	2F	2012	50	162.97	161.37	168	111	-	20	32	-	90	2.70	
	WITHOUT FLANGE	TL 8M-75S-12	75	3	2012	50	190.99	189.39	-	111	-	20	32	-	-	3.70
TL 8M-80S-12	80	3	2012	50	203.72	202.12	-	111	-	20	32	-	-	4.40		
TL 8M-90S-12	90	3	2012	50	229.18	227.58	-	111	-	20	32	-	-	5.50		

# POLY CHAIN® GT® TAPER-LOCK® "PHOSPHATED" PULLEYS

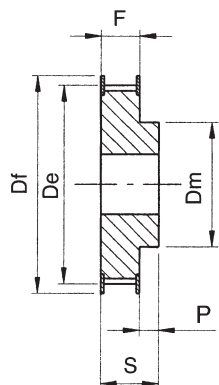

EXECUTION 1F

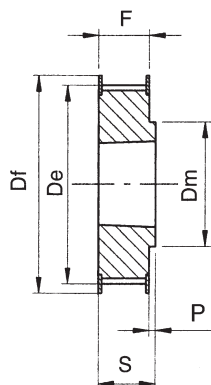

EXECUTION 2F

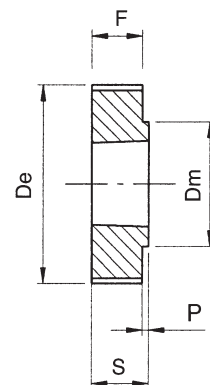

EXECUTION 3

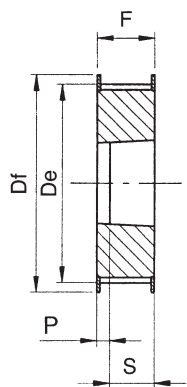

EXECUTION 4F

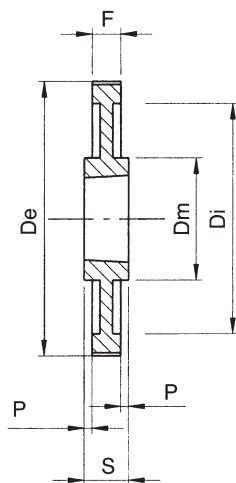

EXECUTION 11

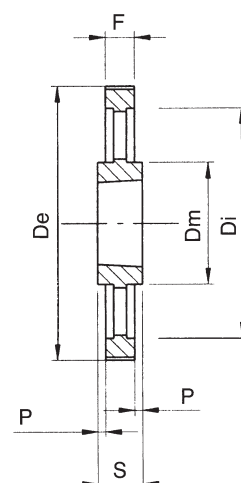

EXECUTION 13

## POLY CHAIN GT 8M-21

CHARACTERISTICS	TYPE	No. of TEETH	EXEC.	BUSH	MAX. BORE	Dp PITCH LINE	De EXTERNAL	Df FLANGE	Dm HUB	Di	F	S	P	FLANGE No.	WEIGHT KG.	
STEEL	WITH FLANGE	8M-22S-21	22	1F	-	28	56.02	54.42	60	43	-	30	42	-	53	0.56
	TL 8M-25S-21	25	4F	1108	28	63.66	62.06	70	-	-	30	22	-	-	61	0.36
	TL 8M-28S-21	28	4F	1210	32	71.30	69.70	75	-	-	30	25	-	-	79	0.41
	TL 8M-30S-21	30	4F	1210	32	76.39	74.79	82.5	-	-	30	25	-	-	82	0.56
	TL 8M-32S-21	32	4F	1610	42	81.49	79.89	87	-	-	30	25	-	-	76	0.52
	TL 8M-34S-21	34	4F	1610	42	86.58	84.98	91	-	-	30	25	-	-	66	0.61
	TL 8M-36S-21	36	4F	1610	42	91.67	90.07	97	-	-	30	25	-	-	68	0.70
	TL 8M-38S-21	38	4F	1610	42	96.77	95.17	102	-	-	30	25	-	-	70	0.92
	TL 8M-40S-21	40	4F	1610	42	101.86	100.26	106	-	-	30	25	-	-	77	1.06
	TL 8M-45S-21	45	2F	2012	50	114.59	112.99	120	92	-	30	32	-	-	75	1.30
	TL 8M-48S-21	48	2F	2012	50	122.23	120.63	128	103	-	30	32	-	-	78	1.60
	TL 8M-50S-21	50	2F	2012	50	127.32	125.72	135	104	-	30	32	-	-	80	1.83
	TL 8M-56S-21	56	2F	2012	50	142.60	141.00	150	104	-	30	32	-	-	85	2.40
	TL 8M-60S-21	60	2F	2517	60	152.79	151.19	158	124	-	30	45	-	-	86	3.20
	TL 8M-64S-21	64	2F	2517	60	162.97	161.37	168	124	-	30	45	-	-	90	3.80
	CAST IRON	WITHOUT FLANGE	TL 8M-75S-21	75	3	2517	60	190.99	189.39	-	124	-	30	45	-	-
TL 8M-80S-21		80	3	2517	60	203.72	202.12	-	124	-	30	45	-	-	6.00	
TL 8M-90S-21		90	11	2517	60	229.18	227.58	-	124	198	30	45	7.5	-	5.40	
TL 8M-112S-21		112	11	2517	60	285.21	283.61	-	124	253	30	45	7.5	-	7.40	
TL 8M-140S-21		140	13	3020	75	356.51	354.91	-	150	324	30	51	10.5	-	9.00	

# POLY CHAIN® GT® TAPER-LOCK® "PHOSPHATED" PULLEYS

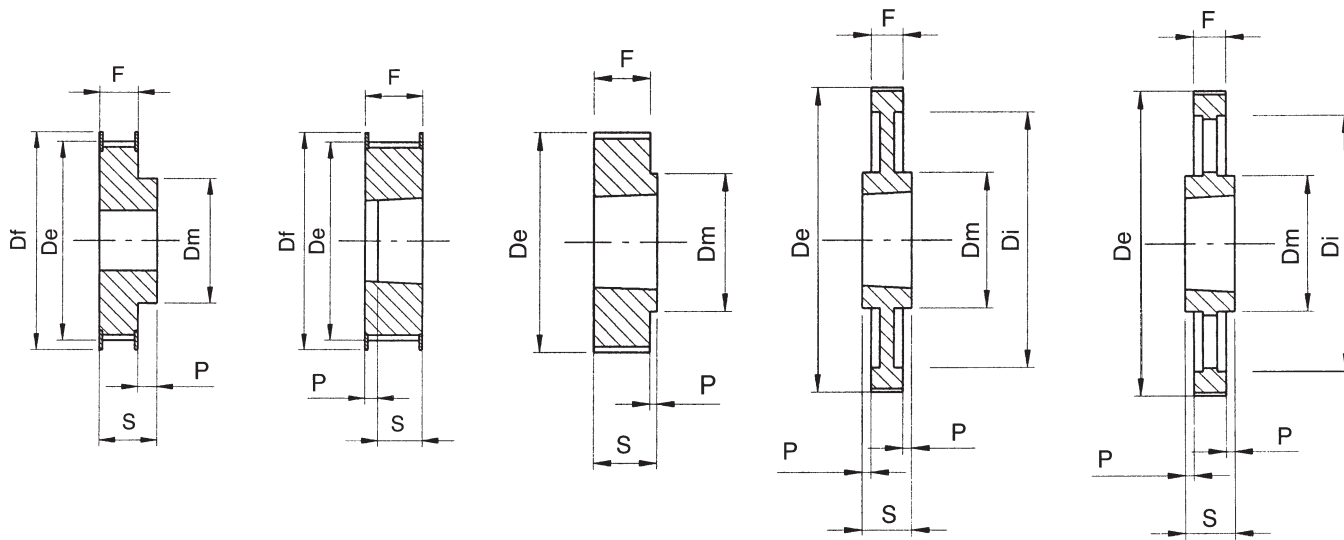

EXECUTION 1F

EXECUTION 4F

EXECUTION 3

EXECUTION 11

EXECUTION 13

## POLY CHAIN GT 8M-36

CHARACTERISTICS	TYPE	No. of TEETH	EXEC.	BUSH	MAX. BORE	Dp PITCH LINE	De EXTERNAL	Df FLANGE	Dm HUB	Di	F	S	P	FLANGE No.	WEIGHT KG.	
STEEL	WITH FLANGE	8M-25S-36	25	1F	-	32	63.66	62.06	70	49	-	45	55	-	61	1.04
		TL 8M-28S-36	28	4F	1210	32	71.30	69.70	75	-	-	45	25	20	79	0.64
		TL 8M-30S-36	30	4F	1610	42	76.39	74.79	82.5	-	-	45	25	20	82	0.59
		TL 8M-32S-36	32	4F	1610	42	81.49	79.89	87	-	-	45	25	20	76	0.79
		TL 8M-34S-36	34	4F	1610	42	86.58	84.98	91	-	-	45	25	20	66	0.93
		TL 8M-36S-36	36	4F	1610	42	91.67	90.07	97	-	-	45	25	20	68	1.15
		TL 8M-38S-36	38	4F	1610	42	96.77	95.17	102	-	-	45	25	20	70	1.39
		TL 8M-40S-36	40	4F	2012	50	101.86	100.26	106	-	-	45	32	13	77	1.34
		TL 8M-45S-36	45	4F	2012	50	114.59	112.99	120	-	-	45	32	13	75	1.87
		TL 8M-48S-36	48	4F	2012	50	122.23	120.63	128	-	-	45	32	13	78	2.20
		TL 8M-50S-36	50	4F	2012	50	127.32	125.72	135	-	-	45	32	13	80	2.70
		TL 8M-56S-36	56	4F	2517	60	142.60	141.00	150	-	-	45	45	-	85	3.00
		TL 8M-60S-36	60	4F	2517	60	152.79	151.19	158	-	-	45	45	-	86	3.80
		TL 8M-64S-36	64	4F	2517	60	162.97	161.37	168	-	-	45	45	-	90	4.50
CAST IRON	WITHOUT FLANGE	TL 8M-75S-36	75	3	3020	75	190.99	189.39	-	150	-	45	51	6	-	6.20
		TL 8M-80S-36	80	3	3020	75	203.72	202.12	-	150	-	45	51	6	-	7.40
		TL 8M-90S-36	90	11	3020	75	229.18	227.58	-	150	197	45	51	3	-	7.20
		TL 8M-112S-36	112	11	3020	75	285.21	283.61	-	150	253	45	51	3	-	10.40
		TL 8M-140S-36	140	13	3020	75	356.51	354.91	-	150	324	45	51	3	-	12.70
		TL 8M-168S-36	168	13	3525	100	427.81	426.21	-	198	396	45	65	10	-	21.50
		TL 8M-192S-36	192	13	3525	100	488.92	487.32	-	198	457	45	65	10	-	27.00

# POLY CHAIN® GT® TAPER-LOCK® "PHOSPHATED" PULLEYS

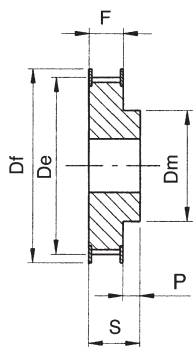

EXECUTION 1F

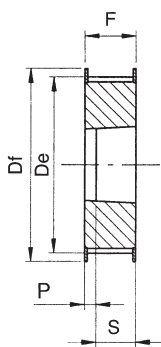

EXECUTION 4F

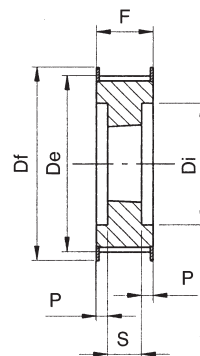

EXECUTION 7F

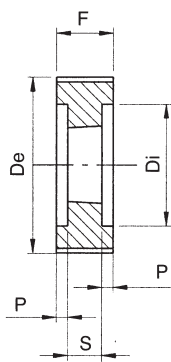

EXECUTION 6

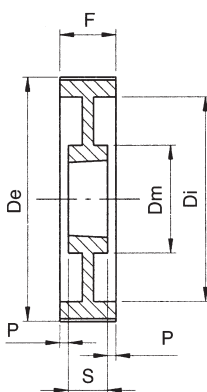

EXECUTION 8

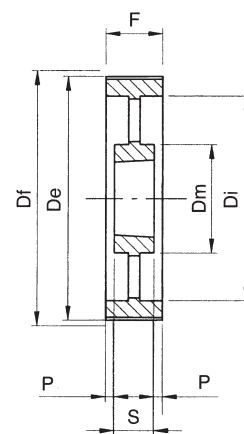

EXECUTION 10

## POLY CHAIN GT 8M-62

CHARACTERISTICS	TYPE	No. of TEETH	EXEC.	BUSH	MAX. BORE	Dp PITCH LINE	De EXTERNAL	Df FLANGE	Dm HUB	Di	F	S	P	FLANGE No.	WEIGHT KG.	
STEEL	WITH FLANGE	8M-30S-62	30	1F	-	42	76.39	74.79	82.5	63	-	72	84	-	82	2.40
		8M-32S-62	32	1F	-	50	81.49	79.89	87	68	-	72	84	-	76	2.80
		8M-34S-62	34	1F	-	55	86.58	84.98	91	69	-	72	84	-	66	3.00
		8M-36S-62	36	1F	-	60	91.67	90.07	97	76	-	72	84	-	68	3.40
		8M-38S-62	38	1F	-	60	96.77	95.17	102	78	-	72	84	-	70	3.80
		TL 8M-40S-62	40	4F	2012	50	101.86	100.26	106	-	-	72	32	-	77	2.06
		TL 8M-45S-62	45	4F	2012	50	114.59	112.99	120	-	-	72	32	-	75	3.00
		TL 8M-48S-62	48	4F	2517	60	122.23	120.63	128	-	-	72	45	-	78	2.90
		TL 8M-50S-62	50	4F	2517	60	127.32	125.72	135	-	-	72	45	-	80	3.25
		TL 8M-56S-62	56	7F	2517	60	142.60	141.00	150	-	111	72	45	13.5	85	3.90
		TL 8M-60S-62	60	7F	2517	60	152.79	151.19	158	-	121	72	45	13.5	86	4.70
		TL 8M-64S-62	64	7F	2517	60	162.97	161.37	168	-	131	72	45	13.5	90	5.60
		TL 8M-75S-62	75	6	3020	75	190.99	189.39	-	-	159	72	51	10.5	-	7.50
		TL 8M-80S-62	80	6	3020	75	203.72	202.12	-	-	172	72	51	10.5	-	9.20
TL 8M-90S-62	90	6	3020	75	229.18	227.58	-	-	197	72	51	10.5	-	7.70		
CAST IRON	WITHOUT FLANGE	TL 8M-112S-62	112	8	3020	75	285.21	283.61	-	198	253	72	51	10.5	-	12.10
		TL 8M-140S-62	140	8	3525	100	356.51	354.91	-	150	324	72	65	3.5	-	22.70
		TL 8M-168S-62	168	10	3525	100	427.81	426.21	-	198	396	72	65	3.5	-	26.80
		TL 8M-192S-62	192	10	3525	100	488.92	487.32	-	198	457	72	65	3.5	-	34.20

# POLY CHAIN® GT® TAPER-LOCK® "PHOSPHATED" PULLEYS

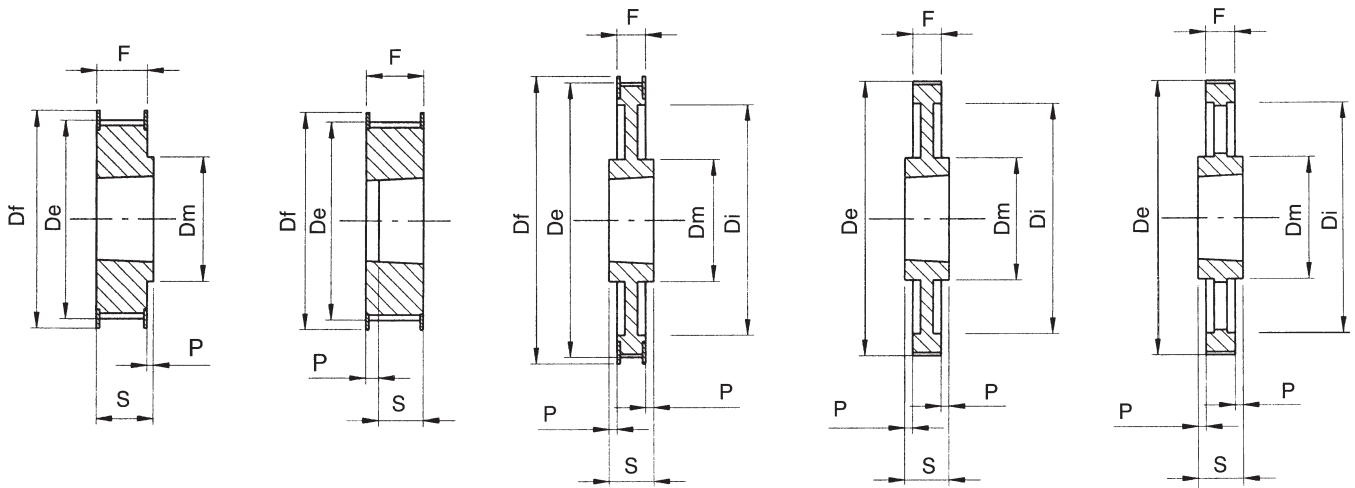

EXECUTION 2F

EXECUTION 4F

EXECUTION 12F

EXECUTION 11

EXECUTION 13

## POLY CHAIN GT 14M-20

CHARACTERISTICS	TYPE	No. of TEETH	EXEC.	BUSH	MAX. BORE	Dp PITCH LINE	De EXTERNAL	Df FLANGE	Dm HUB	Di	F	S	P	FLANGE No.	WEIGHT KG.	
STEEL	WITH FLANGE	TL 14M-28S-20	28	4F	2012	50	124.78	121.98	128	-	-	33	32	1	153	1.66
		TL 14M-30S-20	30	4F	2012	50	133.69	130.89	138	-	-	33	32	1	154	2.20
		TL 14M-32S-20	32	4F	2012	50	142.60	139.80	154	-	-	33	32	1	160	3.20
		TL 14M-34S-20	34	2F	2517	60	151.52	148.72	160	117	-	33	45	-	171	3.00
		TL 14M-36S-20	36	2F	2517	60	160.43	157.63	168	117	-	33	45	-	168	3.60
		TL 14M-38S-20	38	2F	2517	60	169.34	166.54	183	117	-	33	45	-	172	4.00
		TL 14M-40S-20	40	2F	2517	60	178.25	175.45	188	117	-	33	45	-	174	4.70
		TL 14M-44S-20	44	2F	3020	75	196.08	193.28	211	144	-	33	51	-	175	5.60
		TL 14M-48S-20	48	2F	3020	75	213.90	211.11	226	144	-	33	51	-	180	6.80
		TL 14M-50S-20	50	2F	3020	75	222.82	220.02	240	144	-	33	51	-	169	7.70
TL 14M-56S-20	56	12F	3020	75	249.55	246.76	256	144	207	33	51	9	182	7.70		
	TL 14M-60S-20	60	11	3020	75	267.38	264.58	-	159	224	33	51	9	-	8.50	
CAST IRON	WITHOUT FLANGE	TL 14M-64S-20	64	11	3020	75	285.21	282.41	-	159	242	33	51	9	-	10.20
		TL 14M-72S-20	72	11	3020	75	320.86	318.06	-	159	278	33	51	9	-	11.50
		TL 14M-80S-20	80	11	3020	75	356.51	353.71	-	159	314	33	51	9	-	13.50
		TL 14M-90S-20	90	13	3020	75	401.07	398.27	-	159	360	33	51	9	-	14.20
		TL 14M-112S-20	112	13	3020	75	499.11	496.31	-	159	456	33	51	9	-	18.10
		TL 14M-140S-20	140	13	3020	75	623.89	621.09	-	159	581	33	51	9	-	22.90

# POLY CHAIN® GT® TAPER-LOCK® "PHOSPHATED" PULLEYS

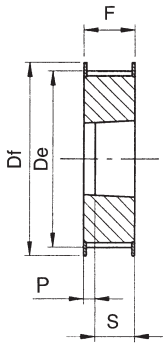

EXECUTION 4F

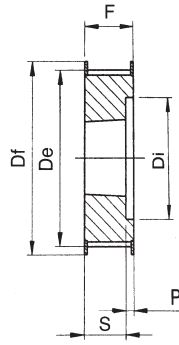

EXECUTION 5F

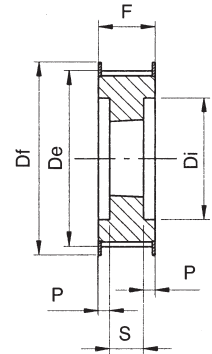

EXECUTION 7F

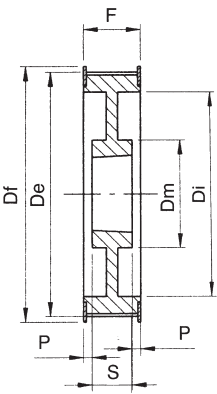

EXECUTION 9F

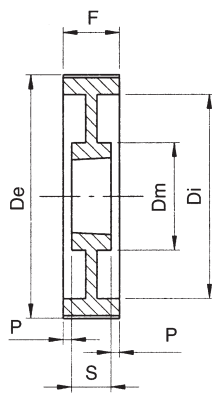

EXECUTION 8

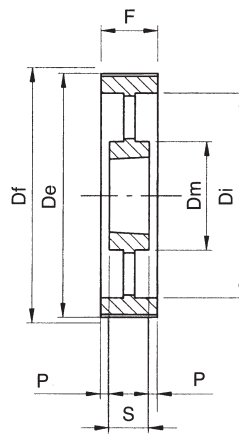

EXECUTION 10

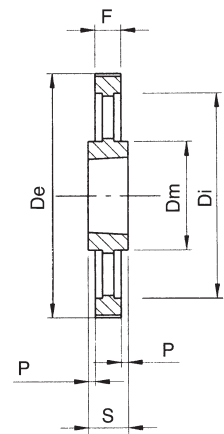

EXECUTION 13

## POLY CHAIN GT 14M-37

CHARACTERISTICS	TYPE	No. of TEETH	EXEC.	BUSH	MAX. BORE	Dp		Df FLANGE	Dm HUB	Di	F	S	P	FLANGE No.	WEIGHT KG.		
						PITCH LINE	EXTERNAL										
STEEL	WITH FLANGE	TL 14M-28S-37	28	5F	2012	50	124.78	121.98	128	-	88	51	32	19	153	2.20	
		TL 14M-30S-37	30	7F	2517	60	133.69	130.89	138	-	98	51	45	3	154	2.50	
		TL 14M-32S-37	32	7F	2517	60	142.60	139.80	154	-	100	51	45	3	160	3.00	
		TL 14M-34S-37	34	7F	2517	60	151.52	148.72	160	-	109	51	45	3	171	3.80	
		TL 14M-36S-37	36	5F	2517	60	160.43	157.63	168	-	117	51	45	6	168	4.30	
		TL 14M-38S-37	38	5F	2517	60	169.34	166.54	183	-	126	51	45	6	172	5.10	
		TL 14M-40S-37	40	5F	2517	60	178.25	175.45	188	-	135	51	45	6	174	6.00	
		TL 14M-44S-37	44	4F	3020	75	196.08	193.28	211	-	-	51	51	-	-	175	7.00
		TL 14M-48S-37	48	4F	3020	75	213.90	211.11	226	-	-	51	51	-	-	180	9.00
		TL 14M-50S-37	50	4F	3020	75	222.82	220.02	240	-	-	51	51	-	-	169	10.00
TL 14M-56S-37	56	9F	3020	75	249.55	246.76	256	144	207	51	51	-	-	182	9.20		
CAST IRON	WITHOUT FLANGE	TL 14M-60S-37	60	8	3020	75	267.38	264.58	-	159	224	51	51	-	-	10.20	
		TL 14M-64S-37	64	8	3020	75	285.21	282.41	-	159	242	51	51	-	-	12.20	
		TL 14M-72S-37	72	8	3020	75	320.86	318.06	-	159	278	51	51	-	-	13.40	
		TL 14M-80S-37	80	8	3020	75	356.51	353.71	-	159	314	51	51	-	-	16.10	
		TL 14M-90S-37	90	10	3020	75	401.07	398.27	-	159	360	51	51	-	-	17.20	
		TL 14M-112S-37	112	10	3020	75	499.11	496.31	-	159	456	51	51	-	-	23.00	
		TL 14M-140S-37	140	13	3525	100	623.89	621.09	-	206	581	51	65	7	-	41.00	
		TL 14M-168S-37	168	13	3525	100	748.66	745.87	-	206	706	51	65	7	-	51.50	
		TL 14M-192S-37	192	13	4030	115	855.61	852.82	-	215	812	51	76	12.5	-	60.00	

# POLY CHAIN® GT® TAPER-LOCK® "PHOSPHATED" PULLEYS

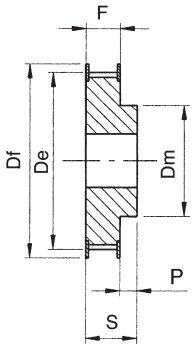

EXECUTION 1F

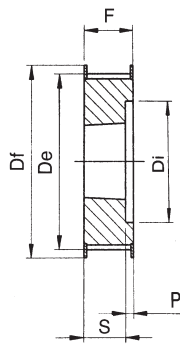

EXECUTION 5F

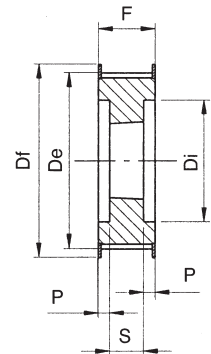

EXECUTION 7F

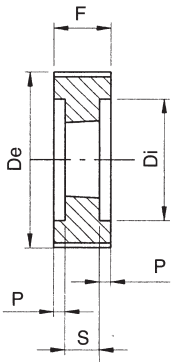

EXECUTION 6

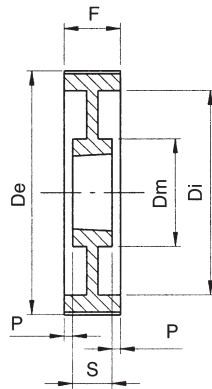

EXECUTION 8

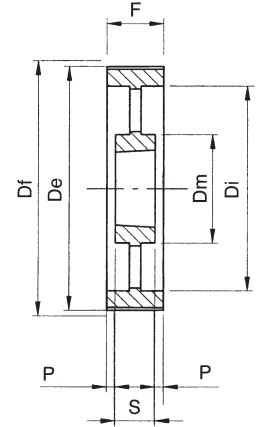

EXECUTION 10

## POLY CHAIN GT 14M-68

CHARACTERISTICS	TYPE	No. of TEETH	EXEC.	BUSH	MAX. BORE	Dp PITCH LINE	De EXTERNAL	Df FLANGE	Dm HUB	Di	F	S	P	FLANGE No.	WEIGHT KG.	
STEEL	WITH FLANGE	14M-34S-68	34	1F	-	100	151.52	148.72	160	132	-	84	104	-	171	10.50
		14M-36S-68	36	1F	-	100	160.43	157.63	168	131	-	84	104	-	168	11.70
		14M-38S-68	38	1F	-	115	169.34	166.54	183	141	-	84	104	-	172	13.40
		14M-40S-68	40	1F	-	125	178.25	175.45	188	156	-	84	104	-	174	15.40
		TL 14M-44S-68	44	7F	3020	75	196.08	193.28	211	-	153	84	51	16.5	175	9.20
		TL 14M-48S-68	48	5F	3020	75	213.90	211.11	226	-	171	84	51	33	180	11.30
		TL 14M-50S-68	50	7F	3525	100	222.82	220.02	240	-	180	84	65	9.5	169	15.50
		TL 14M-56S-68	56	7F	3525	100	249.55	246.76	256	-	207	84	65	9.5	182	16.80
	TL 14M-60S-68	60	6	3525	100	267.38	264.58	-	-	224	84	65	9.5	-	20.40	
CAST IRON	WITHOUT FLANGE	TL 14M-64S-68	64	6	3525	100	285.21	282.41	-	-	242	84	65	9.5	-	23.60
		TL 14M-72S-68	72	8	3525	100	320.86	318.06	-	178	278	84	65	9.5	-	20.30
		TL 14M-80S-68	80	8	3525	100	356.51	353.71	-	178	314	84	65	9.5	-	21.30
		TL 14M-90S-68	90	10	3525	100	401.07	398.27	-	178	360	84	65	9.5	-	24.40
		TL 14M-112S-68	112	10	3525	100	499.11	496.31	-	178	456	84	65	9.5	-	32.70
		TL 14M-140S-68	140	10	3525	100	623.89	621.09	-	206	581	84	65	9.5	-	55.00
		TL 14M-168S-68	168	10	3525	100	748.66	745.87	-	206	706	84	65	9.5	-	71.00
		TL 14M-192S-68	192	10	4030	115	855.61	852.82	-	215	812	84	76	4	-	80.50

# POLY CHAIN® GT® TAPER-LOCK® "PHOSPHATED" PULLEYS

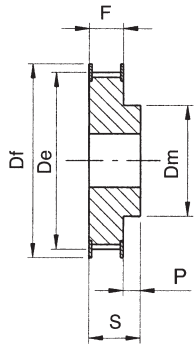

EXECUTION 1F

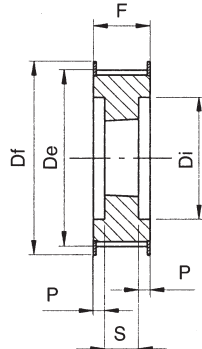

EXECUTION 7F

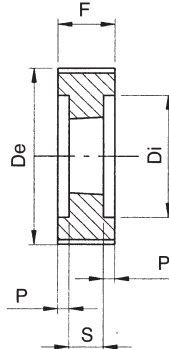

EXECUTION 6

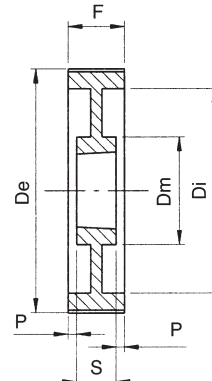

EXECUTION 8

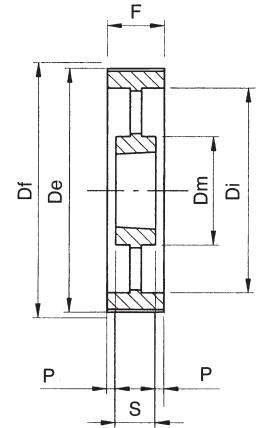

EXECUTION 10

## POLY CHAIN GT 14M-90

CHARACTERISTICS		TYPE	No. of TEETH	EXEC.	BUSH	MAX. BORE	Dp PITCH LINE	De EXTERNAL	Df FLANGE	Dm HUB	Di	F	S	P	FLANGE No.	WEIGHT KG.
STEEL	WITH FLANGE	14M-36S-90	36	1F	-	110	160.43	157.63	168	131	-	106	136	-	168	14.50
		14M-38S-90	38	1F	-	115	169.34	166.54	183	141	-	106	136	-	172	17.50
		14M-40S-90	40	1F	-	125	178.25	175.45	188	156	-	106	136	-	174	19.10
		14M-44S-90	44	1F	-	140	196.08	193.28	211	169	-	106	136	-	175	23.90
		TL 14M-48S-90	48	7F	3525	100	213.90	211.11	226	-	171	106	66	20	180	12.70
		TL 14M-50S-90	50	7F	3525	100	222.82	220.02	240	-	180	106	66	20	169	14.50
		TL 14M-56S-90	56	7F	3525	100	249.55	246.76	256	-	207	106	66	20	182	19.00
		TL 14M-60S-90	60	6	3525	100	267.38	264.58	-	-	224	106	66	20	-	22.50
CAST IRON	WITHOUT FLANGE	TL 14M-64S-90	64	6	3525	100	285.21	282.41	-	-	242	106	66	20	-	24.00
		TL 14M-72S-90	72	8	3525	100	320.86	318.06	-	178	278	106	66	20	-	22.60
		TL 14M-80S-90	80	8	4030	115	356.51	353.71	-	215	314	106	76	15	-	27.00
		TL 14M-90S-90	90	8	4030	115	401.07	398.27	-	215	360	106	76	15	-	34.10
		TL 14M-112S-90	112	10	4535	125	499.11	496.31	-	215	456	106	90	8	-	46.00
		TL 14M-140S-90	140	10	4535	125	623.89	621.09	-	215	581	106	90	8	-	61.00
		TL 14M-168S-90	168	10	5040	130	748.66	745.87	-	267	706	106	102	2	-	90.00
		TL 14M-192S-90	192	10	5040	130	855.61	852.82	-	267	812	106	102	2	-	108.50



# POLY CHAIN® GT® TAPER-LOCK® "PHOSPHATED" PULLEYS

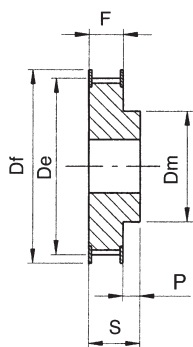

EXECUTION 1F

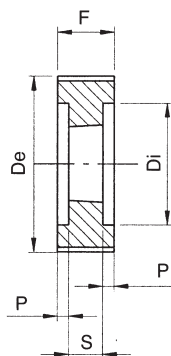

EXECUTION 6

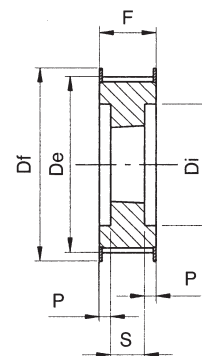

EXECUTION 7F

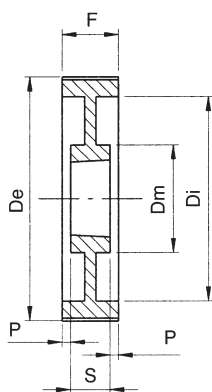

EXECUTION 8

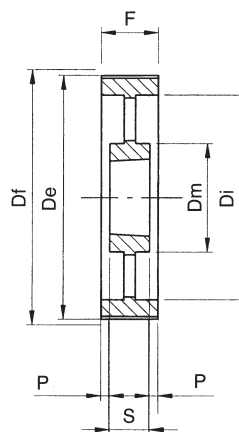

EXECUTION 10

## POLY CHAIN GT 14M-125

CHARACTERISTICS	TYPE	No. of TEETH	EXEC.	BUSH	MAX. BORE	Dp PITCH LINE	De EXTERNAL	Df FLANGE	Dm HUB	Di	F	S	P	FLANGE No.	WEIGHT KG.	
STEEL	WITH FLANGE	14M-38S-125	38	1F	-	115	169.34	166.54	183	141	-	141	161	-	172	20.30
		14M-40S-125	40	1F	-	125	178.25	175.45	188	156	-	141	161	-	174	23.00
		14M-44S-125	44	1F	-	140	196.08	193.28	211	169	-	141	161	-	175	28.80
		14M-48S-125	48	1F	-	160	213.90	211.11	226	185	-	141	161	-	180	34.60
		TL 14M-50S-125	50	7F	3525	100	222.82	220.02	240	-	180	141	65	38	169	16.80
		TL 14M-56S-125	56	7F	3525	100	249.55	246.76	256	-	207	141	65	38	182	21.60
CAST IRON	WITHOUT FLANGE	TL 14M-60S-125	60	6	4030	115	267.38	264.58	-	-	224	141	76	32.5	-	25.60
		TL 14M-64S-125	64	6	4030	115	285.21	282.41	-	-	242	141	76	32.5	-	29.70
		TL 14M-72S-125	72	8	4030	115	320.86	318.06	-	215	278	141	76	32.5	-	30.00
		TL 14M-80S-125	80	8	4030	125	356.51	353.71	-	215	314	141	76	32.5	-	33.40
		TL 14M-90S-125	90	8	4030	115	401.07	398.27	-	215	360	141	76	32.5	-	39.40
		TL 14M-112S-125	112	10	4535	125	499.11	496.31	-	215	456	141	89	26	-	56.00
		TL 14M-140S-125	140	10	4535	125	623.89	621.09	-	215	581	141	89	26	-	73.00
		TL 14M-168S-125	168	10	5040	125	748.66	745.87	-	267	706	141	102	19.5	-	101.00
		TL 14M-192S-125	192	10	5040	125	855.61	852.82	-	267	802	141	102	19.5	-	121.50

"GATES" licence N. 0.203.235