



versamove
Pallet Handling Systems



Modular. Compatible. Versatile.



versa*move*

Pallet Handling Systems



Modular. Compatible. Versatile.

mk – we're one of the leading suppliers of mechanical components, modules and turnkey solutions for factory automation. With Versamove we offer flexible pallet handling systems based on the customer's requirements. Equipped with modules and components from the mk modular system for profiles, conveyors and linear technology, Versamove systems offer dependability, high quality and process reliability.

Modular.



The modular design of Versamove ensures fast, transparent planning and project development. Versamove can be flexibly expanded and excellently adapted to your specific requirements.

Compatible.

When developing the system, particular attention was paid to compatibility to systems already available on the market. And that means, for example, pallets of other manufacturers can also be used on the Versamove standard. This enables existing systems to be easily expanded with Versamove.

Versatile.

„Versa“ stands for Versatility. VersaMove can be used in virtually all areas of automation and material flow. Whether it's individual modules or turnkey solutions – with Versamove we offer complete all-around service, including control, commissioning and maintenance.

 <p>versa<i>move</i> standard</p>	 <p>versa<i>move</i> plus</p>	 <p>versa<i>move</i> ultra</p>
Total load of pallet		
up to 40 kg	up to 100 kg	up to 300 kg
Pallet sizes		
Width: 240, 320, 400 mm Length: 240, 320, 400 mm	Width: 400 up to 800 mm Length: 400 up to 1040 mm	Width: 600 up to 1200 mm Length: 600 up to 1200 mm
Frame cross-section		
100 x 45 mm	100 x 50 mm	135 x 60 mm
Conveyor types		
Flat top chain conveyors Timing belt conveyors Accumulating roller conveyors	Timing belt conveyors Chain conveyors Accumulating roller conveyors	Accumulating roller conveyors
Special features		
Curved module	Versatile pallet sizes	High load capacity

Always the right system

Divided according to three weight and size classes, the right system is always available for any application. The versatile pallet sizes and the choice of different conveyor types make Versamove

extremely flexible. Fast cycle times with high precision is ensured with timing belt conveyors. Accumulating roller conveyors are especially well-suited for accumulating operation and for heavily loaded

applications. The flat top chain conveyor also offers accumulation capability and in addition enables direction changes using curved frames.

Features

- ✓ Up to 40 kg total weight per pallet
- ✓ Pallet sizes: 240 x 240 to 400 x 400 mm
- ✓ Compatible with existing systems on the market

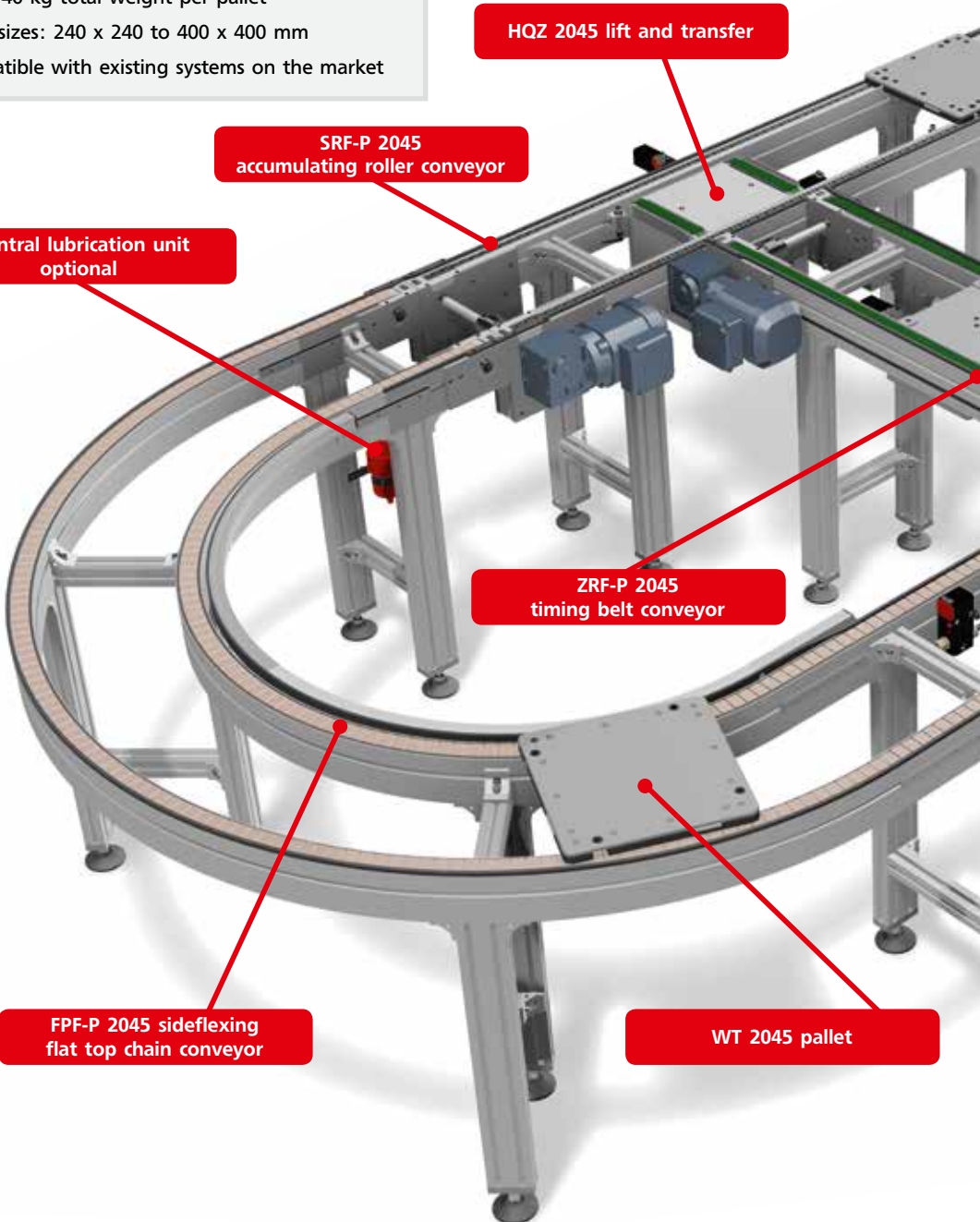

HQZ 2045 lift and transfer

SRF-P 2045 accumulating roller conveyor

Central lubrication unit optional

ZRF-P 2045 timing belt conveyor

FPF-P 2045 sideflexing flat top chain conveyor

WT 2045 pallet

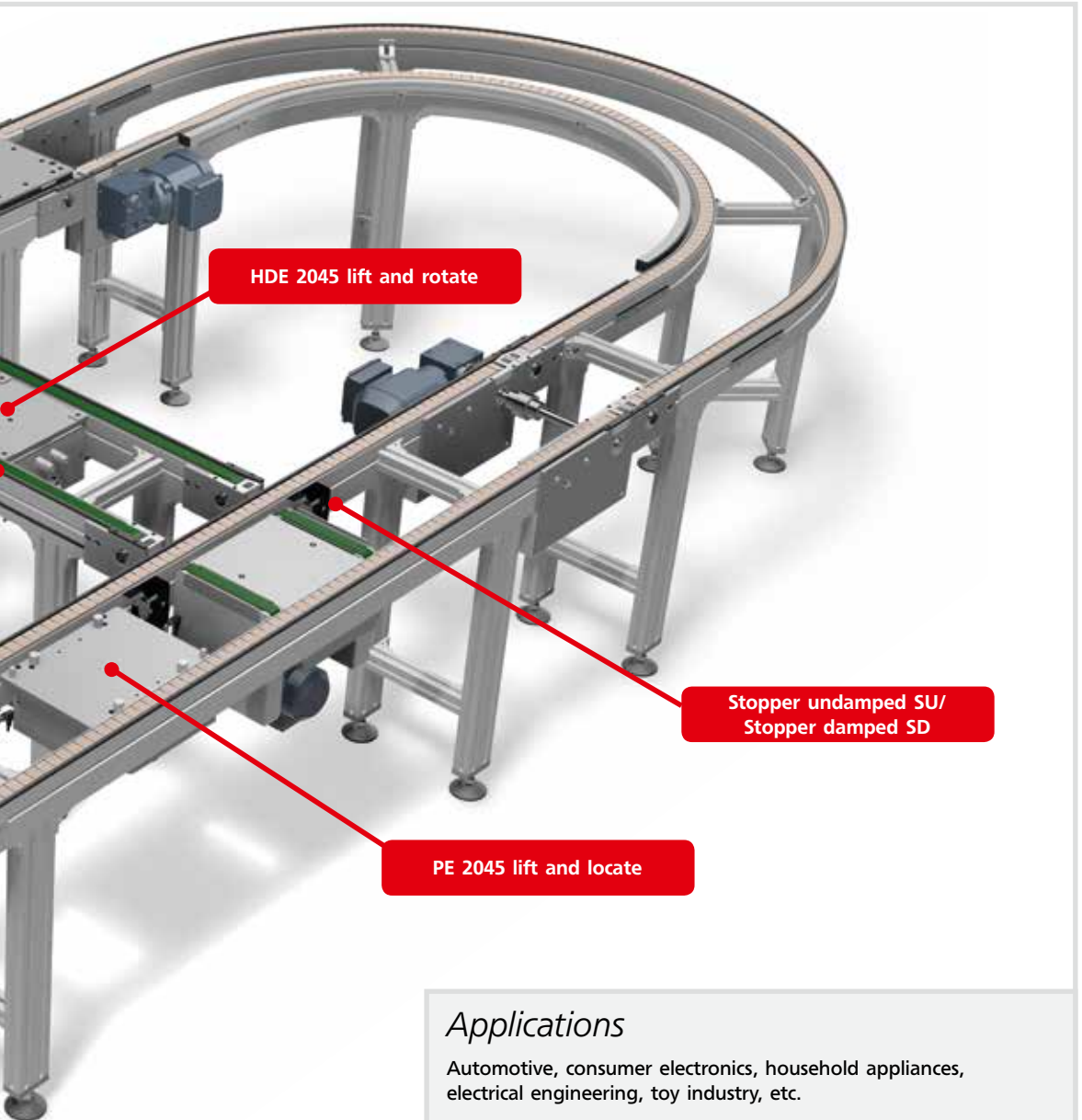

HDE 2045 lift and rotate

Stopper undamped SU/
Stopper damped SD



PE 2045 lift and locate



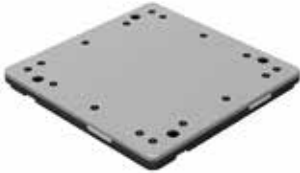
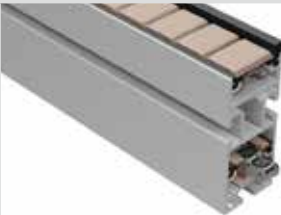
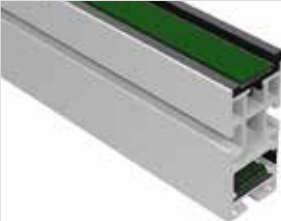

Applications

Automotive, consumer electronics, household appliances, electrical engineering, toy industry, etc.



Versamove standard modules

	Features	Tech. data
WT 2045 pallet 	<ul style="list-style-type: none"> ■ Aluminum surface plate (steel optional) ■ Locating bushings in surface plate for positioning and turning pallets ■ PE slide rails (steel optional) ■ Integrated damping bumpers ■ Available in anti-static design as an option 	<ul style="list-style-type: none"> ■ Up to zu 40 kg total load ■ Width: 240, 320, 400 mm ■ Length: 240, 320, 400 mm
PPF-P 2045 flat top chain conveyor 	<ul style="list-style-type: none"> ■ Suitable for accumulating operation ■ Curve module (minimum radius of 600 mm) ■ Curve angle 90° and 180° ■ Automatic chain tensioning included ■ Available in anti-static design as an option 	<ul style="list-style-type: none"> ■ Length: 500-6000 mm ■ Section load: 70 kg/m ■ Total load: 400 kg ■ Speeds: 6; 9; 12; 15 and 18 m/min
ZRF-P 2045 timing belt conveyor 	<ul style="list-style-type: none"> ■ Conditionally suitable for accumulating operation ■ Especially well-suited for indexing operation ■ High acceleration ■ Reversing operation possible ■ Low-maintenance ■ Available in anti-static design as an option 	<ul style="list-style-type: none"> ■ Length: 500-6000 mm ■ Section load: 60 kg/m ■ Total load: 200 kg ■ Speeds: 6; 9; 12; 15 and 18 m/min ■ PAR/PAZ coating
SRF-P 2045 accumulating roller conveyor 	<ul style="list-style-type: none"> ■ Especially well-suited for accumulating operation ■ High operating temperatures ■ Accumulating rollers available in steel and plastic ■ Automatic chain tensioning included ■ Available in anti-static design as an option 	<ul style="list-style-type: none"> ■ Length: 500-6000 mm ■ Section load: 80 kg/m ■ Total load: 700 kg ■ Speeds: 6; 9; 12; 15 and 18 m/min
HQZ 2045 lift and transfer 	<ul style="list-style-type: none"> ■ Low overall height ■ Pneumatic lifting movement ■ Guidance using linear bearings and guide rods ■ Manual belt tensioning included ■ Inductive position detection (reed switches optional) 	<ul style="list-style-type: none"> ■ Loads up to 40 kg ■ Speeds: 6; 9; 12; 15 and 18 m/min ■ Stroke: 20 mm

	Features	Tech. data
HDE 2045 lift and rotate		
	<ul style="list-style-type: none"> ■ Low overall height ■ Individual rotation speeds ■ Pneumatic lifting and rotating movement ■ Guidance using linear bearings and guide rods ■ Inductive position detection (reed switches optional) 	<ul style="list-style-type: none"> ■ Loads up to 40 kg ■ Rotating movement 90° and 180°
Stopper undamped SU/damped SD		
	<ul style="list-style-type: none"> ■ Undamped and damped stopping ■ Stopper querying possible electrically or inductively ■ Single or dual-acting ■ Direct installation on conveyor frame (no additional bracket required) 	<p>Permissible load is dependent on stopper version and conveying speed</p>
PE 2045 lift and locate		
	<ul style="list-style-type: none"> ■ Positioning in X, Y and Z-direction ■ Positioning via locating bushings in surface plate of pallets ■ Inductive position detection 	<ul style="list-style-type: none"> ■ Repeat accuracy: ± 0,1 mm ■ Cylinder stroke: 30 mm
KHL 2045 short stroke lift		
	<ul style="list-style-type: none"> ■ Moving between two transport elevations ■ Pneumatic lifting and lowering ■ Speeds are steplessly adjustable ■ Conveying type FPF, ZRF and SRF possible (ZRF shown here) 	<ul style="list-style-type: none"> ■ Effective load up to 100 kg
Maintenance access WTZ 2045		
	<ul style="list-style-type: none"> ■ Simple access to interior through lift-gate conveyor ■ Fast, safe maintenance ■ Gas spring secures against falling back ■ Safety switch protects against unauthorized access 	

Features

- ✓ Up to 100 kg total weight per pallet
- ✓ Pallet sizes: 400 x 400 to 800 x 1040 mm
- ✓ Versatile and individually adjustable

Stopper undamped SU/
Stopper damped SD

WT 2010 pallet

HQZ 2010 lift and transfer

Maintenance access WTZ 2010
(lift-gate conveyor)

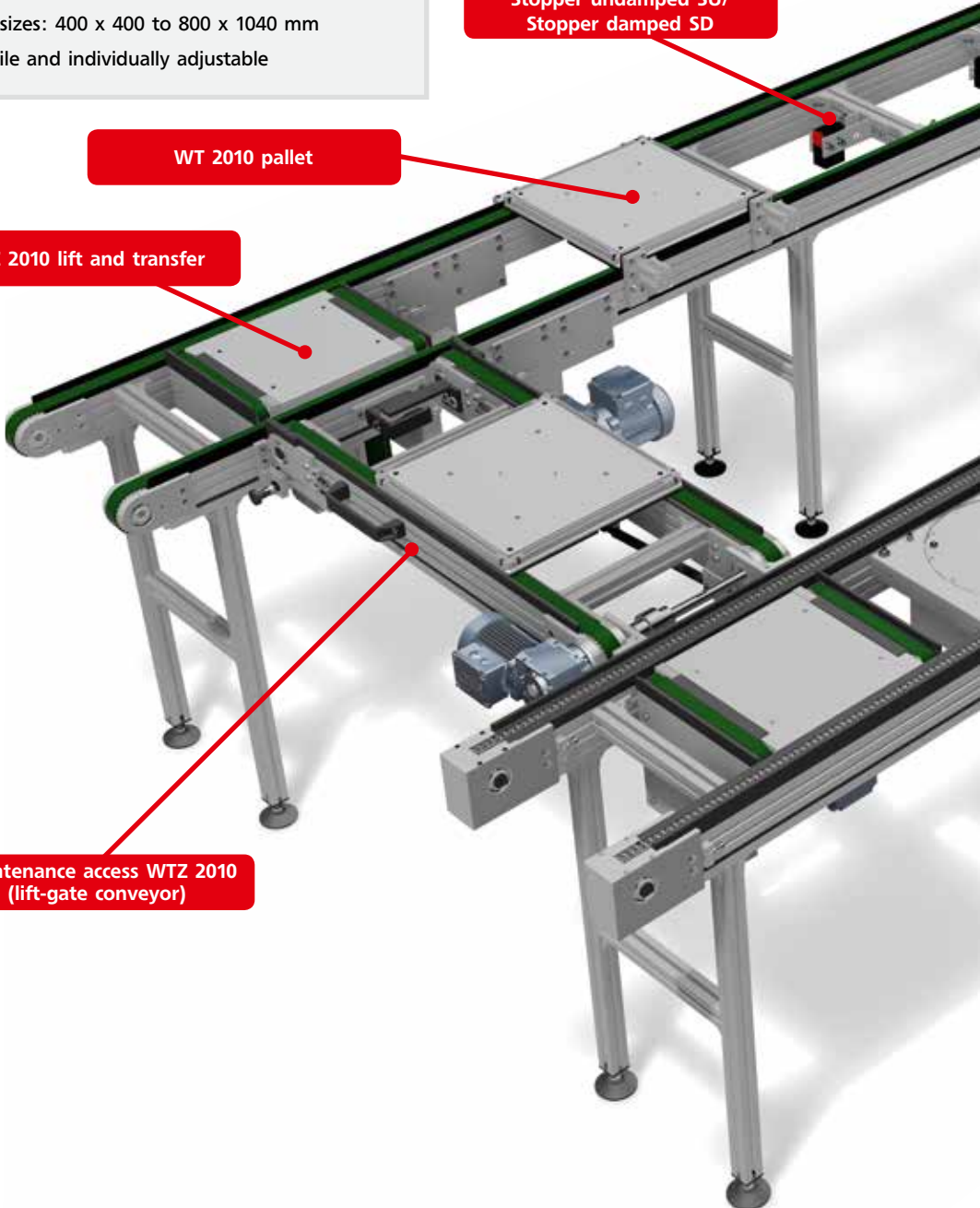

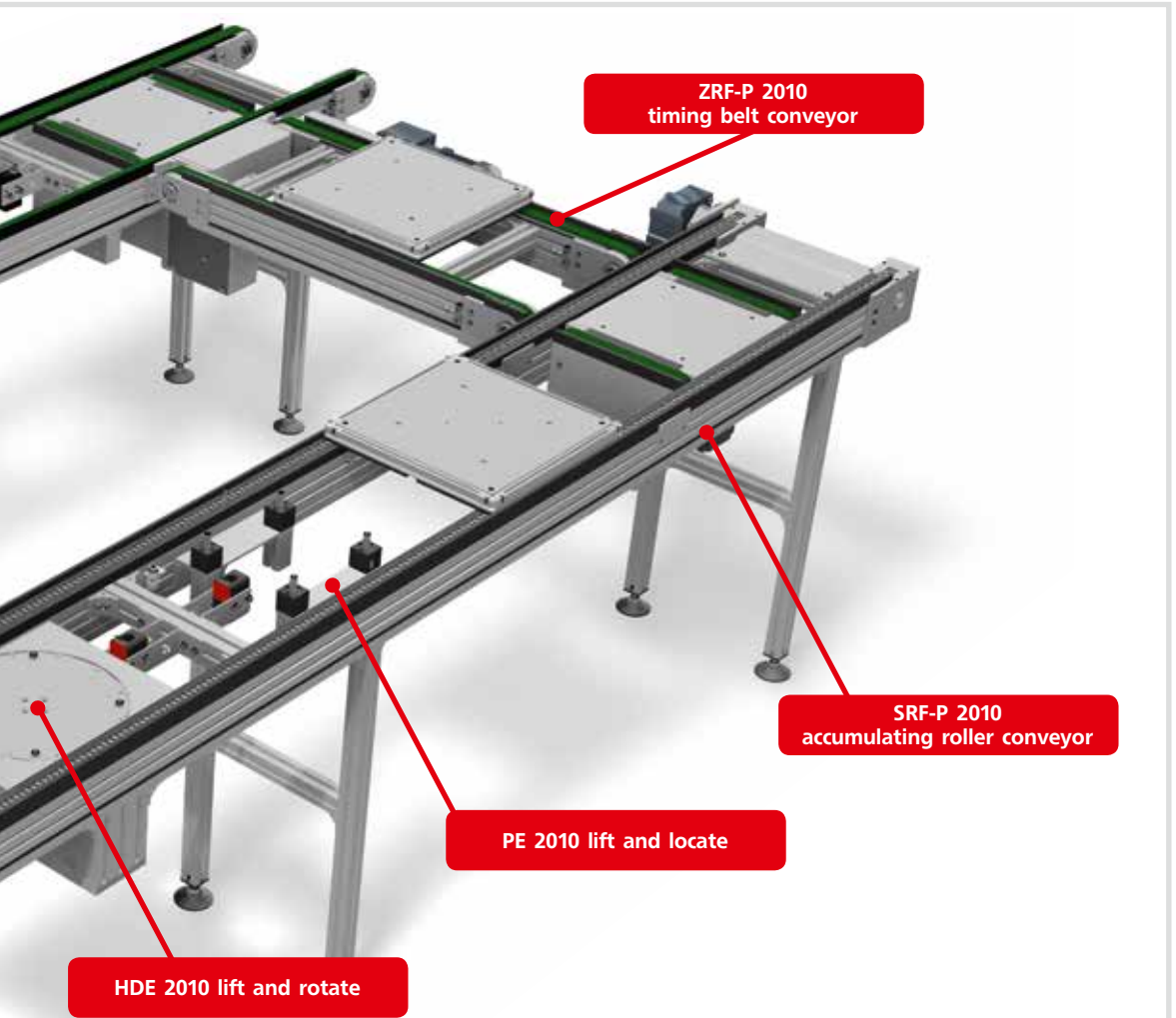

ZRF-P 2010
timing belt conveyor

SRF-P 2010
accumulating roller conveyor

PE 2010 lift and locate



HDE 2010 lift and rotate



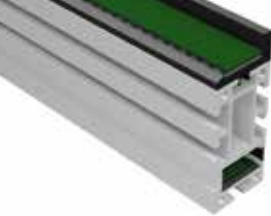

Applications

Automotive, appliance, vacuum technology,
consumer electronics, electronic, plastics industry, etc.

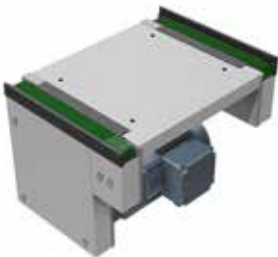

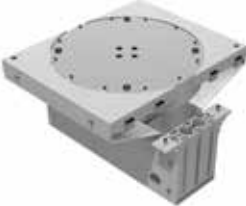
Versamove plus modules

	Features	Tech. data
WT 2010 pallet		
	<ul style="list-style-type: none"> ■ Aluminum surface plate (steel optional) ■ Locating bushings in surface plate for positioning and turning pallet (optional) ■ PE slide rails (anti-static optional) ■ Integrated damping bumpers 	<ul style="list-style-type: none"> ■ Up to zu 100 kg total load ■ Width: 400-800 mm ■ Length: 400-1040 mm
ZRF-P 2010 timing belt conveyor		
	<ul style="list-style-type: none"> ■ Conditionally suitable for accumulating operation ■ Especially well-suited for indexing operation ■ High acceleration ■ Reversing operation possible ■ Low-maintenance ■ Available in anti-static design as an option 	<ul style="list-style-type: none"> ■ Length: 500-6000 mm ■ Section load: 100 kg/m ■ Total load: 250 kg ■ Speeds: up to 60 m/min ■ PAR/PAZ coating
KTF-P 2010 chain conveyor		
	<ul style="list-style-type: none"> ■ Very rugged ■ High operating temperatures ■ Also for dirty environmental conditions ■ Reversing operation possible ■ Optional anti-static design 	<ul style="list-style-type: none"> ■ Length: 500-10000 mm ■ Section load: 150 kg/m ■ Total load: 1000 kg ■ Speeds: up to 30 m/min
SRF-P 2010 accumulating roller conveyor		
	<ul style="list-style-type: none"> ■ Especially well-suited for accumulating operation ■ High operating temperatures ■ Accumulating rollers available in steel and plastic ■ Available in anti-static design as an option 	<ul style="list-style-type: none"> ■ Length: 500-10000 mm ■ Section load: 150 kg/m ■ Total load: 750 kg ■ Speeds: up to 30 m/min
HQZ 2010 lift and transfer		
	<ul style="list-style-type: none"> ■ Low overall height ■ Pneumatic lifting movement ■ Guidance via linear ball guides ■ Manual belt tensioning included ■ Inductive position detection 	<ul style="list-style-type: none"> ■ Loads up to 100 kg ■ Speeds: 6; 9; 12; 15 and 18 m/min ■ Stroke: 25 mm

	Features	Tech. data
HDE 2010 lift and rotate		
	<ul style="list-style-type: none"> ■ Low overall height ■ Individual rotation speeds ■ Pneumatic lifting and rotating movement ■ Guidance using linear bearings and guide rods ■ Inductive position detection 	<ul style="list-style-type: none"> ■ Loads up to 100 kg ■ Rotating movement 90° and 180°
Stopper undamped SU/damped SD		
	<ul style="list-style-type: none"> ■ Undamped and damped stopping ■ Stopper querying possible electrically or inductively ■ Single or dual-acting 	<p>Permissible load is dependent on stopper version and conveying speed</p>
PE 2010 lift and locate		
	<ul style="list-style-type: none"> ■ Positioning in X, Y and Z-direction ■ Positioning via locating bushings in surface plate of pallets ■ Pneumatic lifting 	<ul style="list-style-type: none"> ■ Repeat accuracy: ± 0,1 mm ■ Cylinder stroke: 40 mm
KHL 2010 short stroke lift		
	<ul style="list-style-type: none"> ■ Moving between two transport elevations ■ Pneumatic lifting and lowering ■ Speeds are steplessly adjustable ■ Conveying type KTF, ZRF and SRF possible (ZRF shown here) 	<ul style="list-style-type: none"> ■ Effective load up to 100 kg
Maintenance access WTZ 2010		
	<ul style="list-style-type: none"> ■ Simple access to interior through lift-gate conveyor ■ Fast, safe maintenance ■ Gas spring secures against falling back ■ Safety switch protects against unauthorized access 	

Features

- ✓ Up to 300 kg total weight per pallet
- ✓ Pallet sizes: 600 x 600 to 1200 x 1200 mm
- ✓ Rugged and loadable for major tasks

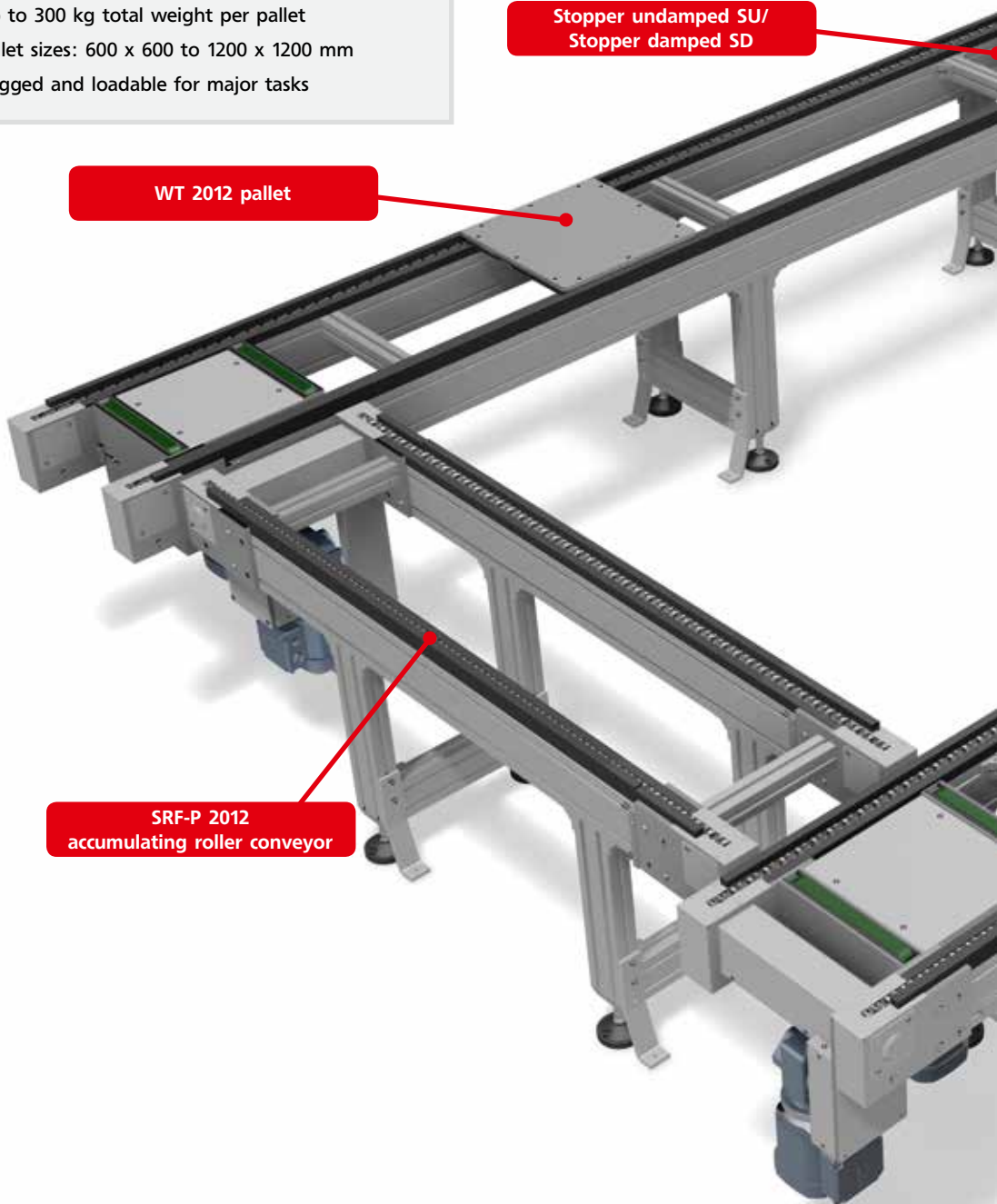

WT 2012 pallet

Stopper undamped SU/
Stopper damped SD

SRF-P 2012
accumulating roller conveyor

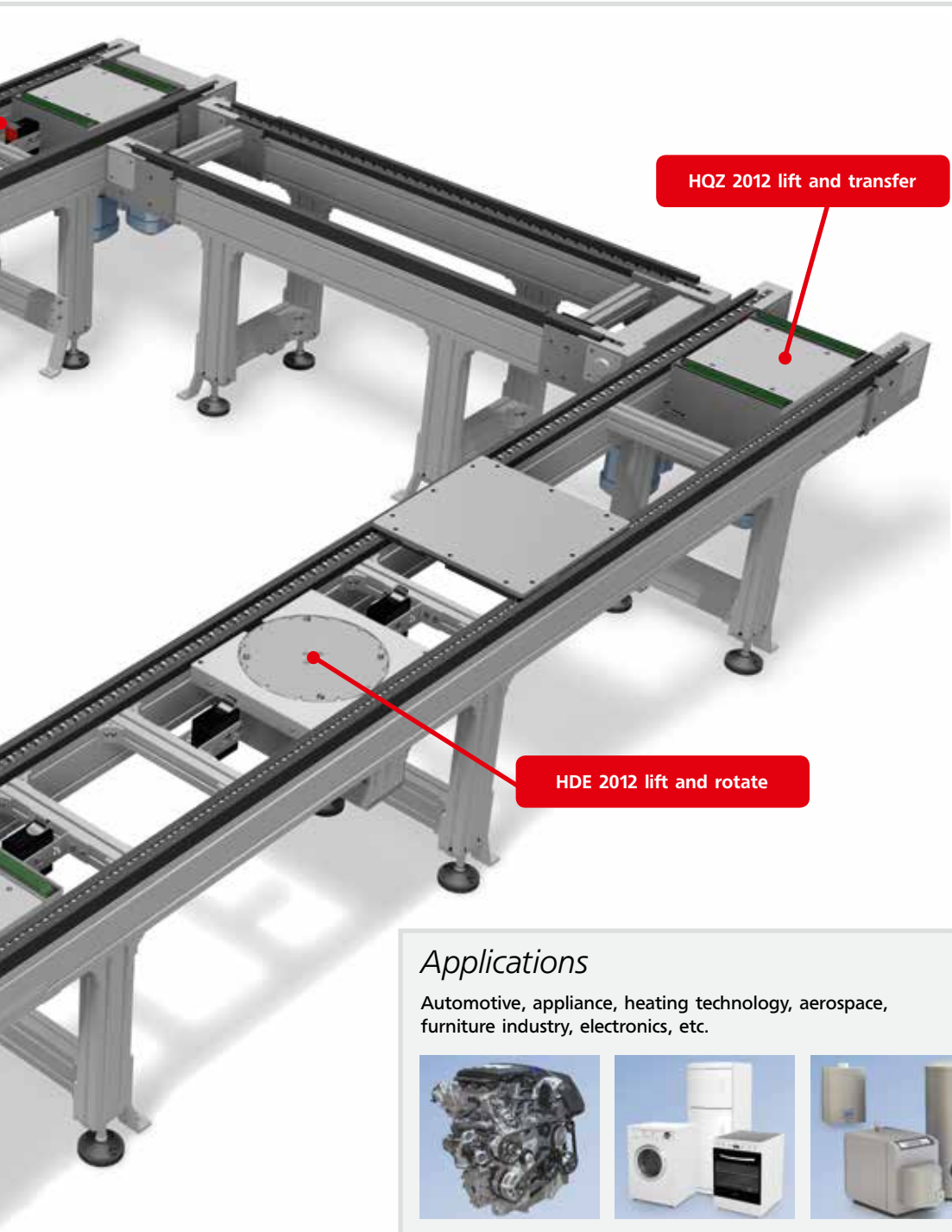





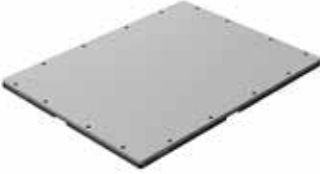

Applications

Automotive, appliance, heating technology, aerospace, furniture industry, electronics, etc.

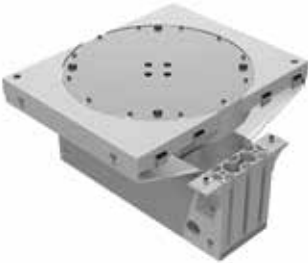

Versamove ultra modules

	Features	Tech. data
WT 2012 pallet		
	<ul style="list-style-type: none"> ■ Aluminum surface plate (steel optional) ■ Locating bushings in surface plate for positioning and turning pallet (optional) ■ Steel slide rails (plastic optional) ■ Integrated damping bumpers 	<ul style="list-style-type: none"> ■ Up to zu 300 kg total load ■ Width: 600-1200 mm ■ Length: 600-1200 mm
SRF-P 2012 accumulating roller conveyor		
	<ul style="list-style-type: none"> ■ Especially well-suited for accumulating operation ■ High operating temperatures ■ Accumulating rollers available in steel and plastic ■ Available in anti-static design as an option 	<ul style="list-style-type: none"> ■ Length: 1000-10000 mm ■ Section load: 150 kg/m ■ Total load: 1000 kg ■ Speeds: up to 30 m/min
HQZ 2012 lift and transfer		
	<ul style="list-style-type: none"> ■ Low overall height ■ Pneumatic lifting movement ■ Guidance using linear bearings and guide rods ■ Manual belt tensioning included ■ Inductive position detection 	<ul style="list-style-type: none"> ■ Loads up to 300 kg ■ Speeds: 6; 9; 12; 15 and 18 m/min ■ Stroke: 20 mm
HDE 2012 lift and rotate		
	<ul style="list-style-type: none"> ■ Low overall height ■ Individual rotating speeds ■ Pneumatic lifting and rotating movement ■ Guidance using linear bearings and guide rods ■ Inductive position detection 	<ul style="list-style-type: none"> ■ Rotating movement 90° and 180°

	Features	Tech. data
Stopper undamped SU/damped SD		
	<ul style="list-style-type: none"> ■ Undamped and damped stopping ■ Stopper querying possible electrically or inductively ■ Single or double-action actuation 	<p>Permissible load is dependent on stopper version and conveying speed</p>
PE 2012 lift and locate		
	<ul style="list-style-type: none"> ■ Positioning in X, Y and Z-direction ■ Positioning via locating bushings in surface plate of pallets ■ Inductive position detection ■ Pneumatic lifting 	<ul style="list-style-type: none"> ■ Repeat accuracy: ± 0,1 mm
KHL 2012 short stroke lift		
	<ul style="list-style-type: none"> ■ Moving between two transport elevations ■ Pneumatic lifting and lowering ■ Speeds are steplessly adjustable ■ Conveying type ZRF and SRF possible (ZRF shown here) 	<ul style="list-style-type: none"> ■ Effective load up to 300 kg

Application examples



Versamove plus: Transfer of pallets from main line onto two parallel spur lanes



**Versamove standard:
Stopper and lift and locate**

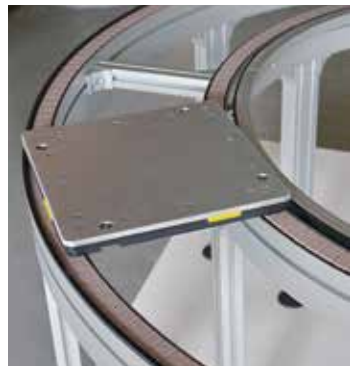

**Versamove standard:
Flat top chain conveyor curve**



Versamove standard: Lift and transfer with damped stop



Versamove standard
with custom pallets

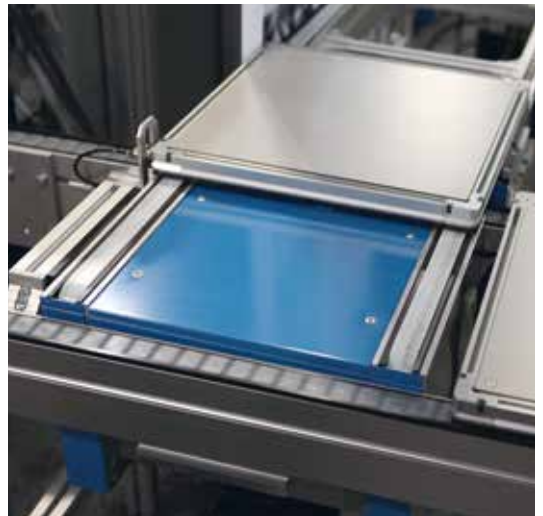

Versamove standard:
Lift and transfer with custom paint

Application examples



Versamove ultra: Customer-specific parallel circulation system with pallet transfers

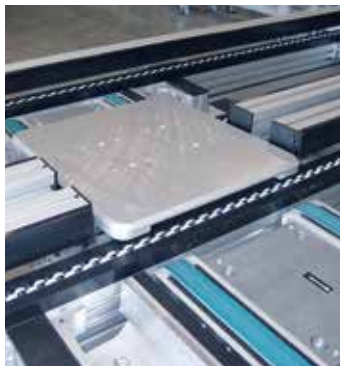

Versamove plus: Dual-lane system with special guide rails



Versamove standard: Central lubrication unit



Versamove plus: Customer-specific special stopper unit with four removal positions

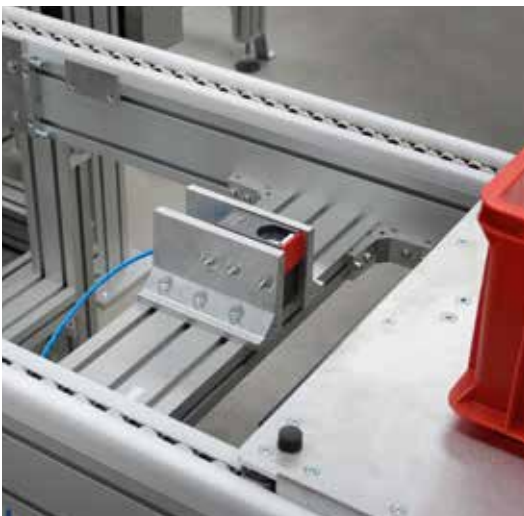

Versamove ultra: Accumulating roller conveyor with special chain guides for higher loading



Versamove plus: Two transport levels, accumulating roller conveyor



**Maschinenbau Kitz GmbH
Headquarters of the
mk Technology Group**

Ampèrestraße 18
53844 Troisdorf
Germany

Phone +49 228 4598-0
Fax +49 228 453145

www.mk-group.com
info@mk-group.com