

G series

Helical and bevel helical
gear reducers and gearmotors

Edition June 2016

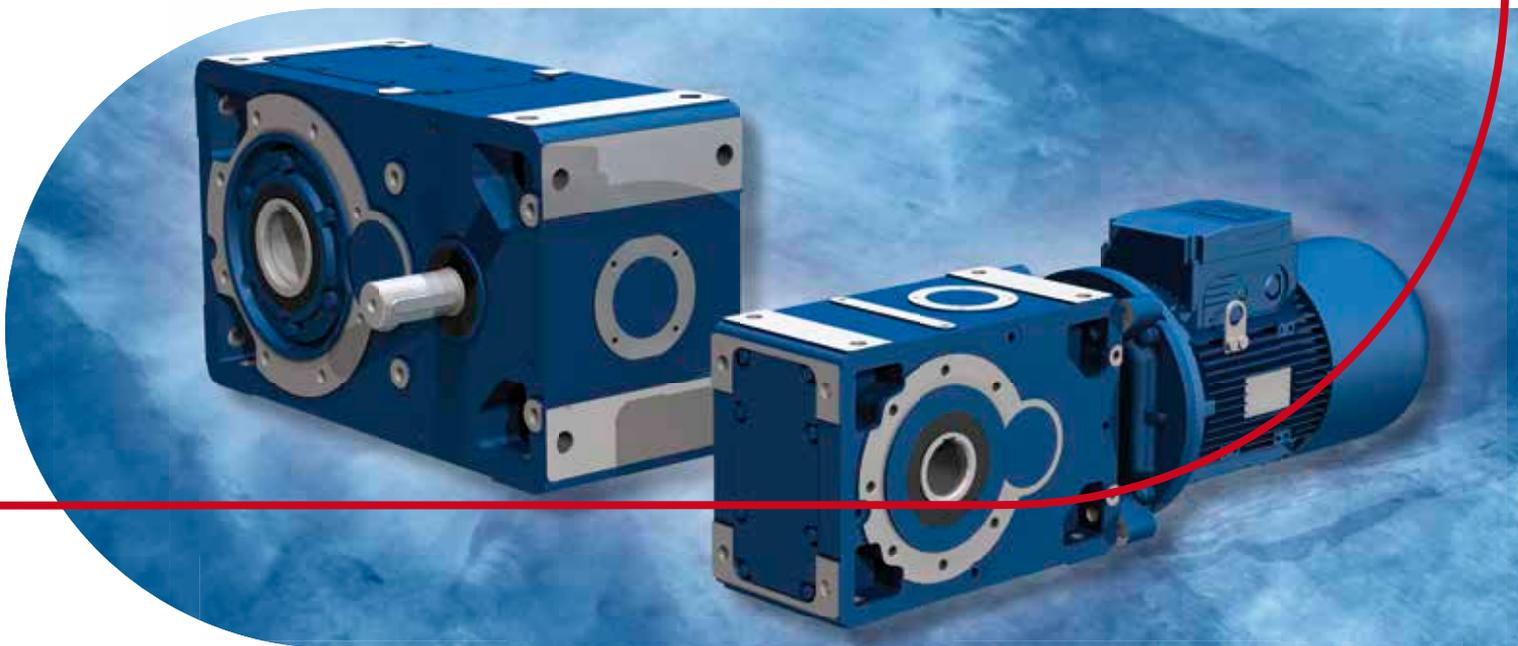

Size ¹⁾ M_{N2} [N m] - F_{r2} [kN]	I ²⁾	CI ⁴⁾	ICI	2I ⁵⁾	3I	2I «long»	3I «long»	C2I
40 ³⁾ 100 - 2,24								
50 206 - 3,15								
63 387 - 5								
64 487 - 5								
80 825 - 8								
81 975 - 8								
100 1 700 - 12,5								
125 3 450 - 20								
140 5 150 - 28								
160 7 750 - 35,5								
180 10 900 - 45								
200 15 500 - 56								
225 21 800 - 71								
250 31 500 - 90							²⁾	
280 43 700 - 112							²⁾	
320 54 500 - 140			²⁾				²⁾	
321 69 000 - 140			²⁾				²⁾	
360 87 500 - 180			²⁾				²⁾	

1) For larger sizes see cat. H.

2) Gear reducers, only.

3) Gearmotors only.

4) Also C3I sizes 50 ... 125 (gearmotors only).

5) Also 4I sizes 63 ... 125 (gearmotors only).



Overview	4	1
1 – General specifications	11	2
2 – Designation	19	3
3 – Service factor f_s	23	4
4 – Thermal power P_t [kW]	27	5
5 – Selection.....	31	6
6 – Structural and operational details	37	7
7 – Selection tables (helical gear reducers).....	49	8
8 – Dimensions, designs, mounting positions (helical gear reducers).....	109	9
9 – Selection tables (bevel helical gear reducers).....	129	10
10 – Dimensions, designs, mounting positions (bevel helical gear reducers)	197	11
11 – Selection tables (helical gearmotors)	209	12
12 – Dimensions, designs, mounting positions (helical gearmotors)	227	13
13 – Selection tables (bevel helical gearmotors).....	255	14
14 – Dimensions, designs, mounting positions (bevel helical gearmotors).....	277	15
15 – Combined gear units	293	16
16 – Radial loads	297	17
17 – Accessories and non-standard designs	321	18
18 – Installation and maintenance	359	

Your worldwide partner for high quality solutions

Who we are

In brief:

1953 Year of foundation as family business and today still privately owned



Rossi in the 70's

70's First in Italy to adopt a complete modular system for helical and bevel helical gear reducers; first in Italy to adopt case-hardened, tempered, ground gear pairs on helical and bevel helical gear reducers

80's Worm gear reducers and gearmotors with universal mounting, single-piece housing and ZI involute profile; extension of the direct sales organization abroad with the facilities of the German, English, French and Spanish subsidiaries.

90's Helical and bevel helical gear reducers and gearmotors with universal mounting and single-piece housing; first transmission manufacturer in Italy and second in Europe to obtain Quality System Certification ISO 9001.

1994 The only one to offer 3-year-warranty

1997 Acquisition of Seimec (Rossi Motor Division)

2002 Acquisition of SMEI (Rossi Planetary Gear Reducer Division, WIND)



Rossi Planetary Gear Reducer Division

2003 ISO 9001 – 2000 Standard (Vision 2000)

2004 New affiliated company in U.S.A.
Habasit acquires important share in Rossi, to reinforce global presence and develop growth strategy

2009 (July) Habasit Holding owns 100% Rossi

2010 Logo and Company name change: from "Rossi Motoriduttori S.p.A." to "Rossi S.p.A."



Rossi Industrial Gear Reducer Division, today

For more than 60 years we have been developing our business in the most demanding applications to become one of the world's leading gearmotor manufacturers suitable for critical machines. Even in the toughest environment, we are recognized for providing state of the art technology, solid value, and commitment to our customers.

Where you can find us

Close to you in all five continents, with a direct sales system granting excellence in service: visit our new website for your country reference.

We are where you need us to be.

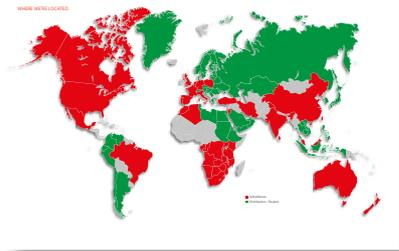

What we believe in

Choosing the drive with the right technical specifications is vital for reliability and economy.

We believe in integrity, ethical behavior, knowledge, imagination, innovation, good teamwork and above all customer focus: these are some of our major key success factors.

We are a reliable company with the right flexibility and know-how to respond to all market requests, all over the world, in all application fields, without leaving aside our commitment for the environment and value on human safety, to protect everyone's future.



What we can do for you

A highly skilled specialist team in different fields, Industry Segment Managers providing customers with the right support to find the best solution suitable for your demands, and accompany you step by step alongside the whole supply.



What you can do for us, to help us improve

You are at the centre of all we do; that is why we want your feedback and suggestions on how we can improve.

Providing us with news and information in your market sector along with any improvements you feel will enhance our service offering.

We regard this relationship as a partnership and look for mutual benefits that will enhance this partnership at all times.



Who you can call

A well-organized after-sale service providing problem solving in the quickest possible way

Rossi for You portal, allowing you to have 24/7 access to all the documentations concerning our supplies, news and order tracking in real time.



What we do

Our wide standard product range and design, allowing a universal and flexible application, allows us to provide you with the right solution for every application including a 3 year warranty, worldwide.



Gearmotors

Type of gear		Catalog
Worm gearmotors		A
Standardfit worm gearmotors		AS
Coaxial gearmotors		E
Standardfit coaxial gearmotors		ES
Helical and bevel-helical gearmotors		G
Planetary (in line and bevel helical) gearmotors		EP

Gear reducer

Type of gear		Catalog
Worm gear units		A
Helical gear units		G
Bevel-Helical gear units		G
Heavy duty helical gear units		H
Heavy duty bevel-helical gear units		H
Planetary (in line and bevel helical) gear units		EP
Right angle shaft gear units		L
Shaft mounted helical gear units		P

Motors

Type		Catalog
Asynchronous three-phase high efficiency and premium efficiency motors		TX
Standard and high efficiency brake motors		TX
Heavy duty roller table motors		S

Motion control

Type		Catalog
Worm, coaxial, helical and bevel helical servo gear units		SR
Low backlash planetary servo gear units		SM

Specific industrial segments

Type		Catalog
Extruders, Helical gear reducers and gearmotors		GX
Wind drives, Pitch and Yaw drives		EPW
Slewing drives		EPS
Combined gear units		
Heavy duty, Drive units on swing base		RE
HyCLEAN solution (food and beverage, chemical)		HyCLEAN
Heavy duty roller table motors		S

Features and **Benefits**

Cutting edge design, state of the art manufacturing process and safety deriving from our long expertise on the field:

- rational, modern and essential design
- cast iron single piece housing with high structural stiffness
- cylindrical and bevel gear pairs ground in a very high quality class and optimized geometry
- design and calculation of every single component
- high torsional rigidity and reduced angular backlash

- **High and long lasting performance**
- **Smooth and quiet running**
- **Precision and repeatability of low speed shaft angular positioning**

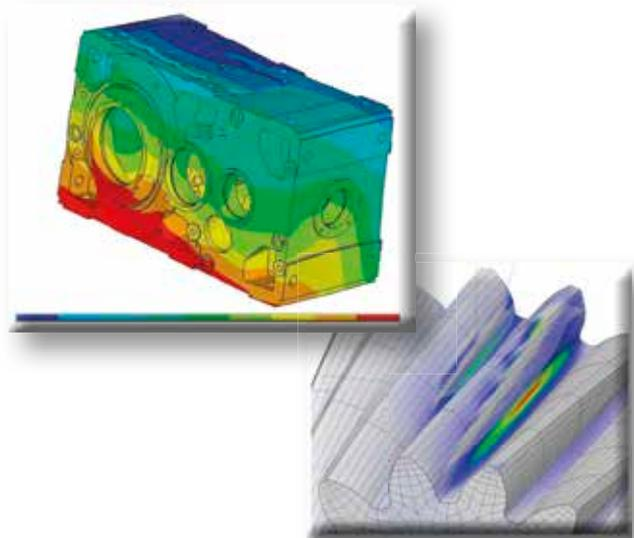

- Extensive use of the modular system: same installation dimensions (low speed shaft diameter, shaft height, foot dimensions, etc.) at the same gear reducer size and independently from the train of gears
- Thick and regular scaling of the product range
- Gearmotors with input coupling dimensions according to IEC standards

- **Easy and economic application**
- **Freedom of selection for designers**
- **Certainty of the right economical choice**
- **Electric motor easily suppliable**

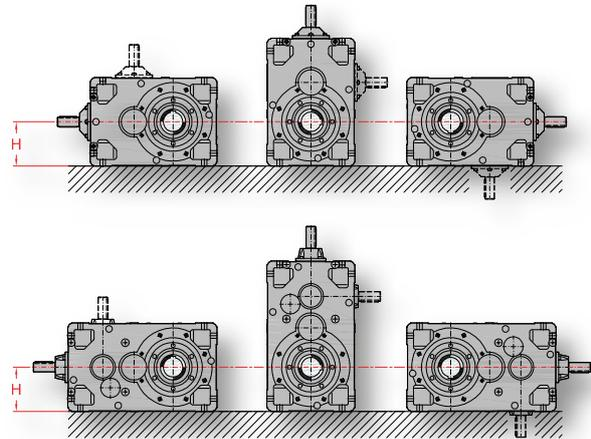

- Wide customization possibility (e.g.: low speed shaft designs, monitoring and sensors, reaction systems for shaft mounting, forced cooling systems, oil seal typologies, etc.)
- Maximum application flexibility

- **Products easily customizable starting from a standard manufacturing program**
- **Easy and economic application**
- **Easy maintenance**

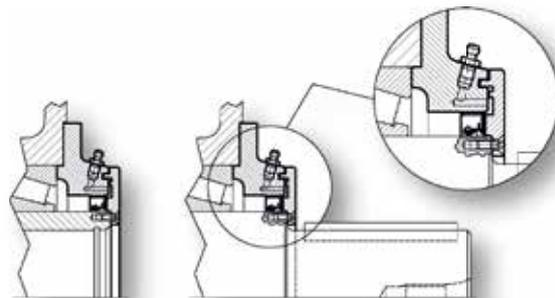

Strong experience in the supply of complete drive units (cat. RE)

- **Turn key drive units**
- **One partner for every technical and commercial aspect**
- **Reduction of design time**
- **Simplification of installation on site**
- **Possibility of combined units with different Rossi products (e.g.: planetary)**



Features and **Benefits**

Skilled technical service supporting the Customer in the selection of the most competitive application solution, thanks to:

- assistance and technical support during the design phase of machine and selection of gear reducer unit
- technical calculations and verifications using cutting edge calculation tools
- **Performance verified and granted according to the heaviest load conditions**
- **Selection optimization in terms of performance, reliability and costs**
- **Customized solutions verified through a long application experience**

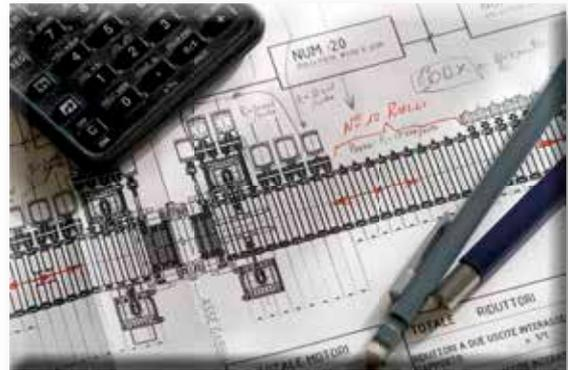

New web portal especially created for our Customers
You can easily access to:

- order confirmations
- order tracking
- invoicing documents
- spare part tables
- specific technical documentation
- **Online order tracking, starting from order processing to delivery**
- **Commercial and technical information easily accessible**



- Purchasing, machining, assembling and control processes to quality system ISO 9001 and certified by TÜV NORD
- Gear reducers assembled and tested on bench by skilled personnel

- **High quality and reliability standards**
- **Constant performance**
- **3 years warranty, from 1997**



Global service:

- 16 subsidiaries
- 50 importers
- **Worldwide network at your service**



Symbols and units of measure

Symbols used in the catalog and formulae, in alphabetical order, with relevant units of measure.

Symbol	Definition	Units of measure			Notes
		In the catalog	In the formulae		
			Technical System	SI ¹⁾ System	
	dimensions	mm	–		1 inch (in) = 24,5 mm; 1 foot (ft) 30,48 cm
<i>a</i>	acceleration	–	m/s ²		
<i>d</i>	diameter	–	m		
<i>f</i>	frequency	Hz	Hz		
<i>f_s</i>	service factor				
<i>f_t</i>	thermal factor				
<i>F</i>	force	–	kgf	N ²⁾	1 kgf ≈ 9,81 N ≈ 0,981 daN
<i>F_r</i>	radial load	N	–		
<i>F_a</i>	axial load	N	–		
<i>g</i>	acceleration of gravity	–	m/s ²		normal value 9,81 m/s ²
<i>G</i>	weight (weight force)	–	kgf	N	1 pound (lbf) = 4,4482 N
<i>Gd²</i>	dynamic moment	–	kgf m ²	–	
<i>i</i>	transmission ratio				$i = \frac{n_1}{n_2}$
<i>I</i>	electric current	–	A		
<i>J</i>	moment of inertia	kg m ²	–	kg m ²	
<i>L_n</i>	bearing life	h	–		
<i>m</i>	mass	kg	kgf s ² /m	kg ³⁾	
<i>M</i>	torque	N m	kgf m	N m	1 kgf m ≈ 9,81 N m ≈ 0,981 daN m
<i>M_f</i>	braking torque	N m	kgf m	N m	1 kgf m ≈ 9,81 N m ≈ 0,981 daN m
<i>n</i>	angular speed	min ⁻¹	rev/min	–	1 min ⁻¹ ≈ 0,105 rad/s
<i>P</i>	power	kW	CV	W	1 CV ≈ 736 W ≈ 0,736 kW
<i>P_t</i>	thermal power	kW	–		
<i>r</i>	radius	–	m		
<i>R</i>	variation ratio				$R = \frac{n_{2 \max}}{n_{2 \min}}$
<i>s</i>	distance	–	m		
<i>t</i>	Celsius temperature	°C	–		1 °F = 1,8 · °C + 32
<i>t</i>	time	s min h d	s		1 min = 60 s 1 h = 60 min = 3 600 s 1 d = 24 h = 86 400 s
<i>U</i>	voltages	V	V		
<i>v</i>	velocity	–	m/s		
<i>W</i>	work, energy	MJ	kgf m	J ⁴⁾	
<i>z</i>	frequency of starting	starts/h	–		
<i>α</i>	angular acceleration	–	rad/s ²		
<i>η</i>	efficiency				
<i>η_s</i>	static efficiency				
<i>μ</i>	friction coefficient				
<i>φ</i>	plane angle	°	rad		1 rev = 2 π rad $1^\circ = \frac{\pi}{180}$ rad
<i>ω</i>	angular velocity	–	–	rad/s	1 rad/s ≈ 9,55 min ⁻¹

Additional indexes and other signs

Ind.	Definition
max	maximum
min	minimum
N	nominal
1	relating to high speed shaft (input)
2	relating to low speed shaft (output)
÷	from ... to
≈	approximately equal to
≥	greater than or equal to
≤	less than or equal to

- 1) SI are the initials of the International Unit System, defined and approved by the General Conference on Weights and Measures as the only system of units of measure.
See CNR UNI 10 003-84 (DIN 1 301-93 NF X 02.004, BS 5 555-93, ISO 1 000-92).
UNI: Ente Nazionale Italiano di Unificazione.
DIN: Deutscher Normenausschuss (DNA).
NF: Association Française de Normalisation (AFNOR).
BS: British Standards Institution (BSI).
ISO: International Organization for Standardization.

- 2) Newton [N] is the force imparting an acceleration of 1 m/s² to a mass of 1 kg.
3) Kilogramme [kg] is the mass of the prototype kept at Sèvres (i.e. 1 dm³ of distilled water at 4 °C).

Joule [J] is the work done when the point of application of a force of 1 N is displaced through a distance of 1 m.

1 – General specifications

1 - General specifications

Universal «symmetrical» mounting: suitable for horizontal or vertical mounting

Rigid and precise cast iron single-piece housing; high oil capacity

Standard hollow low speed shaft, prearranged for installation of backstop device, option of double extension high speed shaft

Possibility of fitting particularly powerful motors and capability of withstanding high loads on the shaft end

Possibility of obtaining multiple drivers without restrictions on direction of rotation

Intermediate sizes 140, 180, 225, 280, 360 – dimensions similar to previous sizes 125, 160, 200, 250, 320 – **conceived to be also a supporting series in particular applications; three size pairs**, standard and strengthened, **63 and 64, 80 and 81, 320 and 321**

Manufacturing and product management flexibility

High manufacturing quality standards

Minimum maintenance requirements

IEC motor

High, reliable and tested performance

Wide range of sizes, trains of gears and solutions.

“Long” series of helical gear reducers and gearmotors for applications with U position of motor/machine shaft and considerable distance between input and output shafts; same input and output coupling dimensions, same transmission ratios and performances, same combinations of motors and gear reducers as the standard series (**patent pending**).

This series of gear reducers and gearmotors combines and exalts the traditional qualities of helical and bevel helical gear reducers – **strength, accuracy, and reliability** – with advantages derived from modern design, manufacturing and operating criteria – **suitability for the heaviest duties, universality and ease of application, comprehensive size range, service, economy** – the advantages typically associated with high quality gear reducers produced in large series.

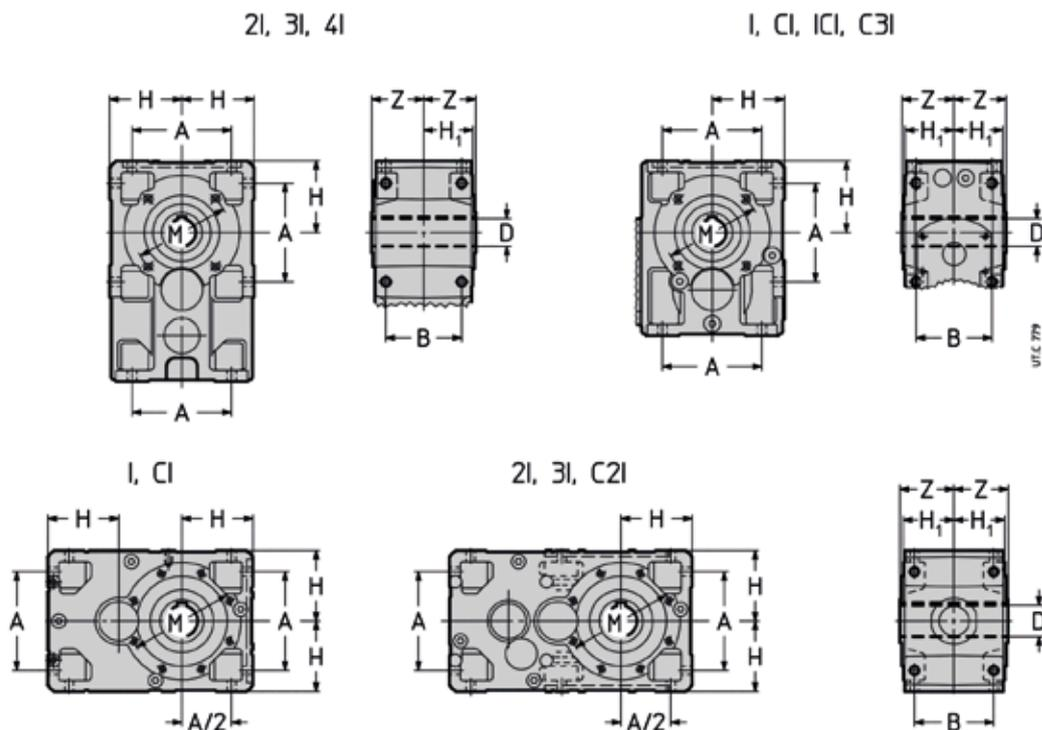

Fully interchangeable gear reducers – of the same size – independently from train of gears.

1.1 - Gear reducer

Main structural features

- **universal** mounting having feet integral with housing on 4 faces (3 faces for train of gears: I sizes 63 ... 100, CI sizes 40 ... 100, C3I, ICI) and B14 flange on 2 faces (1 face for standard model 2l, 3l and 4l sizes 40 ... 125); gear reducers and gearmotors 2l, 3l sizes 40 ... 125 and 4l sizes 63 ... 125 having reaction recess for shaft mounting arrangement (see ch. 6), B5 flange with spigot recess mountable on the faces with B14 flange (see ch. 17); the drawing and the strength of housing allow **interesting shaft mounting arrangements**, foot mounted motor coupling arrangement (see ch. 18) and attachments points for a variety of equipment;
- gear reducer overall dimensions are suitable to be equipped with large motor sizes transmitting **high nominal and maximum torques**, supporting **high loads on low and high speed shaft ends**;
- standard hollow low speed shaft in steel, with keyway and retaining ring grooves for extraction (excluding sizes 40 ... 63); standard (left or right hand extension) or double extension low speed shaft (see ch. 17).

1 - General specifications

- gearmotors MR 4I (sizes 63 ... 125), MR C3I (sizes 50 ... 125) with **first reduction stage** including **2** coaxial cylindrical gear pairs in order to get high transmission ratio, with standardized motor, in an economic and compact way;
- improved and upgraded modular construction both for component parts and assembled product;
- standardized dimensions and compliance with standards;
- gear reducers: input face with machined surface (flange for R 3I 63 ... 125, R ICI) with fixing holes, high speed shaft end with key;
- gearmotors MR 3I 40 ... 125, MR 4I, MR ICI and MR C3I: first reduction pinion gear directly keyed onto the shaft end of **IEC standard motor**;
- gearmotors MR 2I, MR 3I 140 ... 360, MR CI, MR C2I: **IEC standard motor** directly fitted into hollow high speed shaft; with **motor size ≥ 200** , to obtain easier installing and removal and avoid fretting corrosion, bevel helical gearmotors (CI, C2I) have a keying system with key and bronze bushing whereas helical gearmotors (2I, 3I) have a keying system with hollow high speed shaft with longitudinal cuts, shrink disc and key for a perfect alignment;
- possibility of **second high speed shaft extension** (or intermediate shaft extension for train of gears 3I 40 ... 125, 4I, ICI, C3I);
- taper roller bearings, excluding some shafts (high speed shaft) on which bearings are cylindrical roller or ball type;
- **cast iron** single-piece housing 200 UNI ISO 185 (**spheroidal** UNI ISO 1083 for sizes 140, 180, 225, 280, 360) with **stiffening ribs and high oil capacity**;
- oil bath lubrication; synthetic oil, providing lubrication **«for life»** and 1 plug (sizes 40 ... 64) or 2 plugs (sizes 80 and 81), **filled with oil** (sizes 40 ... 81); synthetic or mineral oil (ch. 18) with filler plug and valve, level and drain plug, supplied **without oil** (sizes 100 ... 360); sealed;
- additional bearings lubrication through proper pipelines or pump (sizes 100 ... 360);
- natural or forced cooling (fan – also in **flange** mounting – and/or coil, see ch. 17);
- **paint: external** coating in epoxy powder paint (sizes 40 ... 81) or water based dual compound polyurethane enamel (sizes 100 ... 360) resistant to atmospheric and aggressive agents (corrosivity category C3 ISO 12944-2); suitable for further coats only with dual-compound products after degreasing and sanding; color blue RAL 5010 DIN 1843, other colors and/or painting cycles on request see ch. 17); **internal** protection with epoxy powder paint (sizes 40 ... 81) suitable to resist to synthetic oils or with synthetic paint (sizes 100 ... 360) suitable to resist polyalphaolefines based synthetic or mineral oils.
- possibility to obtaining combined gear reducer and gearmotor units providing high transmission ratios;
- non-standard designs: backstop device (always pre-arranged, excluding size 40 and helical size 50), stepped hollow low speed shaft, supplementary cooling and lubrication systems, shaft mounting arrangements, special paints, **ATEX II 2 GD** and **3 GD**, design for agitators, etc. (ch. 17).
- **helical «long» model**: it is derived from the standard one (completing it) through the addition of an **idle gear** between wheel and pinion of the second-last reduction stage (first reduction stage for 2I train of gears) hence allowing to **distance considerably** the input and output shafts, whilst maintaining the same **specifications and performances** as the standard model. In particular:
 - same **input and output coupling dimensions** (shafts and B14 output flange, motor sizes);
 - same high speed shaft **bearing** (shafts and bearings) with the same transmission ratio;
 - same **foot mounting dimensions** (A_1 dimension excluded);
 - same **transmission ratios and performances**;
 - same **combinations of motors and gear reducers**;
 - same **thermal power** (thanks to the greater length of the housing);
 - same **accessories** and non-standard **designs**;
 - same **high quality level** (design solutions, production processes and tests, components, single-piece housing, modular and aesthetic design).

The «long» gear reducer obtained through this new design concept, makes possible also very low transmission ratios with proportioned and generous bearings in terms of high speed shaft roller bearings and shaft diameters.

Everything stated in this catalog is to be intended **valid both for standard and long model**, except otherwise stated.

Comparison between gear reducer R 2I 250 standard type UP2D and relevant long type **UP4D (patent pending)**: highlighting the extension of center distance, the presence of the idle gear and the reversing of rotation direction.

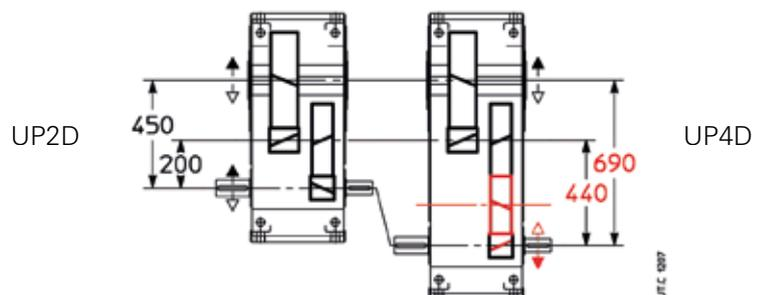

1 - General specifications

Train of gears

- 1, 2, 3, 4 helical gear pairs (helical gear reducers);
- 2, 3 helical gear pairs and **1 idle gear** («long» model, helical gear reducers);
- 1 bevel gear pair plus 1, 2, 3 helical gear pairs (bevel helical gear reducers);
- 6 sizes with final reduction center distance to R 10 (40 ... 125, with 2 size pairs: standard and strengthened); 9 sizes with final reduction center distance to R 20 (140 ... 360, with 1 size pair: standard and strengthened), for a total of **18 sizes**;
- nominal transmission ratios to R 10 ($i_N = 2,5 \dots 160$; $i_N = 80 \dots 400$ for 4I) for helical gear units; to R 10 ($i_N = 5 \dots 200$; $i_N = 80 \dots 500$ for C3I) for bevel helical gear units; to R 20 ($i_N = 9 \dots 90$), excluding I and ICI, for all sizes 140 ... 360;
- casehardened and hardened gear pairs in 16 CrNi4 or 20 MnCr5 steel (depending on size) and 18 NiCrMo5 according to UNI EN 10084;
- helical gear pairs with **ground** profile;
- GLEASON spiral bevel gear pairs with **ground** or accurately lapped profile;
- gear load capacity calculated for tooth breakage and pitting.

Specific standards

- nominal transmission ratios and principal dimensions according to UNI 2016 (DIN 323-74, NF X 01.001, BS 2045-65, ISO 3-73);
- tothing profile to UNI 6587-69 (DIN 867-86, NF E 23.011, BS 436.2-70, ISO 53-74);
- shaft heights to UNI 2946-68 (DIN 747-76, NF E 01.051, BS 5186-75, ISO 496-73);
- fixing flanges B14 and B5 (the latter with spigot «recess») taken from UNEL 13501-69 (DIN 42948-65, IEC 72.2);
- medium series fixing holes to UNI 1728-83 (DIN 69-71, NF E 27.040, BS 4186-67, ISO/R 273);
- helical shaft ends (long or short) to UNI ISO 775-88 (DIN 748, NF E 22.051, BS 4506-70, ISO/R775) with tapped butt-end hole to UNI 9321 (DIN 332 BI. 2-70, NF E 22.056) excluding correspondence d-D;
- parallel keys UNI 6604-69 (DIN 6885 BI. 1-68, NF E 27.656 and 22.175, BS 4235.1-72, ISO/R/773-69) except for specific cases of motor-to-gear reducer coupling where key height is reduced;
- mounting positions derived from CEI 2-14 (DIN EN 60034-7, IEC 34.7);
- load capacity verified according to UNI 8862, DIN 3990, AFNOR E 23-015, ISO 6336; thermal capacity verified.

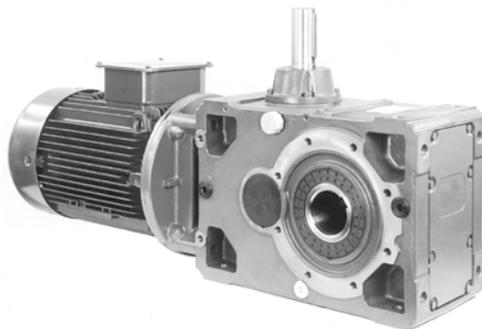

Bevel helical gearmotor CI (also C2I) with high speed shaft for **90° multiple drives**.



Helical gearmotor with **backstop device** (always prearranged)

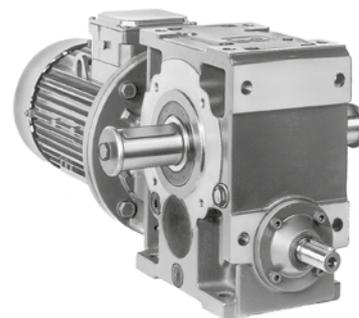

Bevel helical gearmotor ICI (also CI) with double extension low speed shaft and **high speed shaft extension** (design UO3D).

1 - General specifications

1.2 - Electric motor

Gearmotor dimensions and masses of present catalog (see ch. 12 and 14) refer to HB and HBZ motors (cat. TX).

Main structural features (HB motor and HBZ brake motor)

- motor **standardized to IEC**;
- asynchronous three-phase, totally-enclosed, externally ventilated, with cage rotor;
- single polarity, frequency 50 Hz, voltage Δ 230 V Y 400 V (size \leq 132), Δ 400 V (size \geq 160);
- **IP 55** protection, **insulation class F**, temperature rise class **B**;
- rated power delivered on continuous duty S1 (excluding some cases of motor sizes with power not according to standard; see specific documentation) and referred to nominal voltage and frequency; maximum ambient temperature 40 °C and altitude 1 000 m;
- capacity to withstand one or more overloads up to 1,6 times the nominal load for a maximum total period of 2 min per single hour;
- starting torque with direct on-line start at least 1,6 times the nominal one (it is usually higher);
- mounting position B5 and derivatives as shown in the following table;
- **suitable for inverter duty** (generous electromagnetic sizing, low-loss electrical stamping, phase separators, etc.)
- designs available for every application need: flywheel, independent cooling fan, independent cooling fan and encoder, etc.

1

Constructive features of HBZ brake motor

- particularly strong construction to withstand braking stresses; **maximum reduction of noise level**;
 - spring-loaded d.c. electromagnetic brake; feeding from the terminal box; brake can also be independently fed directly from the line;
 - braking torque proportioned to motor torque (usually $M_f \approx 2 M_N$) and adjustable by adding or removing spring pairs;
 - possibility of high frequency of starting;
 - quick and rapid stop;
 - hand lever for manual release with automatic return (on request for size \leq 160S); removable lever rod.
- For other specifications and details see **specific documentation of cat. TX**.

Main coupling dimensions

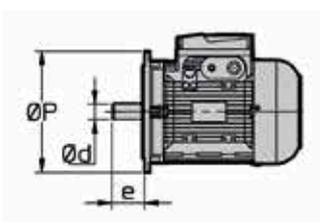
Motor size						
	IEC 60072 (UNEL 13117-17, DIN 43677 Bl. 1.A-65)					
	Motor mounting position					
	IM B5		B5R		B5A	
	Ød	x e - ØP	Ød	x e - ØP	Ød	x e - ØP
63	11	x 23 - 140	-	-	-	-
71	14	x 30 - 160	11	x 23 - 140	14	x 30 - 140
80	19	x 40 - 200	14	x 30 - 160	19	x 40 - 160
90	24	x 50 - 200	19	x 40 - 200	-	-
100, 112	28	x 60 - 250	24	x 50 - 200	-	-
132	38	x 80 - 300	28	x 60 - 250	-	-
160	42	x 110 - 350	38	x 80 - 300	-	-
180	48	x 110 - 350	-	-	-	-
200	55	x 110 - 400	48	x 110 - 350	-	-
225	60	x 140 - 450	-	-	-	-
250	65	x 140 - 550	60	x 140 - 450	-	-
280	75	x 140 - 550	-	-	-	-
315	80	x 170 - 660	75	x 140 - 550	-	-

1 - General specifications

Short time duty (S2) and intermittent periodic duty (S3); duty cycles S4 ... S10

In case of a duty-requirement type S2 ... S10 the motor power can be increased as per the following table; starting torque keeps unchanged.

Short time duty (S2). – Running at constant load for a given period of time less than that necessary to reach normal running temperature, followed by a rest period long enough for motor's return to ambient temperature.

Intermittent periodic duty (S3). – Succession of identical work cycles consisting of a period of running at constant load and a rest period. Current peaks on starting are not to be of an order that will influence motor heat to any significant extent.

$$\text{Cyclic duration factor} = \frac{N}{N + R} \cdot 100\%$$

where: N being running time at constant load,
 R the rest period and $N + R = 10$ min (if longer consult us).

Duty			Motor size ¹⁾		
			63 ... 90	100 ... 132	160 ... 315
S2	duration of running	90 min	1	1	1,06
		60 min	1	1,06	1,12
		30 min	1,25	1,18	1,25
		10 min	1,25	1,25	1,32
S3	cyclic duration factor	60%	1,12		
		40%	1,18		
		25%	1,25		
		15%	1,32		
S4 ... S10			consult us		

1) For motor sizes 90LC 4, 112MC 4, 132MC 4, consult us.

Frequency 60 Hz

Normal motors up to size 132 wound for 50 Hz can be fed at 60 Hz; in this case speed increases by 20%. If input-voltage corresponds to winding voltage, power remains unchanged, providing that higher temperature rise values are acceptable and that the power requirement is not unduly demanding, whilst starting and maximum torques decrease by 17%. If input-voltage is 20% higher than winding voltage, power increases by 20% whilst starting and maximum torques keep unchanged.

For brake motors, see specific literature.

From size 160 upwards motors – both standard and brake ones – should be wound for 60 Hz exploiting the 20% power increase as a matter of course.

Power available with high ambient temperature or high altitude

When motor has to run at an ambient temperature higher than 40 °C or at altitude above sea level higher than 1 000 m, it has to be derated according to the following tables:

Ambient temperature [°C]	30	40	45	50	55	60
P/P_N [%]	106	100	96.5	93	90	86,5

Altitude a.s.l. [m]	1 000	1 500	2 000	2 500	3 000	3 500	4 000
P/P_N [%]	100	96	92	88	84	80	76

1 - General specifications

Electric motor specific standards

- nominal powers and dimensions to CENELEC HD 231 (IEC 72-1, CNR-CEI UNEL 13117-71 and 13118-71, DIN 42677, NF C 51- 120, BS 5000-10 and BS 4999-141) for mounting positions IM B5, IM B14 and derivatives;
- nominal performances and running specifications to CENELEC EN 60034-1 (IEC 34-1, CEI EN 60034-1, DIN VDE 0530-1, NF C51- 111, BS EN 60034-1);
- protection to CENELEC EN 60034-5 (IEC 34-5, CEI 2-16, DIN EN 60034-5, NF C51-115, BS 4999-105);
- mounting positions to CENELEC EN 60034-7 (IEC 34-7, CEI EN 60034-7, DIN IEC 34-7, NF C51-117, BS EN 60034-7);
- sound levels to CENELEC 60034-9 (IEC 34.9, DIN 57530 pt. 9);
- balancing and vibration velocity (vibration under standard rating N) to CENELEC HD 53.14 S1 (IEC 34-14, ISO 2373 CEI 2-23, BS 4999-142); motors are balanced with half key inserted into shaft extension;
- cooling to CENELEC EN 60034-6 (CEI 2-7, IEC 34-6): standard type IC 411; type IC 416 for non-standard design with axial independent cooling fan.

1

1 - General specifications

HB - Asynchronous three-phase motor

Cutting edge technology motor including **the same stator winding**, the same **rotors**, the same **housings** and **flanges**, the same performance and main technical solutions of the twin series of brake motors (**HBZ, HBF, HBV**).

The strength and precision of the mechanical construction, the generous bearings and the comprehensive non-standard design range make this motor particularly suitable for the coupling with gearmotors.



1 HBZ - Asynchronous three-phase brake motor with d.c. brake

Thanks to the **smooth, progressive** and **dynamic** running, this motor is particularly suitable for the **coupling with gearmotor, minimizing the dynamic overloads** deriving from **starting and braking phases** (especially in case of motion reversals) but allowing an **excellent braking torque value**.

The excellent **operation progressivity** - when starting and braking - is assured by the brake anchor which is lighter (compared to the type in alternate current HBF) and less quick in the impact and by the slight quickness of d.c. brakes.

Offering a comprehensive range of accessories and non-standard designs (e.g.: IP 56, IP 65, flywheel, encoder, independent cooling fan, independent cooling fan and encoder, second shaft end, integrated motor-inverter, etc.).

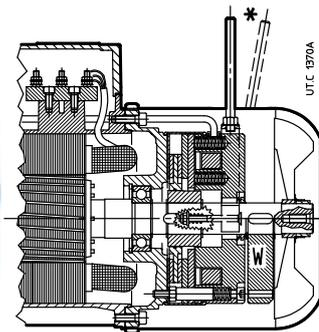

* on request.

HBF - Asynchronous three-phase brake motor with a.c. brake

The **extreme reactivity** typical of **a.c. brakes** and the **high braking frequency** make this brake motor **particularly suitable for heavy duty cycles** where **quick brakings** and **high number of operations are required** (e.g.: liftings with very frequent operations).

Viceversa its **high dynamic specifications** (quickness and operation frequency) generally **do not recommend the use** when coupling with **gearmotor** especially when these specifications are not strictly necessary for the application (in order to avoid any useless overloads on the drive).

Including the widest **range of non-standard designs and accessories** (e.g.: IP 56, IP 65, encoder, independent cooling fan, independent cooling fan and encoder, second shaft end, integrated motor-inverter, etc.).

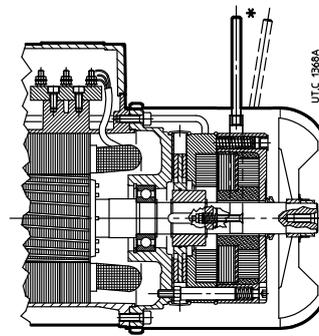

* on request.

HBV - Asynchronous three-phase brake motor with d.c. safety brake

Featuring **maximum economy, very reduced dimensions and moderate braking torque**, it is suitable for the coupling with gearmotor and has its typical application field where a brake is required for **safety or parking stops** in general (e.g.: cutting machines) and for operations at the end of the deceleration ramp during **running with inverter**.

Moreover, the cast iron fan provided as standard, supplies a flywheel effect increasing the already excellent starting and braking progressivity typical of d.c. brake making it particularly suitable for «light» translations.

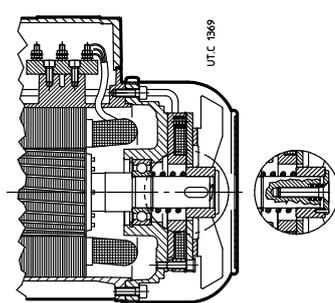

2 – Designation

2 - Designation

Designation code

R 2I 320 U P 2 D - **10,3 B3**
MR C2I 200 U O 2 V - **48 x 350** - **35,3 V5** **HB2 180L4 400-50 B5 TB3**

2

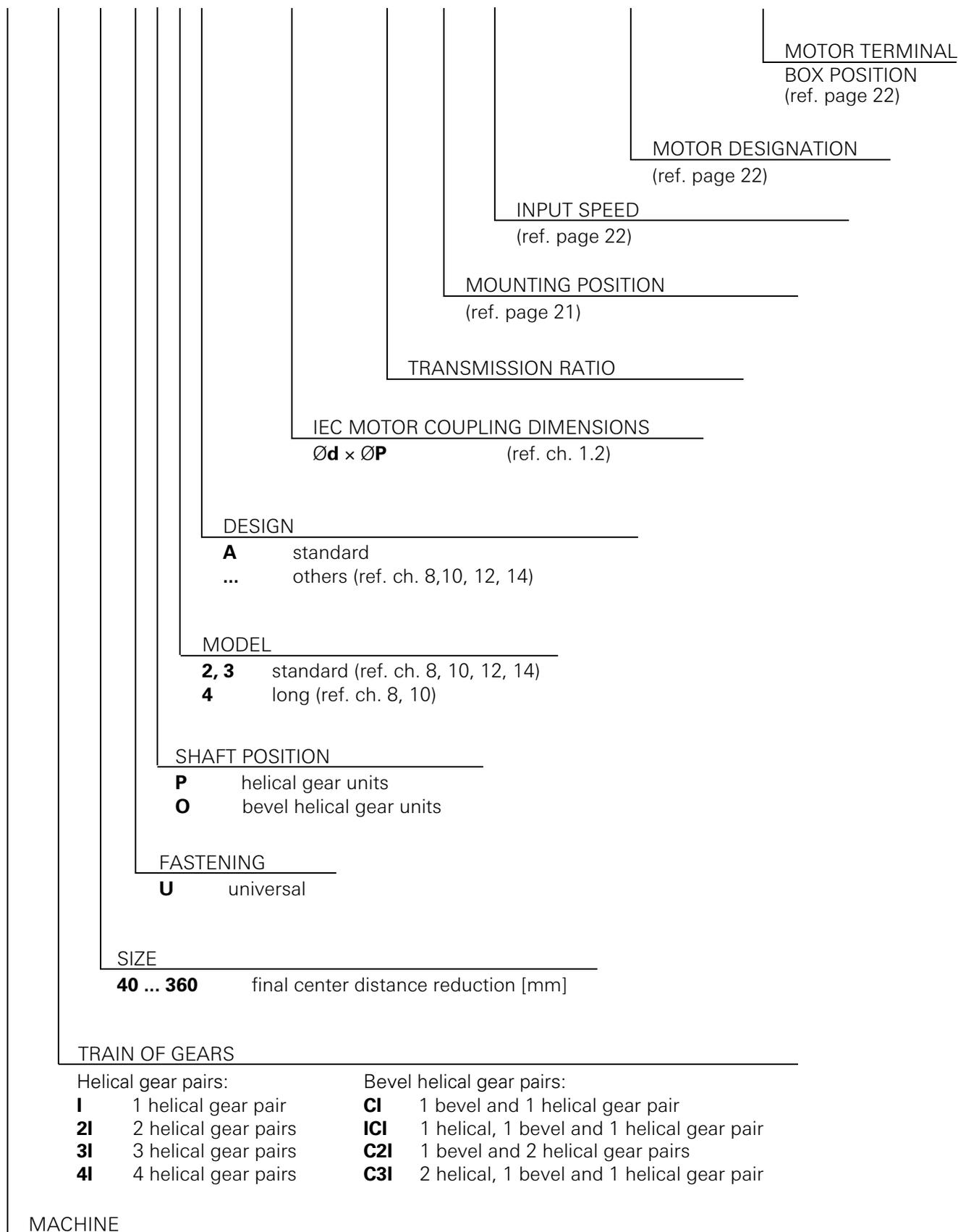

2 - Designation

Gear reducer mounting position

Gear reducer and gearmotor mounting positions are described in ch. 8, 10, 12, 14 (the mounting position designation refers to foot mounting only, even if gear reducers are for universal mounting; e.g.: B14 flange fastening and derivatives; B5 flange fastening and derivatives, see ch. 17). Here following some designation examples of important mounting positions.

1. **Standard B3** mounting position; when having no particular needs, **prefer B3 mounting position** for its technical and economic cost effectiveness (maximum simplification of lubrication system, lower oil splash, lower gear reducer heating, stock availability).

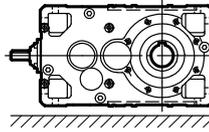

2. Non-standard mounting positions

- 2a. Mounting position as per catalog (see ch. 8, 10, 12, 14), **only one** and **fixed**, differing from B3; e.g.: mounting position **B6**

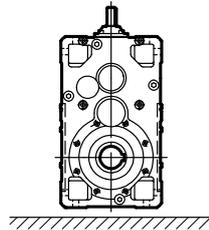

- 2b. **Inclined and fixed** mounting position; e.g.: mounting position **B6 - 20° B3**

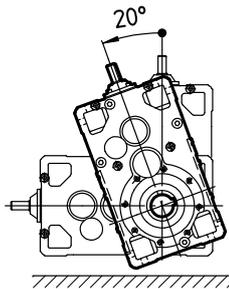

- 2c. **One only** mounting position **but defined within a pre-determined angle**; e.g.: mounting position within **B6 - 20° B3 / B6 - 65° B8**

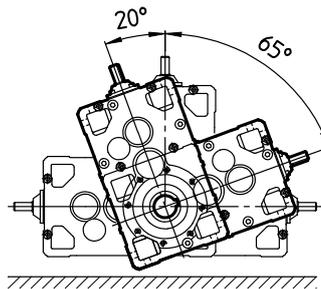

- 2d. **Oscillatory** mounting position (gear reducer oscillating when running); e.g.: mounting position **B6 - 20° B3 / B6 - 65° B8 oscillatory**

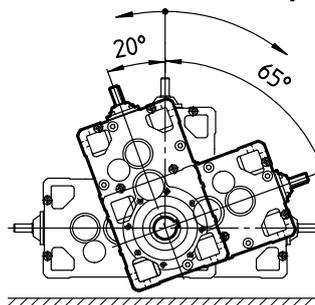

UT - C 2088

2 - Designation

Input speed

Complete the designation stating the input speed n_1 , in the following cases:

– $n_1 > 1800 \text{ min}^{-1}$ or $n_1 \leq 355 \text{ min}^{-1}$;

– for cases highlighted with following symbols (\blacktriangle , Ψ , \oplus) (ch. 7, 8, 9, 10, 12, 14);

– when forced cooling is required.

Example:

R I 125 UP2A-2,53 **mounting position V6**, $n_1 = 900 \text{ min}^{-1}$

R CI 360 UO2V-16 $n_1 = 2000 \div 600 \text{ min}^{-1}$

Motor

When the gearmotor is supplied **equipped with a standard Rossi motor**, fill in the designation stating the motor designation (ref. cat. TX).

Example:

MR ICI 200 UO3A - 48 x 350 - 50,3

HB2 160M4 400-50 B5

Where **brake motor** is required, insert the letters **HBZ** (ref. cat. TX).

Example:

MR ICI 200 UO3A - 42 x 350 - 50,3

HBZ 160L 4 400-50 B5

When the gearmotor is supplied **without motor**, omit the designation and add «without motor».

Example:

MR 2I 140 UP2A - 48 x 350 - 17,6 **without motor**

When motor is supplied by the **Buyer**¹⁾, complete the designation by stating the description of «motor supplied by us».

1) The motor supplied by the Buyer must be to IEC with mating surfaces machined under accuracy rating IEC 60072-1 and is to be sent carriage and expenses paid to our factory for fitting to the gear reducer.

Example:

MR 2I 140 UP2A - 48 x 350 - 17,6

motor supplied by us

Motor terminal box position

Complete the designation stating the motor terminal box position if differing from the standard one (TB0; see ch.12, 14 and scheme below).

The cable input is Buyer's responsibility.

Example:

MR ICI 200 UO3A - 42 x 350 / 50,3

HB2 160M4 400-50 B5 **TB3**

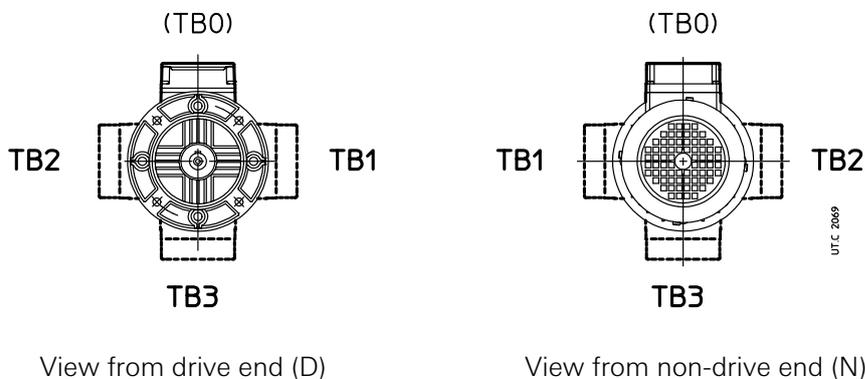

Accessories and non-standard designs

In the event of a gear reducer or gearmotor being required in a design different from those stated above, specify it in detail (ch. 17).

3 – Service factor f_s

3 - Service factor f_s

Service factor f_s takes into account the different running conditions (nature of load, running time, frequency of starting, speed n_2 , other considerations) which must be referred to when performing calculations of gear reducer selection and verification.

The powers and torques shown in the catalog are nominal (i.e. valid for $f_s = 1$) for gear reducers, corresponding to the f_s indicated for gearmotors.

The **minimum service factor required** is given by:

$$f_s \text{ required} \geq f_{s1} \cdot f_{s2} \cdot f_{s3} \cdot f_{s4} \cdot f_{s5}$$

or, in case of selection according to $n_2 \cdot L_n$:

$$f_s \text{ required} \geq f_{s1}(8 \text{ h/d}) \cdot f_{s2} \cdot f_{s3} \cdot f_{s4}$$

Service factor f_{s1} according to **nature of load** and to **running time**

Nature of load of driven machine ¹⁾		$f_{s1}^{2)}$ Running time [h/d] \leq				
Ref.	Description	2	4	8	16	24
a	Uniform	0,8 ³⁾	0,9 ³⁾	1	1,18	1,32
b	Moderate overloads (1,6 x normal)	1	1,12	1,25	1,5	1,7
c	Heavy overloads (2,5 x normal)	1,32	1,5	1,7	2	2,24

Service factor f_{s2} based on **nature of load** and of **frequency of starting**

Nature of load of driven machine ¹⁾		f_{s2} Frequency of starting z [starts/h]							
Ref.	Description	2	4	8	16	32	64	125	250
a	Uniform	1	1,06	1,12	1,18	1,25	1,32	1,4	1,5
b	Moderate overloads (1,6 x normal)	1	1	1,06	1,12	1,18	1,25	1,32	1,4
c	Heavy overloads (2,5 x normal)	1	1	1	1,06	1,12	1,18	1,25	1,32

Service factor f_{s3} based on **motor type**

Motor type	Description	f_{s3}
Electric three-phase	$P_1 \leq 9,2 \text{ kW}$	1
	$P_1 > 9,2 \text{ kW}^{4)}$	1,06 ⁴⁾
Brake electric three-phase		1,06
Internal combustion	multi-cylinder	1,25
	single-cylinder	1,5

Service factor f_{s4} based on **reliability level**

Reliability level ⁵⁾	f_{s4}
normal	1
medium	1,25
high	1,4

Service factor f_{s5} based on **output angular speed n_2**

Output speed n_2 [min ⁻¹]	f_{s5}
560 ÷ 355	1,25
355 ÷ 224	1,18
224 ÷ 140	1,12
140 ÷ 90	1,06
< 90	1

Details and considerations about service factor.

f_s values stated above are valid for:

- maximum time on overload 15 s, on starting 3 s; if over and/or subject to heavy shock effect, consult us;
- a whole number of overload cycles (or start) **imprecisely** completed in 1, 2, 3 or 4 revolutions of low speed shaft; if **precisely** a continuous overload should be assumed;

Motors having a starting torque not exceeding nominal values (star-delta starting, particular types of motor operating on direct current, and single-phase motors), and particular types of coupling between gear reducer and motor, and gear reducer and driven machine (flexible, centrifugal, fluid and safety couplings, clutches and belt drives) affect service factor favourably, allowing its reduction in certain heavy-duty applications; consult us if need be.

1) For indication on the type of load of the driven machine according to the application, see table on next page.

2) When selecting with $n_2 \cdot L_n$, use exclusively the column 8 h/d.

3) Verify that the torque M_2 is lower than or equal to M_{N2} valid for $n_1 \leq 90 \text{ min}^{-1}$ (see pages 107 and 195); when having variable load verify each load cycle interval (see ch. 5.2).

4) For Y- Δ starts, running with inverter or «soft start» devices, $f_{s3}=1$.

5) Reliability degrees higher than normal are required in presence of: very difficult maintenance, great importance of gear reducer in the production cycle, safety, etc.

3 - Service factor f_s

Classification of nature of load according to application

Application	Ref. load *	Application	Ref. load *	Application	Ref. load *
Stirrers and mixers Liquids: – constant density – varying density, solids in suspension, high viscosity concrete mixers, mullers, flash mixers	a b c	Lumber and woodworking industries mechanical loaders, pallet stackers conveyors for: – boards, chips, waste – logs machine tools (planing, cutting, cross-cut and re-sawing, tenoning, bevelling, moulding, sanding, sizing and scratch-brushing machinery etc.): – feed drive – cutter drive barkers: – mechanical and hydraulic – drum	a, b b c	transverse drive rollers, draw benches, coilers, inverter, draglines, flattening rolls, bending rolls pushers, descaling equipment, pipe welders, mill roll train drives, rolling mills, forging presses, billet croppers, power hammers, punches, impact extruders, tapping machines, straightening presses Rollerways Mills rotary (rod, roller, pebble, ball) hammer, pin crusher, centrifugal, impact, rolling (ball or roller)	b c b, c ³⁾ b c
Feeders and batchers rotary (roller, table, sector) belt, screw, plate reciprocating, shaker	a a, b c	Oil industry paraffin filter presses, chillers rotary drilling equipment pumping equipment	b b, c b c	Pumps rotary (gear, screw, lobe, vane) and axial centrifugal: – liquids, constant density – liquids, variable density or high viscosity proportioning alternative: – single acting (≥ 3 cylinders), double acting (≥ 2 cylinders) – single acting (≤ 2 cylinders), double acting single cylinder	a, b a b b b c
Compressors centrifugal (single-stage, multi-stage) rotary (vane, lobe, screw) axial reciprocating: – multi-cylinder – single-cylinder	a b b c	Textile industry calenders, cards, pickers, dryers, nappers, spinners, slashers, pads, soapers, washers, mangles, tenter frames, looms (Jacquard), warping machines, winders, knitting machines, dyeing machines, twisting frames, gig mills, cutters	b c b c	Rotating drums dryers, chillers, rotary kilns, washing machines tumblers, cement kilns	a a b b c b c
Elevators belt, centrifugal or gravity discharge, screw jacks, escalators bucket, arm and tray elevators, paddle wheel, hoists, skips man lifts, mobile scaffolding, passenger transport (cable cars, chair, ski, gondola lifts etc.)	a, b b a, b	Clay working machinery pug mills, extruders, rotary deslimers brick and tile presses	b b c	Transport conveyors belts (plastic, rubber, metal) for: – fine grade loose material – coarse grade loose material or discrete items belt, apron, bucket, slat, tray, roller, screw, chain, overhead rail, assembly drag (slat, flight, chain, Redler, etc.) ground level chain, flow accumulating reciprocating, shaker overhead power rail	b c a b b b c c ⁴⁾
Excavators and dredges cable reels, conveyors, pumps, winches (manoeuvring and utility), stackers, draining wheels cutter head drives, cutters, excavators (bucket ladder, paddle wheel, cutter) vehicles: – on rails – crawlers	b c b c	Rubber and plastics industries extruders: – plastics – rubber mixing mills, warming mills, friction calenders, refiners, tubers and strainers, rolling mills crackers, masticators	b c b c	Wrapping and stacking machinery wrapping (film, cardboard), binding, strapping and labelling equipment palletizing/depalletizing and stacking/unstacking machinery, palletizing robots	a b b c
Crushers and granulators sugar cane, rubber, plastics minerals, stone	b c	Engineering machine tools boring, shaping, planing, broaching, gear cutting and FMS machines, etc.: – main drivers (cut and feed) auxiliary drives (tools magazine, chip conveyor, workpiece infeed)	b c	Sewage treatment biological tanks (revolving disk) dewatering screws, collectors, rotary screens, thickeners, vacuum filters, anaerobic digestion tanks aerators, rotary breakers	a b b c
Cranes, winches and travelling lifts travel (bridge, trolley, forks) ¹⁾ slewing hoist ²⁾	b b a, b	Mechanisms indexing, crank and slotted link, Maltese cross, articulated parallelogram rod and crank, cam control (cam and tappet, cam and rocker)	a b b c	Screen and riddles air washing, travelling water intake rotary (stone, gravel, cereals) vibrating screens, riddles, jigs	a b b c
Food industry cookers (cereals and malt), mash tubs slicers, dough mixers, meat grinders, beet slicers, centrifuges, peelers, winemaking plant, bottle/bin/crate washers, rinsers, fillers, corkers, cappers, extruders, crate filling and emptying equipment	a b b c	Metal mills shears: – trimming, cropping, facing – for sheet/plate, ingots, billets	b c b c	Fans small diameter (centrifugal, axial-flow) large diameter (mines, furnaces, etc.) cooling towers (inducted or forced draft), ducted, piston	a b b b
Paper mills winders, suction rolls, dryers, embossing machinery, bleachers, press rolls, coating rolls, paper rolls, beaters, and pulpers agitators, mixers, extruders, chip feeders, calenders, felt dryers and stretchers, rag grinders, washers, thickeners cutters, chippers, calenders (super), felt whippers, glazing machines, presses	a b c				

* Nature of load reference admits of modification where precise knowledge of duty is available.

1) In the traverse movement of the bridge usually it is necessary to have at least $f_s > 1,6$ and in the storeyard cranes $f_s > 2$ (container handling).

2) For selection of f_s to F.E.M./I-10.1987, consult us.

3) See cat. S.

4) See supplement to cat. A.

This page is intentionally left blank.

4 – Thermal power P_t [kW]

4 - Thermal power P_t [kW]

Nominal thermal power P_{tN} , written in red in the table, is that which can be applied at the gear reducer input, also for long model, without exceeding 95 °C¹⁾ approximately oil temperature when operating in following running conditions:

- input speed $n_1 = 1\,400\text{ min}^{-1}$;
- mounting position B3;
- continuous duty S1;
- maximum ambient temperature 20 °C (in the table, values referred to 40 °C are stated as well);
- maximum altitude 1 000 m above sea level;
- air speed $\geq 1,25\text{ m/s}$ (Value typical in presence of an gearmotor with self cooled motor).

T_{amb} °C	Train of gear	Gear reducer size															
		$P_{tN}^{2)}$ kW															
		40	50	63, 64	80, 81	100	125	140	160	180	200	225	250	280	320,321	360	
20	I	-	-	15	22,4	33,5	50	67	75	106	118	170	190	265	300	425	
	2I	4,5	6,7	10	15	22,5	33,5	37,5	50	56	80	90	125	140	200	224	
	3I	3,35	5	7,5	11,2	17	25	28	37,5	42,5	60	67	95	106	150	170	
	4I	-	-	5,6	8,5	12,5	19	-	-	-	-	-	-	-	-	-	
	CI	4	6,3	9,5	14	21,2	31,5	42,5	47,5	67	75	106	118	170	190	265	
	ICI	2,8	4,25	6,3	9,5	14	21,2	23,6	31,5	35,5	50	60	67	95	106	150	
	C2I	-	-	-	-	-	-	28	37,5	42,5	60	67	95	106	150	170	
	C3I	-	3,15	4,75	7,1	10,6	16	-	-	-	-	-	-	-	-	-	
	40	I	-	-	11,2	17	25	37,5	50	56	80	90	125	140	200	224	315
		2I	3,35	5	7,5	11,2	17	25	28	37,5	42,5	60	67	95	106	150	170
3I		2,5	3,75	5,6	8,5	12,5	19	21,2	28	31,5	45	50	71	80	112	125	
4I		-	-	4,25	6,3	9,5	14	-	-	-	-	-	-	-	-	-	
CI		3	4,75	7,1	10,6	16	23,6	31,5	35,5	50	56	80	90	125	140	200	
ICI		2,12	3,15	4,75	7,1	10,6	16	18	23,6	26,5	37,5	45	50	71	80	112	
C2I		-	-	-	-	-	-	21,2	28	31,5	45	50	71	80	112	125	
C3I		-	2,36	3,55	5,3	8	11,8	-	-	-	-	-	-	-	-	-	

Always verify that power applied P_1 is lower than or equal to gear reducer nominal thermal power P_{tN} multiplied by the corrective coefficients $ft_1, ft_2, ft_3, ft_4, ft_5$ (stated in the following tables) considering the several operational conditions:

$$P_1 \leq P_{tN} \cdot ft_1 \cdot ft_2 \cdot ft_3 \cdot ft_4 \cdot ft_5$$

When the power applied is not constant and when the exact load cycle is given, it is possible, or advisable, to calculate the equivalent power applied, according to the formula:

$$P_{1th} = \frac{1}{\eta} \cdot \sqrt[3]{\frac{P_{21}^3 \cdot t_1 + P_{22}^3 \cdot t_2 + \dots + P_{2i}^3 \cdot t_i + \dots + P_{2n}^3 \cdot t_n}{t_c}}$$

where:

η is the efficiency of gear reducer (see ch. 6);

P_{2i} [kW] is the power, referred to the gear reducer output, required in the time interval t_i [s];

$t_c = t_1 + t_2 + \dots + t_i + \dots + t_n$ is the total duration of load cycle [s].

In these cases choose factor ft_2 from the continuous duty column S1.

Whenever the thermal verification should not be satisfied, in spite the prearrangement of cooling system, it is possible to install an **independent cooling unit with heat exchanger** (see ch. 17); consult us.

Thermal power needs not be taken into account when maximum duration of continuous running time is 1 ÷ 3 h (from small to large gear reducer sizes) followed by rest periods long enough to restore the gear reducer to near ambient temperature (likewise 1 ÷ 3 h).

In case of maximum ambient temperature above 50 °C or below 0 °C consult us.

Thermal factor ft_1 (= $ft_{1a} \cdot ft_{1b}$) according to **cooling system** and **input speed n_1**

Cooling system			ft_{1a}, ft_{1b}				
			input speed n_1 [min ⁻¹] \geq				
			710	900	1 120	1 400	1 800
ft_{1a}	Natural convection	train of gears	1	1,18	1,12	1	0,71
		2I, CI	1,18	1,12	1,06	1	0,85
		3I, 4I, ICI, C2I, C3I	1,06	1,06	1,03	1	0,95
ft_{1b}	Fan cooling ^{3) 4) 6)}	with 1 radial fan (helical gear unit)	1,12	1,18	1,25	1,32	1,4
		with 2 radial fans (helical gear unit) with 1 radial fan (bevel helical gear unit)	1,25	1,4	1,6	1,8 ⁵⁾	2
	with water coil ⁴⁾	2					
	with internal exchanger ⁴⁾	see ch. 17					

1) Corresponding to a mean temperature of the housing external surface approx. equal to 85°C (locally this temperature may also reach the oil one).

2) For bevel helical gear reducers and gearmotors with double extension high speed shaft multiply P_{tN} by **0,85**.

3) With simultaneous water cooling by coil, values are multiplied by 1,8.

4) Refer to ch. 17 about positions, overall dimensions and design verification.

5) Value valid also for proper electric fan (installation by Customer).

6) With axial fan, the values are to be multiplied by 1,12. Consult us.

4 - Thermal power P_t [kW]

Thermal factor ft_2 according to **ambient temperature** and **service**

Maximum ambient temperature °C	ft_2				
	Continuous duty	Intermittent duty S3 ... S6			
		Cyclic duration factor [%] for 60 min running ¹⁾			
	S1	60	40	25	15
50	0,6	0,71	0,8	0,95	1
40	0,75	0,9	1	1,12	1,25
30	0,9	1,06	1,18	1,32	1,5
20	1	1,18	1,32	1,5	1,7
10	1,12	1,32	1,5	1,7	1,9

Thermal factor ft_4 according to **installation altitude**

Altitude a.s.l. m	ft_4
$\leq 1\ 000$	1
1 000 ÷ 2 000	0,95
2 000 ÷ 3 000	0,9
3 000 ÷ 4 000	0,85
> 4 000	0,8

Thermal factor ft_3 according to **mounting position** (see also ch. 8, 10, 12, 14); **where it is not specified $ft_3 = 1$**

Train of gears	Mounting position	ft_3								
		140	160	180	200	225	250	280	320, 321	360
R I	B6	1	0,71	0,71	0,71	0,71	0,71	0,71	0,71	0,71
	B7	0,85	0,85	0,85	0,85	0,85	0,85	0,85	0,85	0,85
	B8	0,85	1	0,85	1	0,85	1	0,85	1	0,85
R 2I MR 2I	B6 $i_N \leq 14$ $i_N \geq 16$	1 1	1 1	1 1	0,85 1	0,85 1	0,85 1	0,85 1	0,85 0,85	0,85 0,85
	B7 $i_N \leq 14$ $i_N \geq 16$	1 1	0,71 1	0,71 1	0,71 1	0,71 1	0,71 0,71	0,71 0,71	0,71 0,71	0,71 0,71
	V5 $i_N \leq 14$ $i_N \geq 16$	1 1	1 1	1 1	0,71 1	0,71 1	0,71 1	0,71 1	0,71 0,71	0,71 0,71
	V6 $i_N \leq 14$	1	1	1	1	1	1	1	0,85 ²⁾	0,85 ²⁾
R 3I MR 3I	B6 $i_N \leq 63$	1	1	1	1	1	0,85	0,85	0,85	0,85
	B7 $i_N \leq 63$ $i_N \geq 71$	1 1	1 1	1 1	0,71 1	0,71 1	0,71 1	0,71 1	0,71 0,71	0,71 0,71
	V5 $i_N \leq 63$	1	1	1	1	1	1	1	0,71	0,71
	V6 $i_N \leq 63$	1	1	1	1	1	0,85	0,85	0,85	0,85
R CI	B6 $i_N \leq 8$	1	1	1	1	1	0,85	0,85	0,85	0,85
	B7	1	0,71	0,71	0,71	0,71	0,71	0,71	0,71	0,71
	B8	0,85	1	0,85	1	0,85	1	0,85	1	0,85
	V5, V6 ● below $i_N \leq 11,2$ ● above	1 1	1 0,71	1 0,71	1 0,71	1 0,71	1 0,71	0,85 0,71	0,85 0,71	0,85 0,71
MR CI	B7	1	1	1	1	1	0,85	0,85	–	–
	B8	0,85	1	0,85	1	0,85	1	0,85	–	–
	V5, V6 ● above	1	1	1	1	1	0,85	0,85	–	–
R C2I	B6 $i_N \leq 28$	1	1	1	1	1	1	1	0,85	0,85
	B7	1	1	1	0,71	0,71	0,71	0,71	0,71	0,71
	V5, V6 ● below ● above	1 1	1 1	1 1	0,71 1	0,71 1	0,71 1	0,71 1	0,71 0,85	0,71 0,85
MR C2I	B7	1	1	1	1	1	1	1	0,85	0,85

Thermal factor ft_5 as dependent on air speed on the housing

Air speed m/s	Working environment	ft_5
< 0,63	very small no air movement gear reducer shielded	Consult us
0,63	small and with limited air movement	0,71
1	large and without ventilation	0,90
1,25	large and with slight ventilation (e.g. gearmotor with self-cooled motor)	1,00
2,5	outdoor ventilated	1,18
4	strong air movement	1,32

1) (Duration of running on load [min] / 60) · 100 [%].

2) For MR 2I, $ft_3 = 1$.

● Position of reference groove (see ch. 6).

4 - Thermal power P_t [kW]



Fan cooling for helical and bevel helical gear reducers, respectively.

With double extension high speed shaft designs, (... **D**, ... **H** and ... **R**) both extensions are **accessible** even with fan fitted: **personal safety-guards are the Buyer's responsibility (2006/42/EC).**

5 – Selection

5 - Selection

5.1 - Preliminary considerations

Motor power

Taking into account the efficiency of the gear reducer, and other drives – if any – motor power is to be as near as possible to the power rating required by the driven machine: accurate calculation is therefore recommended.

The power required by the machine can be calculated, seeing that it is related directly to the power-requirement of the work to be carried out, to friction (starting, sliding or rolling friction) and inertia (particularly when mass and/or acceleration or deceleration are considerable). It can also be determined experimentally on the basis of tests, comparisons with existing applications, or readings taken with amperometers or wattmeters.

An oversized motor would involve: a greater starting current and consequently larger fuses and heavier cable; a higher running cost as power factor ($\cos \varphi$) and efficiency would suffer; greater stress on the drive, causing danger of mechanical failure, drive being normally proportionate to the power rating required by the machine, not to motor power.

In such cases, a detailed description of duty requirement must be made available: duration and frequency per hour of work cycle, acceleration and deceleration requirements if any, inertia, loads deriving from friction and work. In the absence of such data it is essential to provide all details which will permit their determination.

Only high values of ambient temperature, altitude, frequency of starting or other particular conditions require an increase in motor power.

Input speed n_1

For gear reducers, the maximum input speed, valid for **continuous duty S1**, is the one stated in the following table, according to train of gears and to gear reducer size; however, depending on the specific transmission ratio this limit may not be reachable: for these cases, in the selection tables (see ch. 7, 9), the nominal power P_{N2} isn't stated and the given M_{N2} value is valid for the selection method type B (see ch. 5.2) only.

For intermittent duty or for particular needs, higher speeds may be possible, but always lower than values of n_{1peak} : consult us.

Peak speed is admitted for a maximum duration of 5s, including a proper rest period or a low speed period for the cooling of gear reducer, especially on high speed shaft side.

For variable n_1 , the selection should be carried out on the basis of n_{1max} , but it should also be verified on the basis of n_{1min} .

When there is a belt drive between motor and gear reducer, different input speeds n_1 should be examined in order to select the most suitable unit from engineering and economy standpoints alike (our catalog favours this method of selection as it shows a number of input speed values n_1 relating to a determined output speed n_{N2} in the same section).

Input speed should not be higher than $1\,800\text{ min}^{-1}$, unless conditions make it necessary; better to take advantage of the transmission, and use an input speed lower than 900 min^{-1} .

Gear reducer size	Train of gear											
	I		2I		3I		CI		ICI		C2I	
	n_{1max} min^{-1}	n_{1peak} min^{-1}	n_{1max} min^{-1}	n_{1peak} min^{-1}	n_{1max} min^{-1}	n_{1peak} min^{-1}	n_{1max} min^{-1}	n_{1peak} min^{-1}	n_{1max} min^{-1}	n_{1peak} min^{-1}	n_{1max} min^{-1}	n_{1peak} min^{-1}
50	–	–	2 800	3 500	–	–	2 800	3 500	2 800	3 500	–	–
63, 64	2 800	3 500	2 800	3 500	2 800	3 500	2 800	3 500	2 800	3 500	–	–
80, 81	2 800	3 500	2 800	3 500	2 800	3 500	2 800	3 500	2 800	3 500	–	–
100	2 800	3 500	2 800	3 500	2 800	3 500	2 800	3 500	2 800	3 500	–	–
125	2 800	3 500	2 800	3 500	2 800	3 500	2 800	3 500	2 800	3 500	–	–
140	2 800	3 500	2 800	3 500	2 800	3 500	2 800	3 500	2 800	3 500	2 800	3 500
160	2 800	3 500	2 800	3 500	2 800	3 500	2 800	3 500	2 800	3 500	2 800	3 500
180	2 800	3 500	2 800	3 500	2 800	3 500	2 800	3 500	2 800	3 500	2 800	3 500
200	2 800	3 500	2 800	3 500	2 800	3 500	2 800	3 500	2 800	3 500	2 800	3 500
225	2 500	3 500	2 800	3 500	2 800	3 500	2 800	3 500	–	–	2 800	3 500
250	2 000	2 360	2 800	3 500	2 800	3 500	2 360	3 350	–	–	2 800	3 500
280	2 000	2 360	2 800	3 500	2 800	3 500	2 360	3 350	–	–	2 800	3 500
320, 321	1 800	2 360	2 000	2 360	2 800	3 500	2 000	2 800	–	–	2 360	3 500
360	1 800	2 360	2 000	2 360	2 800	3 500	2 000	2 800	–	–	2 360	3 500

5.2 - Gear reducer

For the determination of gear reducer size it is possible to proceed in two different ways:

A) considering **the daily running time (h/d)**;

B) considering the **total running duration** request L_h

Method A) is easier but more generic and requires a good knowledge of the applications; on the contrary, method B) is more accurate, but more complex.

Attention: Concerning above mentioned points, the gear reducer nominal performance calculated in the two different ways could slightly differ; in these cases, however, method B), as it is more precise, will be considered valid.

5 - Selection

Method A - Determining the gear reducer size considering the daily running time (h/d)

- Fill in the selection questionnaire in all its parts at page 36; in particular, make available the power P_2 required at gear reducer output, the angular speeds n_2 and n_1 , the running conditions (nature of load, daily running time **h/d**, frequency of starting z , other considerations) referring to ch. 3.
- Determine service factor f_s on the basis of running conditions (ch. 3).
- Select the gear reducer size (also, the train of gears and transmission ratio i at the same time) on the basis of n_2 , n_1 and of a power P_{N2} greater than or equal to $P_2 \cdot f_s$ (ch. 7 and 9).
- Calculate power P_1 required at input side of gear reducer using the formula P_2 / η where $\eta = 0,98 \div 0,92$ is the efficiency of the gear reducer (ch. 6).

When for reasons of motor standardization, power P_1 applied at input side of gear reducer turns out to be higher than the power required (considering motor/gear reducer efficiency), it must be certain that this excess power applied will never be required, and frequency of starting z is so low as not to affect service factor (ch. 3).

Otherwise, make the selection by multiplying P_{N2} by P_1 applied / P_1 required.

Calculations can also be made on the basis of torque instead of power; this method is even preferable for low n_2 values.

Method B - Determining the gear reducer size considering the total running duration L_h

- Fill in the selection questionnaire in all its parts at page 36; in particular, make available the torque M_2 , the angular speed n_2 required at gear reducer output, the running conditions (nature of load, **total running duration** foreseen L_h , frequency of starting z , other considerations) referring to ch. 3.
- In presence of required torque M_2 and angular speed n_2 **variable in time**, according to a given load cycle, calculate the equivalent torque M_{2eq} and the equivalent angular speed n_{2eq} with the following formulae:

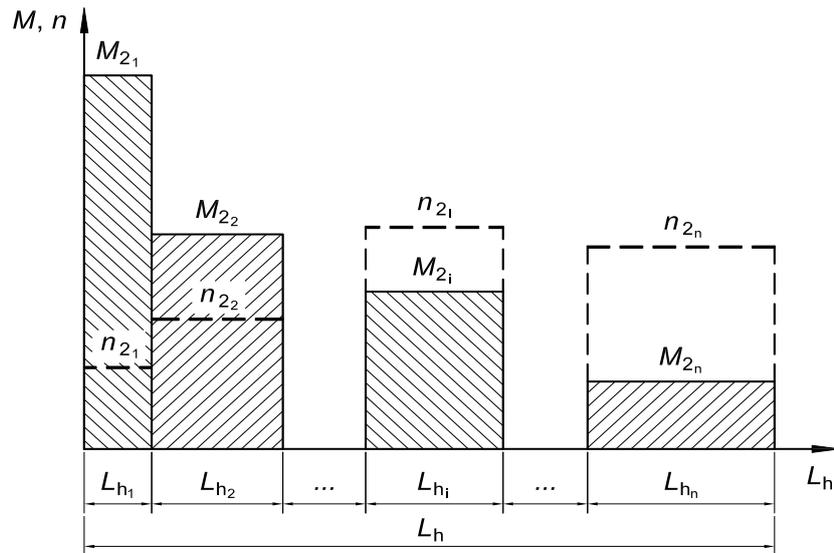

$$M_{2eq} = \sqrt[p]{\frac{M_{21}^p \cdot n_{21} \cdot L_{h1} + M_{22}^p \cdot n_{22} \cdot L_{h2} + \dots + M_{2i}^p \cdot n_{2i} \cdot L_{hi} + \dots + M_{2n}^p \cdot n_{2n} \cdot L_{hn}}{n_{2eq} \cdot L_h}}$$

$$n_{2eq} = \frac{n_{21} \cdot L_{h1} + n_{22} \cdot L_{h2} + \dots + n_{2i} \cdot L_{hi} + \dots + n_{2n} \cdot L_{hn}}{L_h}$$

where:

- M_{2eq} [N m] is the load cycle equivalent torque
- M_{2i} [N m] is the required torque (constant) on the low speed shaft during interval i
- n_{2eq} [min^{-1}] is the load cycle equivalent speed
- n_{2i} [min^{-1}] is the speed (constant) of the low speed shaft in the interval i
- L_{hi} [h] is the duration of interval i
- L_h [h] $L_{h1} + \dots + L_{hi} + \dots + L_{hn}$ is the total duration of load cycle
- $p = 3,33$ if $n_{2eq} \cdot L_h >$ value stated in the following table according to the train of gears
- $p = 6,61$ if $n_{2eq} \cdot L_h \leq$ value stated in the following table according to the train of gears

5 - Selection

$n_{2eq} \cdot L_h$ [min ⁻¹ · h]					
R I	R 2I	R 3I	R CI	R ICI	R C2I
2 000 000	2 800 000	4 000 000	1 400 000	2 000 000	710 000

- Determine service factor fs required (fs required $\geq fs_1 \cdot fs_2 \cdot fs_3 \cdot fs_4$) on the basis of running conditions (ch. 3) choosing fs_1 , according to nature of load, **exclusively** inside the **column** relevant to **duration 8 h/d**.
- Calculate the life factor $n_2 \cdot L_h$ (or $n_{2eq} \cdot L_h$).
- Calculate the transmission ratio i required according to n_1 and n_2 (or n_{2eq}).
- Select the gear reducer size (also, the train of gears and transmission ratio i at the same time) on the basis of $n_{N2} \cdot L_h$, i_N close to the values previously calculated and on the basis of a torque M_{N2} greater than or equal to $M_2 \cdot fs$ required (or $M_{2eq} \cdot fs$ required), see ch. 7 and 9.
- Calculate power P_1 required at input side of gear reducer using the formula P_2 / η where $\eta = 0,98 \div 0,92$ is the efficiency of the gear reducer (ch. 6).

When for reasons of motor standardization, power P_1 applied at input side of gear reducer turns out to be higher than the power required (considering motor/gear reducer efficiency), it must be certain that this excess power applied will never be required, and frequency of starting z is so low as not to affect service factor (ch. 3).

Otherwise, make the selection by multiplying P_{N2} by P_1 applied P_1 required.

Attention. The values of P_{N2} highlighted in the selection tables with grey background are valid only for the value of n_{N2} specified and therefore they are to be ignored for whatever value of $n_2 \cdot L_h$.

Verifications

- Verify possible radial loads F_{r1} , F_{r2} and axial load F_{a2} by referring to instructions and values given in ch. 16.
- When a load chart is available, and/or there are overloads – due to starting on full load (especially with high inertias and low transmission ratios), braking, shocks, gear reducers in which the low speed shaft becomes driving member due to driven machine inertia, or other static or dynamic causes - verify that the maximum torque peak (ch. 6) is always less than **$1,6 \cdot M_{N2}$** ; if it is higher or cannot be evaluated in the above cases, install a safety device so that **$1,6 \cdot M_{N2}$ will never be exceeded**.
- Verify, when $fs < 1$, that torque M_2 is less than or equal to M_{N2} value valid for $n_1 \leq 90$ min⁻¹ (see pages 107 and 195),
- Verify that input speed is lower than or equal to n_{1max} (see ch. 5.1);
- Verify **for each single interval i** of the eventual load cycle that the torque required M_{2i} is lower than **$1,6 \cdot M_{N2}$** and anyway never higher than M_{N2} valid for $n_1 \leq 90$ min⁻¹ (see page 107 and 195) and that the input speed (relevant to the low speed shaft speed n_{2i}) is $n_{1i} \leq n_{1max}$ (see ch. 5.1);
- Verify, usually for sizes ≥ 100 , possible need for forced cooling (ch. 4 and 17).
- For gear reducers sizes 140, 180, 225, 280, 321, 360 with backstop device having particular i_N or low fs values, verify load capacity of backstop device according to the values given in the table «Backstop device load capacity» (ch. 17).

5.3 - Gearmotor

Determining the gearmotors size

- Fill in the selection questionnaire in all its parts at page 36; in particular, make available the necessary data: power P_2 required at gearmotor output, angular speed n_2 , running conditions (nature of load, duration, frequency of starting z , other considerations), referring to ch. 3.
- Determine service factor fs on the basis of running conditions (ch. 3).
- Select the gearmotor size on the basis of n_2 , fs and of a power P_1 greater than or equal P_2 (ch. 11, 13). If power P_2 required is the result of a precise calculation, the gearmotor should be selected on the basis of a power P_1 equal to or greater than P_2 / η , where $\eta = 0,96 \div 0,92$ is gear reducer efficiency (ch. 6). The torque value M_2 stated in the tables (ch. 11, 13) has been calculated taking into account efficiency.

When for reasons of motor standardization, power P_1 available in catalog is much greater than the power P_2 required, the gearmotor can be selected on the basis of a lower service factor ($fs \cdot P_2 / P_1$) provided it is certain that this excess power available will never be required and frequency of starting z is low enough not to affect service factor (ch. 3).

Calculations can also be made on the basis of torque instead of power; this method is even preferable for low n_2 values.

5 - Selection

Verifications

- Verify possible radial load F_{r2} and axial load F_{a2} referring to directions and values given in ch. 16.
- For the motor, verify frequency of starting z when higher than that normally permissible, referring to directions and values given in ch. 1.2; this will normally be required for brake motors only.
- When a load chart is available, and/or there are overloads – due to starting on full load (especially with high inertias and low transmission ratios), braking, shocks, gear reducers in which the low speed shaft becomes driving member due to driven machine inertia, or other static or dynamic causes - verify that the maximum torque peak (ch. 6 is always less than $1,6 \cdot M_{N2}$ ($M_{N2} = M_2 \cdot fs$, see ch. 11 and 13); if it is higher or cannot be evaluated in the above cases, install a safety device so that **$1,6 \cdot M_{N2}$ will never be exceeded.**
- Verify, usually for $P_1 \geq 30$ kW, possible need for forced cooling (ch. 4 and 17).

5.4 - Questionnaire for the selection

For the collection of data and of all information necessary for a correct selection of gear reducer or gearmotor, fill in the questionnaire at the following page.

Attach technical specifications, if any, concerning the gear reducer or the gearmotor excluding other parts of the machine or of the plant.

When it is possible, attach the questionnaire with drawings, pictures and any further information useful to facilitate the best selection from a technical and economic point of view.

5 - Selection

1 Conditions of application

Area of application/Industry sector

Type of machine to be driven

- new machine
- existing and running machine gear reducer in use

Ambient temperature [°C]

min normal max

Altitude [m a.s.l.]

Ambient:

- normal (industrial) indoor
- normal (industrial) outdoor
- dusty
- corrosive / humid

Gear reducer position:

- tight space with insufficient air recycle ($v_{air} < 0,63$ m/s)
- wide space with free air recycle ($v_{air} \geq 1,25$ m/s)
- outdoor, protected against extremes of weather and radiation

2 Data of load

Output speed required [min⁻¹]

min nominal max

Output torque required [N m]

min nominal max

Power required on low speed shaft [kW]

min nominal max

Input speed (gear reducers) [min⁻¹]

min nominal max

Nature of load:

- uniform
- moderate overloads
- heavy overloads

Frequency of starting [starts/h]

Moment of inertia of machine [kg m²]

min normal max

Running time [h/d]

Total duration [h]

Duty cycle (S1 ... S10)

Load cycle attached

- yes
- no

3 Motor

Motor type:

- asynchronous three-phase (a.c.)
- asynchronous three-phase + inverter
- d.c. + converter
- internal combust. (one - cylinder)
- internal combust. (multi-cylinder)

Power P_1 [kW]

min nominal max

Nominal speed n_1 [min⁻¹]

min nominal max

A.c. motor supply:

voltage [V] frequency [Hz]

IEC motor size (a.c. motor)

A.c. motor connection:

- direct
- Y / Δ
- soft starter / inverter

Electromagnetic brake

- parking
- working
- safety

Braking torque [N m]

Starting torque [N m]

Moment of inertia [kg m²]

Electric motor design (a.c. and d.c.):

- with fan cooling
- with encoder
- with tachometer generator

Connection with gear reducer:

- with coupling
- with V-belt

section No. d_m [mm] d_1 [mm]

- with toothed belt

section No. d_m [mm]

Eventual limitation of drive overall dimensions

4 Gear reducer

Mounting position

Output shaft direction of rotation

- white arrow
- black arrow
- black and white arrow

Backstop device (if any)

- white arrow free rotation
- black arrow free rotation

Type of cooling admitted

- fan cooling
- coil
- internal heat exchanger
- unit UR O/A
- unit UR O/W

Type of connection to machine

- shaft mounting
- flexible / semi-flexible coupling
- universal coupling
- timing belt

pitch d_m d_1 φ

- chain

pitch No. z_2 z_3 overhang [mm] φ

- straight tooth helical gear pair

pitch No. z_2 z_3 overhang [mm] φ

Eventual axial load F_a [N]

Eventual reduction of drive overall dimensions

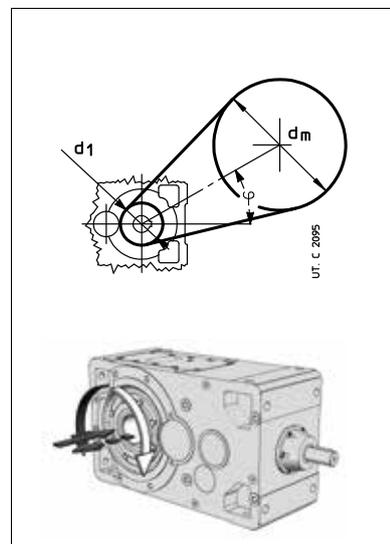

6 – Structural and operational details

Sound levels L_{WA} and L_{pA}	38
Gear ratio of input helical train of gears	38
Efficiency	38
Overload	39
Operation with brake motor	39
Angular backlash and torsional stiffness	40
Moment of inertia (of mass) J_1 [kg m ²]	40
Gear reducer input face.....	41
High and low speed shaft end	42
Reference groove	43
Plug dimensions	43
Filler and level plugs.....	43
Expansion tank (sizes 100 ... 360)	43
Cap overall dimension (sizes 63, 64, 125 and 140)	43
Reaction recess (2l, 3l, 4l sizes 40 ... 125)	44
Fastening tapped holes (sizes 125 ... 321)	44
Low speed shaft zone (sizes 140, 180, 225, 280, 360).....	44
Directions of rotation.....	45
Bearing and/or gear pair forced lubrication: hydraulic circuit diagram.....	46
Bearing and/or gear pair forced lubrication with oil/air or oil/water independent cooling unit: hydraulic circuit diagram	47
Maximum bending moment of flange MR.....	48

6 - Structural and operational details

Sound levels L_{WA} and \bar{L}_{pA}

Standard production sound power level L_{WA} [dB(A)]¹⁾ and mean sound pressure level \bar{L}_{pA} [dB(A)]²⁾ assuming nominal load, and input speed $n_1 = 1\ 400^{(3)}$ min⁻¹. Tolerance +3 dB(A).

Gear reducer size	I		2I		3I, 4I		CI		ICI, C2I, C3I							
	$i_N \leq 3,55$	$i_N \geq 4$	$i_N \leq 14$	$i_N \geq 16$	$i_N \leq 90$	$i_N \geq 100$	$i_N \leq 18$	$i_N \geq 20$	$i_N \leq 80$ (ICI)	$i_N \leq 71$ (C2I)	$i_N \geq 100$ (ICI, C3I)	$i_N \geq 80$ (C2I)				
	L_{WA}	\bar{L}_{pA}	L_{WA}	\bar{L}_{pA}	L_{WA}	\bar{L}_{pA}	L_{WA}	\bar{L}_{pA}	L_{WA}	\bar{L}_{pA}	L_{WA}	\bar{L}_{pA}				
40, 50	-	-	-	-	75	66	72	63	71	64	-	-	73	64	71	62
63, 64	83	74	79	70	78	69	75	66	74	64	72	62	76	67	73	64
80, 81	86	77	82	73	81	72	78	69	77	67	75	65	79	70	75	66
100	89	80	85	76	84	75	81	72	80	70	78	68	82	73	78	69
125, 140	92	83	88	79	87	77	84	74	83	73	80	70	85	76	80	71
160, 180	95	86	91	82	90	79	87	76	86	75	83	72	88	79	83	74
200, 225	99⁴⁾	89⁴⁾	95⁴⁾	85⁴⁾	93	82	90	79	89	78	86	75	92	82	87	77
250, 280	102⁴⁾	92⁴⁾	98⁴⁾	88⁴⁾	96	85	93	82	92	81	89	78	94	84	89	79
320 ... 360	106⁴⁾	96⁴⁾	102⁴⁾	92⁴⁾	100	89	97	86	96	85	93	82	98	88	93	83

1) To ISO/CD 8579.

2) Mean value of measurement at 1 m from external profile of gear reducer standing in free field on a reflecting surface.

3) For $n_1 = 710 \div 1\ 800$ min⁻¹, modify tabulated values: thus $n_1 = 710$ min⁻¹, -3 dB(A); $n_1 = 900$ min⁻¹, -2 dB(A); $n_1 = 1\ 120$ min⁻¹, -1 dB(A); $n_1 = 1\ 800$ min⁻¹, +2 dB(A).

4) For sizes R I 225, 280 and 360, increase values of 1 dB(A).

In case of gearmotor (motor supplied by Rossi) add 1 dB(A) to the values in the table for 4 poles 50 Hz motors, and add 2 dB(A) for 4 poles 60 Hz motors.

If required, gear reducers can be supplied with reduced sound levels (normally 3 dB(A) less than tabulated values): consult us.

In case of gear reducers with fan cooling, add to the values in the table 3 dB(A) for 1 fan and 5 dB(A) for 2 fans.

Gear ratio of input helical train of gears

The partial transmission ratio of input helical train of gears is given in the table; this ratio may be useful when calculating the speed of the intermediate shaft extension for ... **D** design (see ch. 8, 10, 12, 14).

Gear reducer size	Gear ratio of input helical train of gears									
	Gear reducer		Gearmotors							200, 225
	$i_N \leq 80$	$i_N \geq 100$	63, 71B5R	71, 80 B5R	80, 90 B5R	90, 100 B5R, 112 B5R	100, 112, 132 B5R	132, 160 B5R	160, 180, 200 B5R	
3I 40			2,41	-	-	-	-	-	-	-
3I 50			2,59	1,89	-	-	-	-	-	-
3I 63, 64	3,12		3,5	2,54	2,03	-	-	-	-	-
ICI 40, 50										
4I 63, 64			10,9	7,91	-	-	-	-	-	-
C3I 40,50										
3I, ICI 80, 81	3,18		-	3,18 (3,8) ¹⁾	2,54	2	-	-	-	-
ICI 63, 64										
4I, C3I 80, 81			-	10,1 (12,1) ¹⁾	8,08	-	-	-	-	-
C3I 63, 64										
3I, ICI 100	3,18	6,38	-	-	3,18 (3,8) ¹⁾	2,54	2	-	-	-
4I, C3I 100	-	-	-	-	10,1 (12,1) ¹⁾	8,08	-	-	-	-
3I, ICI 125	3,13	6,36	-	-	-	3,13 (3,86) ¹⁾	2,54 (3,13) ²⁾	2,03	-	-
ICI 140										
4I, C3I 125	-	-	-	-	-	9,77 (12,1) ¹⁾	7,92	-	-	-
ICI 160, 180	3,17	6,38	-	-	-	-	3,17 (4) ¹⁾	2,56	2 (2,56) ³⁾	-
ICI 200	3,17	6,38	-	-	-	-	-	3,17 (3,8) ¹⁾	2,56 (3,17) ²⁾	2 (2,56) ³⁾

1) Values valid for trains of gears: **3I** with $i_N \geq 100$, **ICI** with $i_N \geq 100$, **4I** with $i_N \geq 315$, **C3I** with $i_N = 400$.

2) Values valid for trains of gears: **3I** with $i_N = 80$, **ICI** with $i_N \geq 80$.

3) Values valid for train of gears: **ICI** with $i_N \geq 63$.

Efficiency

The efficiency stated in the table is indicative and referred to nominal running conditions (torque, speed, temperature); it is necessary to keep in mind that the efficiency value can diminish considerably for values of $M_2 \ll M_{N2}$

Model	Nominal efficiency η			
	I	2I, CI	3I, ICI, C2I	C3I, 4I
2, 3	0,98	0,96	0,94	0,92
4	-	0,95	0,935	-

6 - Structural and operational details

Overloads

When a gear reducer is subjected to high static and dynamic overloads, the need arises for verifying that such overloads will always remain lower than $1,6 \cdot M_{N2}$ (see ch. 7, 9; see ch. 11, 13 where $M_{N2} = M_2 \cdot fs$). Overloads are normally generated when one has:

- starting on full load (especially for high inertias and low transmission ratios), braking, shocks;
- gear reducers in which the low speed shaft becomes driving member due to driven machine inertia;
- applied power higher than that required; other static or dynamic causes.

The following general observations on overloads are accompanied by some formulae for carrying out evaluations in certain typical instances.

Where no evaluation is possible, install safety devices which will keep values within $1,6 \cdot M_{N2}$.

Starting torque

When starting on full load (especially for high inertias and low transmission ratios) verify that $1,6 \cdot M_{N2}$ is equal to or greater than starting torque, by using the following formula:

$$M_2 \text{ start} = \left(\frac{M_{\text{start}}}{M_N} \cdot M_2 \text{ available} - M_2 \text{ required} \right) \frac{J}{J+J_0} + M_2 \text{ required}$$

where:

M_2 required is the torque absorbed by the machine through work and frictions;

M_2 available is the output torque due to motor nominal power;

J_0 is the moment of inertia (of mass) of the motor;

J is the external moment of inertia (of mass) in kg m^2 (gear reducers, couplings, driven machine) referred to the motor shaft;

NOTE: when seeking to verify that starting torque is sufficiently high for starting, take into account starting friction, if any, in evaluating M_2 required.

Stopping machines with high kinetic energy (high moments of inertia combined with high speeds) with brake motor

Verify braking stress by means of the formula:

$$\left(\frac{Mf}{\eta} \cdot i + M_2 \text{ required} \right) \frac{J}{J+J_0} - M_2 \text{ required} < 1,6 \cdot M_{N2}$$

where:

Mf is the braking torque setting (see table in ch. 1.2); for other symbols see above and ch. 1.

Operation with brake motor

Starting time t_a and revolutions of motor φa_1

$$t_a = \frac{(J_0 + J) \cdot n_1}{9,55 \left(M_{\text{start}} - \frac{M_2 \text{ required}}{i} \right)} \quad [\text{s}]; \quad \varphi a_1 = \frac{t_a \cdot n_1}{19,1} \quad [\text{rad}]$$

Braking time t_f and revolutions of motor φf_1

$$t_f = \frac{(J_0 + J) \cdot n_1}{9,55 \left(Mf + \frac{M_2 \text{ required}}{i} \right)} \quad [\text{s}]; \quad \varphi f_1 = \frac{t_f \cdot n_1}{19,1} \quad [\text{rad}]$$

where:

M_{start} [N m] is motor starting torque $\left(\frac{9550 \cdot P_1}{n_1} \cdot \frac{M_{\text{start}}}{M_N} \right)$ (see ch. 1.2);

Mf [N m] is the braking torque setting of the motor (see ch. 1.2);

for other symbols see above and ch. 1.

Assuming a regular air-gap and ambient humidity, and utilizing suitable electrical equipment, repetition of the braking action, as affected by variation in temperature of the brake and by the state of wear of friction surface, is approx $\pm 0,1 \cdot \varphi f_1$.

Friction surface life

As a rough guide (see specific literature), the number of braking permissible between

successive adjustments of the air-gap is given by the formula $\frac{W \cdot 10^5}{Mf \cdot \varphi f_1}$

where:

W [MJ] is the work of friction between successive adjustments of the airgap as indicated in the table; for other symbols see above.

The air-gap should measure between 0,25 minimum and 0,6 maximum; as a rough guide, 5 adjustments can be made.

Motor size	W [MJ]
63	10,6
71	14
80	18
90	24
100	24
112	45
132	67
160, 180M	90
180L, 200	125

6 - Structural and operational details

Angular backlash and torsional stiffness

A rough guide for the angular backlash (high speed shaft being locked) is given in the table. It varies according to temperature and transmission ratio.

Also the **approx.** values for low speed shaft torsional stiffness – high speed shaft being locked – are given in the table according to the train of gears.

The values stated in the table, since necessarily estimated, are to be considered valid for long model too. On request, gear reducers with **reduced backlash** lower than or equal to the minimum table values are available.

Gear reducer size	Angular backlash ¹⁾				Torsional stiffness ²⁾			
	[rad]		[arcmin]		[N m / arcmin]			
	min	max	min	max	I	2I, CI	3I, ICI, C2I	4I, C3I
40	0,0043	0,0085	15	29	–	4,8	2,4	–
50	0,0036	0,0071	12	24	–	8,5	4,8	2,8
63	0,0028	0,0056	9,6	19	31,5	18	10	5,6
64	0,0028	0,0056	9,6	19	35,5	19	10,6	5,6
80	0,0025	0,0050	8,6	17	63	35,5	20	11,2
81	0,0025	0,0050	8,6	17	71	37,5	21,2	11,2
100	0,0020	0,0040	6,9	14	125	70	40	22,4
125	0,0017	0,0034	5,8	12	250	140	80	45
140	0,0017	0,0034	5,8	12	355	200	112	–
160	0,0016	0,0032	5,5	11	500	280	160	–
180	0,0016	0,0032	5,5	11	710	400	224	–
200	0,0015	0,0030	5,2	10	1000	560	315	–
225	0,0015	0,0030	5,2	10	1400	800	450	–
250	0,0014	0,0028	4,8	9,6	2000	1120	630	–
280	0,0014	0,0028	4,8	9,6	2800	1600	900	–
320, 321	0,0013	0,0026	4,5	8,9	4000	2240	1250	–
360	0,0013	0,0026	4,5	8,9	5600	3150	1800	–

1) At the distance of 1 m from the low speed shaft centre, angular backlash expressed in mm is obtained in by multiplying the value in rad stated in the table by 1 000 (1 rad = 3438').

2) Values valid in condition of nominal load.

Moment of inertia (of mass) J_1 [kg m²]

Train of gear i_N	Gear reducer size										
	100	125	140	160	180	200	225	250	280	320, 321	360
I											
2 ... 2,5	0,0026	0,0085	–	0,0299	–	0,0848	–	0,2617	–	0,8918	–
2,8 ... 3,15	0,0020	0,0068	0,0110	0,0238	0,0399	0,0667	0,1160	0,2067	0,3411	0,6987	1,1885
3,6 ... 4	0,0015	0,0045	0,0085	0,0167	0,0309	0,0466	0,0872	0,1433	0,2599	0,4872	0,8992
4,5 ... 5	0,0011	0,0034	0,0057	0,0131	0,0213	0,0354	0,0613	0,1091	0,1823	0,3698	0,6344
2I											
6,3 ... 12,5	0,0009	0,0029	0,0031	0,0091	0,0102	0,0292	0,0325	0,0893	0,0987	0,2812	0,3158
6,3 ... 12,5 ¹⁾	0,0014	0,0043	0,0045	0,0133	0,0144	0,0430	0,0463	0,1279	0,1373	0,3967	0,4313
14 ... 28	–	0,0014	0,0017	0,0046	0,0055	0,0151	0,0185	0,0518	0,0566	0,1448	0,1747
14 ... 28 ¹⁾	–	0,0022	0,0025	0,0067	0,0086	0,0216	0,025	0,0709	0,0757	0,1981	0,2555
3I											
28 ... 63	–	–	–	0,0019	0,0020	0,0060	0,0063	0,0181	0,0190	0,0599	0,0631
28 ... 63 ¹⁾	–	–	–	0,0023	0,0024	0,0074	0,0077	0,0220	0,0229	0,0715	0,0747
71 ... 160	–	–	–	0,0009	0,0009	0,0027	0,0028	0,0083	0,0085	0,0270	0,0278
71 ... 160 ¹⁾	–	–	–	0,0010	0,0010	0,0031	0,0031	0,0093	0,0095	0,0303	0,0310
CI											
4 ... 8	0,0013	0,0038	0,0042	0,0123	0,0137	0,0369	0,0414	0,1093	0,1281	0,3372	0,4004
9 ... 11,2	0,0009	0,0025	0,0033	0,0072	0,0105	0,0223	0,0321	0,0706	0,1001	0,2214	0,3146
13 ... 16	–	0,0015	0,0018	0,0051	0,0061	0,0158	0,0187	0,0502	0,0589	0,1496	0,1929
18, 20	–	0,0008	0,0010	0,0029	0,0035	0,0085	0,0102	0,0279	0,0328	0,1140	0,1319
25 ... 31,5	–	–	–	0,0016	–	0,0047	–	0,0158	–	–	–
C2I											
20 ... 31,5	–	–	–	0,0039	0,0042	0,0125	0,0133	0,0375	0,0398	0,1131	0,1214
36 ... 63	–	–	–	0,0017	0,0018	0,0055	0,0058	0,0172	0,0179	0,0548	0,0574
71 ... 100	–	–	–	0,0007	0,0007	0,0025	0,0026	0,0074	0,0076	0,0240	0,0248
125, 160	–	–	–	0,0004	0,0004	0,0013	0,0013	0,0038	0,0039	0,0133	0,0136
ICI											
32 ... 80	–	–	–	0,0010	0,0011	0,0032	–	–	–	–	–
100 ... 200	–	–	–	0,0005	0,0005	0,0015	–	–	–	–	–

1) Values valid for long model.

6 - Structural and operational details

Gear reducer input face

Following gear reducers have a machined surface and threaded holes for an eventual motor support etc. on gear reducer input side (also on opposite side for R I, R 2I sizes ≥ 140 , R 3I sizes ≥ 140 , model 4 excluded).

R 2I 50 ... 125

R CI 50 ... 100

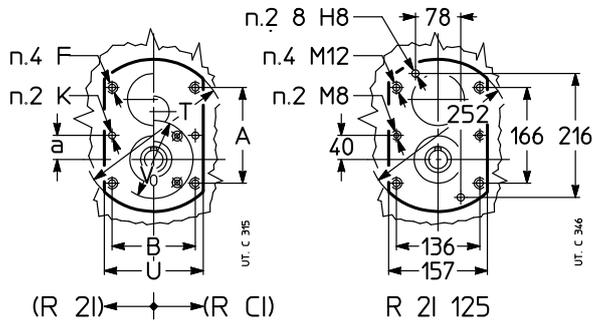

Gear reducer size		a	A	B	F	K Ø H8	T Ø	U
R 2I	R CI				1)	2)		
50	-	16	72	54	M 5	5	103	66
63, 64	50	20	81,5	66,5	M 5	5	119	80
80, 81	63 ... 81	25	106	80	M 6	6	149	96
100	100	31,3	125	108	M 8	8	187	129

1) Working length of thread $2 \cdot F$.
2) Working length of thread $1,6 \cdot K$.
For dimension V_0 (R CI only) see ch. 10.

R I 125 ... 360

R 2I 140 ... 360

R 3I 140 ... 360

R CI 125 ... 360

R C2I 140 ... 360

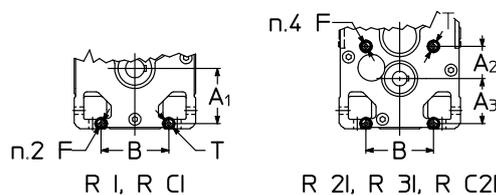

Gear reducer size		A ₁	A ₂	A ₃	B	F Ø 1)	T
R I, R CI	R 2I, R 3I, R C2I						
125, 140	140	138	81	113	162	M 12	25
160, 180	160, 180	165	96	135	201	M 16	32
200, 225	200, 225	207	115	162	250	M 20	40
250, 280	250, 280	258	143	203	310	M 24	48
320 ... 360	320 ... 360	327	180	252	386	M 30	60

1) Working length of thread $1,25 \cdot F$.
If spigot is required, consult us.

The input face of gear reducers have a **machined flange** and **holes** for eventual motor fastening etc.

R 3I 63 ... 125

R ICI 50 ... 200

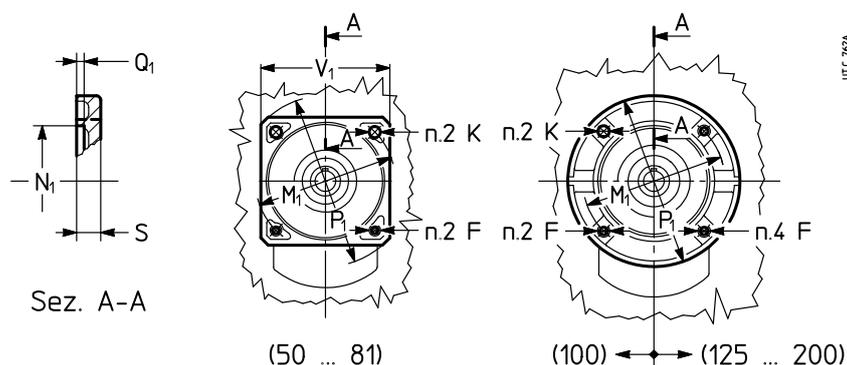

Gear reducer size		F	K Ø	M ₁ Ø	N ₁ Ø	P ₁ Ø	V ₁ □	Q ₁	S
R 3I	R ICI	1)			H7				
63, 64	50	M 8	9,5	115	95	140	105	4	11
80, 81	63 ... 81	M 8	9,5	130	110	160	120	4,5	12
100	100	M 10	11,5	165	165	200	-	4,5	14
125	125, 140	M 10	-	165	165	200	-	4,5	16
-	160, 180	M 12	-	215	215	250	-	5	18
-	200	M 12	-	265	265	300	-	5	20

1) Working length of thread $1,25 \cdot F$.

6 - Structural and operational details

High and low speed shaft end

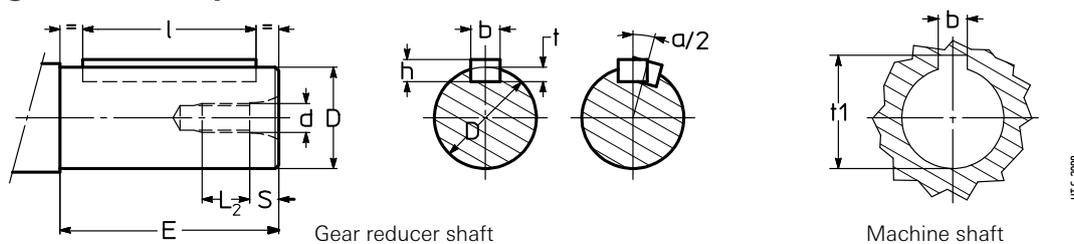

Ø D ₃₎	Shaft end				α/2 ²⁾ arc min	Key		Keyway		
	E ¹⁾	d Ø	S	L ₂ ¹⁾		b × h × l ¹⁾ h9 h11	b h9 hub N9 shaft	t shaft	t ₁ hub	
11	j 6	23	M 5	3,6	9,4	—	4 × 4 × 18	4	2,5	12,7
14	j 6	30	M 6	4,6	11,4	—	5 × 5 × 25	5	3	16,2
16	j 6	30	M 6	4,6	11,4	—	5 × 5 × 25	5	3	18,2
19	j 6	40 (30)	M 6	4,6	11,4 (13,4)	5,43	6 × 6 × 36 (25)	6	3,5	21,8
24	j 6	50 (36)	M 8	5,9	15,1 (17,1)	5,16	8 × 7 × 45 (25)	8	4	27,2
28	j 6	60	M 8	5,9	15,1	—	8 × 7 × 45	8	4	31,2
30	—	58	M 10	7,6	20,4	4,13	8 × 7 × 45	8	4	33,2
32	k 6	80 (58)	M 10	7,6	18,4 (20,4)	3,87	10 × 8 × 70 (50)	10	5	35,3
38	k 6	80 (58)	M 10	7,6	18,4 (20,4)	3,27	10 × 8 × 70 (50)	10	5	41,3
40	—	58	M 10	7,6	20,4	3,7	12 × 8 × 50	12	5	43,3
42	k 6	110	M 12	9,5	22,5	—	12 × 8 × 90	12	5	45,3
45	k 6	110	M 12	9,5	22,5	—	14 × 9 × 90	14	5,5	48,8
48	k 6	110 (82)	M 12	9,5	22,5 (26,5)	3,08	14 × 9 × 90 (70)	14	5,5	51,8
55	m 6	110	M 12	9,5	22,5	—	16 × 10 × 90	16	6	59,3
60	m 6	140 (105)	M 16	12,7	27,3 (35,3)	2,46	18 × 11 × 110 (90)	18	7	64,4
70	m 6	140 (105)	M 16	12,7	27,3 (35,3)	2,55	20 × 12 × 125 (90)	20	7,5	74,9
75	m 6	140	M 16	12,7	27,3	—	20 × 12 × 125	20	7,5	79,9
80	—	130	M 20	16	44	2,23	22 × 14 × 110	22	9	85,4
90	m 6	170 (130)	M 20	16	34 (44)	1,99	25 × 14 × 140 (110)	25	9	95,4
95	m 6	170	M 20	16	34	—	25 × 14 × 140	25	9	100,4
100	—	165	M 24	19	41	1,79	28 × 16 × 140	28	10	106,4
110	m 6	210 (165)	M 24	19	41	1,63	28 × 16 × 180 (140)	28	10	116,4
125	—	200 ⁴⁾	M 30	22	45	1,71	32 × 18 × 180	32	11	132,4
140	—	200	M 30	22	45	1,52	36 × 20 × 180	36	12	148,4
160	—	240	M 36	27	54	1,33	40 × 22 × 220	40	13	169,4
180	—	240	M 36	27	54	1,18	45 × 25 × 220	45	15	190,4

1) Values in brackets are for short shaft end.

2) Maximum angular misalignment between double extension shaft keys.

3) Tolerance valid only for high speed shaft ends. For low speed shaft ends see ch. 17 (1) and (2).

4) Value **not to** standard.

Hollow low speed shafts

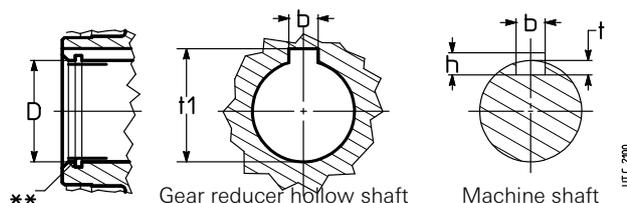

Hole D Ø H7 ^{**}	Parallel key b × h × l [*] h9 h11	Keyway		
		b H9 hub N9 shaft	t shaft	t ₁ hub
19	6 × 6 × 50	6	3,5	21,8
24	8 × 7 × 63	8	4	27,3
30	8 × 7 × 63	8	4,5 ¹⁾	32,7 ¹⁾
32	10 × 8 × 70	10	5	35,3
38	10 × 8 × 90	10	5,5 ¹⁾	40,7 ¹⁾
40	12 × 8 × 90	12	5	43,3
48	14 × 9 × 110	14	5,5	51,8
60	18 × 11 × 140	18	7	64,4
70	20 × 12 × 180	20	8 ¹⁾	74,3 ¹⁾
80	22 × 14 × 200	22	9	85,4
90	25 × 14 × 200	25	9	95,4
100	28 × 16 × 250	28	10	106,4
110	28 × 16 × 250	28	10	116,4
125	32 × 18 × 320	32	11	132,4
140	36 × 20 × 320	36	12	148,4
160	40 × 22 × 400	40	14 ¹⁾	168,3 ¹⁾
180	45 × 25 × 400	45	15	190,4

* Recommended length.

** Each hollow shaft type (standard, stepped, with shrink disc) has a slightly oversized diameter **D** (at the input) to facilitate the assembly of gear reducer on machine shaft end: this, however, does not affect the connection reliability.

1) Values **not to** standard.

6 - Structural and operational details

Reference groove

The reference for identification of the hollow low speed shaft side opposite to which it is advisable to apply the radial load, is provided by a groove as shown in the drawing below. The position of the reference groove is identified by the symbol ● in the drawings «Design» of ch. 8, 10, 12 and 14.

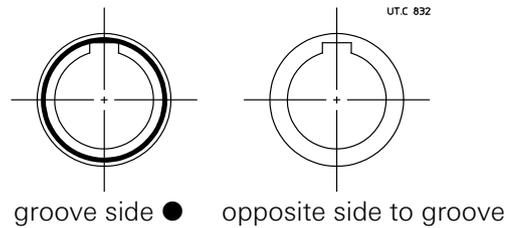

Plug dimensions

Gear reducer size	40, 50	63 ... 81	100 ... 140	160 ... 280	320 ... 360
Size threaded holes	G 1/4"	M16 x 1,5	G 1/2"	G 3/4"	G 1"

Filler and level plugs

2I, 3I, 4I (100, 125)
mounting position **V6**

ICI (100 ... 200)
mounting position **B6¹⁾**

C3I (100 ... 125)
mounting position **B6¹⁾**

3I (125)
mounting position **V5¹⁾**

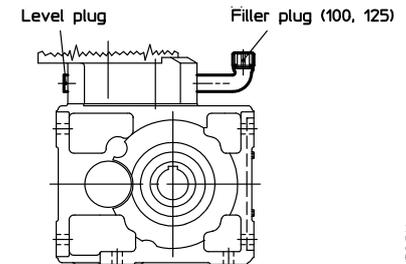
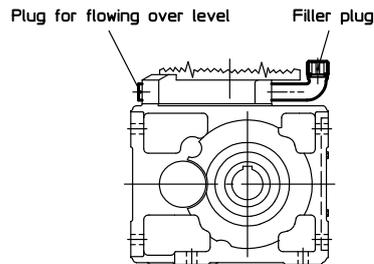
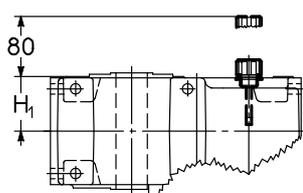

1) For high speed continuous duty an expansion tank is envisaged: consult us.

Expansion tank (sizes 100 ... 360)

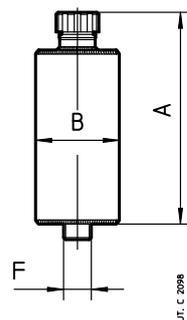

Gear reducer size	A	B	F	Plug
100 ... 140	131	46	G1/2"	1/2"
160 ... 280	205	80	G3/4"	3/4"
320 ... 360	230	102	G1"	1"

Cap overall dimension (sizes 63, 64, 125 and 140)

In the gear reducers and garmotors stated in the table, the cap opposite to high speed shaft overhangs of 4 mm from H₁ dimension (see ch. 8,10, 12, 14), due to backstop device pre-arrangement.

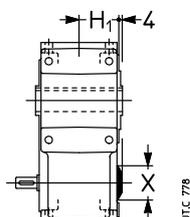

Gear reducer size	X
63, 64	47
125	72
140	72

6 - Structural and operational details

Fastening tapped holes (sizes 125 ... 321)

The relevant through holes to be realized on the driven machine must be all of equal diameter for sizes 140, 200 and 250 ($\varnothing 15$, $\varnothing 21$ and $\varnothing 25$, respectively) as the 2 holes of smaller diameter are not in the position of $22^\circ 30'$.

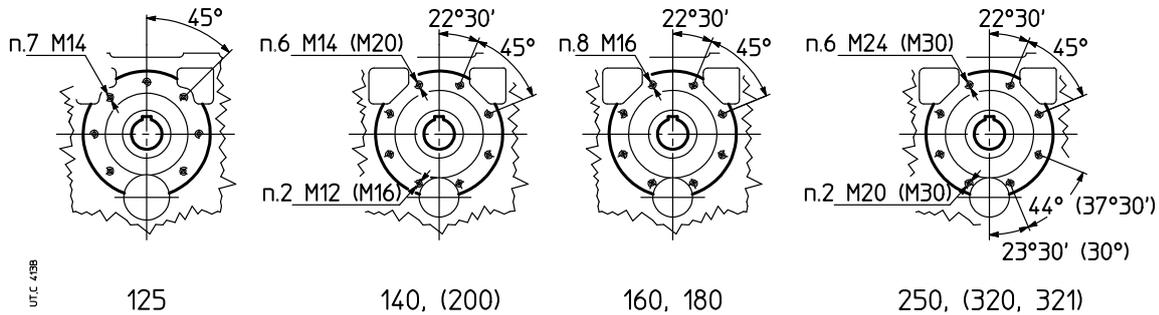

Reaction recess (2I, 3I, 4I sizes 40 ... 125)

Sizes 2I, 3I, 4I 40 ... 125 have a housing with a reaction recess having machined lateral surfaces, laying on the high speed side (opposite to groove), for the seating of springs and torque arm end for shaft mounting (see ch. 17 «Shaft mounting arrangements»).

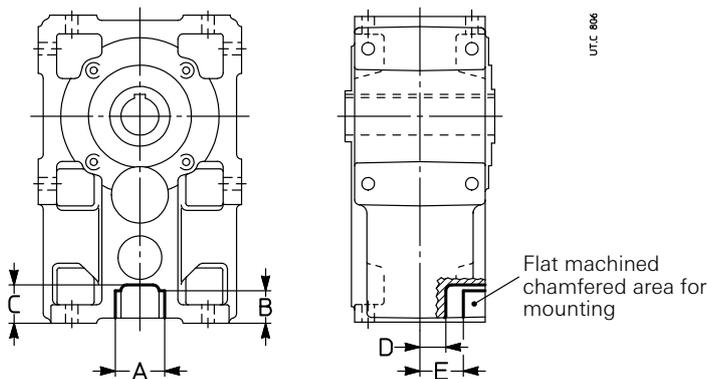

Gear reducer size	A	B	C	D	E
H11			≈		
40	23	18,5	22	14	25
50	29,7	23,5	26	15,5	28
63, 64	32,5	25,5	31	22,5	36,5
80, 81	45,8	27	36	27	41
100	63	27	38,5	36	54,5
125	67	37	52	46	64

Low speed shaft zone (sizes 140, 180, 225, 280, 360)

In standard model helical gear reducers the perspective pulley, if mounted against shaft shoulder (always advisable), can have a maximum diameter of:

- **R I**, at the distance of $H1 + Q + 3$ (ch. 8), 115 (size 140), 150 (size 180), 180 (size 225), 230 (size 280), 300 (size 360).
- **R 2I, R 3I**, at the distance $H1 + Q + 3$ (ch. 8), 315 (size 140), 400 (size 180), 500 (size 225), 630 (size 280), 800 (size 360).

The use of pulleys with larger diameter is allowed on condition that they don't overhang from the shaft end and provided that the maximum radial load values are observed (see ch.16); consult us if need be.

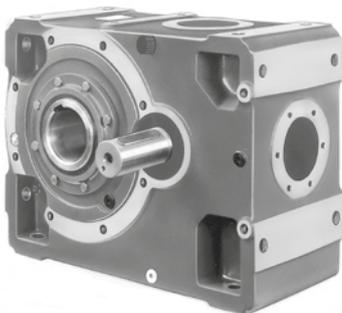

Helical gear reducers
(I 140, 180, 225, 280, 360)

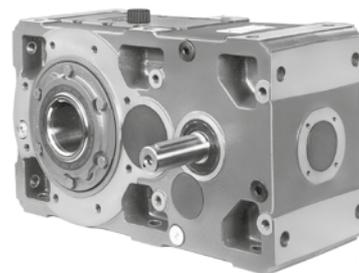

Helical gear reducers
(2I, 3I 140, 180, 225, 280, 360)

6 - Structural and operational details

Directions of rotation

The correspondence between the high speed shaft (of gear reducer or gearmotor) and low speed shaft is stated at ch. 8, 10, 12, 14 according to design and train of gears. For the interpretation of arrows, refer to the following 3D sketches.

Helical gear reducer R 2I UP2A

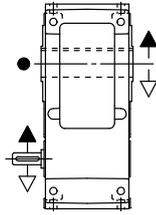

UT. C 2096

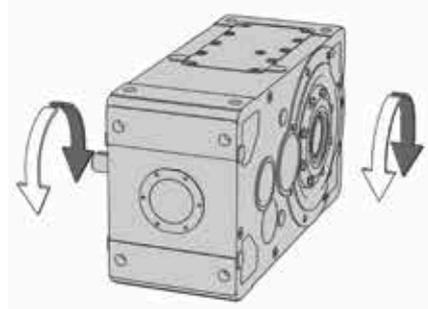

Bevel helical gear reducer R CI UO2D

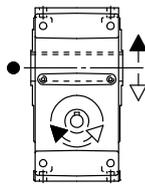

UT. C 2096



1) Direction of rotation of the second high speed shaft extension not in view.

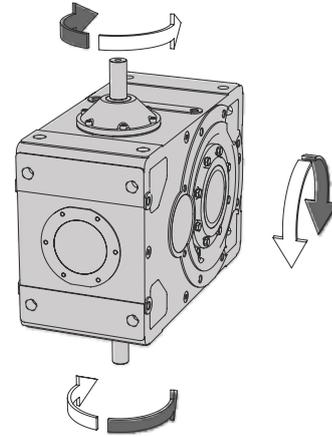

6

Bevel helical gearmotor MR C2I UO2A

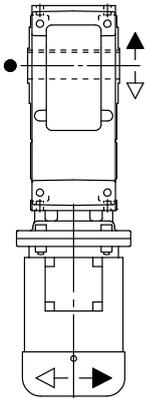

UT. C 2096

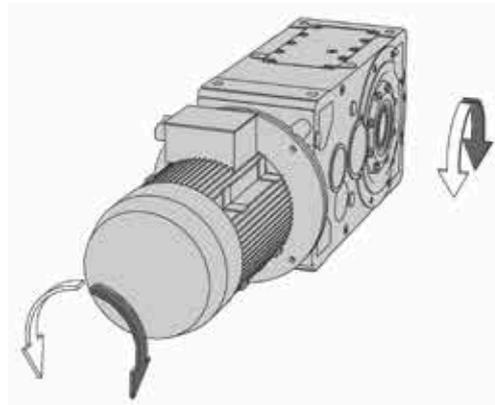

Bearing and/or gear pair forced lubrication: hydraulic circuit diagram

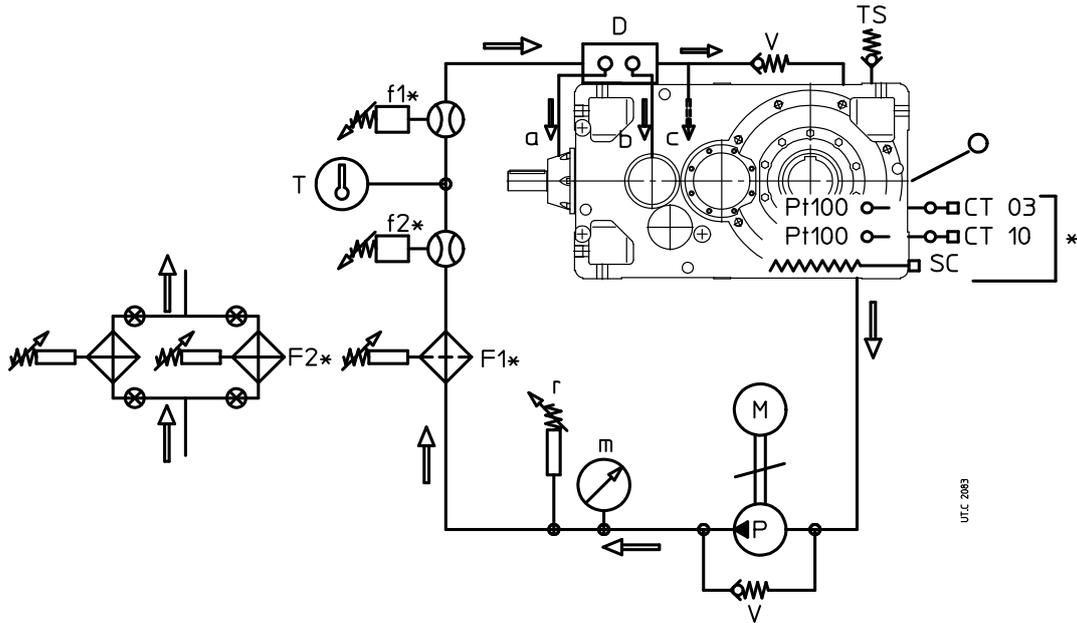

Standard

a, b, c	Gear pair/bearing pipes
m	Pressure gauge (0 ÷ 16 bar)
M	Motor pump
P	Pump
T	Thermometer
V	Safety valve
r	Minimum pressure gauge
TS	Filler plug
D	Distributor
	Oil level (approximate)

On request

Pt 100*	Oil temperature probe (loose)*
f1	Electric flow switch: vertical mounting
f2	Visible flow switch
F1	Filter
F2	Exchange filters
CT03*, CT10*	Signalling device (loose)*
SC*	Heater

* On request, but necessary for gear reducer starting with $T_{ambient} (= T_{oil}) \leq 25 \text{ }^\circ\text{C}$: preheat the oil with the heater.

NOTES: The bearings and/or the gear pairs to be forced lubricated are defined by Rossi according to gear reducer and application.

CT03: set the operating threshold at 50 °C (stopping the heater supply) and the reset threshold at 30 °C.

CT10: set the operating threshold at 30 °C to start gear reducer and motor pump; set the reset threshold at 10 °C and the safety threshold at 90 °C.

For the gear reducer starting at $T_{ambient} (= T_{oil}) \leq 0 \text{ }^\circ\text{C}$ the same logic is valid, but the devices CT03 and CT10 must be set according to the real ambient temperature.

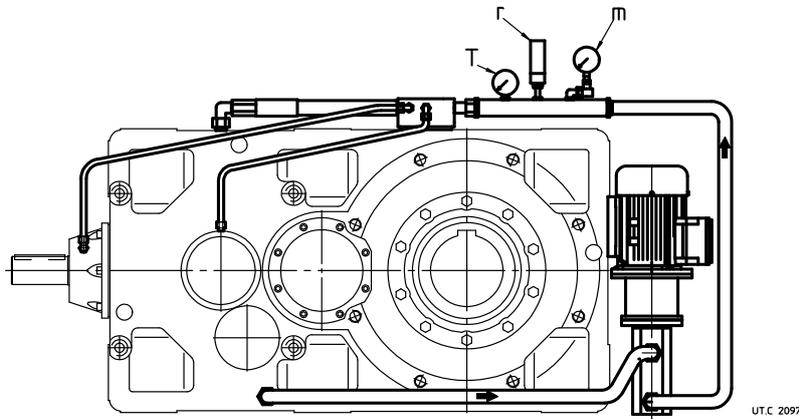

Sketch of forced lubrication with motor pump: the exact position of motor pump depends on the gear reducer size, train of gears, mounting position and available overall dimensions: for this reason, on request, a drawing of the specific solution will be supplied; the pipes will be realized with suction and delivery flexible pipes and with rigid pipes between the distributor and the bearings.

6 - Structural and operational details

Bearing and/or gear pair forced lubrication with oil/air or oil/water independent cooling unit: hydraulic circuit diagram

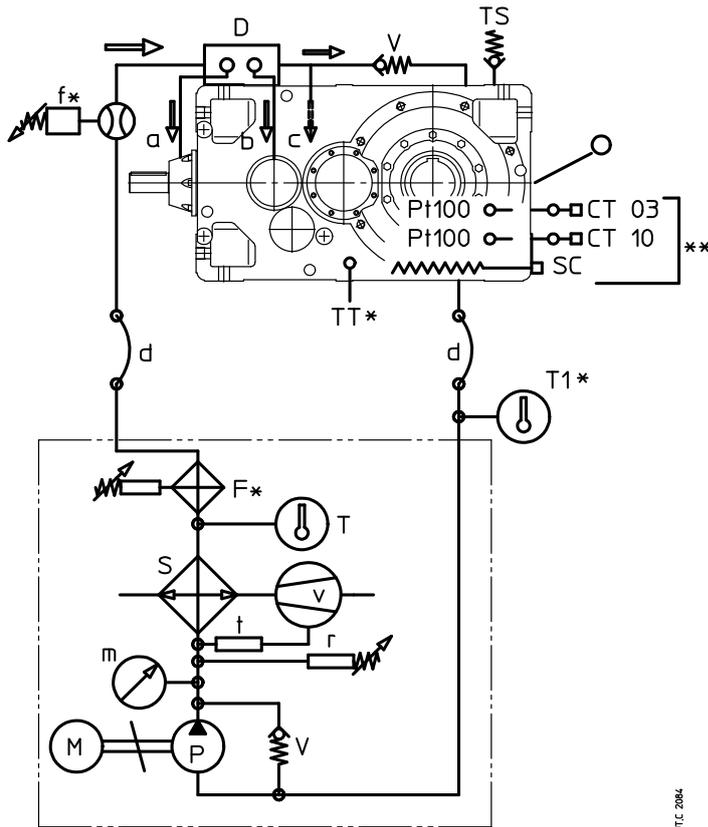

Standard

a, b, c	Gear pair/bearing pipes
d	Flexible connection (by Buyer)
m	Pressure gauge (0 ÷ 16 bar)
M	Motor pump
P	Pump
S	Oil/air or oil/water exchanger
v	Motor fan (UR O/A...)
t	Fan thermostat 0 ÷ 90°C (UR O/A...)
T	Thermometer 0 ÷ 120°C
V	Safety valve
r	Minimum pressure gauge
TS	Filler plug
D	Distributor
☉	Oil level (approximate)

On request

Pt 100*	Oil temperature probe (loose)*
f	Flow switch (loose)
F	Filter with electric blockage warning (with UR O/A... loose)
CT03*	Signalling device (loose)*
CT10*	Signalling device (loose)*
T1	Thermometer 0 ÷ 120°C
TT	Bi-metal type thermometer
SC*	Heater

* On request but necessary for gear reducer starting with $T_{\text{ambient}} (= T_{\text{oil}}) \leq 25^\circ\text{C}$: preheat the oil with heater.

NOTES: Bearings and/or gear pairs to be forced lubricated are defined by Rossi according to gear reducer and application.

CT03: set the operating threshold at 50 °C (stopping the heater supply) and the reset threshold at 30 °C.

CT10: set the operating threshold at 30 °C to start gear reducer and motor pump; set the reset threshold at 10 °C and the safety threshold at 90 °C.

For gear reducer starting with $T_{\text{ambient}} (= T_{\text{oil}}) \leq 0^\circ\text{C}$ the same logic is valid, but the devices CT03 and CT10 must be set according to the real ambient temperature.

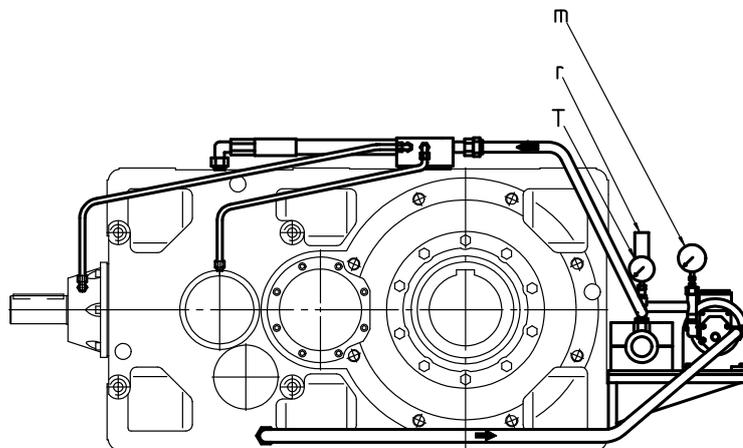

Sketch of forced lubrication with cooling unit; the exact position of cooling unit depends on the gear reducer size, train of gears, mounting position and available overall dimensions: for this reason, on request, a drawing of the specific solution will be supplied; the pipes will be realized with suction and delivery flexible pipes and with rigid pipes between the distributor and the bearings.

6 - Structural and operational details

Maximum bending moment of flange MR

In case of assembly of motors supplied by the customer, verify that the static bending moment M_b generated by motor weight on the counter flange of gear reducer is lower than the value allowed M_{bmax} , stated in the table:

$$M_b \leq M_{bmax}$$

where:

$$M_b = G \cdot (X + HF) / 1000 \text{ [N m]}$$

G [N] motor weight; numerically nearly equal to motor mass, expressed in kg, multiplied by 10.

X [mm] distance from motor center of gravity from flange surface

HF [mm] supplied in the table, according to gear reducer size and flange diameter P_1

Very long and thin motors, though with bending moments within the prescribed limits, may generate anomalous vibrations during the operation. In these cases it is necessary to foresee a proper additional motor support (see motor specific documentation).

Loads higher than permissible loads may be present in dynamical applications where the gearmotor is subjected to translations, rotations or oscillations (e.g.: shaft mounting arrangements): consult us for the study of every specific case.

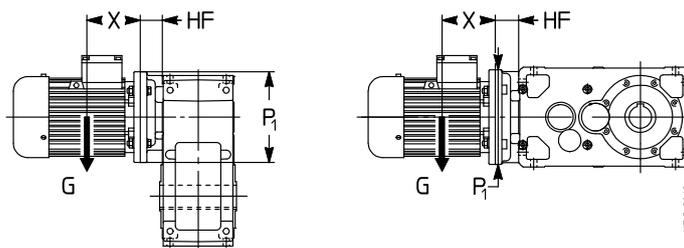

Bending moment M_{bmax} and dimension HF

Size	P_1 Ø	2I, 3I		4I		CI		ICI		C3I		C2I	
		HF mm	M_{bmax} N m	HF mm	M_{bmax} N m	HF mm	M_{bmax} N m	HF mm	M_{bmax} N m	HF mm	M_{bmax} N m	HF ¹⁾ mm	M_{bmax} N m
40	140	28	28	-	-	31	63	31	63	-	-	-	-
	160	-	-	-	-	31	63	31	63	-	-	-	-
50	140	38	56	-	-	31	63	31	63	50	63	-	-
	160	30	56	-	-	31	63	31	63	50	63	-	-
	200	-	-	-	-	31	63	31	63	-	-	-	-
63, 64	140	31	63	51	63	-	-	-	-	-	-	-	-
	160	31	63	51	63	38	112	38	112	65	112	-	-
	200	31	112	-	-	38	112	38	112	65	112	-	-
80, 81	160	38	112	66	112	-	-	38	112	65	112	-	-
	200	38	200	66	112	38	200	38	112	65	112	-	-
	250	38	200	-	-	50	200	-	-	-	-	-	-
100	200	45	280	79	280	45	280	45	280	78	280	-	-
	250	45	280 ²⁾	-	-	45	450	45	280	-	-	-	-
	300	65	450	-	-	65	450	-	-	-	-	-	-
125	200	55	500	100	500	-	-	55	500	99	500	-	-
	250	55	500	100	500	-	-	55	500	99	500	-	-
	300	61	1 400	-	-	70	560	56	900	-	-	-	-
	350	75	1 400	-	-	100	900	-	-	-	-	-	-
140	200	-	-	-	-	-	-	55	500	-	-	-	-
	250	30	560	-	-	-	-	55	500	-	-	45 (30)	560
	300	55	560	-	-	70	560	56	900	-	-	70 (55)	900 ³⁾
	350	75	900	-	-	100	900	-	-	-	-	-	-
160, 180	250	50	1 250	-	-	-	-	67	710	-	-	55	180
	300	50	1 250	-	-	-	-	67	710	-	-	70 (50)	1 250
	350	75	1 250	-	-	102	1 250	80	1 120	-	-	100 (75)	1 250
	400	65	1 250	-	-	102	1 250	-	-	-	-	-	-
	450	95	2 000	-	-	132	1 250	-	-	-	-	-	-
200, 225	300	67	2 500	-	-	-	-	80	1 800	-	-	72	630
	350	67	2 500	-	-	100	2 500	80	1 800	-	-	102 (67)	2 500
	400	67	2 500	-	-	100	2 500	80	1 800	-	-	102 (67)	2 500
	450	97	2 500	-	-	130	2 500	90	1 800	-	-	132 (97)	2 500
	550	97	4 000	-	-	130	4 000	-	-	-	-	-	-
250, 280	350	65	4 500	-	-	-	-	-	-	-	-	100	1 400
	400	65	4 500	-	-	-	-	-	-	-	-	100 (45)	4 500
	450	95	4 500	-	-	130	4 500	-	-	-	-	130 (75)	4 500
	550	95	4 500	-	-	130	4 500	-	-	-	-	130 (75)	4 500
	660	115	4 750	-	-	160	4 750	-	-	-	-	-	-
320 ... 360	400	85	9 000	-	-	-	-	-	-	-	-	100	1 600
	450	85	9 000	-	-	-	-	-	-	-	-	130	2 800
	550	95	9 000	-	-	-	-	-	-	-	-	130 (65)	9 000
	660	115	9 000	-	-	-	-	-	-	-	-	160 (85)	9 000

1) The values in bracket is valid for design UO2V, UO2Vsin, UO2R, UO2Rsin.

2) 450 N m for MR 2I.

3) 560 N m for design UO2V, UO2Vsin, UO2R, UO2Rsin.

7 – Selection tables

(helical gear reducers)

7 - Selection tables (helical gear reducers)



$n_{N2} \cdot L_h$ min ⁻¹ · h	i_N	P_{N2} kW M_{N2} N m ... / i																i_N	n_1 min ⁻¹	n_{N2} min ⁻¹	
		50	63	64	80	81	100	125	140	160	180	200	225	250	280	320	321				360
90 000 000	2	-	-	-	-	-	-	1 140 1/2	-	2 180 1/1,95	-	4 080 1/2,05	-	7 040 1/2	-	12 210 1/1,95	15 260 1/1,95	-			
80 000 000	2,24	-	-	-	-	-	-	1 170 1/2,28	1 540 1/2,3	2 240 1/2,21	3 050 1/2,24	4 180 1/2,2	5 700 1/2,27	7 400 1/2,33	10 120 1/2,3	12 810 1/2,26	16 020 1/2,26	17 860 1/2,29			
	2	-	-	-	-	-	-	1 180 1/2	-	2 260 1/1,95	-	4 220 1/2,05	-	7 290 1/2	-	12 630 1/1,95	15 780 1/1,95	-			
71 000 000	2,5	-	175 1/2,53	-	330 1/2,44	-	650 1/2,55	1 220 1/2,53	1 610 1/2,53	2 350 1/2,44	3 250 1/2,5	4 370 1/2,55	5 820 1/2,43	7 580 1/2,53	10 570 1/2,53	13 120 1/2,44	16 390 1/2,44	18 610 1/2,5			
	2,24	-	-	-	-	-	-	1 210 1/2,28	1 590 1/2,3	2 320 1/2,21	3 160 1/2,24	4 320 1/2,2	5 900 1/2,27	7 660 1/2,33	10 470 1/2,3	13 260 1/2,26	16 570 1/2,26	18 480 1/2,29			
	2	-	-	-	-	-	-	1 220 1/2	-	2 330 1/1,95	-	4 370 1/2,05	-	7 530 1/2	-	13 050 1/1,95	16 310 1/1,95	-			
63 000 000	2,8	-	-	-	-	-	-	1 250 1/2,75	1 610 1/2,82	2 400 1/2,81	3 310 1/2,83	4 570 1/2,82	5 830 1/2,83	8 350 1/2,81	10 580 1/2,82	13 420 1/2,81	16 780 1/2,81	19 000 1/2,83			
	2,5	-	180 1/2,53	-	345 1/2,44	-	670 1/2,55	1 270 1/2,53	1 660 1/2,53	2 430 1/2,44	3 360 1/2,5	4 530 1/2,55	6 020 1/2,43	7 840 1/2,53	10 930 1/2,53	13 570 1/2,44	16 960 1/2,44	19 260 1/2,5			
	2,24	-	-	-	-	-	-	1 250 1/2,28	1 650 1/2,3	2 390 1/2,21	3 260 1/2,24	4 470 1/2,2	6 100 1/2,27	7 910 1/2,33	10 820 1/2,3	13 700 1/2,26	17 120 1/2,26	19 100 1/2,29			
	2	-	-	-	-	-	-	1 260 1/2	-	2 410 1/1,95	-	4 520 1/2,05	-	7 790 1/2	-	13 500 1/1,95	16 880 1/1,95	-			
56 000 000	3,15	-	190 1/3,28	-	355 1/3,13	-	690 1/3,27	1 310 1/3,28	1 680 1/3,13	2 510 1/3,13	3 380 1/3,25	4 660 1/3,27	6 170 1/3,18	8 120 1/3,28	11 830 1/3,19	14 020 1/3,13	17 530 1/3,13	19 390 1/3,25			
	2,8	-	-	-	-	-	-	1 300 1/2,75	1 660 1/2,82	2 480 1/2,81	3 430 1/2,83	4 720 1/2,82	6 030 1/2,83	8 640 1/2,81	10 940 1/2,82	13 890 1/2,81	17 360 1/2,81	19 660 1/2,83			
	2,5	-	190 1/2,53	-	355 1/2,44	-	695 1/2,55	1 310 1/2,53	1 720 1/2,53	2 510 1/2,44	3 470 1/2,5	4 680 1/2,55	6 220 1/2,43	8 100 1/2,53	11 300 1/2,53	14 020 1/2,44	17 530 1/2,44	19 900 1/2,5			
	2,24	-	-	-	-	-	-	1 290 1/2,28	1 700 1/2,3	2 480 1/2,21	3 380 1/2,24	4 620 1/2,2	6 310 1/2,27	8 190 1/2,33	11 200 1/2,3	14 170 1/2,26	17 720 1/2,26	19 760 1/2,29			
	2	-	-	-	-	-	-	1 300 1/2	-	2 490 1/1,95	-	4 660 1/2,05	-	8 040 1/2	-	13 940 1/1,95	17 420 1/1,95	-			
50 000 000	3,55	-	-	-	-	-	-	1 340 1/3,62	1 710 1/3,64	2 420 1/3,62	3 510 1/3,6	4 760 1/3,57	6 290 1/3,67	8 730 1/3,62	11 250 1/3,64	14 620 1/3,5	18 280 1/3,5	20 140 1/3,6			
	3,15	-	195 1/3,28	-	365 1/3,13	-	715 1/3,27	1 360 1/3,28	1 740 1/3,13	2 590 1/3,13	3 500 1/3,25	4 830 1/3,27	6 380 1/3,18	8 400 1/3,28	12 240 1/3,19	14 510 1/3,13	18 140 1/3,13	20 060 1/3,25			
	2,8	-	-	-	-	-	-	1 340 1/2,75	1 720 1/2,82	2 570 1/2,81	3 540 1/2,83	4 880 1/2,82	6 230 1/2,83	8 930 1/2,81	11 310 1/2,82	14 350 1/2,81	17 940 1/2,81	20 320 1/2,83			

For n_1 lower than 560 min⁻¹ see page 107.

7 - Selection tables (helical gear reducers)



$n_{N2} \cdot L_h$ min ⁻¹ · h	i_N	P_{N2} kW																i_N	n_1 min ⁻¹	n_{N2} min ⁻¹	
		M_{N2} N m																			
		... / i																			
		50	63	64	80	81	100	125	140	160	180	200	225	250	280	320	321	360			
50 000 000	2,5	-	195 I/2,53	-	365 I/2,44	-	720 I/2,55	1 350 I/2,53	1 780 I/2,53	2 590 I/2,44	3 590 I/2,5	4 840 I/2,55	6 440 I/2,43	8 380 I/2,53	11 690 I/2,53	14 510 I/2,44	18 140 I/2,44	20 590 I/2,5			
	2,24	-	-	-	-	-	-	1 330 I/2,28	1 760 I/2,3	2 550 I/2,21	3 480 I/2,24	4 770 I/2,2	6 510 I/2,27	8 450 I/2,33	11 560 I/2,3	14 630 I/2,26	18 290 I/2,26	20 390 I/2,29			
	2	-	-	-	-	-	-	1 350 I/2	-	2 580 I/1,95	-	4 830 I/2,05	-	8 330 I/2	-	14 440 I/1,95	18 050 I/1,95	-			
45 000 000	4	-	185 I/4	-	375 I/4,16	-	560 I/3,92	1 140 I/4	1 780 I/4,08	2 690 I/4,13	3 390 I/4,15	4 990 I/4,13	6 520 I/4,07	8 450 I/4	12 300 I/4,08	15 710 I/4,07	19 640 I/4,07	20 890 I/4			
	3,55	-	-	-	-	-	-	1 390 I/3,62	1 770 I/3,64	2 500 I/3,62	3 630 I/3,6	4 930 I/3,57	6 510 I/3,67	9 030 I/3,62	11 640 I/3,64	15 130 I/3,5	18 910 I/3,5	20 840 I/3,6			
	3,15	-	200 I/3,28	-	380 I/3,13	-	740 I/3,27	1 400 I/3,28	1 790 I/3,13	2 680 I/3,13	3 620 I/3,25	4 990 I/3,27	6 600 I/3,18	8 680 I/3,28	12 650 I/3,19	14 990 I/3,13	18 740 I/3,13	20 730 I/3,25			
	2,8	-	-	-	-	-	-	1 390 I/2,75	1 780 I/2,82	2 660 I/2,81	3 670 I/2,83	5 050 I/2,82	6 440 I/2,83	9 240 I/2,81	11 700 I/2,82	14 850 I/2,81	18 560 I/2,81	21 020 I/2,83			
	2,5	-	200 I/2,53	-	380 I/2,44	-	740 I/2,55	1 400 I/2,53	1 840 I/2,53	2 680 I/2,44	3 710 I/2,5	4 990 I/2,55	6 640 I/2,43	8 650 I/2,53	12 070 I/2,53	14 970 I/2,44	18 720 I/2,44	21 250 I/2,5			
	2,24	-	-	-	-	-	-	1 380 I/2,28	1 820 I/2,3	2 650 I/2,21	3 610 I/2,24	4 940 I/2,2	6 740 I/2,27	8 750 I/2,33	11 970 I/2,3	15 150 I/2,26	18 940 I/2,26	21 130 I/2,29			
	2	-	-	-	-	-	-	1 390 I/2	-	2 680 I/1,95	-	5 010 I/2,05	-	8 630 I/2	-	14 960 I/1,95	18 700 I/1,95	-			
40 000 000	4,5	-	-	-	-	-	-	1 160 I/4,45	1 750 I/4,5	2 730 I/4,5	3 550 I/4,67	5 080 I/4,5	6 500 I/4,67	9 330 I/4,47	11 370 I/4,5	16 180 I/4,5	20 220 I/4,5	22 220 I/4,6			
	4	-	190 I/4	-	390 I/4,16	-	580 I/3,92	1 180 I/4	1 840 I/4,08	2 780 I/4,13	3 500 I/4,15	5 170 I/4,13	6 750 I/4,07	8 740 I/4	12 720 I/4,08	16 260 I/4,07	20 320 I/4,07	21 610 I/4			
	3,55	-	-	-	-	-	-	1 430 I/3,62	1 830 I/3,64	2 590 I/3,62	3 760 I/3,6	5 090 I/3,57	6 730 I/3,67	9 330 I/3,62	12 030 I/3,64	15 640 I/3,5	19 550 I/3,5	21 530 I/3,6			
	3,15	-	210 I/3,28	-	390 I/3,13	-	765 I/3,27	1 450 I/3,28	1 860 I/3,13	2 770 I/3,13	3 740 I/3,25	5 160 I/3,27	6 830 I/3,18	8 980 I/3,28	13 080 I/3,19	15 510 I/3,13	19 390 I/3,13	21 450 I/3,25			
	2,8	-	-	-	-	-	-	1 430 I/2,75	1 840 I/2,82	2 740 I/2,81	3 780 I/2,83	5 210 I/2,82	6 650 I/2,83	9 530 I/2,81	12 070 I/2,82	15 330 I/2,81	19 160 I/2,81	21 700 I/2,83			
	2,5	-	210 I/2,53	-	390 I/2,44	-	770 I/2,55	1 450 I/2,53	1 900 I/2,53	2 770 I/2,44	3 840 I/2,5	5 170 I/2,55	6 880 I/2,43	8 960 I/2,53	12 500 I/2,53	15 510 I/2,44	19 390 I/2,44	22 020 I/2,5			
	2,24	-	-	-	-	-	-	1 430 I/2,28	1 890 I/2,3	2 740 I/2,21	3 740 I/2,24	5 120 I/2,2	6 990 I/2,27	9 070 I/2,33	12 410 I/2,3	15 710 I/2,26	19 630 I/2,26	21 900 I/2,29			
2	-	-	-	-	-	-	1 450 I/2	-	2 770 I/1,95	-	5 190 I/2,05	-	8 950 I/2	-	15 510 I/1,95	19 390 I/1,95	-				

For n_1 lower than 560 min⁻¹ see page 107.

7 - Selection tables (helical gear reducers)



$n_{N2} \cdot L_h$ min ⁻¹ · h	i_N	P_{N2} kW M_{N2} N m ... / i																i_N	n_1 min ⁻¹	n_{N2} min ⁻¹	
		50	63	64	80	81	100	125	140	160	180	200	225	250	280	320	321				360
35 500 000	5	-	190 1/5	-	390 1/5,2	-	585 1/4,82	1 190 1/5	1 790 1/5	2 770 1/4,92	3 440 1/5,07	5 160 1/4,92	6 600 1/5,07	8 340 1/5,08	13 050 1/5	16 490 1/4,92	20 610 1/4,92	22 790 1/5,07			
	4,5	-	-	-	-	-	1 200 1/4,45	1 810 1/4,5	2 820 1/4,5	3 670 1/4,67	5 250 1/4,5	6 730 1/4,67	9 650 1/4,47	11 770 1/4,5	16 740 1/4,5	20 920 1/4,5	22 980 1/4,6				
	4	-	195 1/4	-	405 1/4,16	-	600 1/3,92	1 220 1/4	1 900 1/4,08	2 870 1/4,13	3 620 1/4,15	5 340 1/4,13	6 970 1/4,07	9 030 1/4	13 150 1/4,08	16 800 1/4,07	21 000 1/4,07	22 340 1/4			
	3,55	-	-	-	-	-	1 480 1/3,62	1 890 1/3,64	2 680 1/3,62	3 890 1/3,6	5 270 1/3,57	6 960 1/3,67	9 650 1/3,62	12 440 1/3,64	16 180 1/3,5	20 220 1/3,5	22 280 1/3,6				
	3,15	-	215 1/3,28	-	405 1/3,13	-	790 1/3,27	1 500 1/3,28	1 910 1/3,13	2 860 1/3,13	3 860 1/3,25	5 330 1/3,27	7 050 1/3,18	9 270 1/3,28	13 500 1/3,19	16 010 1/3,13	20 010 1/3,13	22 140 1/3,25			
	2,8	-	-	-	-	-	1 480 1/2,75	1 900 1/2,82	2 840 1/2,81	3 920 1/2,83	5 400 1/2,82	6 890 1/2,83	9 870 1/2,81	12 510 1/2,82	15 880 1/2,81	19 850 1/2,81	22 480 1/2,83				
	2,5	-	215 1/2,53	-	405 1/2,44	-	795 1/2,55	1 500 1/2,53	1 970 1/2,53	2 870 1/2,44	3 980 1/2,5	5 360 1/2,55	7 130 1/2,43	9 290 1/2,53	12 950 1/2,53	16 080 1/2,44	20 100 1/2,44	22 820 1/2,5			
	2,24	-	-	-	-	-	1 480 1/2,28	1 960 1/2,3	2 840 1/2,21	3 880 1/2,24	5 310 1/2,2	7 240 1/2,27	9 400 1/2,33	12 860 1/2,3	16 280 1/2,26	20 350 1/2,26	22 700 1/2,29				
	2	-	-	-	-	-	1 500 1/2	-	2 870 1/1,95	-	5 370 1/2,05	-	9 270 1/2	-	16 070 1/1,95	20 080 1/1,95	-				
31 500 000	5	-	195 1/5	-	405 1/5,2	-	605 1/4,82	1 230 1/5	1 850 1/5	2 870 1/4,92	3 560 1/5,07	5 340 1/4,92	6 830 1/5,07	8 630 1/5,08	13 500 1/5	17 060 1/4,92	21 320 1/4,92	23 580 1/5,07			
	4,5	-	-	-	-	-	1 240 1/4,45	1 880 1/4,5	2 920 1/4,5	3 800 1/4,67	5 430 1/4,5	6 950 1/4,67	9 970 1/4,47	12 160 1/4,5	17 300 1/4,5	21 620 1/4,5	23 750 1/4,6				
	4	-	200 1/4	-	415 1/4,16	-	620 1/3,92	1 260 1/4	1 970 1/4,08	2 970 1/4,13	3 750 1/4,15	5 530 1/4,13	7 210 1/4,07	9 340 1/4	13 610 1/4,08	17 380 1/4,07	21 730 1/4,07	23 110 1/4			
	3,55	-	-	-	-	-	1 530 1/3,62	1 950 1/3,64	2 760 1/3,62	4 010 1/3,6	5 440 1/3,57	7 180 1/3,67	9 960 1/3,62	12 840 1/3,64	16 700 1/3,5	20 870 1/3,5	22 990 1/3,6				
	3,15	-	225 1/3,28	-	420 1/3,13	-	820 1/3,27	1 550 1/3,28	1 980 1/3,13	2 970 1/3,13	4 000 1/3,25	5 520 1/3,27	7 300 1/3,18	9 600 1/3,28	13 990 1/3,19	16 590 1/3,13	20 730 1/3,13	22 930 1/3,25			
	2,8	-	-	-	-	-	1 540 1/2,75	1 970 1/2,82	2 940 1/2,81	4 060 1/2,83	5 600 1/2,82	7 140 1/2,83	10 230 1/2,81	12 960 1/2,82	16 460 1/2,81	20 570 1/2,81	23 300 1/2,83				
	2,5	-	225 1/2,53	-	420 1/2,44	-	825 1/2,55	1 560 1/2,53	2 040 1/2,53	2 980 1/2,44	4 130 1/2,5	5 560 1/2,55	7 390 1/2,43	9 630 1/2,53	13 430 1/2,53	16 670 1/2,44	20 830 1/2,44	23 650 1/2,5			
	2,24	-	-	-	-	-	1 540 1/2,28	2 030 1/2,3	2 950 1/2,21	4 020 1/2,24	5 500 1/2,2	7 500 1/2,27	9 740 1/2,33	13 330 1/2,3	16 870 1/2,26	21 080 1/2,26	23 510 1/2,29				
	2	-	-	-	-	-	1 550 1/2	-	2 970 1/1,95	-	5 560 1/2,05	-	9 590 1/2	-	16 620 1/1,95	20 780 1/1,95	-				

For n_1 lower than 560 min⁻¹ see page 107.

7 - Selection tables (helical gear reducers)



$n_{N2} \cdot L_h$ min ⁻¹ · h	i_N	P_{N2} kW																i_N	n_1 min ⁻¹	n_{N2} min ⁻¹	
		M_{N2} N m																			
		50	63	64	80	81	100	125	140	160	180	200	225	250	280	320	321				360
28 000 000	6,3	99 21/6,42	185 21/6,53	220 21/6,86	390 21/6,41	445 21/6,41	810 21/6,42	1 630 21/6,53	–	3 260 21/6,41	–	7 470 21/6,42	–	14 970 21/6,53	–	25 380 21/6,41	29 970 21/6,41	–			
	5	–	205 1/5	–	420 1/5,2	–	625 1/4,82	1 270 1/5	1 910 1/5	2 970 1/4,92	3 680 1/5,07	5 510 1/4,92	7 050 1/5,07	8 920 1/5,08	13 950 1/5	17 630 1/4,92	22 040 1/4,92	24 370 1/5,07			
	4,5	–	–	–	–	–	–	1 290 1/4,45	1 940 1/4,5	3 020 1/4,5	3 930 1/4,67	5 610 1/4,5	7 190 1/4,67	10 320 1/4,47	12 580 1/4,5	17 900 1/4,5	22 370 1/4,5	24 570 1/4,6			
	4	–	210 1/4	–	430 1/4,16	–	640 1/3,92	1 300 1/4	2 030 1/4,08	3 070 1/4,13	3 870 1/4,15	5 700 1/4,13	7 440 1/4,07	9 650 1/4	14 040 1/4,08	17 940 1/4,07	22 420 1/4,07	23 850 1/4			
	3,55	–	–	–	–	–	–	1 590 1/3,62	2 020 1/3,64	2 860 1/3,62	4 160 1/3,6	5 630 1/3,57	7 440 1/3,67	10 320 1/3,62	13 300 1/3,64	17 300 1/3,5	21 620 1/3,5	23 820 1/3,6			
	3,15	–	230 1/3,28	–	435 1/3,13	–	850 1/3,27	1 610 1/3,28	2 060 1/3,13	3 070 1/3,13	4 150 1/3,25	5 720 1/3,27	7 560 1/3,18	9 950 1/3,28	14 500 1/3,19	17 190 1/3,13	21 490 1/3,13	23 770 1/3,25			
	2,8	–	–	–	–	–	–	1 590 1/2,75	2 040 1/2,82	3 050 1/2,81	4 210 1/2,83	5 800 1/2,82	7 400 1/2,83	10 610 1/2,81	13 440 1/2,82	17 060 1/2,81	21 320 1/2,81	24 150 1/2,83			
	2,5	–	230 1/2,53	–	435 1/2,44	–	855 1/2,55	1 610 1/2,53	2 120 1/2,53	3 090 1/2,44	4 280 1/2,5	5 760 1/2,55	7 660 1/2,43	9 980 1/2,53	13 910 1/2,53	17 260 1/2,44	21 580 1/2,44	24 500 1/2,5			
	2,24	–	–	–	–	–	–	1 590 1/2,28	2 100 1/2,3	3 050 1/2,21	4 160 1/2,24	5 690 1/2,2	7 760 1/2,27	10 080 1/2,33	13 790 1/2,3	17 450 1/2,26	21 810 1/2,26	24 330 1/2,29			
	2	–	–	–	–	–	–	1 600 1/2	–	3 070 1/1,95	–	5 740 1/2,05	–	9 900 1/2	–	17 160 1/1,95	21 450 1/1,95	–			
25 000 000	6,3	100 21/6,42	190 21/6,53	230 21/6,86	400 21/6,41	455 21/6,41	835 21/6,42	1 670 21/6,53	–	3 340 21/6,41	–	7 670 21/6,42	–	15 370 21/6,53	–	26 060 21/6,41	30 770 21/6,41	–			
	5	–	210 1/5	–	435 1/5,2	–	645 1/4,82	1 310 1/5	1 980 1/5	3 070 1/4,92	3 810 1/5,07	5 710 1/4,92	7 300 1/5,07	9 230 1/5,08	14 430 1/5	18 240 1/4,92	22 800 1/4,92	25 210 1/5,07			
	4,5	–	–	–	–	–	–	1 330 1/4,45	2 000 1/4,5	3 120 1/4,5	4 050 1/4,67	5 800 1/4,5	7 430 1/4,67	10 650 1/4,47	12 990 1/4,5	18 470 1/4,5	23 090 1/4,5	25 360 1/4,6			
	4	–	215 1/4	–	445 1/4,16	–	665 1/3,92	1 350 1/4	2 110 1/4,08	3 180 1/4,13	4 010 1/4,15	5 910 1/4,13	7 710 1/4,07	9 990 1/4	14 550 1/4,08	18 580 1/4,07	23 230 1/4,07	24 710 1/4			
	3,55	–	–	–	–	–	–	1 640 1/3,62	2 100 1/3,64	2 960 1/3,62	4 310 1/3,6	5 840 1/3,57	7 710 1/3,67	10 700 1/3,62	13 790 1/3,64	17 930 1/3,5	22 410 1/3,5	24 690 1/3,6			
	3,15	–	240 1/3,28	–	450 1/3,13	–	880 1/3,27	1 670 1/3,28	2 130 1/3,13	3 190 1/3,13	4 300 1/3,25	5 930 1/3,27	7 840 1/3,18	10 310 1/3,28	15 030 1/3,19	17 820 1/3,13	22 270 1/3,13	24 640 1/3,25			
	2,8	–	–	–	–	–	–	1 650 1/2,75	2 120 1/2,82	3 160 1/2,81	4 360 1/2,83	6 010 1/2,82	7 670 1/2,83	10 990 1/2,81	13 920 1/2,82	17 670 1/2,81	22 090 1/2,81	25 010 1/2,83			
	2,5	–	240 1/2,53	–	450 1/2,44	–	885 1/2,55	1 670 1/2,53	2 190 1/2,53	3 190 1/2,44	4 420 1/2,5	5 960 1/2,55	7 920 1/2,43	10 320 1/2,53	14 390 1/2,53	17 860 1/2,44	22 330 1/2,44	25 350 1/2,5			

For n_1 lower than 560 min⁻¹ see page 107.

7 - Selection tables (helical gear reducers)



$n_{N2} \cdot L_h$ min ⁻¹ · h	i_N	P_{N2} kW M_{N2} N m ... / i																i_N	n_1	n_{N2} min ⁻¹	
		50	63	64	80	81	100	125	140	160	180	200	225	250	280	320	321				360
25 000 000	2,24	-	-	-	-	-	-	1 640 1/2,28	2 160 1/2,3	3 150 1/2,21	4 290 1/2,24	5 880 1/2,2	8 010 1/2,27	10 400 1/2,33	14 230 1/2,3	18 010 1/2,26	22 510 1/2,26	25 110 1/2,29			
	2	-	-	-	-	-	-	1 660 1/2	-	3 180 1/1,95	-	5 950 1/2,05	-	10 250 1/2	-	17 770 1/1,95	22 220 1/1,95	-			
22 400 000	8	115 21/8,01	210 21/8,26	260 21/7,99	445 21/8,03	530 21/8,03	910 21/8,01	1 820 21/8,26	-	4 080 21/8,03	-	8 330 21/8,01	-	16 730 21/8,26	-	29 220 21/8,03	36 420 21/8,03	-			
	6,3	105 21/6,42	195 21/6,53	235 21/6,86	410 21/6,41	470 21/6,41	855 21/6,42	1 720 21/6,53	-	3 440 21/6,41	-	7 880 21/6,42	-	15 790 21/6,53	-	26 770 21/6,41	31 610 21/6,41	-			
	5	-	215 1/5	-	450 1/5,2	-	665 1/4,82	1 360 1/5	2 040 1/5	3 170 1/4,92	3 930 1/5,07	5 890 1/4,92	7 530 1/5,07	9 530 1/5,08	14 900 1/5	18 830 1/4,92	23 530 1/4,92	26 020 1/5,07			
	4,5	-	-	-	-	-	-	1 380 1/4,45	2 070 1/4,5	3 230 1/4,5	4 200 1/4,67	6 000 1/4,5	7 690 1/4,67	11 030 1/4,47	13 450 1/4,5	19 130 1/4,5	23 920 1/4,5	26 280 1/4,6			
	4	-	225 1/4	-	460 1/4,16	-	690 1/3,92	1 400 1/4	2 180 1/4,08	3 290 1/4,13	4 150 1/4,15	6 120 1/4,13	7 990 1/4,07	10 360 1/4	15 080 1/4,08	19 260 1/4,07	24 080 1/4,07	25 610 1/4			
	3,55	-	-	-	-	-	-	1 700 1/3,62	2 180 1/3,64	3 070 1/3,62	4 460 1/3,6	6 050 1/3,57	7 990 1/3,67	11 090 1/3,62	14 290 1/3,64	18 580 1/3,5	23 230 1/3,5	25 590 1/3,6			
	3,15	-	250 1/3,28	-	465 1/3,13	-	910 1/3,27	1 730 1/3,28	2 210 1/3,13	3 300 1/3,13	4 450 1/3,25	6 140 1/3,27	8 120 1/3,18	10 680 1/3,28	15 570 1/3,19	18 460 1/3,13	23 080 1/3,13	25 520 1/3,25			
	2,8	-	-	-	-	-	-	1 710 1/2,75	2 190 1/2,82	3 270 1/2,81	4 510 1/2,83	6 220 1/2,82	7 930 1/2,83	11 370 1/2,81	14 400 1/2,82	18 280 1/2,81	22 850 1/2,81	25 880 1/2,83			
	2,5	-	245 1/2,53	-	465 1/2,44	-	915 1/2,55	1 720 1/2,53	2 260 1/2,53	3 300 1/2,44	4 560 1/2,5	6 150 1/2,55	8 180 1/2,43	10 650 1/2,53	14 850 1/2,53	18 440 1/2,44	23 040 1/2,44	26 170 1/2,5			
	2,24	-	-	-	-	-	-	1 700 1/2,28	2 240 1/2,3	3 260 1/2,21	4 440 1/2,24	6 090 1/2,2	8 300 1/2,27	10 780 1/2,33	14 740 1/2,3	18 660 1/2,26	23 320 1/2,26	26 010 1/2,29			
	2	-	-	-	-	-	-	1 720 1/2	-	3 290 1/1,95	-	6 160 1/2,05	-	10 630 1/2	-	18 420 1/1,95	23 030 1/1,95	-			
20 000 000	9	-	-	-	-	-	-	2 360 21/9,22	4 090 21/9,24	4 730 21/9,31	8 330 21/8,85	10 590 21/8,88	16 730 21/9,19	21 670 21/9,22	29 220 21/9,24	36 420 21/9,24	43 500 21/9,31				
	8	115 21/8,01	215 21/8,26	270 21/7,99	455 21/8,03	545 21/8,03	930 21/8,01	1 870 21/8,26	-	4 190 21/8,03	-	8 550 21/8,01	-	17 170 21/8,26	-	29 990 21/8,03	37 390 21/8,03	-			
	6,3	105 21/6,42	200 21/6,53	240 21/6,86	425 21/6,41	480 21/6,41	880 21/6,42	1 760 21/6,53	-	3 520 21/6,41	-	8 080 21/6,42	-	16 190 21/6,53	-	27 450 21/6,41	32 410 21/6,41	-			
	5	-	220 1/5	-	465 1/5,2	-	690 1/4,82	1 410 1/5	2 110 1/5	3 280 1/4,92	4 070 1/5,07	6 100 1/4,92	7 800 1/5,07	9 870 1/5,08	15 430 1/5	19 500 1/4,92	24 380 1/4,92	26 960 1/5,07			
4,5	-	-	-	-	-	-	1 430 1/4,45	2 150 1/4,5	3 350 1/4,5	4 350 1/4,67	6 220 1/4,5	7 970 1/4,67	11 430 1/4,47	13 940 1/4,5	19 830 1/4,5	24 790 1/4,5	27 230 1/4,6				

For n_1 lower than 560 min⁻¹ see page 107.

7 - Selection tables (helical gear reducers)



$n_{N2} \cdot L_h$ min ⁻¹ · h	i_N	P_{N2} kW																i_N	n_1	n_{N2}	
		M_{N2} N m																			
		... / i																			
		50	63	64	80	81	100	125	140	160	180	200	225	250	280	320	321	360			
20 000 000	4	-	230 1/4	-	480 1/4,16	-	715 1/3,92	1 450 1/4	2 260 1/4,08	3 410 1/4,13	4 300 1/4,15	6 350 1/4,13	8 290 1/4,07	10 730 1/4	15 630 1/4,08	19 960 1/4,07	24 960 1/4,07	26 550 1/4			
	3,55	-	-	-	-	-	-	1 760 1/3,62	2 250 1/3,64	3 180 1/3,62	4 620 1/3,6	6 270 1/3,57	8 280 1/3,67	11 490 1/3,62	14 810 1/3,64	19 250 1/3,5	24 060 1/3,5	26 510 1/3,6			
	3,15	-	255 1/3,28	-	485 1/3,13	-	945 1/3,27	1 790 1/3,28	2 280 1/3,13	3 420 1/3,13	4 610 1/3,25	6 350 1/3,27	8 400 1/3,18	11 050 1/3,28	16 110 1/3,19	19 100 1/3,13	23 870 1/3,13	26 410 1/3,25			
	2,8	-	-	-	-	-	-	1 760 1/2,75	2 260 1/2,82	3 370 1/2,81	4 660 1/2,83	6 420 1/2,82	8 190 1/2,83	11 730 1/2,81	14 870 1/2,82	18 870 1/2,81	23 590 1/2,81	26 710 1/2,83			
	2,5	-	255 1/2,53	-	485 1/2,44	-	945 1/2,55	1 780 1/2,53	2 340 1/2,53	3 410 1/2,44	4 730 1/2,5	6 370 1/2,55	8 470 1/2,43	11 040 1/2,53	15 390 1/2,53	19 100 1/2,44	23 870 1/2,44	27 110 1/2,5			
	2,24	-	-	-	-	-	-	1 760 1/2,28	2 320 1/2,3	3 380 1/2,21	4 610 1/2,24	6 310 1/2,2	8 600 1/2,27	11 170 1/2,33	15 280 1/2,3	19 340 1/2,26	24 170 1/2,26	26 960 1/2,29			
	2	-	-	-	-	-	-	1 780 1/2	-	3 410 1/1,95	-	6 390 1/2,05	-	11 020 1/2	-	19 090 1/1,95	23 870 1/1,95	-			
18 000 000	10	115 21/10,2	210 21/10,7	265 21/11,2	465 21/10,3	550 21/10,3	910 21/10,2	1 820 21/10,7	2 610 21/10,2	4 090 21/10,3	5 420 21/10,7	8 330 21/10,2	11 660 21/9,95	16 730 21/10,7	23 030 21/10,4	29 220 21/10,3	36 420 21/10,3	46 070 21/10,7			
	9	-	-	-	-	-	-	-	2 420 21/9,22	4 200 21/9,24	4 850 21/9,31	8 550 21/8,85	10 870 21/8,88	17 170 21/9,19	22 250 21/9,22	29 990 21/9,24	37 390 21/9,24	44 650 21/9,31			
	8	120 21/8,01	220 21/8,26	275 21/7,99	470 21/8,03	560 21/8,03	960 21/8,01	1 920 21/8,26	-	4 300 21/8,03	-	8 780 21/8,01	-	17 640 21/8,26	-	30 810 21/8,03	38 410 21/8,03	-			
	6,3	110 21/6,42	205 21/6,53	245 21/6,86	435 21/6,41	495 21/6,41	905 21/6,42	1 810 21/6,53	-	3 620 21/6,41	-	8 310 21/6,42	-	16 660 21/6,53	-	28 230 21/6,41	33 340 21/6,41	-			
	5	-	225 1/5	-	480 1/5,2	-	715 1/4,82	1 460 1/5	2 190 1/5	3 400 1/4,92	4 220 1/5,07	6 320 1/4,92	8 090 1/5,07	10 230 1/5,08	16 000 1/5	20 210 1/4,92	25 270 1/4,92	27 940 1/5,07			
	4,5	-	-	-	-	-	-	1 480 1/4,45	2 230 1/4,5	3 470 1/4,5	4 510 1/4,67	6 450 1/4,5	8 260 1/4,67	11 850 1/4,47	14 450 1/4,5	20 560 1/4,5	25 690 1/4,5	28 230 1/4,6			
	4	-	240 1/4	-	495 1/4,16	-	740 1/3,92	1 500 1/4	2 340 1/4,08	3 530 1/4,13	4 460 1/4,15	6 580 1/4,13	8 580 1/4,07	11 120 1/4	16 190 1/4,08	20 680 1/4,07	25 850 1/4,07	27 500 1/4			
	3,55	-	-	-	-	-	-	1 830 1/3,62	2 330 1/3,64	3 290 1/3,62	4 780 1/3,6	6 480 1/3,57	8 570 1/3,67	11 880 1/3,62	15 320 1/3,64	19 920 1/3,5	24 900 1/3,5	27 430 1/3,6			
	3,15	-	265 1/3,28	-	500 1/3,13	-	975 1/3,27	1 840 1/3,28	2 360 1/3,13	3 520 1/3,13	4 750 1/3,25	6 560 1/3,27	8 670 1/3,18	11 410 1/3,28	16 620 1/3,19	19 710 1/3,13	24 640 1/3,13	27 250 1/3,25			
	2,8	-	-	-	-	-	-	1 830 1/2,75	2 340 1/2,82	3 500 1/2,81	4 830 1/2,83	6 650 1/2,82	8 480 1/2,83	12 160 1/2,81	15 400 1/2,82	19 550 1/2,81	24 430 1/2,81	27 670 1/2,83			
2,5	-	265 1/2,53	-	500 1/2,44	-	980 1/2,55	1 850 1/2,53	2 430 1/2,53	3 540 1/2,44	4 900 1/2,5	6 600 1/2,55	8 780 1/2,43	11 440 1/2,53	15 950 1/2,53	19 790 1/2,44	24 740 1/2,44	28 090 1/2,5				

For n_1 lower than 560 min⁻¹ see page 107.

7 - Selection tables (helical gear reducers)



$n_{N2} \cdot L_h$ min ⁻¹ · h	i_N	P_{N2} kW M_{N2} N m ... / i																i_N	n_1 min ⁻¹	n_{N2} min ⁻¹		
		50	63	64	80	81	100	125	140	160	180	200	225	250	280	320	321				360	
18 000 000	2,24	-	-	-	-	-	-	1 830 I/2,28	2 410 I/2,3	3 500 I/2,21	4 770 I/2,24	6 540 I/2,2	8 920 I/2,27	11 580 I/2,33	15 840 I/2,3	20 040 I/2,26	25 050 I/2,26	27 940 I/2,29				
	2	-	-	-	-	-	-	270 1 840 I/2 ▲	-	3 540 I/1,95	-	6 620 I/2,05	-	11 410 I/2	-	19 780 I/1,95	24 730 I/1,95	-	2	2800	1400	
16 000 000	11,2	-	-	-	-	-	-	2 750 2I/11,9	4 090 2I/11,9	5 840 2I/11,8	8 330 2I/11,2	11 660 2I/11,5	16 730 2I/11,8	23 030 2I/11,9	29 220 2I/11,5	36 420 2I/11,5	46 070 2I/11,8					
	10	115 2I/10,2	215 2I/10,7	270 2I/11,2	480 2I/10,3	565 2I/10,3	930 2I/10,2	1 870 2I/10,7	2 680 2I/10,2	4 200 2I/10,3	5 570 2I/10,7	8 550 2I/10,2	11 960 2I/9,95	17 170 2I/10,7	23 640 2I/10,4	29 990 2I/10,3	37 390 2I/10,3	47 290 2I/10,7				
	9	-	-	-	-	-	-	2 480 2I/9,22	4 310 2I/9,24	4 990 2I/9,31	8 780 2I/8,85	11 170 2I/8,88	17 640 2I/9,19	22 860 2I/9,22	30 810 2I/9,24	38 410 2I/9,24	45 870 2I/9,31					
	8	120 2I/8,01	225 2I/8,26	280 2I/7,99	480 2I/8,03	575 2I/8,03	980 2I/8,01	1 970 2I/8,26	-	4 410 2I/8,03	-	9 000 2I/8,01	-	18 090 2I/8,26	-	31 600 2I/8,03	39 390 2I/8,03	-				
	6,3	115 2I/6,42	215 2I/6,53	255 2I/6,86	450 2I/6,41	510 2I/6,41	935 2I/6,42	1 870 2I/6,53	-	3 740 2I/6,41	-	8 580 2I/6,42	-	17 190 2I/6,53	-	29 150 2I/6,41	34 420 2I/6,41	-				
	5	-	230 I/5	-	500 I/5,2	-	740 I/4,82	1 510 I/5	2 270 I/5	3 520 I/4,92	4 370 I/5,07	6 550 I/4,92	8 380 I/5,07	10 600 I/5,08	16 580 I/5	20 950 I/4,92	26 190 I/4,92	28 960 I/5,07				
	4,5	-	-	-	-	-	-	1 530 I/4,45	2 310 I/4,5	3 590 I/4,5	4 670 I/4,67	6 680 I/4,5	8 560 I/4,67	12 280 I/4,47	14 970 I/4,5	21 300 I/4,5	26 620 I/4,5	29 240 I/4,6				
	4	-	250 I/4	-	515 I/4,16	-	765 I/3,92	1 550 I/4	2 420 I/4,08	3 660 I/4,13	4 610 I/4,15	6 800 I/4,13	8 880 I/4,07	11 500 I/4	16 750 I/4,08	21 400 I/4,07	26 750 I/4,07	28 450 I/4				
	3,55	-	-	-	-	-	-	1 880 I/3,62	2 410 I/3,64	3 400 I/3,62	4 940 I/3,6	6 690 I/3,57	8 840 I/3,67	12 260 I/3,62	15 810 I/3,64	20 560 I/3,5	25 700 I/3,5	28 310 I/3,6				
	3,15	-	275 I/3,28	-	515 I/3,13	-	1 010 I/3,27	1 910 I/3,28	2 440 I/3,13	3 650 I/3,13	4 920 I/3,25	6 790 I/3,27	8 990 I/3,18	11 820 I/3,28	17 220 I/3,19	20 420 I/3,13	25 530 I/3,13	28 230 I/3,25				
	2,8	-	-	-	-	-	-	1 890 I/2,75	2 430 I/2,82	3 620 I/2,81	5 000 I/2,83	6 890 I/2,82	8 790 I/2,83	12 600 I/2,81	15 960 I/2,82	20 260 I/2,81	25 320 I/2,81	28 680 I/2,83				
	2,5	-	275 I/2,53	-	520 I/2,44	-	1 020 I/2,55	1 920 I/2,53	2 520 I/2,53	3 670 I/2,44	5 080 I/2,5	6 840 I/2,55	9 100 I/2,43	11 860 I/2,53	16 530 I/2,53	20 520 I/2,44	25 650 I/2,44	29 120 I/2,5				
	2,24	-	-	-	-	-	-	244 1 890 I/2,28	318 2 500 I/2,3 ▲	481 3 630 I/2,21 ▲	-	4 950 I/2,24	-	9 240 I/2,27	11 990 I/2,33	16 410 I/2,3	20 760 I/2,26	25 960 I/2,26	28 950 I/2,29	2,24	2800	1250
	2	-	-	-	-	-	-	244 1 870 I/2	-	491 3 660 I/1,95 ▲	-	6 850 I/2,05	-	11 810 I/2	-	20 460 I/1,95	25 580 I/1,95	-	2	2500		
14 000 000	12,5	110 2I/12,3	210 2I/13,1	260 2I/13,6	490 2I/13,7	580 2I/13,7	910 2I/12,3	1 820 2I/13,1	2 670 2I/13,3	4 020 2I/13,6	5 670 2I/13,6	8 120 2I/13	11 310 2I/12,8	16 280 2I/13,1	22 400 2I/13,3	28 330 2I/13,4	34 520 2I/13,4	44 850 2I/13,1				
	11,2	-	-	-	-	-	-	2 820 2I/11,9	4 200 2I/11,9	6 000 2I/11,8	8 550 2I/11,2	11 960 2I/11,5	17 170 2I/11,8	23 640 2I/11,9	29 990 2I/11,5	37 390 2I/11,5	47 290 2I/11,8					

For n_1 lower than 560 min⁻¹ see page 107.

▲ Possible forced lubrication with heat exchanger: consult us.

7 - Selection tables (helical gear reducers)



$n_{N2} \cdot L_h$ min ⁻¹ · h	i_N	P_{N2} kW M_{N2} N m ... / i																i_N	n_1 min ⁻¹	n_{N2} min ⁻¹	
		50	63	64	80	81	100	125	140	160	180	200	225	250	280	320	321				360
14 000 000	10	120 2/10,2	220 2/10,7	280 2/11,2	500 2/10,3	585 2/10,3	960 2/10,2	1 920 2/10,7	2 750 2/10,2	4 310 2/10,3	5 720 2/10,7	8 780 2/10,2	12 290 2/9,95	17 640 2/10,7	24 280 2/10,4	30 810 2/10,3	38 410 2/10,3	48 590 2/10,7			
	9	-	-	-	-	-	-	-	2 550 2/9,22	4 420 2/9,24	5 110 2/9,31	9 000 2/8,85	11 450 2/8,88	18 090 2/9,19	23 440 2/9,22	31 600 2/9,24	39 390 2/9,24	47 040 2/9,31			
	8	125 2/8,01	235 2/8,26	290 2/7,99	495 2/8,03	590 2/8,03	1 010 2/8,01	2 030 2/8,26	-	4 540 2/8,03	-	9 260 2/8,01	-	18 600 2/8,26	-	32 500 2/8,03	40 510 2/8,03	-			
	6,3	115 2/6,42	220 2/6,53	260 2/6,86	460 2/6,41	525 2/6,41	960 2/6,42	1 920 2/6,53	-	3 840 2/6,41	-	8 810 2/6,42	-	17 670 2/6,53	-	29 950 2/6,41	35 360 2/6,41	-			
	5	-	235 1/5	-	500 1/5,2	-	770 1/4,82	1 560 1/5	2 350 1/5	3 650 1/4,92	4 530 1/5,07	6 790 1/4,92	8 680 1/5,07	10 990 1/5,08	17 180 1/5	21 710 1/4,92	27 130 1/4,92	30 000 1/5,07			
	4,5	-	-	-	-	-	-	1 590 1/4,45	2 390 1/4,5	3 720 1/4,5	4 840 1/4,67	6 910 1/4,5	8 860 1/4,67	12 700 1/4,47	15 490 1/4,5	22 030 1/4,5	27 540 1/4,5	30 260 1/4,6			
	4	-	255 1/4	-	530 1/4,16	-	790 1/3,92	1 600 1/4	2 500 1/4,08	3 770 1/4,13	4 760 1/4,15	7 020 1/4,13	9 170 1/4,07	11 870 1/4	17 290 1/4,08	22 090 1/4,07	27 610 1/4,07	29 370 1/4			
	3,55	-	-	-	-	-	-	1 950 1/3,62	2 490 1/3,64	3 520 1/3,62	5 120 1/3,6	6 930 1/3,57	9 160 1/3,67	12 710 1/3,62	16 380 1/3,64	21 300 1/3,5	26 620 1/3,5	29 330 1/3,6			
	3,15	-	285 1/3,28	-	535 1/3,13	-	1 040 1/3,27	1 980 1/3,28	2 530 1/3,13	3 780 1/3,13	5 100 1/3,25	7 040 1/3,27	9 310 1/3,18	12 250 1/3,28	17 850 1/3,19	21 170 1/3,13	26 460 1/3,13	29 260 1/3,25			
	2,8	-	-	-	-	-	-	1 960 1/2,75	2 520 1/2,82	3 750 1/2,81	5 190 1/2,83	7 140 1/2,82	9 110 1/2,83	13 060 1/2,81	16 540 1/2,82	21 000 1/2,81	26 250 1/2,81	29 730 1/2,83			
	2,5	-	33 285 1/2,53	-	64,5 535 1/2,44	-	121 1 050 1/2,55	230 1 980 1/2,53	302 2 610 1/2,53	456 3 800 1/2,44 ▲	617 5 260 1/2,5 ▲	-	-	-	-	-	-	-	2,5	2800	1120
	2,24	-	-	-	-	-	-	225 1 960 1/2,28	294 2 580 1/2,3	444 3 750 1/2,21 ▲	598 5 120 1/2,24 ▲	-	-	-	-	-	-	-	2,24	2500	
	2	-	-	-	-	-	-	222 1 890 1/2	-	454 3 780 1/1,95 ▲	-	-	-	-	-	-	-	-	2	2240	
12 500 000	14	-	-	-	-	-	-	2 670 2/14,7	4 250 2/14,1	5 910 2/14,4	8 520 2/13,9	10 630 2/14,6	17 410 2/14,6	21 130 2/14,7	29 940 2/14,3	36 610 2/14,3	46 590 2/14,4				
	12,5	110 2/12,3	215 2/13,1	270 2/13,6	510 2/13,7	600 2/13,7	930 2/12,3	1 870 2/13,1	2 740 2/13,3	4 160 2/13,6	5 820 2/13,6	8 340 2/13	11 620 2/12,8	16 710 2/13,1	23 000 2/13,3	29 080 2/13,4	35 440 2/13,4	46 040 2/13,1			
	11,2	-	-	-	-	-	-	-	2 900 2/11,9	4 310 2/11,9	6 160 2/11,8	8 780 2/11,2	12 290 2/11,5	17 640 2/11,8	24 280 2/11,9	30 810 2/11,5	38 410 2/11,5	48 590 2/11,8			
	10	120 2/10,2	225 2/10,7	285 2/11,2	515 2/10,3	605 2/10,3	980 2/10,2	1 970 2/10,7	2 820 2/10,2	4 420 2/10,3	5 870 2/10,7	9 000 2/10,2	12 610 2/9,95	18 090 2/10,7	24 900 2/10,4	31 600 2/10,3	39 390 2/10,3	49 820 2/10,7			
	9	-	-	-	-	-	-	-	2 620 2/9,22	4 550 2/9,24	5 260 2/9,31	9 260 2/8,85	11 780 2/8,88	18 600 2/9,19	24 110 2/9,22	32 500 2/9,24	40 510 2/9,24	48 380 2/9,31			

For n_1 lower than 560 min⁻¹ see page 107.

▲ Possible forced lubrication with heat exchanger: consult us.

7 - Selection tables (helical gear reducers)



$n_{N2} \cdot L_h$ min ⁻¹ · h	i_N	P_{N2} kW M_{N2} N m ... / i																i_N	n_1 min ⁻¹	n_{N2} min ⁻¹	
		50	63	64	80	81	100	125	140	160	180	200	225	250	280	320	321				360
12 500 000	8	130 2/8,01	240 2/8,26	300 2/7,99	510 2/8,03	610 2/8,03	1 040 2/8,01	2 090 2/8,26	-	4 680 2/8,03	-	9 560 2/8,01	-	19 210 2/8,26	-	33 550 2/8,03	41 830 2/8,03	-			
	6,3	120 2/6,42	225 2/6,53	270 2/6,86	475 2/6,41	540 2/6,41	985 2/6,42	1 970 2/6,53	-	3 950 2/6,41	-	9 050 2/6,42	-	18 130 2/6,53	-	30 740 2/6,41	36 300 2/6,41	-			
	5	-	245 1/5	-	515 1/5,2	-	795 1/4,82	1 620 1/5	2 430 1/5	3 780 1/4,92	4 680 1/5,07	7 020 1/4,92	8 980 1/5,07	11 370 1/5,08	17 770 1/5	22 460 1/4,92	28 070 1/4,92	31 040 1/5,07			
	4,5	-	-	-	-	-	1 640 1/4,45	2 470 1/4,5	3 840 1/4,5	4 990 1/4,67	7 130 1/4,5	9 140 1/4,67	13 110 1/4,47	15 990 1/4,5	22 740 1/4,5	28 420 1/4,5	31 230 1/4,6				
	4	-	265 1/4	-	550 1/4,16	-	815 1/3,92	1 660 1/4	2 590 1/4,08	3 910 1/4,13	4 930 1/4,15	7 270 1/4,13	9 500 1/4,07	12 300 1/4	17 910 1/4,08	22 880 1/4,07	28 600 1/4,07	30 420 1/4			
	3,55	-	-	-	-	-	2 020 1/3,62	2 580 1/3,64	3 650 1/3,62	5 300 1/3,6	7 190 1/3,57	9 490 1/3,67	13 170 1/3,62	16 970 1/3,64	22 070 1/3,5	27 590 1/3,5	30 400 1/3,6				
	3,15	-	295 1/3,28	-	555 1/3,13	-	1 080 1/3,27	2 050 1/3,28	2 620 1/3,13	3 920 1/3,13	5 290 1/3,25	7 300 1/3,27	9 650 1/3,18	12 700 1/3,28	18 500 1/3,19	21 940 1/3,13	27 420 1/3,13	30 330 1/3,25			
	2,8	-	-	-	-	-	217 2 030	271 2 610	406 3 890	556 5 370	768 7 400	- 9 440	- 13 530	- 17 140	- 21 750	- 27 190	- 30 800		2,8	2800	1000
	2,5	-	30,5 295	-	59,6 555	-	111 1 090	213 2 050	279 2 700	421 3 930	570 5 450	751 7 330	- 9 750	- 12 710	- 17 720	- 21 990	- 27 490	- 31 210		2,5	2500
	2,24	-	-	-	-	-	208 2 020	272 2 670	411 3 880	554 5 290	772 7 240	- 9 880	- 12 820	- 17 540	- 22 200	- 27 750	- 30 950		2,24	2240	
2	-	-	-	-	-	201 1 920	- 3 820	410 1/1,95	- 7 320	749 1/2,05	- 12 620	- 21 880	- 27 350	- 31 040				2	2000		
11 200 000	16	120 2/16,3	215 2/15,8	285 2/16,5	525 2/15,7	620 2/15,7	930 2/16,1	1 860 2/15,8	2 750 2/15,1	4 490 2/15,7	5 740 2/16,6	8 520 2/16,1	11 240 2/15,6	17 090 2/16,2	21 910 2/15,7	29 940 2/15,9	37 290 2/15,9	45 340 2/16			
	14	-	-	-	-	-	-	2 740 2/14,7	4 400 2/14,1	6 070 2/14,4	8 750 2/13,9	10 920 2/14,6	18 020 2/14,6	21 690 2/14,7	30 730 2/14,3	37 580 2/14,3	47 830 2/14,4				
	12,5	115 2/12,3	220 2/13,1	280 2/13,6	525 2/13,7	620 2/13,7	960 2/12,3	1 920 2/13,1	2 820 2/13,3	4 290 2/13,6	5 980 2/13,6	8 560 2/13	11 930 2/12,8	17 170 2/13,1	23 630 2/13,3	29 880 2/13,4	36 410 2/13,4	47 300 2/13,1			
	11,2	-	-	-	-	-	-	2 970 2/11,9	4 420 2/11,9	6 320 2/11,8	9 000 2/11,2	12 610 2/11,5	18 090 2/11,8	24 900 2/11,9	31 600 2/11,5	39 390 2/11,5	49 820 2/11,8				
	10	125 2/10,2	235 2/10,7	295 2/11,2	530 2/10,3	625 2/10,3	1 010 2/10,2	2 030 2/10,7	2 900 2/10,2	4 550 2/10,3	6 030 2/10,7	9 260 2/10,2	12 960 2/9,95	18 600 2/10,7	25 610 2/10,4	32 500 2/10,3	40 510 2/10,3	51 240 2/10,7			
	9	-	-	-	-	-	-	-	2 710 2/9,22	4 700 2/9,24	5 430 2/9,31	9 560 2/8,85	12 160 2/8,88	19 210 2/9,19	24 890 2/9,22	33 550 2/9,24	41 830 2/9,24	49 950 2/9,31			
	8	135 2/8,01	250 2/8,26	310 2/7,99	525 2/8,03	625 2/8,03	1 070 2/8,01	2 150 2/8,26	-	4 810 2/8,03	-	9 820 2/8,01	-	19 730 2/8,26	-	34 470 2/8,03	42 970 2/8,03	-			

For n_1 lower than 560 min⁻¹ see page 107.

▲ Possible forced lubrication with heat exchanger: consult us.

7 - Selection tables (helical gear reducers)



$n_{N2} \cdot L_h$ min ⁻¹ · h	i_N	P_{N2} kW																	i_N	n_1	n_{N2} min ⁻¹	
		M_{N2} N m																				
		50	63	64	80	81	100	125	140	160	180	200	225	250	280	320	321	360				
11 200 000	6,3	125 21/6,42	230 21/6,53	275 21/6,86	485 21/6,41	555 21/6,41	1 010 21/6,42	2 030 21/6,53	–	4 050 21/6,41	–	9 300 21/6,42	–	18 630 21/6,53	–	31 580 21/6,41	37 290 21/6,41	–				
	5	–	245 1/5	–	515 1/5,2	–	820 1/4,82	1 670 1/5	2 510 1/5	3 900 1/4,92	4 830 1/5,07	7 250 1/4,92	9 270 1/5,07	11 730 1/5,08	18 340 1/5	23 180 1/4,92	28 970 1/4,92	32 030 1/5,07				
	4,5	–	–	–	–	–	–	1 690 1/4,45	2 550 1/4,5	3 970 1/4,5	5 170 1/4,67	7 390 1/4,5	9 470 1/4,67	13 580 1/4,47	16 560 1/4,5	23 560 1/4,5	29 450 1/4,5	32 350 1/4,6				
	4	–	275 1/4	–	570 1/4,16	–	845 1/3,92	1 720 1/4	2 690 1/4,08	4 050 1/4,13	5 110 1/4,15	7 540 1/4,13	9 840 1/4,07	12 750 1/4	18 560 1/4,08	23 710 1/4,07	29 640 1/4,07	31 530 1/4				
	3,55	–	–	–	–	–	–	2 100 1/3,62	2 680 1/3,64	3 780 1/3,62	5 500 1/3,6	7 450 1/3,57	9 840 1/3,67	13 650 1/3,62	17 590 1/3,64	22 880 1/3,5	28 600 1/3,5	31 510 1/3,6				
	3,15	–	26,8 300 1/3,28	–	53,8 575 1/3,13	–	101 1 120 1/3,27	190 2 130 1/3,28	255 2 720 1/3,13	380 4 060 1/3,13	494 5 480 1/3,25▲	678 7 560 1/3,27▲	–	10 000 13 150 1/3,18	–	19 170 22 730 1/3,19	–	28 410 31 420 1/3,13				31 420 1/3,25
	2,8	–	–	–	–	–	–	200 2 100 1/2,75	250 2 700 1/2,82	375 4 020 1/2,81	514 5 560 1/2,83▲	710 7 660 1/2,82▲	–	9 770 14 000 1/2,83	–	17 730 22 510 1/2,81	–	28 130 31 860 1/2,81				31 860 1/2,83
	2,5	–	28,2 305 1/2,53	–	55,1 575 1/2,44	–	103 1 120 1/2,55	197 2 120 1/2,53	259 2 790 1/2,53	390 4 060 1/2,44	528 5 630 1/2,5	696 7 580 1/2,55▲	974 10 080 1/2,43▲	–	–	18 310 22 730 1/2,53	–	28 410 32 260 1/2,44				32 260 1/2,5
	2,24	–	–	–	–	–	–	192 2 090 1/2,28	251 2 760 1/2,3	380 4 010 1/2,21	510 5 450 1/2,24	713 7 490 1/2,2▲	942 10 220 1/2,27▲	–	–	18 150 22 970 1/2,3	–	28 710 32 020 1/2,26				32 020 1/2,29
	2	–	–	–	–	–	–	183 1 940 1/2	–	369 3 820 1/1,95	–	695 7 550 1/2,05▲	–	–	13 030 – 1/2	–	22 580 – 1/1,95	–				28 230 – 1/1,95
10 000 000	18	–	–	–	–	–	–	2 820 21/17,6	4 310 21/18,1	5 780 21/18	8 520 21/17,6	11 960 21/18,1	17 090 21/17,8	23 570 21/17,9	29 940 21/17,8	37 290 21/17,8	46 850 21/18,3					
	16	120 21/16,3	225 21/15,8	290 21/16,5	545 21/15,7	640 21/15,7	955 21/16,1	1 910 21/15,8	2 830 21/15,1	4 640 21/15,7	5 890 21/16,6	8 750 21/16,1	11 530 21/15,6	17 550 21/16,2	22 490 21/15,7	30 730 21/15,9	38 280 21/15,9				46 540 21/16	
	14	–	–	–	–	–	–	–	2 820 21/14,7	4 540 21/14,1	6 230 21/14,4	8 990 21/13,9	11 220 21/14,6	18 620 21/14,6	22 280 21/14,7	31 580 21/14,3	38 610 21/14,3				49 140 21/14,4	
	12,5	120 21/12,3	225 21/13,1	290 21/13,6	545 21/13,7	640 21/13,7	980 21/12,3	1 970 21/13,1	2 890 21/13,3	4 440 21/13,6	6 140 21/13,6	8 780 21/13	12 240 21/12,8	17 600 21/13,1	24 230 21/13,3	30 640 21/13,4	37 340 21/13,4				48 500 21/13,1	
	11,2	–	–	–	–	–	–	–	3 060 21/11,9	4 550 21/11,9	6 500 21/11,8	9 260 21/11,2	12 960 21/11,5	18 600 21/11,8	25 610 21/11,9	32 500 21/11,5	40 510 21/11,5				51 240 21/11,8	
	10	130 21/10,2	240 21/10,7	305 21/11,2	550 21/10,3	650 21/10,3	1 040 21/10,2	2 090 21/10,7	2 990 21/10,2	4 700 21/10,3	6 230 21/10,7	9 560 21/10,2	13 380 21/9,95	19 210 21/10,7	26 440 21/10,4	33 550 21/10,3	41 830 21/10,3				52 900 21/10,7	
	9	–	–	–	–	–	–	–	2 780 21/9,22	4 830 21/9,24	5 580 21/9,31	9 820 21/8,85	12 490 21/8,88	19 730 21/9,19	25 570 21/9,22	34 470 21/9,24	42 970 21/9,24				51 320 21/9,31	
	8	135 21/8,01	255 21/8,26	315 21/7,99	540 21/8,03	645 21/8,03	1 100 21/8,01	2 200 21/8,26	–	4 940 21/8,03	–	10 080 21/8,01	–	20 260 21/8,26	–	35 390 21/8,03	44 110 21/8,03				–	

For n_1 lower than 560 min⁻¹ see page 107.

▲ Possible forced lubrication with heat exchanger: consult us.

7 - Selection tables (helical gear reducers)



$n_{N2} \cdot L_h$ min ⁻¹ · h	i_N	P_{N2} kW M_{N2} N m ... / i																i_N	n_1 min ⁻¹	n_{N2} min ⁻¹		
		50	63	64	80	81	100	125	140	160	180	200	225	250	280	320	321				360	
10 000 000	6,3	125 21/6,42	235 21/6,53	280 21/6,86	495 21/6,41	560 21/6,41	1 020 21/6,42	2 050 21/6,53	–	4 110 21/6,41	–	9 420 21/6,42	–	18 890 21/6,53	–	32 010 21/6,41	37 800 21/6,41	–				
	5	–	250 1/5	–	530 1/5,2	–	850 1/4,82	1 730 1/5	2 600 1/5	4 040 1/4,92	5 010 1/5,07	7 510 1/4,92	9 610 1/5,07	12 150 1/5,08	19 000 1/5	24 010 1/4,92	30 010 1/4,92	33 190 1/5,07				
	4,5	–	–	–	–	–	–	1 760 1/4,45	2 650 1/4,5	4 120 1/4,5	5 360 1/4,67	7 660 1/4,5	9 820 1/4,67	14 070 1/4,47	17 170 1/4,5	24 420 1/4,5	30 520 1/4,5	33 530 1/4,6				
	4	–	285 1/4	–	590 1/4,16	–	880 1/3,92	1 780 1/4	2 780 1/4,08	4 200 1/4,13	5 300 1/4,15	7 810 1/4,13	10 200 1/4,07	13 220 1/4	19 240 1/4,08	24 580 1/4,07	30 720 1/4,07	32 680 1/4				
	3,55	–	–	–	–	–	–	176 2 170 1/3,62	223 2 770 1/3,64	318 3 920 1/3,62	464 5 690 1/3,6	633 7 720 1/3,57▲	853 10 190 1/3,67	–	–	–	–	–	–	3,55	2800	800
	3,15	–	23,9 300 1/3,28	–	49,7 595 1/3,13	–	93 1 160 1/3,27	175 2 200 1/3,28	236 2 810 1/3,13	351 4 200 1/3,13	457 5 670 1/3,25	627 7 820 1/3,27▲	853 10 350 1/3,18▲	–	–	–	–	–	–	3,15	2500	
	2,8	–	–	–	–	–	–	185 2 170 1/2,75	232 2 790 1/2,82	347 4 160 1/2,81	476 5 740 1/2,83	657 7 910 1/2,82▲	836 10 090 1/2,83▲	–	–	–	–	–	–	2,8	2240	
	2,5	–	26,1 315 1/2,53	–	50,9 595 1/2,44	–	95,4 1 160 1/2,55	182 2 200 1/2,53	239 2 880 1/2,53	360 4 200 1/2,44	488 5 820 1/2,5	643 7 840 1/2,55	899 10 430 1/2,43▲	1 125 13 590 1/2,53▲	–	–	–	–	–	2,5	2000	
	2,24	–	–	–	–	–	–	179 2 160 1/2,28	234 2 850 1/2,3	353 4 140 1/2,21	459 5 450 1/2,24	663 7 730 1/2,2	875 10 550 1/2,27▲	1 106 13 690 1/2,33▲	–	–	–	–	–	2,24	1800	
	2	–	–	–	–	–	–	165 1 970 1/2	–	328 3 820 1/1,95	–	640 7 830 1/2,05	–	1 131 13 500 1/2▲	–	–	–	–	–	2	1600	
9 000 000	20	120 21/20,1	225 21/19,3	295 21/20,1	555 21/20,8	630 21/20,8	955 21/19,3	1 910 21/19,3	2 880 21/19,6	4 540 21/20,7	5 810 21/20,8	8 350 21/20,3	11 620 21/20	16 910 21/19,7	22 920 21/20,1	29 050 21/20,6	35 320 21/20,6	45 930 21/20,3				
	18	–	–	–	–	–	–	–	2 890 21/17,6	4 460 21/18,1	5 970 21/18	8 750 21/17,6	12 270 21/18,1	17 550 21/17,8	24 200 21/17,9	30 730 21/17,8	38 280 21/17,8	48 100 21/18,3				
	16	125 21/16,3	230 21/15,8	300 21/16,5	565 21/15,7	660 21/15,7	980 21/16,1	1 960 21/15,8	2 900 21/15,1	4 800 21/15,7	6 050 21/16,6	8 990 21/16,1	11 850 21/15,6	18 030 21/16,2	23 110 21/15,7	31 580 21/15,9	39 330 21/15,9	47 820 21/16				
	14	–	–	–	–	–	–	–	2 890 21/14,7	4 700 21/14,1	6 390 21/14,4	9 210 21/13,9	11 500 21/14,6	19 260 21/14,6	22 850 21/14,7	32 380 21/14,3	39 590 21/14,3	50 390 21/14,4				
	12,5	125 21/12,3	235 21/13,1	300 21/13,6	560 21/13,7	660 21/13,7	1 010 21/12,3	2 030 21/13,1	2 970 21/13,3	4 590 21/13,6	6 310 21/13,6	9 030 21/13	12 590 21/12,8	18 110 21/13,1	24 920 21/13,3	31 510 21/13,4	38 400 21/13,4	49 890 21/13,1				
	11,2	–	–	–	–	–	–	–	–	3 160 21/11,9	4 700 21/11,9	6 710 21/11,8	9 560 21/11,2	13 380 21/11,5	19 210 21/11,8	26 440 21/11,9	33 550 21/11,5	41 830 21/11,5	52 900 21/11,8			
	10	135 21/10,2	250 21/10,7	315 21/11,2	570 21/10,3	670 21/10,3	1 070 21/10,2	2 150 21/10,7	3 080 21/10,2	4 860 21/10,3	6 400 21/10,7	9 820 21/10,2	13 750 21/9,95	19 730 21/10,7	27 170 21/10,4	34 470 21/10,3	42 970 21/10,3	54 350 21/10,7				
9	–	–	–	–	–	–	–	–	2 850 21/9,22	4 950 21/9,24	5 730 21/9,31	10 080 21/8,85	12 830 21/8,88	20 260 21/9,19	26 250 21/9,22	35 390 21/9,24	44 110 21/9,24	52 680 21/9,31				

For n_1 lower than 560 min⁻¹ see page 107.

▲ Possible forced lubrication with heat exchanger: consult us.

7 - Selection tables (helical gear reducers)



$n_{N2} \cdot L_h$ min ⁻¹ · h	i_N	P_{N2} kW M_{N2} N m ... / i																i_N	n_1 min ⁻¹	n_{N2} min ⁻¹	
		50	63	64	80	81	100	125	140	160	180	200	225	250	280	320	321				360
9 000 000	8	140 2/8,01	260 2/8,26	325 2/7,99	555 2/8,03	660 2/8,03	1 130 2/8,01	2 270 2/8,26	–	5 080 2/8,03	–	10 360 2/8,01	–	20 810 2/8,26	–	36 360 2/8,03	45 320 2/8,03	–			
	6,3	125 2/6,42	240 2/6,53	285 2/6,86	500 2/6,41	570 2/6,41	1 040 2/6,42	2 080 2/6,53	–	4 160 2/6,41	–	9 540 2/6,42	–	19 120 2/6,53	–	32 420 2/6,41	38 280 2/6,41	–			
	5	–	250 1/5	–	530 1/5,2	–	880 1/4,82	1 790 1/5	2 700 1/5	4 190 1/4,92	5 190 1/5,07	7 780 1/4,92	9 960 1/5,07	12 590 1/5,08	19 690 1/5	24 890 1/4,92	31 110 1/4,92	34 400 1/5,07			
	4,5	–	–	–	–	–	–	1 820 1/4,45	2 740 1/4,5	4 270 1/4,5	5 550 1/4,67	7 940 1/4,5	10 170 1/4,67	14 590 1/4,47	17 790 1/4,5	25 310 1/4,5	31 630 1/4,5	34 750 1/4,6			
	4	–	21,7 295 1/4	–	43 610 1/4,16	–	68 910 1/3,92	135 1 850 1/4	207 2 880 1/4,08	309 4 350 1/4,13	388 5 490 1/4,15	574 8 090 1/4,13	–	–	–	–	–	–	4	2800	710
	3,55	–	–	–	–	–	–	163 2 250 1/3,62	206 2 870 1/3,64	294 4 060 1/3,62	428 5 890 1/3,6	585 7 980 1/3,57	753 10 550 1/3,67▲	–	–	–	–	–	3,55	2500	
	3,15	–	21,9 305 1/3,28	–	46 615 1/3,13	–	86,1 1 200 1/3,27	162 2 270 1/3,28	218 2 910 1/3,13	325 4 350 1/3,13	423 5 860 1/3,25	580 8 080 1/3,27	790 10 690 1/3,18▲	–	–	–	–	–	3,15	2240	
	2,8	–	–	–	–	–	–	171 2 250 1/2,75	214 2 890 1/2,82	320 4 300 1/2,81	439 5 940 1/2,83	607 8 190 1/2,82	772 10 440 1/2,83▲	1 114 14 970 1/2,81▲	1 406 18 960 1/2,82▲	–	–	–	2,8	2000	
	2,5	–	23,5 315 1/2,53	–	47,3 615 1/2,44	–	88,6 1 200 1/2,55	169 2 270 1/2,53	222 2 980 1/2,53	335 4 340 1/2,44	453 6 010 1/2,5	597 8 090 1/2,55	835 10 760 1/2,43	1 045 14 020 1/2,53▲	1 459 19 550 1/2,53▲	–	–	–	2,5	1800	
	2,24	–	–	–	–	–	–	165 2 240 1/2,28	215 2 950 1/2,3	325 4 290 1/2,21	408 5 450 1/2,24	610 8 010 1/2,2	806 10 930 1/2,27	1 019 14 190 1/2,33▲	1 413 19 400 1/2,3▲	–	–	–	2,24	1600	
	2	–	–	–	–	–	–	147 2 000 1/2	–	287 3 820 1/1,95	–	583 8 150 1/2,05	–	1 030 14 050 1/2▲	–	–	–	–	2	1400	
	8 000 000	22,4	–	–	–	–	–	–	2 930 2/21,7	4 600 2/22,5	6 010 2/23,3	8 470 2/22,2	10 930 2/23	19 520 2/22	21 600 2/22,2	27 390 2/22,8	34 270 2/22,8	43 280 2/23,4			
20		120 2/20,1	235 2/19,3	305 2/20,1	575 2/20,8	650 2/20,8	985 2/19,3	1 970 2/19,3	2 980 2/19,6	4 700 2/20,7	5 970 2/20,8	8 640 2/20,3	11 920 2/20	17 500 2/19,7	23 530 2/20,1	29 830 2/20,6	36 260 2/20,6	47 150 2/20,3			
18		–	–	–	–	–	–	2 970 2/17,6	4 610 2/18,1	6 170 2/18	8 990 2/17,6	12 610 2/18,1	18 030 2/17,8	24 860 2/17,9	31 580 2/17,8	39 330 2/17,8	49 420 2/18,3				
16		130 2/16,3	240 2/15,8	315 2/16,5	580 2/15,7	685 2/15,7	1 020 2/16,1	2 010 2/15,8	2 980 2/15,1	4 960 2/15,7	6 210 2/16,6	9 210 2/16,1	12 150 2/15,6	18 490 2/16,2	23 700 2/15,7	32 380 2/15,9	40 330 2/15,9	49 030 2/16			
14		–	–	–	–	–	–	2 990 2/14,7	4 850 2/14,1	6 570 2/14,4	9 480 2/13,9	11 830 2/14,6	19 880 2/14,6	23 500 2/14,7	33 300 2/14,3	40 720 2/14,3	51 820 2/14,4				
12,5		130 2/12,3	240 2/13,1	310 2/13,6	580 2/13,7	685 2/13,7	1 040 2/12,3	2 090 2/13,1	3 070 2/13,3	4 750 2/13,6	6 510 2/13,6	9 330 2/13	12 990 2/12,8	18 690 2/13,1	25 730 2/13,3	32 530 2/13,4	39 640 2/13,4	51 500 2/13,1			
11,2		–	–	–	–	–	–	3 250 2/11,9	4 830 2/11,9	6 890 2/11,8	9 820 2/11,2	13 750 2/11,5	19 730 2/11,8	27 170 2/11,9	34 470 2/11,5	42 970 2/11,5	54 350 2/11,8				

For n_1 lower than 560 min⁻¹ see page 107.

▲ Possible forced lubrication with heat exchanger: consult us.

7 - Selection tables (helical gear reducers)



$n_{N2} \cdot L_h$ min ⁻¹ · h	i_N	P_{N2} kW M_{N2} N m ... / i																i_N	n_1 min ⁻¹	n_{N2} min ⁻¹	
		50	63	64	80	81	100	125	140	160	180	200	225	250	280	320	321				360
		135 21/10,2	255 21/10,7	320 21/11,2	590 21/10,3	695 21/10,3	1 100 21/10,2	2 200 21/10,7	3 160 21/10,2	5 030 21/10,3	6 570 21/10,7	10 080 21/10,2	14 120 21/9,95	20 260 21/10,7	27 890 21/10,4	35 390 21/10,3	44 110 21/10,3				55 790 21/10,7
8 000 000	10	135 21/10,2	255 21/10,7	320 21/11,2	590 21/10,3	695 21/10,3	1 100 21/10,2	2 200 21/10,7	3 160 21/10,2	5 030 21/10,3	6 570 21/10,7	10 080 21/10,2	14 120 21/9,95	20 260 21/10,7	27 890 21/10,4	35 390 21/10,3	44 110 21/10,3	55 790 21/10,7			
	9	-	-	-	-	-	-	2 930 21/9,22	5 090 21/9,24	5 880 21/9,31	10 360 21/8,85	13 180 21/8,88	20 810 21/9,19	26 970 21/9,22	36 360 21/9,24	45 320 21/9,24	54 120 21/9,31				
	8	140 21/8,01	265 21/8,26	330 21/7,99	560 21/8,03	670 21/8,03	1 150 21/8,01	2 300 21/8,26	-	5 140 21/8,03	-	10 500 21/8,01	-	21 100 21/8,26	-	36 850 21/8,03	45 940 21/8,03	-			
	6,3	130 21/6,42	240 21/6,53	290 21/6,86	505 21/6,41	575 21/6,41	1 050 21/6,42	2 110 21/6,53	-	4 220 21/6,41	-	9 680 21/6,42	-	19 400 21/6,53	-	32 880 21/6,41	38 820 21/6,41	-			
	5	-	255 1/5	-	545 1/5,2	-	915 1/4,82	1 860 1/5	2 800 1/5	4 340 1/4,92	5 380 1/5,07	8 070 1/4,92	10 320 1/5,07	13 050 1/5,08	20 410 1/5	25 800 1/4,92	32 240 1/4,92	35 650 1/5,07			
	4,5	-	-	-	-	-	-	124 1 890 1/4,45	185 2 840 1/4,5	288 4 420 1/4,5	362 5 750 1/4,67	536 8 230 1/4,5	-	-	-	-	-	-	4,5	2800	630
	4	-	20 305 1/4	-	39,7 630 1/4,16	-	62,8 940 1/3,92	125 1 910 1/4	192 2 980 1/4,08	285 4 500 1/4,13	358 5 680 1/4,15	530 8 370 1/4,13	703 10 930 1/4,07	-	-	-	-	-	4	2500	
	3,55	-	-	-	-	-	-	151 2 320 1/3,62	191 2 970 1/3,64	272 4 190 1/3,62	397 6 090 1/3,6	542 8 250 1/3,57	697 10 900 1/3,67	-	-	-	-	-	3,55	2240	
	3,15	-	19,6 305 1/3,28	-	42,5 635 1/3,13	-	79,6 1 240 1/3,27	150 2 350 1/3,28	202 3 010 1/3,13	300 4 500 1/3,13	391 6 060 1/3,25	536 8 360 1/3,27	729 11 060 1/3,18	927 14 550 1/3,28▲	1 393 21 200 1/3,19▲	-	-	-	3,15	2000	
	2,8	-	-	-	-	-	-	159 2 320 1/2,75	199 2 980 1/2,82	298 4 440 1/2,81	408 6 130 1/2,83	564 8 450 1/2,82	717 10 780 1/2,83	1 035 15 450 1/2,81▲	1 306 19 570 1/2,82▲	-	-	-	2,8	1800	
	2,5	-	20,9 315 1/2,53	-	43,6 635 1/2,44	-	81,6 1 240 1/2,55	156 2 350 1/2,53	204 3 080 1/2,53	308 4 500 1/2,44	408 6 090 1/2,5	550 8 380 1/2,55	769 11 150 1/2,43	962 14 530 1/2,53	1 343 20 260 1/2,53▲	1 723 25 140 1/2,44▲	2 154 31 430 1/2,44▲	-	2,5	1600	
	2,24	-	-	-	-	-	-	150 2 330 1/2,28	196 3 070 1/2,3	287 4 330 1/2,21	357 5 450 1/2,24	556 8 340 1/2,27	734 11 370 1/2,27	928 14 760 1/2,33	1 287 20 200 1/2,3▲	1 656 25 560 1/2,26▲	2 070 31 950 1/2,26▲	-	2,24	1400	
2	-	-	-	-	-	-	133 2 030 1/2	-	256 3 820 1/1,95	-	527 8 250 1/2,05	-	951 14 540 1/2	-	1 689 25 190 1/1,95▲	2 111 31 490 1/1,95▲	-	2	1250		
7 100 000	25	105 21/24,4	225 21/24,1	270 21/25,1	475 21/26	545 21/26	985 21/23,7	1 970 21/24,1	2 900 21/24,1	4 250 21/24,6	5 800 21/25,4	8 590 21/24,2	11 010 21/25	17 350 21/25	21 850 21/24,6	24 970 21/25	34 840 21/25	39 870 21/25,7			
	22,4	-	-	-	-	-	-	3 030 21/21,7	4 760 21/22,5	6 220 21/23,3	8 760 21/22,2	11 250 21/23	19 500 21/22	22 180 21/22,2	28 120 21/22,8	35 450 21/22,8	44 430 21/23,4				
	20	125 21/20,1	240 21/19,3	315 21/20,1	580 21/20,8	685 21/20,8	1 020 21/19,3	2 040 21/19,3	3 080 21/19,6	4 860 21/20,7	6 130 21/20,8	8 930 21/20,3	12 250 21/20	18 080 21/19,7	24 170 21/20,1	30 640 21/20,6	37 250 21/20,6	48 440 21/20,3			
	18	-	-	-	-	-	-	3 060 21/17,6	4 770 21/18,1	6 390 21/18	9 210 21/17,6	12 930 21/18,1	18 540 21/17,8	25 490 21/17,9	32 380 21/17,8	40 330 21/17,8	50 670 21/18,3				
16	135 21/16,3	245 21/15,8	325 21/16,5	600 21/15,7	705 21/15,7	1 050 21/16,1	2 070 21/15,8	3 060 21/15,1	5 120 21/15,7	6 380 21/16,6	9 480 21/16,1	12 500 21/15,6	19 010 21/16,2	24 370 21/15,7	33 300 21/15,9	41 480 21/15,9	50 430 21/16				

For n_1 lower than 560 min⁻¹ see page 107.

▲ Possible forced lubrication with heat exchanger: consult us.

7 - Selection tables (helical gear reducers)

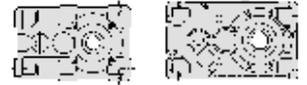

$n_{N2} \cdot L_h$ min ⁻¹ · h	i_N	P_{N2} kW																	i_N	n_1 min ⁻¹	n_{N2} min ⁻¹
		M_{N2} N m																			
		50	63	64	80	81	100	125	140	160	180	200	225	250	280	320	321	360			
7 100 000	14	-	-	-	-	-	-	-	3 090 2/14,7	5 030 2/14,1	6 790 2/14,4	9 780 2/13,9	12 210 2/14,6	20 600 2/14,6	24 260 2/14,7	34 380 2/14,3	42 040 2/14,3	53 500 2/14,4			
	12,5	135 2/12,3	250 2/13,1	320 2/13,6	580 2/13,7	685 2/13,7	1 070 2/12,3	2 150 2/13,1	3 150 2/13,3	4 920 2/13,6	6 690 2/13,6	9 580 2/13	13 350 2/12,8	19 200 2/13,1	26 430 2/13,3	33 430 2/13,4	40 730 2/13,4	52 910 2/13,1			
	11,2	-	-	-	-	-	-	-	3 330 2/11,9	4 950 2/11,9	7 080 2/11,8	10 080 2/11,2	14 120 2/11,5	20 260 2/11,8	27 890 2/11,9	35 390 2/11,5	44 110 2/11,5	55 790 2/11,8			
	10	140 2/10,2	260 2/10,7	330 2/11,2	615 2/10,3	720 2/10,3	1 130 2/10,2	2 270 2/10,7	3 240 2/10,2	5 210 2/10,3	6 750 2/10,7	10 360 2/10,2	14 500 2/9,95	20 810 2/10,7	28 650 2/10,4	36 360 2/10,3	45 320 2/10,3	57 320 2/10,7			
	9	-	-	-	-	-	-	-	2 970 2/9,22	5 160 2/9,24	5 960 2/9,31	10 500 2/8,85	13 360 2/8,88	21 100 2/9,19	27 330 2/9,22	36 850 2/9,24	45 940 2/9,24	54 860 2/9,31			
	8	145 2/8,01	270 2/8,26	335 2/7,99	575 2/8,03	680 2/8,03	1 160 2/8,01	2 330 2/8,26	-	5 210 2/8,03	-	10 630 2/8,01	-	21 360 2/8,26	-	37 320 2/8,03	46 520 2/8,03	-			
	6,3	130 2/6,42	245 2/6,53	290 2/6,86	515 2/6,41	585 2/6,41	1 070 2/6,42	2 140 2/6,53	-	4 280 2/6,41	-	9 810 2/6,42	-	19 670 2/6,53	-	33 350 2/6,41	39 380 2/6,41	-			
	5	-	15,1 255 1/5	-	31,6 560 1/5,2	-	57,5 945 1/4,82	113 1 930 1/5	170 2 900 1/5	268 4 490 1/4,92	322 5 570 1/5,07	498 8 360 1/4,92	-	612 10 690 1/5,07	-	1 500 21 150 1/5	26 720 33 400 1/4,92	36 930 1/5,07	5	2800	560
	4,5	-	-	-	-	-	-	115 1 950 1/4,45	171 2 940 1/4,5	266 4 580 1/4,5	334 5 950 1/4,67	495 8 510 1/4,5	612 10 900 1/4,67	-	1 500 19 070 1/4,5	-	27 120 33 910 1/4,5	37 250 1/4,6	4,5	2500	
	4	-	18 305 1/4	-	36,8 655 1/4,16	-	58,1 975 1/3,92	116 1 980 1/4	177 3 080 1/4,08	264 4 650 1/4,13	331 5 870 1/4,15	491 8 660 1/4,13	651 11 300 1/4,07	-	1 500 21 310 1/4,08	-	27 230 34 030 1/4,07	36 200 1/4	4	2240	
	3,55	-	-	-	-	-	-	139 2 400 1/3,62	176 3 070 1/3,64	251 4 340 1/3,62	366 6 300 1/3,6	501 8 540 1/3,57	644 11 280 1/3,67	906 15 640 1/3,62	1 159 20 160 1/3,64▲	-	32 770 1/3,5	36 110 1/3,6	3,55	2000	
	3,15	-	18,1 315 1/3,28	-	39,5 655 1/3,13	-	73,9 1 280 1/3,27	139 2 430 1/3,28	187 3 100 1/3,13	279 4 640 1/3,13	363 6 260 1/3,25	498 8 630 1/3,27	678 11 420 1/3,18	861 15 020 1/3,28	1 294 21 880 1/3,19▲	1 561 25 950 1/3,13▲	1 951 32 440 1/3,13▲	35 880 1/3,25	3,15	1800	
	2,8	-	-	-	-	-	-	146 2 400 1/2,75	183 3 080 1/2,82	274 4 600 1/2,81	376 6 350 1/2,83	519 8 750 1/2,82	660 11 170 1/2,83	953 16 000 1/2,81	1 203 20 270 1/2,82▲	1 533 25 730 1/2,81▲	1 916 32 160 1/2,81▲	36 430 1/2,83	2,8	1600	
	2,5	-	18,8 325 1/2,53	-	39,7 660 1/2,44	-	74,3 1 300 1/2,55	142 2 440 1/2,53	186 3 210 1/2,53	281 4 680 1/2,44	357 6 090 1/2,5	501 8 730 1/2,55	701 11 610 1/2,43	876 15 120 1/2,53	1 223 21 080 1/2,53	1 569 26 170 1/2,44▲	1 962 32 710 1/2,44▲	2 178 37 140 1/2,5▲	2,5	1400	
2,24	-	-	-	-	-	-	138 2 410 1/2,28	181 3 180 1/2,3	256 4 330 1/2,21	319 5 450 1/2,24	513 8 630 1/2,2	661 11 470 1/2,27	857 15 280 1/2,33	1 189 20 900 1/2,3	1 530 26 450 1/2,26▲	1 912 33 060 1/2,26▲	2 111 36 870 1/2,29▲	2,24	1250		
2	-	-	-	-	-	-	120 2 050 1/2	-	230 3 820 1/1,95	-	473 8 250 1/2,05	-	881 15 020 1/2	-	1 564 26 040 1/1,95▲	1 955 32 550 1/1,95▲	-	2	1120		
6 300 000	28	-	-	-	-	875 2/28,8	-	2 510 3/29,1	4 290 3/28,4	5 040 3/28,6	8 720 3/27,2	11 320 3/27,3	17 500 3/28,7	22 610 3/28,8	30 650 3/30	38 140 3/30	46 430 3/30,3				
	25	110 2/24,4	230 2/24,1	280 2/25,1	490 2/26	560 2/26	1 020 2/23,7	2 040 2/24,1	2 900 2/24,1	4 370 2/24,6	6 000 2/25,4	8 890 2/24,2	11 390 2/25	17 950 2/25	22 610 2/24,6	25 640 2/25	36 050 2/25	40 930 2/25,7			

For n_1 lower than 560 min⁻¹ see page 107.

▲ Possible forced lubrication with heat exchanger: consult us.

7 - Selection tables (helical gear reducers)



$n_{N2} \cdot L_h$ min ⁻¹ · h	i_N	P_{N2} kW																i_N	n_1	n_{N2} min ⁻¹		
		M_{N2} N m																				
		50	63	64	80	81	100	125	140	160	180	200	225	250	280	320	321				360	
6 300 000	22,4	-	-	-	-	-	-	-	3 140 21/21,7	4 920 21/22,5	6 430 21/23,3	9 060 21/22,2	11 630 21/23	20 000 21/22	22 780 21/22,2	28 890 21/22,8	36 640 21/22,8	45 640 21/23,4				
	20	130 21/20,1	250 21/19,3	325 21/20,1	585 21/20,8	685 21/20,8	1 060 21/19,3	2 110 21/19,3	3 180 21/19,6	5 020 21/20,7	6 290 21/20,8	9 240 21/20,3	12 560 21/20	18 710 21/19,7	24 790 21/20,1	31 420 21/20,6	38 200 21/20,6	49 680 21/20,3				
	18	-	-	-	-	-	-	-	3 160 21/17,6	4 930 21/18,1	6 590 21/18	9 480 21/17,6	13 300 21/18,1	19 140 21/17,8	26 220 21/17,9	33 300 21/17,8	41 480 21/17,8	52 120 21/18,3				
	16	140 21/16,3	255 21/15,8	335 21/16,5	625 21/15,7	735 21/15,7	1 090 21/16,1	2 140 21/15,8	3 160 21/15,1	5 310 21/15,7	6 590 21/16,6	9 780 21/16,1	12 900 21/15,6	19 630 21/16,2	25 160 21/15,7	34 380 21/15,9	42 820 21/15,9	52 060 21/16				
	14	-	-	-	-	-	-	-	3 210 21/14,7	5 210 21/14,1	6 970 21/14,4	10 050 21/13,9	12 550 21/14,6	21 350 21/14,6	24 930 21/14,7	35 320 21/14,3	43 190 21/14,3	54 970 21/14,4				
	12,5	140 21/12,3	255 21/13,1	330 21/13,6	585 21/13,7	690 21/13,7	1 100 21/12,3	2 200 21/13,1	3 260 21/13,3	5 100 21/13,6	6 870 21/13,6	9 840 21/13	13 700 21/12,8	19 710 21/13,1	27 130 21/13,3	34 310 21/13,4	41 810 21/13,4	54 320 21/13,1				
	11,2	-	-	-	-	-	-	-	3 420 21/11,9	5 090 21/11,9	7 270 21/11,8	10 360 21/11,2	14 500 21/11,5	20 810 21/11,8	28 650 21/11,9	36 360 21/11,5	45 320 21/11,5	57 320 21/11,8				
	10	140 21/10,2	265 21/10,7	345 21/11,2	635 21/10,3	745 21/10,3	1 150 21/10,2	2 300 21/10,7	3 290 21/10,2	5 390 21/10,3	6 840 21/10,7	10 500 21/10,2	14 700 21/9,95	21 100 21/10,7	29 040 21/10,4	36 850 21/10,3	45 940 21/10,3	58 100 21/10,7				
	9	-	-	-	-	-	-	-	3 010 21/9,22	5 220 21/9,24	6 040 21/9,31	10 630 21/8,85	13 530 21/8,88	21 360 21/9,19	27 680 21/9,22	37 320 21/9,24	46 520 21/9,24	55 550 21/9,31				
	8	145 21/8,01	270 21/8,26	340 21/7,99	595 21/8,03	700 21/8,03	1 180 21/8,01	2 360 21/8,26	-	5 280 21/8,03	-	10 780 21/8,01	-	21 670 21/8,26	-	37 850 21/8,03	47 180 21/8,03	-				
	6,3	130 21/6,42	250 21/6,53	295 21/6,86	520 21/6,41	600 21/6,41	1 080 21/6,42	2 170 21/6,53	-	4 340 21/6,41	-	9 960 21/6,42	-	19 960 21/6,53	-	33 830 21/6,41	39 950 21/6,41	-				
	5	-	13,9 265 1/5	-	28,3 560 1/5,2	-	53,2 980 1/4,82	104 1 990 1/5	157 3 000 1/5	247 4 650 1/4,92	298 5 770 1/5,07	460 8 650 1/4,92	571 11 060 1/5,07	-	-	-	-	38 210 1/5,07	5	2500	500	
	4,5	-	-	-	-	-	-	-	106 2 020 1/4,45	158 3 040 1/4,5	246 4 730 1/4,5	309 6 150 1/4,67	458 8 800 1/4,5	566 11 270 1/4,67	-	-	-	38 500 1/4,6	4,5	2240		
	4	-	16,1 305 1/4	-	32,7 650 1/4,16	-	53,7 1 010 1/3,92	107 2 040 1/4	164 3 190 1/4,08	244 4 810 1/4,13	306 6 070 1/4,15	454 8 950 1/4,13	601 11 690 1/4,07	793 15 140 1/4	1 133 22 050 1/4,08	-	-	37 460 1/4	4	2000		
	3,55	-	-	-	-	-	-	-	129 2 480 1/3,62	164 3 170 1/3,64	233 4 480 1/3,62	340 6 500 1/3,6	465 8 810 1/3,57	598 11 640 1/3,67	842 16 150 1/3,62	1 077 20 810 1/3,64	1 457 27 060 1/3,5▲	1 822 33 830 1/3,5▲	1 951 37 270 1/3,6▲	3,55	1800	
	3,15	-	16,1 315 1/3,28	-	36,4 680 1/3,13	-	68,1 1 330 1/3,27	128 2 510 1/3,28	172 3 220 1/3,13	257 4 810 1/3,13	334 6 480 1/3,25	459 8 940 1/3,27	624 11 830 1/3,18	793 15 560 1/3,28	1 192 22 670 1/3,19	1 437 26 880 1/3,13▲	1 797 33 600 1/3,13▲	1 916 37 170 1/3,25▲	3,15	1600		
2,8	-	-	-	-	-	-	-	133 2 500 1/2,75	167 3 210 1/2,82	250 4 790 1/2,81	342 6 610 1/2,83	473 9 110 1/2,82	601 11 620 1/2,83	868 16 660 1/2,81	1 096 21 100 1/2,82	1 396 26 780 1/2,81▲	1 745 33 480 1/2,81▲	1 962 37 910 1/2,83▲	2,8	1400		
2,5	-	16,8 325 1/2,53	-	36,7 685 1/2,44	-	67,5 1 320 1/2,55	131 2 530 1/2,53	172 3 320 1/2,53	254 4 750 1/2,44	319 6 090 1/2,5	462 9 030 1/2,55	647 12 010 1/2,43	810 15 650 1/2,53	1 130 21 810 1/2,53	1 450 27 070 1/2,44	1 812 33 840 1/2,44	2 012 38 430 1/2,5▲	2,5	1250			

For n_1 lower than 560 min⁻¹ see page 107.

▲ Possible forced lubrication with heat exchanger: consult us.

7 - Selection tables (helical gear reducers)



$n_{N2} \cdot L_h$ min ⁻¹ · h	i_N	P_{N2} kW																i_N	n_1 min ⁻¹	n_{N2} min ⁻¹	
		M_{N2} N m																			
		... / i																			
		50	63	64	80	81	100	125	140	160	180	200	225	250	280	320	321	360			
6 300 000	2,24	-	-	-	-	-	-	128 2 490 1/2,28	168 3 290 1/2,3	230 4 330 1/2,21	286 5 450 1/2,24	475 8 920 1/2,2	592 11 470 1/2,27	793 15 790 1/2,33	1 101 21 600 1/2,3	1 416 27 330 1/2,26	1 771 34 170 1/2,26	1 955 38 110 1/2,29 ▲	2,24	1120	500
	2	-	-	-	-	-	-	109 2 080 1/2	-	205 3 820 1/1,95	-	422 8 250 1/2,05	-	814 15 540 1/2	-	1 445 26 940 1/1,95	1 806 33 670 1/1,95	-	2	1000	
5 600 000	31,5	-	250 31/33,5	280 31/34,9	515 31/32,8	605 31/32,8	1 060 31/32,6	1 800 31/33,5	2 780 31/32,2	4 290 31/31,6	5 780 31/32,8	8 910 31/31,5	12 260 31/30,6	17 500 31/33,5	24 180 31/32,5	30 650 31/33,5	38 140 31/33,5	48 360 31/34,7			
	28	-	-	-	-	-	900 21/28,8	-	2 580 31/29,1	4 400 31/28,4	5 170 31/28,6	8 950 31/27,2	11 620 31/27,3	17 970 31/28,7	23 210 31/28,8	31 460 31/30	39 150 31/30	47 660 31/30,3			
	25	110 21/24,4	235 21/24,1	290 21/25,1	495 21/26	580 21/26	1 050 21/23,7	2 110 21/24,1	3 000 21/24,1	4 500 21/24,6	6 200 21/25,4	9 180 21/24,2	11 770 21/25	18 550 21/25	23 370 21/24,6	26 340 21/25	37 260 21/25	42 050 21/25,7			
	22,4	-	-	-	-	-	-	-	3 240 21/21,7	5 090 21/22,5	6 650 21/23,3	9 370 21/22,2	12 030 21/23	20 600 21/22	23 360 21/22,2	29 630 21/22,8	37 910 21/22,8	46 810 21/23,4			
	20	130 21/20,1	255 21/19,3	335 21/20,1	585 21/20,8	690 21/20,8	1 090 21/19,3	2 180 21/19,3	3 290 21/19,6	5 180 21/20,7	6 470 21/20,8	9 540 21/20,3	12 920 21/20	19 310 21/19,7	25 490 21/20,1	32 320 21/20,6	39 290 21/20,6	51 090 21/20,3			
	18	-	-	-	-	-	-	-	3 270 21/17,6	5 100 21/18,1	6 830 21/18	9 780 21/17,6	13 730 21/18,1	19 830 21/17,8	27 070 21/17,9	34 380 21/17,8	42 820 21/17,8	53 810 21/18,3			
	16	145 21/16,3	265 21/15,8	345 21/16,5	645 21/15,7	760 21/15,7	1 130 21/16,1	2 190 21/15,8	3 250 21/15,1	5 500 21/15,7	6 770 21/16,6	10 050 21/16,1	13 260 21/15,6	20 170 21/16,2	25 850 21/15,7	35 320 21/15,9	43 990 21/15,9	53 490 21/16			
	14	-	-	-	-	-	-	-	3 320 21/14,7	5 400 21/14,1	7 160 21/14,4	10 320 21/13,9	12 880 21/14,6	22 130 21/14,6	25 590 21/14,7	36 260 21/14,3	44 330 21/14,3	56 430 21/14,4			
	12,5	145 21/12,3	265 21/13,1	345 21/13,6	585 21/13,7	690 21/13,7	1 130 21/12,3	2 270 21/13,1	3 370 21/13,3	5 290 21/13,6	7 060 21/13,6	10 100 21/13	14 080 21/12,8	20 250 21/13,1	27 880 21/13,3	35 250 21/13,4	42 960 21/13,4	55 800 21/13,1			
	11,2	-	-	-	-	-	-	-	3 470 21/11,9	5 180 21/11,9	7 370 21/11,8	10 500 21/11,2	14 700 21/11,5	21 100 21/11,8	29 040 21/11,9	36 850 21/11,5	45 940 21/11,5	58 100 21/11,8			
	10	145 21/10,2	270 21/10,7	355 21/11,2	655 21/10,3	770 21/10,3	1 160 21/10,2	2 330 21/10,7	3 330 21/10,2	5 570 21/10,3	6 930 21/10,7	10 630 21/10,2	14 890 21/9,95	21 360 21/10,7	29 410 21/10,4	37 320 21/10,3	46 520 21/10,3	58 840 21/10,7			
	9	-	-	-	-	-	-	-	3 050 21/9,22	5 300 21/9,24	6 120 21/9,31	10 780 21/8,85	13 720 21/8,88	21 670 21/9,19	28 070 21/9,22	37 850 21/9,24	47 180 21/9,24	56 340 21/9,31			
	8	150 21/8,01	275 21/8,26	345 21/7,99	620 21/8,03	725 21/8,03	1 190 21/8,01	2 390 21/8,26	-	5 360 21/8,03	-	10 940 21/8,01	-	21 980 21/8,26	-	38 390 21/8,03	47 860 21/8,03	-			
	6,3	6,12	11,3	12,8	24,2	28,5	50,7	98,7	-	201	-	461	-	908	-	-	-	-	6,3	2800	450
		135 21/6,42	250 21/6,53	300 21/6,86	530 21/6,41	625 21/6,41	1 110 21/6,42	2 200 21/6,53	-	4 400 21/6,41	-	10 100 21/6,42	-	20 240 21/6,53 ▲	-	34 310 21/6,41	40 510 21/6,41	-			
	5	-	12,4 265 1/5	-	25,4 565 1/5,2	-	49,2 1 010 1/4,82	96,6 2 060 1/5	145 3 100 1/5	229 4 810 1/4,92	276 5 960 1/5,07	426 8 940 1/4,92	529 11 430 1/5,07	-	-	-	-	-	5	2240	
4,5	-	-	-	-	-	-	98,1 2 090 1/4,45	146 3 140 1/4,5	228 4 890 1/4,5	286 6 370 1/4,67	423 9 100 1/4,5	523 11 660 1/4,67	784 16 720 1/4,47	949 20 390 1/4,5	-	-	-	4,5	2000		

For n_1 lower than 560 min⁻¹ see page 107.

▲ Possible forced lubrication with heat exchanger: consult us.

7 - Selection tables (helical gear reducers)



$n_{N2} \cdot L_h$ min ⁻¹ · h	i_N	P_{N2} kW M_{N2} N m ... / i																i_N	n_1 min ⁻¹	n_{N2} min ⁻¹	
		50	63	64	80	81	100	125	140	160	180	200	225	250	280	320	321				360
5 600 000	4	-	14,8 315 1/4	-	30,3 670 1/4,16	-	49,9 1 040 1/3,92	99,4 2 110 1/4	152 3 290 1/4,08	227 4 970 1/4,13	284 6 270 1/4,15	421 9 240 1/4,13	559 12 070 1/4,07	737 15 630 1/4	1 052 22 760 1/4,08	1 347 29 070 1/4,07	1 684 36 340 1/4,07	1 822 38 660 1/4▲	4	1800	450
	3,55	-	-	-	-	-	119 2 570 1/3,62	151 3 280 1/3,64	215 4 640 1/3,62	313 6 730 1/3,6	428 9 130 1/3,57	551 12 060 1/3,67	775 16 730 1/3,62	992 21 560 1/3,64	1 342 28 030 1/3,5	1 677 35 040 1/3,5	1 797 38 610 1/3,6▲	3,55	1600		
	3,15	-	14,5 325 1/3,28	-	32,3 690 1/3,13	-	62 1 380 1/3,27	117 2 620 1/3,28	157 3 350 1/3,13	234 5 000 1/3,13	304 6 750 1/3,25	418 9 310 1/3,27	568 12 310 1/3,18	722 16 190 1/3,28	1 085 23 600 1/3,19	1 309 27 980 1/3,13	1 636 34 980 1/3,13	1 745 38 690 1/3,25▲	3,15	1400	
	2,8	-	-	-	-	-	123 2 590 1/2,75	154 3 320 1/2,82	231 4 950 1/2,81	316 6 840 1/2,83	437 9 430 1/2,82	556 12 030 1/2,83	802 17 230 1/2,81	1 012 21 830 1/2,82	1 290 27 710 1/2,81	1 612 34 640 1/2,81	1 812 39 230 1/2,83▲	2,8	1250		
	2,5	-	15,1 325 1/2,53	-	33,9 710 1/2,44	-	60,5 1 320 1/2,55	121 2 610 1/2,53	159 3 430 1/2,53	228 4 750 1/2,44	286 6 090 1/2,5	428 9 330 1/2,55	589 12 200 1/2,43	750 16 170 1/2,53	1 047 22 540 1/2,53	1 342 27 980 1/2,44	1 678 34 980 1/2,44	1 863 39 710 1/2,5	2,5	1120	
	2,24	-	-	-	-	-	118 2 580 1/2,28	155 3 400 1/2,3	205 4 330 1/2,21	255 5 450 1/2,24	425 8 930 1/2,2	529 11 470 1/2,27	733 16 330 1/2,33	1 017 22 340 1/2,3	1 308 28 280 1/2,26	1 636 35 350 1/2,26	1 806 39 420 1/2,29	2,24	1000		
	2	-	-	-	-	-	99,3 2 110 1/2	-	185 3 820 1/1,95	-	380 8 250 1/2,05	-	756 16 040 1/2	-	1 342 27 800 1/1,95	1 678 34 760 1/1,95	-	2	900		
	5 000 000	35,5	-	-	-	-	-	-	2 890 31/37,5	4 870 31/36,5	6 130 31/36,3	9 750 31/34,4	12 260 31/35,4	17 660 31/36,9	24 180 31/37,2	30 650 31/37,4	38 140 31/37,4	48 360 31/38,4			
31,5		-	255 31/33,5	290 31/34,9	530 31/32,8	625 31/32,8	1 090 31/32,6	1 850 31/33,5	2 860 31/32,2	4 400 31/31,6	5 930 31/32,8	9 220 31/31,5	12 580 31/30,6	17 970 31/33,5	24 820 31/32,5	31 460 31/33,5	39 150 31/33,5	49 640 31/34,7			
28		-	-	-	-	925 21/28,8	-	2 650 31/29,1	4 530 31/28,4	5 310 31/28,6	9 190 31/27,2	11 930 31/27,3	18 460 31/28,7	23 850 31/30	32 320 31/30	40 230 31/30	48 970 31/30,3				
25		110 21/24,4	245 21/24,1	300 21/25,1	495 31/26	585 21/26	1 090 21/23,7	2 120 21/24,1	3 070 21/24,1	4 620 21/24,6	6 410 21/25,4	9 500 21/24,2	12 180 21/25	19 190 21/25	24 170 21/24,6	27 010 21/25	38 540 21/25	43 120 21/25,7			
22,4		-	-	-	-	-	-	3 350 21/21,7	5 260 21/22,5	6 860 21/23,3	9 670 21/22,2	12 410 21/23	21 200 21/22	24 030 21/22,2	30 470 21/22,8	39 120 21/22,8	48 140 21/23,4				
20		135 21/20,1	265 21/19,3	345 21/20,1	590 21/20,8	690 21/20,8	1 130 21/19,3	2 250 21/19,3	3 400 21/19,6	5 370 21/20,7	6 670 21/20,8	9 880 21/20,3	13 340 21/20	20 000 21/19,7	26 320 21/20,1	33 360 21/20,6	40 560 21/20,6	52 740 21/20,3			
18		-	-	-	-	-	-	3 390 21/17,6	5 290 21/18,1	7 080 21/18	10 050 21/17,6	14 110 21/18,1	20 550 21/17,8	27 810 21/17,9	35 320 21/17,8	43 990 21/17,8	55 280 21/18,3				
16		150 21/16,3	275 21/15,8	360 21/16,5	670 21/15,7	785 21/15,7	1 170 21/16,1	2 250 21/15,8	3 330 21/15,1	5 700 21/15,7	6 950 21/16,6	10 320 21/16,1	13 610 21/15,6	20 700 21/16,2	26 540 21/15,7	36 260 21/15,9	45 160 21/15,9	54 910 21/16			
14		-	-	-	-	-	-	3 440 21/14,7	5 600 21/14,1	7 350 21/14,4	10 600 21/13,9	13 230 21/14,6	22 410 21/14,6	26 290 21/14,7	37 250 21/14,3	45 550 21/14,3	57 970 21/14,4				
12,5		150 21/12,3	275 21/13,1	355 21/13,6	590 21/13,7	695 21/13,7	1 150 21/12,3	2 320 21/13,1	3 490 21/13,3	5 470 21/13,6	7 160 21/13,6	10 240 21/13	14 270 21/12,8	20 540 21/13,1	28 260 21/13,3	35 730 21/13,4	43 540 21/13,4	56 560 21/13,1			
11,2	-	-	-	-	-	-	3 510 21/11,9	5 350 21/11,9	7 460 21/11,8	10 630 21/11,2	14 890 21/11,5	21 360 21/11,8	29 410 21/11,9	37 320 21/11,5	46 520 21/11,5	58 840 21/11,8					

For n_1 lower than 560 min⁻¹ see page 107.

▲ Possible forced lubrication with heat exchanger: consult us.

7 - Selection tables (helical gear reducers)



$n_{N2} \cdot L_h$ min ⁻¹ · h	i_N	P_{N2} kW M_{N2} N m ... / i																i_N	n_1 min ⁻¹	n_{N2} min ⁻¹	
		50	63	64	80	81	100	125	140	160	180	200	225	250	280	320	321				360
		150 21/10,2	280 21/10,7	365 21/11,2	680 21/10,3	800 21/10,3	1 180 21/10,2	2 370 21/10,7	3 380 21/10,2	5 770 21/10,3	7 140 21/10,7	10 780 21/10,2	15 100 21/9,95	21 670 21/10,7	29 830 21/10,4	37 850 21/10,3	47 180 21/10,3				59 670 21/10,7
5 000 000	10																				
	9	-	-	-	-	-	-	-	3 100 21/9,22	5 370 21/9,24	6 210 21/9,31	10 940 21/8,85	13 910 21/8,88	21 980 21/9,19	28 480 21/9,22	38 390 21/9,24	47 860 21/9,24	57 150 21/9,31			
	8	150 21/8,01	280 21/8,26	350 21/7,99	640 21/8,03	755 21/8,03	1 210 21/8,01	2 430 21/8,26	-	5 440 21/8,03	-	11 100 21/8,01	-	22 290 21/8,26	-	38 940 21/8,03	48 540 21/8,03	-			
	6,3	5,54 21/6,42	10,2 21/6,53	11,8 21/6,86	22,4 21/6,41	26,3 21/6,41	46,9 21/6,42	89,4 21/6,53	-	182 21/6,41	-	418 21/6,42	-	822 21/6,53▲	-	34 780 21/6,41	41 060 21/6,41	-	6,3	2500	400
	5	-	11,4 1/5	-	22,8 1/5,2	-	45,5 1/4,82	89,2 2 130	134 1/5	211 1/4,92	255 1/5,07	393 1/4,92	488 1/5,07	617 1/5,08	980 1/5	29 560 1/4,92	36 950 1/4,92	40 860 1/5,07	5	2000	
	4,5	-	-	-	-	-	91,1 2 150	136 1/4,45	212 1/4,5	265 1/4,5	393 1/4,67	486 1/4,5	728 1/4,47	882 1/4,5	1 254 1/4,5	1 567 1/4,5	1 684 1/4,6▲	4,5	1800		
	4	-	13,2 1/4	-	26,9 1/4,16	-	45,9 1/3,92	91,5 2 180	140 1/4,08	209 1/4,13	262 1/4,15	388 1/4,13	514 1/4,07	678 1/4	969 1/4,08	1 241 1/4,07	1 551 1/4,07	1 677 1/4	4	1600	
	3,55	-	-	-	-	-	108 2 680	137 1/3,62	196 1/3,64	285 1/3,62	390 1/3,6	502 1/3,57	706 1/3,67	903 1/3,62	1 222 1/3,64	1 528 1/3,5	1 636 1/3,5	3,55	1400		
	3,15	-	12,9 1/3,28	-	28,8 1/3,13	-	56,1 1/3,27	108 2 710	145 1/3,13	216 1/3,13	281 1/3,25	386 1/3,27	525 1/3,18	667 1/3,28	1 003 1/3,19	1 209 1/3,13	1 512 1/3,13	1 612 1/3,25	3,15	1250	
	2,8	-	-	-	-	-	114 2 670	143 1/2,75	214 1/2,82	286 1/2,81	405 1/2,83	514 1/2,82	743 1/2,81	937 1/2,82	1 194 1/2,81	1 493 1/2,81	1 678 1/2,81	2,8	1120		
	2,5	-	13,9 1/2,53	-	30,4 1/2,44	-	54 1/2,55	112 2 700	147 1/2,53	203 1/2,44	255 1/2,5	396 1/2,55	526 1/2,43	693 1/2,53	967 1/2,53	1 240 1/2,44	1 550 1/2,44	1 721 1/2,5	2,5	1000	
	2,24	-	-	-	-	-	110 2 660	144 1/2,28	185 1/2,21	229 1/2,24	382 1/2,27	476 1/2,23	681 1/2,33	945 1/2,3	1 215 1/2,26	1 519 1/2,26	1 678 1/2,29	2,24	900		
2	-	-	-	-	-	89,5 2 140	-	164 1/1,95	338 1/1,95	438 1/2,05	620 1/2,05	820 1/2,05	1 060 1/2	1 360 1/1,95	1 720 1/1,95	2 140 1/1,95	2	800			
4 500 000	40	-	265 31/40,8	325 31/42,5	560 31/43,6	650 31/43,6	1 150 31/39,1	2 030 31/40,8	2 890 31/38,7	5 140 31/38,5	5 930 31/39,9	10 600 31/41,5	12 520 31/40,4	18 030 31/42,4	24 180 31/41,2	30 650 31/40,7	38 140 31/42,3				
	35,5	-	-	-	-	-	-	2 970 31/37,5	5 040 31/36,5	6 290 31/36,3	10 080 31/34,4	12 580 31/35,4	18 280 31/36,9	24 820 31/37,2	31 460 31/37,4	39 150 31/37,4	49 640 31/38,4				
	31,5	-	265 31/33,5	290 31/34,9	550 31/32,8	645 31/32,8	1 130 31/32,6	1 900 31/33,5	2 930 31/32,2	4 530 31/31,6	6 090 31/32,8	9 530 31/31,5	12 930 31/30,6	18 460 31/33,5	25 500 31/32,5	32 320 31/33,5	40 230 31/33,5	51 000 31/34,7			
	28	-	-	-	-	950 21/28,8	-	2 720 31/29,1	4 640 31/28,4	5 450 31/28,6	9 430 31/27,2	12 240 31/27,3	18 930 31/28,7	24 460 31/28,8	33 150 31/30	41 250 31/30	50 210 31/30,3				
	25	120 21/24,4	250 21/24,1	305 21/25,1	495 21/26	585 21/26	1 120 21/23,7	2 180 21/24,1	3 150 21/24,1	4 750 21/24,6	6 620 21/25,4	9 810 21/24,2	12 570 21/25	19 810 21/25	24 950 21/24,6	27 780 21/25	39 780 21/25	44 350 21/25,7			

For n_1 lower than 560 min⁻¹ see page 107.

▲ Possible forced lubrication with heat exchanger: consult us.

7 - Selection tables (helical gear reducers)



$n_{N2} \cdot L_h$ min ⁻¹ · h	i_N	P_{N2} kW																i_N	n_1	n_{N2}	
		M_{N2} N m																			
		...																			
		$/i$																			
		50	63	64	80	81	100	125	140	160	180	200	225	250	280	320	321	360			
4 500 000	22,4	-	-	-	-	-	-	-	3 470 21/21,7	5 440 21/22,5	7 110 21/23,3	10 020 21/22,2	12 860 21/23	22 450 21/22	24 810 21/22,2	31 460 21/22,8	40 530 21/22,8	49 700 21/23,4			
	20	140 21/20,1	275 21/19,3	360 21/20,1	590 21/20,8	695 21/20,8	1 170 21/19,3	2 340 21/19,3	3 530 21/19,6	5 570 21/20,7	6 860 21/20,8	10 240 21/20,3	13 700 21/20	20 730 21/19,7	27 040 21/20,1	34 280 21/20,6	41 670 21/20,6	54 190 21/20,3			
	18	-	-	-	-	-	-	-	3 510 21/17,6	5 480 21/18,1	7 340 21/18	10 320 21/17,6	14 480 21/18,1	21 300 21/17,8	28 550 21/17,9	36 260 21/17,8	45 160 21/17,8	56 750 21/18,3			
	16	155 21/16,3	285 21/15,8	370 21/16,5	695 21/15,7	815 21/15,7	1 210 21/16,1	2 310 21/15,8	3 430 21/15,1	5 910 21/15,7	7 140 21/16,6	10 600 21/16,1	13 980 21/15,6	21 270 21/16,2	27 270 21/15,7	37 250 21/15,9	46 400 21/15,9	56 410 21/16			
	14	-	-	-	-	-	-	-	3 560 21/14,7	5 790 21/14,1	7 450 21/14,4	10 750 21/13,9	13 410 21/14,6	22 490 21/14,6	26 650 21/14,7	37 760 21/14,3	46 170 21/14,3	58 760 21/14,4			
	12,5	155 21/12,3	280 21/13,1	360 21/13,6	590 21/13,7	695 21/13,7	1 160 21/12,3	2 390 21/13,1	3 600 21/13,3	5 650 21/13,6	7 250 21/13,6	10 370 21/13	14 450 21/12,8	21 200 21/13,1	28 610 21/13,3	36 190 21/13,4	44 090 21/13,4	57 280 21/13,1			
	11,2	-	-	-	-	-	-	-	3 580 21/11,9	5 540 21/11,9	7 570 21/11,8	10 780 21/11,2	15 100 21/11,5	21 670 21/11,8	29 830 21/11,9	37 850 21/11,5	47 180 21/11,5	59 670 21/11,8			
	10	155 21/10,2	290 21/10,7	380 21/11,2	705 21/10,3	825 21/10,3	1 190 21/10,2	2 450 21/10,7	3 430 21/10,2	5 980 21/10,3	7 400 21/10,7	10 940 21/10,2	15 310 21/9,95	21 980 21/10,7	30 250 21/10,4	38 390 21/10,3	47 860 21/10,3	60 530 21/10,7			
	9	-	-	-	-	-	-	-	3 140 21/9,22	5 450 21/9,24	6 300 21/9,31	11 100 21/8,85	14 110 21/8,88	22 290 21/9,19	28 880 21/9,22	38 940 21/9,24	48 540 21/9,24	57 970 21/9,31			
	8	5,58 150 21/8,01	10,3 290 21/8,26	13 355 21/7,99	24,2 665 21/8,03	28,5 780 21/8,03	44,9 1 230 21/8,01	87,3 2 460 21/8,26	-	201 5 510 21/8,03	-	412 11 250 21/8,01	-	802 22 610 21/8,26▲	-	39 490 21/8,03	49 230 21/8,03	-	8	2800	355
	6,3	5,03 140 21/6,42	9,29 260 21/6,53	11 320 21/6,86	20,7 565 21/6,41	24,4 665 21/6,41	43,4 1 190 21/6,42	81,1 2 260 21/6,53	-	165 4 520 21/6,41	-	379 10 370 21/6,42	-	746 20 790 21/6,53	-	35 240 21/6,41	41 610 21/6,41	-	6,3	2240	
	5	-	10,3 270 1/5	-	20,6 570 1/5,2	-	42,2 1 080 1/4,82	82,9 2 200 1/5	125 3 310 1/5	196 5 130 1/4,92	237 6 360 1/5,07	365 9 540 1/4,92	454 12 210 1/5,07	573 15 440 1/5,08	910 24 150 1/5	1 168 30 510 1/4,92	1 460 38 140 1/4,92	1 567 42 170 1/5,07	5	1800	
	4,5	-	-	-	-	-	-	83,9 2 230 1/4,45	125 3 360 1/4,5	195 5 230 1/4,5	244 6 810 1/4,67	362 9 730 1/4,5	448 12 470 1/4,67	671 17 880 1/4,47	812 21 800 1/4,5	1 155 31 010 1/4,5	1 443 38 760 1/4,5	1 551 42 590 1/4,6	4,5	1600	
	4	-	11,9 325 1/4	-	24,4 695 1/4,16	-	41,8 1 120 1/3,92	83,4 2 270 1/4	128 3 550 1/4,08	190 5 360 1/4,13	239 6 760 1/4,15	353 9 970 1/4,13	468 13 010 1/4,07	618 16 860 1/4	882 24 540 1/4,08	1 130 31 350 1/4,07	1 413 39 190 1/4,07	1 528 41 690 1/4	4	1400	
	3,55	-	-	-	-	-	-	100 2 770 1/3,62	127 3 530 1/3,64	181 4 990 1/3,62	264 7 250 1/3,6	360 9 830 1/3,57	463 12 980 1/3,67	652 18 010 1/3,62	834 23 220 1/3,64	1 129 30 190 1/3,5	1 411 37 740 1/3,5	1 512 41 570 1/3,6	3,55	1250	
	3,15	-	11,6 325 1/3,28	-	25,8 690 1/3,13	-	51,3 1 430 1/3,27	99,9 2 800 1/3,28	134 3 580 1/3,13	200 5 350 1/3,13	260 7 220 1/3,25	357 9 950 1/3,27	486 13 160 1/3,18	618 17 310 1/3,28	928 25 230 1/3,19	1 120 29 920 1/3,13	1 400 37 400 1/3,13	1 493 41 360 1/3,25	3,15	1120	
2,8	-	-	-	-	-	-	105 2 770 1/2,75	132 3 550 1/2,82	197 5 300 1/2,81	255 6 900 1/2,83	374 10 080 1/2,82	475 12 860 1/2,83	686 18 430 1/2,81	866 23 340 1/2,82	1 103 29 630 1/2,81	1 379 37 030 1/2,81	1 550 41 940 1/2,83	2,8	1000		
2,5	-	12,5 335 1/2,53	-	27,4 710 1/2,44	-	48,6 1 320 1/2,55	104 2 790 1/2,53	137 3 660 1/2,53	183 4 750 1/2,44	230 6 090 1/2,5	367 9 960 1/2,55	473 12 200 1/2,43	643 17 270 1/2,53	898 24 070 1/2,53	1 152 29 880 1/2,44	1 440 37 350 1/2,44	1 599 42 410 1/2,5	2,5	900		

For n_1 lower than 560 min⁻¹ see page 107.

▲ Possible forced lubrication with heat exchanger: consult us.

7 - Selection tables (helical gear reducers)



$n_{N2} \cdot L_h$ min ⁻¹ · h	i_N	P_{N2} kW																i_N	n_1 min ⁻¹	n_{N2} min ⁻¹	
		M_{N2} N m																			
		50	63	64	80	81	100	125	140	160	180	200	225	250	280	320	321				360
4 500 000	2,24	-	-	-	-	-	-	101 2 750 1/2,28	132 3 630 1/2,3	164 4 330 1/2,21	204 5 450 1/2,24	340 8 930 1/2,2	423 11 470 1/2,27	627 17 460 1/2,33	870 23 890 1/2,3	1 119 30 240 1/2,26	1 399 37 800 1/2,26	1 545 42 150 1/2,29	2,24	800	355
	2	-	-	-	-	-	-	80,5 2 170 1/2	-	146 3 820 1/1,95	-	300 8 250 1/2,05	-	640 17 220 1/2	-	1 137 29 850 1/1,95	1 349 35 430 1/1,95	-	2	710	
4 000 000	45	-	-	-	-	-	-	-	3 370 31/45,1	5 300 31/44,4	6 560 31/44,2	10 600 31/45,4	14 450 31/46,6	19 840 31/46,7	24 180 31/47,1	30 650 31/45,5	38 140 31/45,5	48 360 31/46,8			
	40	-	270 31/40,8	335 31/42,5	580 31/43,6	670 31/43,6	1 180 31/39,1	2 100 31/40,8	2 990 31/38,7	5 320 31/38,5	6 130 31/39,9	10 900 31/41,5	12 950 31/40,4	18 660 31/42,4	24 820 31/41,2	31 460 31/40,7	39 150 31/40,7	49 640 31/42,3			
	35,5	-	-	-	-	-	-	-	3 050 31/37,5	5 210 31/36,5	6 460 31/36,3	10 420 31/34,4	12 930 31/35,4	18 890 31/36,9	25 500 31/37,2	32 320 31/37,4	40 230 31/37,4	51 000 31/38,4			
	31,5	-	270 31/33,5	300 31/34,9	570 31/32,8	670 31/32,8	1 170 31/32,6	1 950 31/33,5	3 010 31/32,2	4 670 31/31,6	6 250 31/32,8	9 860 31/31,5	13 260 31/30,6	18 930 31/33,5	26 150 31/32,5	33 150 31/33,5	41 250 31/33,5	52 300 31/34,7			
	28	-	-	-	-	-	975 21/28,8	-	2 800 31/29,1	4 770 31/28,4	5 600 31/28,6	9 700 31/27,2	12 590 31/27,3	19 470 31/28,7	25 160 31/28,8	34 090 31/30	42 420 31/30	51 640 31/30,3			
	25	120 21/24,4	255 21/24,1	315 21/25,1	500 21/26	585 21/26	1 150 21/23,7	2 240 21/24,1	3 250 21/24,1	5 000 21/24,6	6 860 21/25,4	10 160 21/24,2	13 020 21/25	20 520 21/25	25 850 21/24,6	28 680 21/25	41 210 21/25	45 790 21/25,7			
	22,4	-	-	-	-	-	-	-	3 590 21/21,7	5 640 21/22,5	7 370 21/23,3	10 390 21/22,2	13 330 21/23	22 540 21/22	25 490 21/22,2	32 320 21/22,8	42 010 21/22,8	51 060 21/23,4			
	20	140 21/20,1	285 21/19,3	360 21/20,1	590 21/20,8	695 21/20,8	1 210 21/19,3	2 420 21/19,3	3 660 21/19,6	5 770 21/20,7	7 040 21/20,8	10 610 21/20,3	14 070 21/20	21 490 21/19,7	27 760 21/20,1	35 190 21/20,6	42 770 21/20,6	55 630 21/20,3			
	18	-	-	-	-	-	-	-	3 640 21/17,6	5 680 21/18,1	7 600 21/18	10 600 21/17,6	14 880 21/18,1	22 060 21/17,8	29 330 21/17,9	37 250 21/17,8	46 400 21/17,8	58 300 21/18,3			
	16	160 21/16,3	295 21/15,8	385 21/16,5	700 21/15,7	830 21/15,7	1 250 21/16,1	2 360 21/15,8	3 470 21/15,1	6 110 21/15,7	7 240 21/16,6	10 750 21/16,1	14 170 21/15,6	21 560 21/16,2	27 640 21/15,7	37 760 21/15,9	47 030 21/15,9	57 180 21/16			
	14	-	-	-	-	-	-	-	3 680 21/14,7	5 970 21/14,1	7 600 21/14,4	10 880 21/13,9	13 580 21/14,6	22 570 21/14,6	26 980 21/14,7	38 240 21/14,3	46 750 21/14,3	59 510 21/14,4			
	12,5	160 21/12,3	290 21/13,1	360 21/13,6	595 21/13,7	700 21/13,7	1 200 21/12,3	2 480 21/13,1	3 730 21/13,3	5 850 21/13,6	7 350 21/13,6	10 520 21/13	14 660 21/12,8	21 960 21/13,1	29 020 21/13,3	36 700 21/13,4	44 720 21/13,4	58 090 21/13,1			
	11,2	-	-	-	-	-	-	-	3 710 21/11,9	5 750 21/11,9	7 690 21/11,8	10 940 21/11,2	15 310 21/11,5	22 250 21/11,8	30 250 21/11,9	38 390 21/11,5	47 860 21/11,5	60 530 21/11,8			
	10	165 21/10,2	305 21/10,7	395 21/11,2	705 21/10,3	830 21/10,3	1 240 21/10,2	2 540 21/10,7	3 470 21/10,2	6 200 21/10,3	7 670 21/10,7	11 100 21/10,2	15 530 21/9,95	22 290 21/10,7	30 690 21/10,4	38 940 21/10,3	48 540 21/10,3	61 400 21/10,7			
	9	-	-	-	-	-	-	-	101 3 180 21/9,22	175 5 530 21/9,24	201 6 390 21/9,31	373 11 250 21/8,85	473 14 310 21/8,88	721 22 610 21/9,19 ▲	931 29 290 21/9,22 ▲	-	-	-	9	2800	315
	8	5,05 155 21/8,01	9,48 300 21/8,26	11,8 360 21/7,99	22,4 685 21/8,03	26,3 810 21/8,03	40,7 1 240 21/8,01	80,1 2 530 21/8,26	-	182 5 590 21/8,03	-	373 11 410 21/8,01	-	726 22 920 21/8,26 ▲	-	-	-	-	8	2500	

For n_1 lower than 560 min⁻¹ see page 107.

▲ Possible forced lubrication with heat exchanger: consult us.

7 - Selection tables (helical gear reducers)



$n_{N2} \cdot L_h$ min ⁻¹ · h	i_N	P_{N2} kW																i_N	n_1 min ⁻¹	n_{N2} min ⁻¹	
		M_{N2} N m																			
		... / i																			
		50	63	64	80	81	100	125	140	160	180	200	225	250	280	320	321	360			
4 000 000	6,3	4,55 140 2/6,42	8,41 260 2/6,53	10,1 330 2/6,86	19,1 585 2/6,41	22,5 690 2/6,41	40,1 1 230 2/6,42	73,4 2 290 2/6,53	-	150 4 580 2/6,41	-	343 10 510 2/6,42	-	675 21 070 2/6,53	-	1 166 35 720 2/6,41 ▲	1 377 42 170 2/6,41 ▲	-	6,3	2000	315
	5	-	9,38 280 1/5	-	18,4 570 1/5,2	-	38,9 1 120 1/4,82	76,3 2 280 1/5	114 3 400 1/5	175 5 150 1/4,92	218 6 590 1/5,07	336 9 890 1/4,92	418 12 650 1/5,07	528 16 000 1/5,08	838 25 010 1/5	1 076 31 610 1/4,92	1 345 39 510 1/4,92	1 443 43 680 1/5,07	5	1600	
	4,5	-	-	-	-	-	-	76,4 2 320 1/4,45	114 3 500 1/4,5	177 5 450 1/4,5	223 7 080 1/4,67	330 10 130 1/4,5	408 12 980 1/4,67	611 18 610 1/4,47	739 22 690 1/4,5	1 052 32 280 1/4,5	1 314 40 350 1/4,5	1 413 44 330 1/4,6	4,5	1400	
	4	-	10,6 325 1/4	-	21,9 695 1/4,16	-	38,7 1 160 1/3,92	77 2 350 1/4	118 3 670 1/4,08	176 5 540 1/4,13	220 6 990 1/4,15	327 10 310 1/4,13	433 13 460 1/4,07	571 17 440 1/4	815 25 390 1/4,08	1 044 32 430 1/4,07	1 305 40 540 1/4,07	1 411 43 130 1/4	4	1250	
	3,55	-	-	-	-	-	-	92,8 2 860 1/3,62	118 3 650 1/3,64	167 5 160 1/3,62	244 7 490 1/3,6	334 10 160 1/3,57	429 13 420 1/3,67	604 18 610 1/3,62	772 23 990 1/3,64	1 045 31 200 1/3,5	1 307 39 000 1/3,5	1 400 42 970 1/3,6	3,55	1120	
	3,15	-	10,7 335 1/3,28	-	23,7 710 1/3,13	-	45,8 1 430 1/3,27	92,3 2 890 1/3,28	124 3 700 1/3,13	185 5 530 1/3,13	241 7 460 1/3,25	330 10 300 1/3,27	449 13 620 1/3,18	571 17 910 1/3,28	858 26 100 1/3,19	1 034 30 950 1/3,13	1 293 38 690 1/3,13	1 379 42 800 1/3,25	3,15	1000	
	2,8	-	-	-	-	-	-	97,9 2 860 1/2,75	122 3 670 1/2,82	183 5 450 1/2,81	230 6 900 1/2,83	347 10 400 1/2,82	441 13 270 1/2,83	637 19 020 1/2,81	804 24 090 1/2,82	1 025 30 580 1/2,81	1 281 38 220 1/2,81	1 440 43 290 1/2,83	2,8	900	
	2,5	-	11,1 335 1/2,53	-	24,3 710 1/2,44	-	43,2 1 320 1/2,55	95,7 2 890 1/2,53	126 3 790 1/2,53	163 4 750 1/2,44	204 6 090 1/2,5	338 10 300 1/2,55	421 12 200 1/2,43	592 17 890 1/2,53	827 24 940 1/2,53	1 061 30 950 1/2,44	1 326 38 690 1/2,44	1 472 43 930 1/2,5	2,5	800	
	2,24	-	-	-	-	-	-	93,2 2 860 1/2,28	118 3 650 1/2,3	146 4 330 1/2,21	181 5 450 1/2,24	302 8 930 1/2,2	375 11 470 1/2,27	577 18 100 1/2,33	800 24 760 1/2,3	1 030 31 340 1/2,26	1 287 39 170 1/2,26	1 421 43 690 1/2,29	2,24	710	
	2	-	-	-	-	-	-	72,4 2 190 1/2	-	129 3 820 1/1,95	-	266 8 250 1/2,05	-	577 17 500 1/2	-	1 014 30 000 1/1,95	1 197 35 430 1/1,95	-	2	630	
3 550 000	50	-	265 3/49,4	335 3/51,5	560 3/49,8	670 3/49,8	1 150 3/51,2	2 150 3/49,5	3 450 3/50,4	5 150 3/50,8	7 300 3/51	10 300 3/52,6	14 500 3/51,8	20 600 3/51,7	23 500 3/52,7	32 050 3/52,9	40 060 3/52,9	46 990 3/52			
	45	-	-	-	-	-	-	3 480 3/45,1	5 300 3/44,4	6 790 3/44,2	10 900 3/45,4	14 950 3/46,6	20 530 3/46,7	24 820 3/47,1	31 460 3/45,5	39 150 3/45,5	49 640 3/46,8				
	40	-	280 3/40,8	335 3/42,5	595 3/43,6	670 3/43,6	1 220 3/39,1	2 170 3/40,8	3 090 3/38,7	5 500 3/38,5	6 340 3/39,9	11 200 3/41,5	13 380 3/40,4	19 280 3/42,4	25 500 3/41,2	32 320 3/40,7	40 230 3/40,7	51 000 3/42,3			
	35,5	-	-	-	-	-	-	3 130 3/37,5	5 390 3/36,5	6 630 3/36,3	10 780 3/34,4	13 260 3/35,4	19 540 3/36,9	26 150 3/37,2	33 150 3/37,4	41 250 3/37,4	52 300 3/38,4				
	31,5	-	280 3/33,5	305 3/34,9	585 3/32,8	690 3/32,8	1 210 3/32,6	2 010 3/33,5	3 090 3/32,2	4 820 3/31,6	6 430 3/32,8	10 180 3/31,5	13 640 3/30,6	19 470 3/33,5	26 890 3/32,5	34 090 3/33,5	42 420 3/33,5	53 790 3/34,7			
	28	-	-	-	-	-	1 030 2/28,8	-	2 890 3/29,1	4 930 3/28,4	5 790 3/28,6	10 010 3/27,2	12 990 3/27,3	20 100 3/28,7	25 970 3/28,8	35 190 3/30	43 800 3/30	53 320 3/30,3			
	25	120 2/24,4	265 2/24,1	325 2/25,1	500 2/26	590 2/26	1 180 2/23,7	2 300 2/24,1	3 410 2/24,1	5 150 2/24,6	7 110 2/25,4	10 530 2/24,2	13 490 2/25	21 270 2/25	26 790 2/24,6	29 460 2/25	42 720 2/25	47 340 2/25,7			
	22,4	-	-	-	-	-	-	-	3 730 2/21,7	5 600 2/22,5	7 640 2/23,3	10 760 2/22,2	13 820 2/23	22 620 2/22	26 160 2/22,2	33 180 2/22,8	43 540 2/22,8	52 410 2/23,4			

For n_1 lower than 560 min⁻¹ see page 107.

▲ Possible forced lubrication with heat exchanger: consult us.

7 - Selection tables (helical gear reducers)

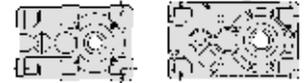

$n_{N2} \cdot L_h$ min ⁻¹ · h	i_N	P_{N2} kW																i_N	n_1 min ⁻¹	n_{N2} min ⁻¹	
		M_{N2} N m																			
		50	63	64	80	81	100	125	140	160	180	200	225	250	280	320	321				360
3 550 000	20	145 21/20,1	295 21/19,3	365 21/20,1	595 21/20,8	700 21/20,8	1 260 21/19,3	2 510 21/19,3	3 790 21/19,6	5 980 21/20,7	7 290 21/20,8	11 000 21/20,3	14 450 21/20	22 260 21/19,7	28 520 21/20,1	36 150 21/20,6	43 950 21/20,6	57 150 21/20,3			
	18	-	-	-	-	-	-	-	3 770 21/17,6	5 870 21/18,1	7 870 21/18	10 870 21/17,6	15 080 21/18,1	22 830 21/17,8	29 730 21/17,9	37 760 21/17,8	47 030 21/17,8	59 100 21/18,3			
	16	165 21/16,3	305 21/15,8	395 21/16,5	705 21/15,7	830 21/15,7	1 290 21/16,1	2 430 21/15,8	3 520 21/15,1	6 310 21/15,7	7 330 21/16,6	10 980 21/16,1	14 350 21/15,6	21 830 21/16,2	27 990 21/15,7	38 240 21/15,9	47 630 21/15,9	57 910 21/16			
	14	-	-	-	-	-	-	-	3 810 21/14,7	6 190 21/14,1	7 870 21/14,4	11 100 21/13,9	13 770 21/14,6	22 650 21/14,6	27 370 21/14,7	38 780 21/14,3	47 420 21/14,3	60 350 21/14,4			
	12,5	165 21/12,3	305 21/13,1	365 21/13,6	595 21/13,7	700 21/13,7	1 240 21/12,3	2 570 21/13,1	3 870 21/13,3	6 060 21/13,6	7 450 21/13,6	10 880 21/13	14 870 21/12,8	22 760 21/13,1	29 430 21/13,3	37 230 21/13,4	45 360 21/13,4	58 930 21/13,1			
	11,2	-	-	-	-	-	-	-	3 840 21/11,9	5 960 21/11,9	7 970 21/11,8	11 100 21/11,2	15 530 21/11,5	23 060 21/11,8	30 690 21/11,9	38 940 21/11,5	48 540 21/11,5	61 400 21/11,8			
	10	4,84 170 21/10,2	8,56 315 21/10,7	10,7 410 21/11,2	20,2 710 21/10,3	23,7 835 21/10,3	36,7 1 280 21/10,2	71,9 2 630 21/10,7	101 3 520 21/10,2	183 6 420 21/10,3	218 7 940 21/10,7	322 11 250 21/10,2	464 15 750 21/9,95	618 22 610 21/10,7▲	876 31 120 21/10,4▲	- 39 490 21/10,3	- 49 230 21/10,3	- 62 270 21/10,7	10	2800	280
	9	-	-	-	-	-	-	-	91,6 3 230 21/9,22	159 5 600 21/9,24	182 6 480 21/9,31	338 11 410 21/8,85	428 14 510 21/8,88	653 22 920 21/9,19▲	843 29 690 21/9,22▲	- 40 030 21/9,24	- 49 900 21/9,24	- 59 590 21/9,31	9	2500	
	8	4,59 155 21/8,01	8,78 310 21/8,26	11 375 21/7,99	20,7 710 21/8,03	24,4 835 21/8,03	37,4 1 280 21/8,01	74,2 2 610 21/8,26	- 5 660 21/8,03	165 - 5 660	- - -	339 11 560 21/8,01	- - -	659 23 220 21/8,26	- - -	- 40 560 21/8,03	- 50 560 21/8,03	- - -	8	2240	
	6,3	4,15 140 21/6,42	7,66 265 21/6,53	9,41 345 21/6,86	17,6 600 21/6,41	20,9 710 21/6,41	37,2 1 270 21/6,42	66,9 2 320 21/6,53	- 4 640 21/6,41	136 - 4 640	- - -	313 10 640 21/6,42	- - -	616 21 340 21/6,53	- - -	1 063 36 170 21/6,41	1 255 42 710 21/6,41	- -	6,3	1800	
	5	-	8,21 280 1/5	-	16,1 570 1/5,2	-	35,4 1 160 1/4,82	69,5 2 370 1/5	100 3 420 1/5	153 5 150 1/4,92	198 6 860 1/5,07	306 10 290 1/4,92	380 13 160 1/5,07	481 16 650 1/5,08	763 26 040 1/5	980 32 900 1/4,92	1 225 41 120 1/4,92	1 314 45 470 1/5,07	5	1400	
	4,5	-	-	-	-	-	-	70,6 2 400 1/4,45	105 3 620 1/4,5	164 5 630 1/4,5	206 7 330 1/4,67	305 10 480 1/4,5	377 13 430 1/4,67	564 19 250 1/4,47	683 23 480 1/4,5	971 33 390 1/4,5	1 214 41 740 1/4,5	1 305 45 860 1/4,6	4,5	1250	
	4	-	9,53 325 1/4	-	19,7 700 1/4,16	-	35,8 1 200 1/3,92	71,3 2 430 1/4	109 3 800 1/4,08	163 5 730 1/4,13	204 7 230 1/4,15	302 10 660 1/4,13	401 13 910 1/4,07	528 18 020 1/4	755 26 240 1/4,08	967 33 520 1/4,07	1 208 41 900 1/4,07	1 307 44 570 1/4	4	1120	
	3,55	-	-	-	-	-	-	81,1 2 800 1/3,62	109 3 780 1/3,64	155 5 340 1/3,62	226 7 750 1/3,6	308 10 510 1/3,57	396 13 880 1/3,67	558 19 260 1/3,62	714 24 820 1/3,64	966 32 280 1/3,5	1 207 40 350 1/3,5	1 293 44 450 1/3,6	3,55	1000	
	3,15	-	9,61 335 1/3,28	-	21,4 710 1/3,13	-	41,2 1 430 1/3,27	83,2 2 900 1/3,28	115 3 820 1/3,13	172 5 710 1/3,13	223 7 700 1/3,25	307 10 630 1/3,27	417 14 060 1/3,18	530 18 490 1/3,28	797 26 940 1/3,19	961 31 950 1/3,13	1 201 39 930 1/3,13	1 281 44 170 1/3,25	3,15	900	
2,8	-	-	-	-	-	-	90,1 2 960 1/2,75	113 3 800 1/2,82	162 5 450 1/2,81	204 6 900 1/2,83	320 10 780 1/2,82	406 13 750 1/2,83	587 19 700 1/2,81	740 24 960 1/2,82	944 31 680 1/2,81	1 179 39 600 1/2,81	1 326 44 850 1/2,83	2,8	800		
2,5	-	10,1 345 1/2,53	-	22,5 740 1/2,44	-	38,3 1 320 1/2,55	88 3 000 1/2,53	116 3 930 1/2,53	144 4 750 1/2,44	181 6 090 1/2,5	300 10 300 1/2,55	373 12 200 1/2,43	545 18 540 1/2,53	761 25 850 1/2,53	976 32 080 1/2,44	1 220 40 100 1/2,44	1 354 45 530 1/2,5	2,5	710		
2,24	-	-	-	-	-	-	84 2 900 1/2,28	105 3 650 1/2,3	129 4 330 1/2,21	161 5 450 1/2,24	268 8 930 1/2,2	333 11 470 1/2,27	530 18 760 1/2,33	717 25 000 1/2,3	947 32 480 1/2,26	1 184 40 600 1/2,26	1 307 45 290 1/2,29	2,24	630		

For n_1 lower than 560 min⁻¹ see page 107.

▲ Possible forced lubrication with heat exchanger: consult us.

7 - Selection tables (helical gear reducers)



$n_{N2} \cdot L_h$ min ⁻¹ · h	i_N	P_{N2} kW																i_N	n_1	n_{N2}		
		50	63	64	80	81	100	125	140	160	180	200	225	250	280	320	321				360	
3 550 000	2	-	-	-	-	-	-	65,2 2 220 1/2	-	115 3 820 1/1,95	-	236 8 250 1/2,05	-	513 17 500 1/2	-	901 30 000 1/1,95	1 064 35 430 1/1,95	-	2	560	280	
3 150 000	56	-	-	-	-	-	-	3 450 31/55,4	5 300 31/55,5	7 100 31/55,3	10 600 31/54,1	14 830 31/55,5	21 230 31/55,6	24 180 31/56	30 650 31/57,8	38 140 31/57,8	48 360 31/59,4					
	50	-	270 31/49,4	345 31/51,5	580 31/49,8	690 31/49,8	1 180 31/51,2	2 220 31/49,5	3 550 31/50,4	5 300 31/50,8	7 500 31/51	10 600 31/52,6	15 000 31/51,8	21 200 31/51,7	24 120 31/52,7	33 160 31/52,9	41 450 31/52,9	48 240 31/52				
	45	-	-	-	-	-	-	3 600 31/45,1	5 450 31/44,4	7 020 31/44,2	11 200 31/45,4	15 450 31/46,6	21 220 31/46,7	25 500 31/47,1	32 320 31/45,5	40 230 31/45,5	51 000 31/46,8					
	40	-	280 31/40,8	345 31/42,5	600 31/43,6	705 31/43,6	1 250 31/39,1	2 250 31/40,8	3 190 31/38,7	5 690 31/38,5	6 560 31/39,9	11 500 31/41,5	13 840 31/40,4	19 950 31/42,4	26 150 31/41,2	33 150 31/40,7	41 250 31/40,7	52 300 31/42,3				
	35,5	-	-	-	-	-	-	3 220 31/37,5	5 560 31/36,5	6 820 31/36,3	11 130 31/34,4	13 640 31/35,4	20 170 31/36,9	26 890 31/37,2	34 090 31/37,4	42 420 31/37,4	53 790 31/38,4					
	31,5	-	290 31/33,5	315 31/34,9	610 31/32,8	715 31/32,8	1 250 31/32,6	2 070 31/33,5	3 200 31/32,2	5 000 31/31,6	6 640 31/32,8	10 540 31/31,5	14 080 31/30,6	20 100 31/33,5	27 760 31/32,5	35 190 31/33,5	43 800 31/33,5	55 530 31/34,7				
	28	-	-	-	-	-	1 030 21/28,8	-	2 970 31/29,1	5 060 31/28,4	5 940 31/28,6	10 290 31/27,2	13 350 31/27,3	20 650 31/28,7	26 680 31/28,8	36 160 31/30	45 000 31/30	54 780 31/30,3				
	25	125 21/24,4	270 21/24,1	335 21/25,1	505 21/26	590 21/26	1 180 21/23,7	2 440 21/24,1	3 420 21/24,1	5 150 21/24,6	7 370 21/25,4	10 820 21/24,2	13 990 21/25	21 200 21/25	27 770 21/24,6	30 250 21/25	44 280 21/25	49 070 21/25,7				
	22,4	-	-	-	-	-	-	-	3 860 21/21,7	5 800 21/22,5	7 910 21/23,3	11 150 21/22,2	14 310 21/23	22 710 21/22	26 880 21/22,2	34 090 21/22,8	45 110 21/22,8	53 850 21/23,4				
	20	145 21/20,1	305 21/19,3	365 21/20,1	595 21/20,8	700 21/20,8	1 300 21/19,3	2 600 21/19,3	3 920 21/19,6	6 180 21/20,7	7 550 21/20,8	11 380 21/20,3	14 650 21/20	23 030 21/19,7	28 910 21/20,1	36 650 21/20,6	45 440 21/20,6	57 930 21/20,3				
	18	-	-	-	-	-	-	-	3 890 21/17,6	6 060 21/18,1	8 120 21/18	11 220 21/17,6	15 270 21/18,1	23 560 21/17,8	30 100 21/17,9	38 240 21/17,8	47 630 21/17,8	59 840 21/18,3				
	16	170 21/16,3	315 21/15,8	410 21/16,5	705 21/15,7	835 21/15,7	1 340 21/16,1	2 520 21/15,8	3 570 21/15,1	6 540 21/15,7	7 560 21/16,6	11 380 21/16,1	14 550 21/15,6	22 180 21/16,2	28 380 21/15,7	38 780 21/15,9	48 300 21/15,9	58 730 21/16				
	14	-	-	-	-	-	-	-	3 940 21/14,7	6 420 21/14,1	8 160 21/14,4	11 510 21/13,9	14 160 21/14,6	22 740 21/14,6	27 760 21/14,7	39 340 21/14,3	48 100 21/14,3	61 210 21/14,4				
	12,5	170 21/12,3	315 21/13,1	365 21/13,6	600 21/13,7	705 21/13,7	1 290 21/12,3	2 660 21/13,1	4 010 21/13,3	6 280 21/13,6	7 660 21/13,6	11 280 21/13	15 080 21/12,8	23 590 21/13,1	29 860 21/13,3	37 760 21/13,4	46 010 21/13,4	59 770 21/13,1				
	11,2	-	-	-	-	-	-	-	98,1 3 980 21/11,9	152 6 170 21/11,9	205 8 260 21/11,8	295 11 250 21/11,2	402 15 750 21/11,5	593 23 890 21/11,8▲	767 31 120 21/11,9▲	- 39 900 21/11,5	- 49 870 21/11,5	- 62 270 21/11,8		11,2	2800	250
	10	4,47 175 21/10,2	7,91 325 21/10,7	9,68 415 21/11,2	18,1 710 21/10,3	21,2 835 21/10,3	33,9 1 320 21/10,2	66,5 2 720 21/10,7	91,6 3 570 21/10,2	169 6 640 21/10,3	201 8 220 21/10,7	292 11 410 21/10,2	420 15 970 21/9,95	559 22 920 21/10,7▲	793 31 550 21/10,4▲	- 40 030 21/10,3	- 49 900 21/10,3	- 63 120 21/10,7		10	2500	
	9	-	-	-	-	-	-	-	83,9 3 300 21/9,22	144 5 680 21/9,24	165 6 560 21/9,31	306 11 560 21/8,85	388 14 700 21/8,88	593 23 220 21/9,19	765 30 080 21/9,22	- 40 560 21/9,24	- 50 560 21/9,24	- 60 380 21/9,31		9	2240	

For n_1 lower than 560 min⁻¹ see page 107.

▲ Possible forced lubrication with heat exchanger: consult us.

7 - Selection tables (helical gear reducers)

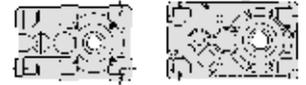

$n_{N2} \cdot L_h$ min ⁻¹ · h	i_N	P_{N2} kW M_{N2} N m ... /i																i_N	n_1 min ⁻¹	n_{N2} min ⁻¹		
		50	63	64	80	81	100	125	140	160	180	200	225	250	280	320	321				360	
3 150 000	8	4,15 160 2/8,01	8,11 320 2/8,26	10,1 385 2/7,99	19,1 735 2/8,03	22,5 865 2/8,03	34,6 1 320 2/8,01	68,6 2 700 2/8,26	-	150 5 740 2/8,03	-	306 11 710 2/8,01	-	596 23 530 2/8,26	-	1 072 41 110 2/8,03▲	1 336 51 250 2/8,03▲	-	8	2000	250	
	6,3	3,74 145 2/6,42	6,93 270 2/6,53	8,67 355 2/6,86	15,7 600 2/6,41	19,3 740 2/6,41	34,3 1 310 2/6,42	60,3 2 350 2/6,53	-	123 4 710 2/6,41	-	282 10 790 2/6,42	-	555 21 640 2/6,53	-	958 36 680 2/6,41	1 131 43 310 2/6,41	-	6,3	1600		
	5	-	7,33 280 1/5	-	14,5 575 1/5,2	-	32,7 1 200 1/4,82	64,2 2 450 1/5	89,4 3 420 1/5	143 5 360 1/4,92	183 7 100 1/5,07	283 10 650 1/4,92	351 13 620 1/5,07	444 17 230 1/5,08	705 26 940 1/5	905 34 040 1/4,92	1 131 42 550 1/4,92	1 214 47 040 1/5,07	5	1250		
	4,5	-	-	-	-	-	-	65,4 2 480 1/4,45	94,5 3 630 1/4,5	151 5 790 1/4,5	190 7 580 1/4,67	282 10 830 1/4,5	349 13 870 1/4,67	522 19 900 1/4,47	632 24 270 1/4,5	899 34 510 1/4,5	1 124 43 140 1/4,5	1 208 47 390 1/4,6	4,5	1120		
	4	-	8,77 335 1/4	-	17,6 700 1/4,16	-	33,1 1 240 1/3,92	65,9 2 520 1/4	101 3 930 1/4,08	150 5 930 1/4,13	188 7 480 1/4,15	279 11 020 1/4,13	370 14 390 1/4,07	488 18 650 1/4	697 27 150 1/4,08	893 34 680 1/4,07	1 116 43 350 1/4,07	1 207 46 110 1/4	4	1000		
	3,55	-	-	-	-	-	-	75,6 2 900 1/3,62	101 3 900 1/3,64	144 5 510 1/3,62	210 8 000 1/3,6	286 10 850 1/3,57	368 14 330 1/3,67	518 19 880 1/3,62	663 25 620 1/3,64	897 33 320 1/3,5	1 121 41 640 1/3,5	1 201 45 880 1/3,6	3,55	900		
	3,15	-	8,54 335 1/3,28	-	19 710 1/3,13	-	36,6 1 430 1/3,27	73,9 2 900 1/3,28	106 3 960 1/3,13	158 5 920 1/3,13	204 7 920 1/3,25	282 11 010 1/3,27	384 14 560 1/3,18	488 19 150 1/3,28	734 27 910 1/3,19	885 33 100 1/3,13	1 106 41 370 1/3,13	1 179 45 760 1/3,25	3,15	800		
	2,8	-	-	-	-	-	-	81,1 3 000 1/2,75	104 3 940 1/2,82	144 5 450 1/2,81	181 6 900 1/2,83	294 11 170 1/2,82	374 14 250 1/2,83	540 20 420 1/2,81	681 25 870 1/2,82	868 32 830 1/2,81	1 085 41 040 1/2,81	1 220 46 480 1/2,83	2,8	710		
	2,5	-	9 345 1/2,53	-	20 740 1/2,44	-	34 1 320 1/2,55	78,2 3 000 1/2,53	104 4 000 1/2,53	128 4 750 1/2,44	161 6 090 1/2,5	266 10 300 1/2,55	331 12 200 1/2,43	501 19 220 1/2,53	700 26 790 1/2,53	897 33 250 1/2,44	1 122 41 560 1/2,44	1 245 47 190 1/2,5	2,5	630		
	2,24	-	-	-	-	-	-	74,7 2 900 1/2,28	93,1 3 650 1/2,3	115 4 330 1/2,21	143 5 450 1/2,24	238 8 930 1/2,2	296 11 470 1/2,27	488 19 440 1/2,33	637 25 000 1/2,3	872 33 650 1/2,26	1 064 41 080 1/2,26	1 185 46 200 1/2,29	2,24	560		
	2 800 000	63	-	265 3/60,1	325 3/62,6	560 3/66,3	650 3/66,3	1 150 3/61,5	2 300 3/60,2	3 450 3/62	5 150 3/63,5	7 300 3/63,8	10 300 3/62,6	14 500 3/61,7	20 600 3/61,5	23 940 3/62,7	34 500 3/67,1	43 120 3/67,1	46 990 3/66			
		56	-	-	-	-	-	-	3 550 3/55,4	5 300 3/55,5	7 300 3/55,3	10 900 3/54,1	15 340 3/55,5	21 960 3/55,6	24 820 3/56	31 460 3/57,8	39 150 3/57,8	49 640 3/59,4				
50		-	280 3/49,4	355 3/51,5	580 3/49,8	710 3/49,8	1 220 3/51,2	2 300 3/49,5	3 650 3/50,4	5 450 3/50,8	7 750 3/51	10 900 3/52,6	15 500 3/51,8	21 800 3/51,7	24 780 3/52,7	34 270 3/52,9	42 840 3/52,9	49 560 3/52				
45		-	-	-	-	-	-	3 720 3/45,1	5 600 3/44,4	7 260 3/44,2	11 500 3/45,4	15 980 3/46,6	21 950 3/46,7	26 150 3/47,1	33 150 3/45,5	41 250 3/45,5	52 300 3/46,8					
40		-	290 3/40,8	365 3/42,5	600 3/43,6	705 3/43,6	1 280 3/39,1	2 320 3/40,8	3 300 3/38,7	5 870 3/38,5	6 770 3/39,9	11 800 3/41,5	14 290 3/40,4	20 590 3/42,4	26 890 3/41,2	34 090 3/40,7	42 420 3/40,7	53 790 3/42,3				
35,5		-	-	-	-	-	-	3 320 3/37,5	5 760 3/36,5	7 040 3/36,3	11 530 3/34,4	14 080 3/35,4	20 890 3/36,9	27 760 3/37,2	35 190 3/37,4	43 800 3/37,4	55 530 3/38,4					
31,5		-	290 3/33,5	325 3/34,9	630 3/32,8	740 3/32,8	1 250 3/32,6	2 130 3/33,5	3 280 3/32,2	5 180 3/31,6	6 820 3/32,8	10 930 3/31,5	14 460 3/30,6	20 650 3/33,5	28 530 3/32,5	36 160 3/33,5	45 000 3/33,5	57 050 3/34,7				
28		-	-	-	-	-	1 060 2/28,8	-	3 040 3/29,1	5 200 3/28,4	6 100 3/28,6	10 560 3/27,2	13 700 3/27,3	21 200 3/28,7	27 390 3/28,8	37 120 3/30	46 190 3/30	56 230 3/30,3				

For n_1 lower than 560 min⁻¹ see page 107.

▲ Possible forced lubrication with heat exchanger: consult us.

7 - Selection tables (helical gear reducers)



$n_{N2} \cdot L_h$ min ⁻¹ · h	i_N	P_{N2} kW M_{N2} N m ... / i																i_N	n_1 min ⁻¹	n_{N2} min ⁻¹	
		50	63	64	80	81	100	125	140	160	180	200	225	250	280	320	321				360
2 800 000	25	125 2I/24,4	280 2I/24,1	335 2I/25,1	505 2I/26	595 2I/26	1 220 2I/23,7	2 450 2I/24,1	3 440 2I/24,1	5 380 2I/24,6	7 630 2I/25,4	10 860 2I/24,2	14 490 2I/25	22 360 2I/25	28 770 2I/24,6	31 070 2I/25	45 870 2I/25	50 840 2I/25,7			
	22,4	-	-	-	-	-	-	-	3 950 2I/21,7	6 000 2I/22,5	8 190 2I/23,3	11 540 2I/22,2	14 810 2I/23	22 790 2I/22	27 250 2I/22,2	34 550 2I/22,8	46 670 2I/22,8	54 580 2I/23,4			
	20	145 2I/20,1	315 2I/19,3	365 2I/20,1	600 2I/20,8	705 2I/20,8	1 340 2I/19,3	2 680 2I/19,3	4 050 2I/19,6	6 380 2I/20,7	7 790 2I/20,8	11 740 2I/20,3	14 830 2I/20	23 770 2I/19,7	29 270 2I/20,1	37 110 2I/20,6	46 900 2I/20,6	58 660 2I/20,3			
	18	-	-	-	-	-	-	-	4 030 2I/17,6	6 280 2I/18,1	8 410 2I/18	11 630 2I/17,6	15 490 2I/18,1	24 410 2I/17,8	30 530 2I/17,9	38 780 2I/17,8	48 300 2I/17,8	60 690 2I/18,3			
	16	170 2I/16,3	325 2I/15,8	415 2I/16,5	710 2I/15,7	840 2I/15,7	1 390 2I/16,1	2 610 2I/15,8	3 680 2I/15,1	6 770 2I/15,7	7 830 2I/16,6	11 790 2I/16,1	14 930 2I/15,6	22 990 2I/16,2	28 790 2I/15,7	39 850 2I/15,9	49 810 2I/15,9	59 570 2I/16			
	14	-	-	-	-	-	-	-	3 960 2I/14,7	6 650 2I/14,1	8 450 2I/14,4	11 930 2I/13,9	14 680 2I/14,6	22 820 2I/14,6	28 160 2I/14,7	39 900 2I/14,3	48 790 2I/14,3	62 090 2I/14,4			
	12,5	4,05 170 2I/12,3	7,3 325 2I/13,1	7,9 365 2I/13,6	12,9 600 2I/13,7	15,1 705 2I/13,7	31,8 1 330 2I/12,3	61,9 2 760 2I/13,1	91,5 4 150 2I/13,3	139 6 440 2I/13,6	170 7 930 2I/13,6	264 11 680 2I/13	351 15 290 2I/12,8	548 24 440 2I/13,1▲	667 30 280 2I/13,3▲	- 38 300 2I/13,4	- 47 590 2I/13,4	- 60 620 2I/13,1	12,5	2800	224
	11,2	-	-	-	-	-	-	-	90,6 4 120 2I/11,9	141 6 380 2I/11,9	189 8 550 2I/11,8	270 11 530 2I/11,2	364 15 970 2I/11,5	548 24 720 2I/11,8▲	694 31 550 2I/11,9▲	- 41 280 2I/11,5	- 51 600 2I/11,5	- 63 120 2I/11,8	11,2	2500	
	10	4,14 180 2I/10,2	7,32 335 2I/10,7	8,71 415 2I/11,2	16,2 715 2I/10,3	19,1 840 2I/10,3	31,4 1 370 2I/10,2	61,5 2 820 2I/10,7	83,9 3 650 2I/10,2	156 6 860 2I/10,3	187 8 490 2I/10,7	267 11 640 2I/10,2	381 16 180 2I/9,95	507 23 220 2I/10,7	720 31 960 2I/10,4	- 40 860 2I/10,3	- 51 070 2I/10,3	- 63 950 2I/10,7	10	2240	
	9	-	-	-	-	-	-	-	77,5 3 410 2I/9,22	130 5 760 2I/9,24	150 6 650 2I/9,31	278 11 730 2I/8,85	352 14 900 2I/8,88	536 23 530 2I/9,19	692 30 490 2I/9,22	932 41 110 2I/9,24▲	1 161 51 250 2I/9,24▲	1 377 61 200 2I/9,31▲	9	2000	
	8	3,78 160 2I/8,01	7,53 330 2I/8,26	9,41 400 2I/7,99	17,6 750 2I/8,03	20,9 890 2I/8,03	32,1 1 360 2I/8,01	63,7 2 790 2I/8,26	- -	136 5 810 2I/8,03	- -	279 11 860 2I/8,01	- -	544 23 830 2I/8,26	- -	977 41 630 2I/8,03	1 218 51 900 2I/8,03	- -	8	1800	
	6,3	3,33 145 2I/6,42	6,32 280 2I/6,53	7,89 370 2I/6,86	13,8 605 2I/6,41	17,3 755 2I/6,41	31,2 1 370 2I/6,53	53,6 2 390 2I/6,53	- -	109 4 780 2I/6,41	- -	251 10 970 2I/6,42	- -	493 21 990 2I/6,53	- -	852 37 270 2I/6,41	1 006 44 010 2I/6,41	- -	6,3	1400	
	5	-	6,8 290 I/5	-	13 575 I/5,2	-	29,9 1 230 I/4,82	58,7 2 500 I/5	80,1 3 420 I/5	128 5 380 I/4,92	168 7 260 I/5,07	259 10 860 I/4,92	324 14 000 I/5,07	411 17 800 I/5,08	653 27 840 I/5	838 35 180 I/4,92	1 048 43 970 I/4,92	1 124 48 620 I/5,07	5	1120	
	4,5	-	-	-	-	-	-	59,9 2 550 I/4,45	84,4 3 630 I/4,5	135 5 810 I/4,5	176 7 840 I/4,67	261 11 200 I/4,5	322 14 350 I/4,67	483 20 580 I/4,47	584 25 100 I/4,5	831 35 710 I/4,5	1 039 44 630 I/4,5	1 116 49 030 I/4,6	4,5	1000	
	4	-	8,06 340 I/4	-	15,9 705 I/4,16	-	30,7 1 280 I/3,92	61,2 2 600 I/4	93,7 4 050 I/4,08	139 6 120 I/4,13	175 7 720 I/4,15	259 11 380 I/4,13	344 14 850 I/4,07	453 19 240 I/4	648 28 020 I/4,08	829 35 790 I/4,07	1 037 44 740 I/4,07	1 121 47 590 I/4	4	900	
	3,55	-	-	-	-	-	-	67,2 2 900 I/3,62	92,9 4 040 I/3,64	132 5 710 I/3,62	192 8 250 I/3,6	264 11 240 I/3,57	339 14 840 I/3,67	477 20 590 I/3,62	610 26 540 I/3,64	826 34 510 I/3,5	1 033 43 140 I/3,5	1 106 47 530 I/3,6	3,55	800	
3,15	-	7,81 345 I/3,28	-	17,3 730 I/3,13	-	32,5 1 430 I/3,27	67,9 3 000 I/3,28	97,6 4 100 I/3,13	146 6 130 I/3,13	181 7 920 I/3,25	260 11 410 I/3,27	353 15 090 I/3,18	449 19 850 I/3,28	675 28 930 I/3,19	814 34 300 I/3,13	1 017 42 880 I/3,13	1 085 47 430 I/3,25	3,15	710		
2,8	-	-	-	-	-	-	72 3 000 I/2,75	95,3 4 080 I/2,82	128 5 450 I/2,81	161 6 900 I/2,83	268 11 460 I/2,82	333 14 310 I/2,83	496 21 170 I/2,81	626 26 810 I/2,82	798 34 030 I/2,81	998 42 540 I/2,81	1 122 48 180 I/2,83	2,8	630		

For n_1 lower than 560 min⁻¹ see page 107.

▲ Possible forced lubrication with heat exchanger: consult us.

7 - Selection tables (helical gear reducers)



$n_{N2} \cdot L_h$ min ⁻¹ · h	i_N	P_{N2} kW M_{N2} N m ... /i																i_N	n_1 min ⁻¹	n_{N2} min ⁻¹	
		50	63	64	80	81	100	125	140	160	180	200	225	250	280	320	321				360
2 800 000	2,5	-	8,23 355 1/2,53	-	17,8 740 1/2,44	-	30,2 1 320 1/2,55	71,2 3 070 1/2,53	92,8 4 000 1/2,53	114 4 750 1/2,44	143 6 090 1/2,5	236 10 300 1/2,55	295 12 200 1/2,43	461 19 910 1/2,53	631 27 200 1/2,53	826 34 450 1/2,44	1 033 43 060 1/2,44	1 147 48 890 1/2,5	2,5	560	224
		2 500 000	71	-	-	-	-	-	-	3 550 31/72,8	5 300 31/74,9	7 260 31/74,6	10 600 31/72,6	15 000 31/74,5	21 200 31/74,7	24 180 31/75,3	31 810 31/71	39 760 31/71	48 360 31/73		
63	-		270 31/60,1	335 31/62,6	580 31/66,3	670 31/66,3	1 180 31/61,5	2 360 31/60,2	3 550 31/62	5 300 31/63,5	7 500 31/63,8	10 600 31/62,6	15 000 31/61,7	21 200 31/61,5	24 760 31/62,7	35 690 31/67,1	44 610 31/67,1	48 240 31/66			
56	-		-	-	-	-	-	-	3 650 31/55,4	5 450 31/55,5	7 500 31/55,3	11 200 31/54,1	15 850 31/55,5	22 700 31/55,6	25 500 31/56	32 320 31/57,8	40 230 31/57,8	51 000 31/59,4			
50	-		280 31/49,4	355 31/51,5	600 31/49,8	710 31/49,8	1 250 31/51,2	2 380 31/49,5	3 750 31/50,4	5 600 31/50,8	7 750 31/51	11 200 31/52,6	15 500 31/51,8	22 400 31/51,7	25 410 31/52,7	35 450 31/52,9	44 320 31/52,9	50 820 31/52			
45	-		-	-	-	-	-	-	3 840 31/45,1	5 800 31/44,4	7 500 31/44,2	11 800 31/45,4	16 490 31/46,6	22 660 31/46,7	26 890 31/47,1	34 090 31/45,5	42 420 31/45,5	53 790 31/46,8			
40	-		300 31/40,8	370 31/42,5	600 31/43,6	710 31/43,6	1 320 31/39,1	2 410 31/40,8	3 410 31/38,7	6 080 31/38,5	7 010 31/39,9	12 200 31/41,5	14 800 31/40,4	21 330 31/42,4	27 760 31/41,2	35 190 31/40,7	43 800 31/40,7	55 530 31/42,3			
35,5	-		-	-	-	-	-	-	3 440 31/37,5	5 970 31/36,5	7 230 31/36,3	11 950 31/34,4	14 460 31/35,4	21 660 31/36,9	28 530 31/37,2	36 160 31/37,4	45 000 31/37,4	57 050 31/38,4			
31,5	-		300 31/33,5	335 31/34,9	655 31/32,8	770 31/32,8	1 280 31/32,6	2 190 31/33,5	3 370 31/32,2	5 370 31/31,6	7 000 31/32,8	11 330 31/31,5	14 850 31/30,6	21 200 31/33,5	29 280 31/32,5	37 120 31/33,5	46 190 31/33,5	58 560 31/34,7			
28	-		-	-	-	-	1 090 21/28,8	-	3 130 31/29,1	5 340 31/28,4	6 270 31/28,6	10 850 31/27,2	14 080 31/27,3	21 780 31/28,7	28 140 31/28,8	38 140 31/30	47 460 31/30	57 770 31/30,3			
25	125 21/24,4		285 21/24,1	335 21/25,1	505 21/26	595 21/26	1 250 21/23,7	2 460 21/24,1	3 450 21/24,1	5 400 21/24,6	7 840 21/25,4	10 900 21/24,2	14 990 21/25	22 440 21/25	29 760 21/24,6	31 500 21/25	46 250 21/25	52 590 21/25,7			
22,4	-		-	-	-	-	-	-	3 960 21/21,7	6 000 21/22,5	8 450 21/23,3	11 750 21/22,2	15 280 21/23	22 860 21/22	27 590 21/22,2	34 990 21/22,8	47 590 21/22,8	55 280 21/23,4			
20	145 21/20,1		330 21/19,3	365 21/20,1	600 21/20,8	705 21/20,8	1 390 21/19,3	2 780 21/19,3	4 190 21/19,6	6 450 21/20,7	8 070 21/20,8	12 160 21/20,3	15 280 21/20	24 630 21/19,7	29 690 21/20,1	37 630 21/20,6	48 590 21/20,6	59 500 21/20,3			
18	-		-	-	-	-	-	-	4 170 21/17,6	6 510 21/18,1	8 500 21/18	12 050 21/17,6	15 710 21/18,1	25 300 21/17,8	30 970 21/17,9	39 340 21/17,8	49 000 21/17,8	61 560 21/18,3			
16	170 21/16,3		340 21/15,8	415 21/16,5	710 21/15,7	840 21/15,7	1 440 21/16,1	2 710 21/15,8	3 810 21/15,1	6 900 21/15,7	8 120 21/16,6	12 220 21/16,1	15 470 21/15,6	23 830 21/16,2	29 210 21/15,7	41 310 21/15,9	51 630 21/15,9	60 430 21/16			
14	-		-	-	-	-	-	-	79,2 3 970 21/14,7	144 6 890 21/14,1	178 8 760 21/14,4	261 12 360 21/13,9	305 15 210 21/14,6	460 22 910 21/14,6	570 28 560 21/14,7	- 40 470 21/14,3	- 49 480 21/14,3	- 62 970 21/14,4	14	2800	200
12,5	3,63 170 21/12,3		6,75 335 21/13,1	7,07 370 21/13,6	11,7 610 21/13,7	13,5 710 21/13,7	29,4 1 380 21/12,3	57,2 2 850 21/13,1	84,5 4 300 21/13,3	124 6 460 21/13,6	157 8 210 21/13,6	244 12 090 21/13	318 15 500 21/12,8	507 25 290 21/13,1	603 30 690 21/13,3	- 38 820 21/13,4	- 49 240 21/13,4	- 61 450 21/13,1	12,5	2500	
11,2	-		-	-	-	-	-	-	83,9 4 260 21/11,9	130 6 600 21/11,9	175 8 830 21/11,8	250 11 920 21/11,2	330 16 180 21/11,5	507 25 550 21/11,8	630 31 960 21/11,9	- 41 800 21/11,5	- 52 250 21/11,5	- 63 950 21/11,8	11,2	2240	

For n_1 lower than 560 min⁻¹ see page 107.

▲ Possible forced lubrication with heat exchanger: consult us.

7 - Selection tables (helical gear reducers)



$n_{N2} \cdot L_h$ min ⁻¹ · h	i_N	P_{N2} kW																i_N	n_1	n_{N2} min ⁻¹	
		M_{N2} N m																			
		... / i																			
		50	63	64	80	81	100	125	140	160	180	200	225	250	280	320	321	360			
2 500 000	10	3,83 185 21/10,2	6,76 345 21/10,7	7,8 415 21/11,2	14,6 715 21/10,3	17,1 840 21/10,3	29 1 420 21/10,2	56,8 2 910 21/10,7	77,5 3 780 21/10,2	144 7 100 21/10,3	172 8 790 21/10,7	246 12 050 21/10,2	345 16 400 21/9,95	469 24 020 21/10,7	652 32 400 21/10,4	860 42 270 21/10,3▲	1 075 52 840 21/10,3▲	1 271 64 820 21/10,7▲	10	2000	200
	9	-	-	-	-	-	-	72 3 520 21/9,22	119 5 830 21/9,24	136 6 740 21/9,31	258 12 110 21/8,85	320 15 090 21/8,88	489 23 830 21/9,19	631 30 880 21/9,22	849 41 630 21/9,24	1 059 51 900 21/9,24	1 255 61 980 21/9,31	9	1800		
	8	3,42 165 21/8,01	6,93 340 21/8,26	8,67 415 21/7,99	15,7 755 21/8,03	19,3 925 21/8,03	29,6 1 410 21/8,01	58,6 2 890 21/8,26	-	123 5 890 21/8,03	-	252 12 030 21/8,01	-	490 24 170 21/8,26	-	881 42 220 21/8,03	1 098 52 630 21/8,03	-	8	1600	
	6,3	2,98 145 21/6,42	5,83 290 21/6,53	7,29 380 21/6,86	12,4 605 21/6,41	15,5 760 21/6,41	28,8 1 410 21/6,42	48,2 2 400 21/6,53	-	98,2 4 820 21/6,41	-	225 11 030 21/6,42	-	443 22 120 21/6,53	-	768 37 630 21/6,41	904 44 290 21/6,41	-	6,3	1250	
	5	-	6,07 290 1/5	-	11,6 580 1/5,2	-	26,8 1 230 1/4,82	52,6 2 510 1/5	71,5 3 420 1/5	115 5 400 1/4,92	150 7 260 1/5,07	232 10 900 1/4,92	289 14 000 1/5,07	380 18 420 1/5,08	586 28 000 1/5	774 36 390 1/4,92	968 45 490 1/4,92	1 039 50 300 1/5,07	5	1000	
	4,5	-	-	-	-	-	54,1 2 560 1/4,45	76 3 630 1/4,5	122 5 830 1/4,5	159 7 880 1/4,67	242 11 560 1/4,5	299 14 820 1/4,67	448 21 240 1/4,47	543 25 910 1/4,5	772 36 850 1/4,5	965 46 070 1/4,5	1 037 50 610 1/4,6	4,5	900		
	4	-	7,17 340 1/4	-	14,2 705 1/4,16	-	28,3 1 320 1/3,92	56,3 2 690 1/4	84 4 090 1/4,08	125 6 180 1/4,13	161 8 000 1/4,15	239 11 790 1/4,13	317 15 390 1/4,07	418 19 940 1/4	596 29 030 1/4,08	764 37 080 1/4,07	955 46 350 1/4,07	1 033 49 310 1/4	4	800	
	3,55	-	-	-	-	-	61,7 3 000 1/3,62	85,5 4 190 1/3,64	122 5 920 1/3,62	170 8 250 1/3,6	242 11 650 1/3,57	312 15 380 1/3,67	439 21 340 1/3,62	561 27 510 1/3,64	760 35 770 1/3,5	950 44 710 1/3,5	1 017 49 260 1/3,6	3,55	710		
	3,15	-	6,93 345 1/3,28	-	15,4 730 1/3,13	-	28,8 1 430 1/3,27	60,2 3 000 1/3,28	89,8 4 250 1/3,13	129 6 140 1/3,13	161 7 920 1/3,25	239 11 830 1/3,27	325 15 650 1/3,18	413 20 580 1/3,28	621 29 990 1/3,19	749 35 550 1/3,13	936 44 440 1/3,13	998 49 160 1/3,25	3,15	630	
	2,8	-	-	-	-	-	65,5 3 070 1/2,75	87,8 4 230 1/2,82	114 5 450 1/2,81	143 6 900 1/2,83	238 11 460 1/2,82	296 14 310 1/2,83	457 21 930 1/2,81	577 27 780 1/2,82	735 35 260 1/2,81	919 44 070 1/2,81	1 033 49 910 1/2,83	2,8	560		
2 240 000	80	-	225 31/75,2	280 31/78,2	485 31/82,7	560 31/82,7	1000 31/75,5	2 000 31/75,3	3 450 31/81,4	5 150 31/85,7	7 300 31/86,1	10 300 31/84	14 500 31/82,7	20 600 31/82,7	26 420 31/84,3	36 960 31/82,5	43 700 31/82,5	46 990 31/81,1			
	71	-	-	-	-	-	-	3 650 31/72,8	5 300 31/74,9	7 510 31/74,6	10 900 31/72,6	15 500 31/74,5	21 800 31/74,7	24 820 31/75,3	32 910 31/71	41 140 31/71	49 640 31/73				
	63	-	280 31/60,1	335 31/62,6	580 31/66,3	670 31/66,3	1 220 31/61,5	2 430 31/60,2	3 650 31/62	5 450 31/63,5	7 750 31/63,8	10 900 31/62,6	15 500 31/61,7	21 800 31/61,5	25 590 31/62,7	36 890 31/67,1	46 110 31/67,1	49 560 31/66			
	56	-	-	-	-	-	-	3 750 31/55,4	5 600 31/55,5	7 750 31/55,3	11 500 31/54,1	16 400 31/55,5	23 480 31/55,6	26 150 31/56	33 150 31/57,8	41 250 31/57,8	52 300 31/59,4				
	50	-	290 31/49,4	365 31/51,5	615 31/49,8	730 31/49,8	1 280 31/51,2	2 450 31/49,5	3 750 31/50,4	5 600 31/50,8	8 000 31/51	11 500 31/52,6	16 000 31/51,8	23 000 31/51,7	26 140 31/52,7	36 590 31/52,9	45 740 31/52,9	52 270 31/52			
	45	-	-	-	-	-	-	-	3 980 31/45,1	6 000 31/44,4	7 760 31/44,2	12 200 31/45,4	17 090 31/46,6	23 470 31/46,7	27 760 31/47,1	35 190 31/45,5	43 800 31/45,5	55 530 31/46,8			
	40	-	305 31/40,8	370 31/42,5	605 31/43,6	710 31/43,6	1 360 31/39,1	2 490 31/40,8	3 540 31/38,7	6 300 31/38,5	7 270 31/39,9	12 500 31/41,5	15 340 31/40,4	22 110 31/42,4	28 530 31/41,2	36 160 31/40,7	45 000 31/40,7	57 050 31/42,3			
35,5	-	-	-	-	-	-	-	3 560 31/37,5	6 190 31/36,5	7 420 31/36,3	12 380 31/34,4	14 850 31/35,4	22 450 31/36,9	29 280 31/37,2	37 120 31/37,4	46 190 31/37,4	58 560 31/38,4				

For n_1 lower than 560 min⁻¹ see page 107.

▲ Possible forced lubrication with heat exchanger: consult us.

7 - Selection tables (helical gear reducers)

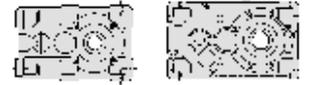

$n_{N2} \cdot L_h$ min ⁻¹ · h	i_N	P_{N2} kW																i_N	n_1 min ⁻¹	n_{N2} min ⁻¹	
		M_{N2} N m																			
		50	63	64	80	81	100	125	140	160	180	200	225	250	280	320	321				360
2 240 000	31,5	-	305 3/33,5	345 3/34,9	675 3/32,8	775 3/32,8	1 320 3/32,6	2 250 3/33,5	3 460 3/32,2	5 560 3/31,6	7 190 3/32,8	11 730 3/31,5	15 250 3/30,6	21 780 3/33,5	30 080 3/32,5	38 140 3/33,5	47 460 3/33,5	60 170 3/34,7			
	28	-	-	-	-	-	1 120 2/28,8	-	3 170 3/29,1	5 410 3/28,4	6 350 3/28,6	11 000 3/27,2	14 270 3/27,3	22 080 3/28,7	28 520 3/28,8	38 660 3/30	48 100 3/30	58 560 3/30,3			
	25	125 2/24,4	285 2/24,1	335 2/25,1	510 2/26	600 2/26	1 300 2/23,7	2 470 2/24,1	3 460 2/24,1	5 420 2/24,6	7 870 2/25,4	10 930 2/24,2	15 470 2/25	22 520 2/25	30 260 2/24,6	31 900 2/25	46 410 2/25	54 280 2/25,7			
	22,4	-	-	-	-	-	-	-	3 970 2/21,7	6 180 2/22,5	8 730 2/23,3	11 790 2/22,2	15 830 2/23	22 950 2/22	27 980 2/22,2	35 480 2/22,8	47 770 2/22,8	56 060 2/23,4			
	20	145 2/20,1	340 2/19,3	370 2/20,1	605 2/20,8	710 2/20,8	1 440 2/19,3	2 880 2/19,3	4 310 2/19,6	6 470 2/20,7	8 360 2/20,8	12 610 2/20,3	15 840 2/20	25 530 2/19,7	30 110 2/20,1	38 170 2/20,6	50 360 2/20,6	60 420 2/20,3			
	18	-	-	-	-	-	-	-	4 330 2/17,6	6 750 2/18,1	8 500 2/18	12 490 2/17,6	15 930 2/18,1	26 220 2/17,8	31 410 2/17,9	39 900 2/17,8	49 700 2/17,8	62 450 2/18,3			
	16	3,07 170 2/16,3	6,5 350 2/15,8	7,42 420 2/16,5	13,4 715 2/15,7	15,8 845 2/15,7	27,1 1 490 2/16,1	51,9 2 800 2/15,8	76,8 3 950 2/15,1	129 6 900 2/15,7	148 8 410 2/16,6	231 12 660 2/16,1	301 16 030 2/15,6	447 24 690 2/16,2	553 29 620 2/15,7	-	-	-	16	2800	180
	14	-	-	-	-	-	-	-	71 3 980 2/14,7	128 6 900 2/14,1	165 9 060 2/14,4	241 12 780 2/13,9	282 15 730 2/14,6	412 22 990 2/14,6	515 28 950 2/14,7	-	-	-	14	2500	
	12,5	3,26 170 2/12,3	6,25 350 2/13,1	6,36 370 2/13,6	10,6 620 2/13,7	12,2 715 2/13,7	27,2 1 430 2/12,3	52,9 2 950 2/13,1	76 4 320 2/13,3	112 6 480 2/13,6	146 8 480 2/13,6	226 12 490 2/13	289 15 710 2/12,8	463 25 800 2/13,1	548 31 100 2/13,3	-	-	-	12,5	2240	
	11,2	-	-	-	-	-	-	-	77,5 4 400 2/11,9	120 6 820 2/11,9	162 9 140 2/11,8	231 12 330 2/11,2	299 16 400 2/11,5	468 26 390 2/11,8	570 32 400 2/11,9	764 41 950 2/11,5	955 52 440 2/11,5	1 148 64 820 2/11,8	11,2	2000	
	10	3,54 190 2/10,2	6,28 360 2/10,7	7,04 420 2/11,2	13,1 720 2/10,3	15,5 845 2/10,3	26,9 1 460 2/10,2	52,8 3 010 2/10,7	72 3 900 2/10,2	132 7 190 2/10,3	160 9 070 2/10,7	229 12 430 2/10,2	315 16 610 2/9,95	435 24 790 2/10,7	594 32 810 2/10,4	799 43 630 2/10,3	998 54 530 2/10,3	1 159 65 640 2/10,7	10	1800	
	9	-	-	-	-	-	-	-	66,3 3 650 2/9,22	107 5 910 2/9,24	123 6 830 2/9,31	238 12 540 2/8,85	289 15 320 2/8,88	441 24 170 2/9,19	569 31 320 2/9,22	769 42 420 2/9,24	961 53 020 2/9,24	1 131 62 850 2/9,31	9	1600	
	8	3,12 170 2/8,01	6,32 355 2/8,26	7,89 430 2/7,99	13,8 755 2/8,03	17 935 2/8,03	26,9 1 470 2/8,01	53,4 3 010 2/8,26	-	5 990 2/8,03	109	12 480 2/8,01	-	436 24 560 2/8,26	-	783 42 900 2/8,03	976 53 480 2/8,03	-	8	1400	
	6,3	2,68 145 2/6,42	5,4 300 2/6,53	6,75 395 2/6,86	11,1 610 2/6,41	13,9 760 2/6,41	26,7 1 460 2/6,42	43,4 2 420 2/6,53	-	88,6 4 850 2/6,41	-	203 11 100 2/6,42	-	399 22 250 2/6,53	-	694 37 980 2/6,41	815 44 570 2/6,41	-	6,3	1120	
	5	-	5,47 290 1/5	-	10,5 580 1/5,2	-	24,2 1 240 1/4,82	47,5 2 520 1/5	64,4 3 420 1/5	104 5 420 1/4,92	135 7 260 1/5,07	209 10 940 1/4,92	260 14 000 1/5,07	353 19 010 1/5,08	528 28 000 1/5	710 37 110 1/4,92	888 46 390 1/4,92	965 51 920 1/5,07	5	900	
	4,5	-	-	-	-	-	-	48,3 2 570 1/4,45	67,5 3 630 1/4,5	109 5 860 1/4,5	141 7 880 1/4,67	220 11 800 1/4,5	275 15 330 1/4,67	413 22 010 1/4,47	500 26 840 1/4,5	711 38 180 1/4,5	888 47 720 1/4,5	955 52 430 1/4,6	4,5	800	
4	-	6,36 340 1/4	-	12,7 710 1/4,16	-	26 1 370 1/3,92	51,8 2 790 1/4	74,8 4 100 1/4,08	112 6 200 1/4,13	148 8 290 1/4,15	220 12 220 1/4,13	291 15 950 1/4,07	384 20 660 1/4	549 30 080 1/4,08	703 38 430 1/4,07	878 48 040 1/4,07	950 51 100 1/4	4	710		
3,55	-	-	-	-	-	-	55,6 3 050 1/3,62	78,4 4 330 1/3,64	112 6 130 1/3,62	151 8 250 1/3,6	223 12 070 1/3,57	287 15 950 1/3,67	404 22 120 1/3,62	516 28 510 1/3,64	699 37 080 1/3,5	874 46 350 1/3,5	936 51 060 1/3,6	3,55	630		

For n_1 lower than 560 min⁻¹ see page 107.

▲ Possible forced lubrication with heat exchanger: consult us.

7 - Selection tables (helical gear reducers)



$n_{N2} \cdot L_h$ min ⁻¹ · h	i_N	P_{N2} kW																i_N	n_1 min ⁻¹	n_{N2} min ⁻¹	
		M_{N2} N m																			
		... / i																			
		50	63	64	80	81	100	125	140	160	180	200	225	250	280	320	321	360			
2 240 000	3,15	-	6,34 355 1/3,28	-	14 750 1/3,13	-	25,6 1 430 1/3,27	54,8 3 070 1/3,28	82,7 4 410 1/3,13	115 6 140 1/3,13	143 7 920 1/3,25	220 12 250 1/3,27	295 16 000 1/3,18	380 21 320 1/3,28	571 31 060 1/3,19	689 36 830 1/3,13	862 46 040 1/3,13	919 50 930 1/3,25	3,15	560	180
2 000 000	90	-	-	-	-	-	-	3 550 3/89,4	5 300 3/93,7	6 900 3/93,3	10 600 3/86,4	15 000 3/88,8	21 200 3/89	25 180 3/89,7	34 180 3/90,1	42 730 3/90,1	48 360 3/92,7				
	80	-	230 3/75,2	290 3/78,2	500 3/82,7	580 3/82,7	1 030 3/75,5	2 060 3/75,3	3 550 3/81,4	5 300 3/85,7	7 500 3/86,1	10 600 3/84	15 000 3/82,7	21 200 3/82,7	27 330 3/84,3	37 500 3/82,5	45 000 3/82,5	48 240 3/81,1			
	71	-	-	-	-	-	-	-	3 750 3/72,8	5 450 3/74,9	7 760 3/74,6	11 200 3/72,6	16 000 3/74,5	22 400 3/74,7	25 500 3/75,3	34 010 3/71	42 520 3/71	51 000 3/73			
	63	-	280 3/60,1	345 3/62,6	605 3/66,3	710 3/66,3	1 250 3/61,5	2 500 3/60,2	3 750 3/62	5 600 3/63,5	7 750 3/63,8	11 200 3/62,6	15 500 3/61,7	22 400 3/61,5	26 480 3/62,7	38 160 3/67,1	47 700 3/67,1	50 820 3/66			
	56	-	-	-	-	-	-	-	3 870 3/55,4	5 800 3/55,5	8 000 3/55,3	11 800 3/54,1	16 930 3/55,5	24 240 3/55,6	26 890 3/56	34 090 3/57,8	42 420 3/57,8	53 790 3/59,4			
	50	-	300 3/49,4	385 3/51,5	630 3/49,8	775 3/49,8	1 320 3/51,2	2 540 3/49,5	3 870 3/50,4	5 800 3/50,8	8 250 3/51	11 800 3/52,6	16 500 3/51,8	23 600 3/51,7	26 980 3/52,7	37 910 3/52,9	47 390 3/52,9	53 960 3/52			
	45	-	-	-	-	-	-	-	4 130 3/45,1	6 150 3/44,4	8 050 3/44,2	12 500 3/45,4	17 710 3/46,6	24 330 3/46,7	28 530 3/47,1	36 160 3/45,5	45 000 3/45,5	57 050 3/46,8			
	40	-	315 3/40,8	370 3/42,5	605 3/43,6	715 3/43,6	1 400 3/39,1	2 580 3/40,8	3 670 3/38,7	6 300 3/38,5	7 530 3/39,9	12 800 3/41,5	15 900 3/40,4	22 920 3/42,4	29 280 3/41,2	37 120 3/40,7	46 190 3/40,7	58 560 3/42,3			
	35,5	-	-	-	-	-	-	-	3 690 3/37,5	6 420 3/36,5	7 630 3/36,3	12 830 3/34,4	15 250 3/35,4	23 250 3/36,9	30 080 3/37,2	38 140 3/37,4	47 460 3/37,4	60 170 3/38,4			
	31,5	-	315 3/33,5	355 3/34,9	700 3/32,8	775 3/32,8	1 360 3/32,6	2 280 3/33,5	3 510 3/32,2	5 750 3/31,6	7 290 3/32,8	12 140 3/31,5	15 460 3/30,6	22 080 3/33,5	30 490 3/32,5	38 660 3/33,5	48 100 3/33,5	60 990 3/34,7			
	28	-	-	-	-	-	1 120 2/28,8	-	3 210 3/29,1	5 480 3/28,4	6 430 3/28,6	11 130 3/27,2	14 450 3/27,3	22 360 3/28,7	28 880 3/28,8	39 140 3/30	48 710 3/30	59 300 3/30,3			
	25	125 2/24,4	290 2/24,1	340 2/25,1	510 2/26	600 2/26	1 300 2/23,7	2 480 2/24,1	3 470 2/24,1	5 440 2/24,6	7 900 2/25,4	10 980 2/24,2	15 820 2/25	22 600 2/25	30 370 2/24,6	32 350 2/25	46 580 2/25	56 240 2/25,7			
	22,4	-	-	-	-	-	-	-	3 990 2/21,7	6 200 2/22,5	8 760 2/23,3	11 840 2/22,2	16 410 2/23	23 030 2/22	28 720 2/22,2	35 990 2/22,8	47 950 2/22,8	56 960 2/23,4			
	20	145 2/20,1	350 2/19,3	370 2/20,1	605 2/20,8	710 2/20,8	1 490 2/19,3	2 970 2/19,3	4 320 2/19,6	6 500 2/20,7	8 670 2/20,8	12 890 2/20,3	16 420 2/20	25 850 2/19,7	30 980 2/20,1	38 720 2/20,6	52 200 2/20,6	62 630 2/20,3			
	18	-	-	-	-	-	-	-	74,9 4 480 2/17,6	113 6 990 2/18,1	143 8 750 2/18	216 12 940 2/17,6	266 16 390 2/18,1	436 26 450 2/17,8	521 31 860 2/17,9	- 40 470 2/17,8	- 50 470 2/17,8	- 63 330 2/18,3	18	2800	160
	16	2,75 170 2/16,3	6,01 365 2/15,8	6,65 420 2/16,5	12 715 2/15,7	14,1 845 2/15,7	25,1 1 540 2/16,1	48 2 900 2/15,8	71 4 080 2/15,1	119 7 100 2/15,7	137 8 700 2/16,6	213 13 100 2/16,1	278 16 580 2/15,6	413 25 540 2/16,2	501 30 020 2/15,7	- 44 270 2/15,9	- 55 340 2/15,9	- 62 520 2/16	16	2500	
14	-	-	-	-	-	-	-	63,8 4 000 2/14,7	115 6 900 2/14,1	153 9 360 2/14,4	223 13 210 2/13,9	261 16 260 2/14,6	371 23 070 2/14,6	469 29 400 2/14,7	- 41 560 2/14,3	- 51 340 2/14,3	- 64 670 2/14,4	14	2240		

For n_1 lower than 560 min⁻¹ see page 107.

7 - Selection tables (helical gear reducers)

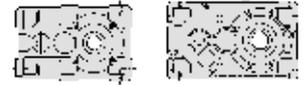

$n_{N2} \cdot L_h$ min ⁻¹ · h	i_N	P_{N2} kW M_{N2} N m ... /i																i_N	n_1 min ⁻¹	n_{N2}	
		50	63	64	80	81	100	125	140	160	180	200	225	250	280	320	321				360
2 000 000	12,5	2,92 170 21/12,3	5,7 355 21/13,1	5,7 370 21/13,6	9,58 625 21/13,7	11,1 725 21/13,7	25,1 1 480 21/12,3	47,6 2 970 21/13,1	68,1 4 330 21/13,3	100 6 500 21/13,6	134 8 760 21/13,6	208 12 890 21/13	266 16 200 21/12,8	415 25 890 21/13,1	498 31 700 21/13,3	625 39 870 21/13,4▲	825 52 650 21/13,4▲	1 006 63 100 21/13,1▲	12,5	2000	160
	11,2	-	-	-	-	-	-	71,7 4 530 21/11,9	112 7 040 21/11,9	150 9 430 21/11,8	214 12 720 21/11,2	272 16 610 21/11,5	423 26 480 21/11,8	520 32 810 21/11,9	690 42 090 21/11,5	862 52 610 21/11,5	1 046 65 640 21/11,8	11,2	1800		
	10	3,16 195 21/10,2	5,79 370 21/10,7	6,29 420 21/11,2	11,7 720 21/10,3	13,8 850 21/10,3	24,8 1 510 21/10,2	48,6 3 120 21/10,7	66,3 4 040 21/10,2	118 7 220 21/10,3	147 9 400 21/10,7	211 12 880 21/10,2	284 16 840 21/9,95	401 25 690 21/10,7	535 33 270 21/10,4	736 45 200 21/10,3	919 56 500 21/10,3	1 044 66 570 21/10,7	10	1600	
	9	-	-	-	-	-	-	-	60,4 3 800 21/9,22	95,3 6 010 21/9,24	109 6 940 21/9,31	216 13 060 21/8,85	263 15 950 21/8,88	392 24 560 21/9,19	506 31 820 21/9,22	700 44 150 21/9,24	876 55 190 21/9,24	1 006 63 860 21/9,31	9	1400	
	8	2,88 175 21/8,01	5,83 370 21/8,26	7,29 445 21/7,99	12,4 760 21/8,03	15,3 935 21/8,03	24,9 1 520 21/8,01	49,3 3 110 21/8,26	-	98,2 6 030 21/8,03	-	211 12 910 21/8,01	-	391 24 710 21/8,26	-	704 43 180 21/8,03	877 53 810 21/8,03	-	8	1250	
	6,3	2,4 145 21/6,42	4,99 310 21/6,53	6,24 410 21/6,86	9,97 610 21/6,41	12,5 765 21/6,41	24,7 1 510 21/6,42	39 2 430 21/6,53	-	79,6 4 880 21/6,41	-	182 11 160 21/6,42	-	359 22 380 21/6,53	-	626 38 340 21/6,41	732 44 850 21/6,41	-	6,3	1000	
	5	-	5,05 300 1/5	-	9,39 585 1/5,2	-	21,6 1 240 1/4,82	42,4 2 530 1/5	57,2 3 420 1/5	92,6 5 440 1/4,92	120 7 260 1/5,07	187 10 980 1/4,92	231 14 000 1/5,07	325 19 690 1/5,08	469 28 000 1/5	634 37 250 1/4,92	792 46 560 1/4,92	888 53 780 1/5,07	5	800	
	4,5	-	-	-	-	-	-	42,9 2 570 1/4,45	59,9 3 630 1/4,5	97,1 5 880 1/4,5	126 7 880 1/4,67	195 11 800 1/4,5	244 15 330 1/4,67	378 22 730 1/4,47	460 27 820 1/4,5	633 38 340 1/4,5	792 47 920 1/4,5	878 54 340 1/4,6	4,5	710	
	4	-	5,64 340 1/4	-	11,2 710 1/4,16	-	23,5 1 400 1/3,92	46,2 2 800 1/4	66,6 4 120 1/4,08	99,4 6 230 1/4,13	136 8 590 1/4,15	200 12 500 1/4,13	268 16 530 1/4,07	353 21 420 1/4	505 31 180 1/4,08	646 39 830 1/4,07	808 49 790 1/4,07	874 52 970 1/4	4	630	
	3,55	-	-	-	-	-	-	49,6 3 060 1/3,62	69,9 4 340 1/3,64	103 6 350 1/3,62	134 8 250 1/3,6	205 12 510 1/3,57	264 16 500 1/3,67	372 22 920 1/3,62	476 29 540 1/3,64	644 38 410 1/3,5	804 48 010 1/3,5	862 52 900 1/3,6	3,55	560	
1 800 000	100	-	-	-	-	-	1 150 31/103	2 300 31/101	3 450 31/100	5 150 31/107	7 300 31/108	10 300 31/100	14 500 31/98,5	20 600 31/98,5	28 180 31/100	36 500 31/105	43 700 31/105	48 830 31/103			
	90	-	-	-	-	-	-	-	3 650 31/89,4	5 300 31/93,7	7 100 31/93,3	10 900 31/86,4	15 500 31/88,8	21 800 31/89	26 050 31/89,7	35 360 31/90,1	44 200 31/90,1	49 640 31/92,7			
	80	-	235 31/75,2	290 31/78,2	510 31/82,7	580 31/82,7	1 060 31/75,5	2 120 31/75,3	3 650 31/81,4	5 450 31/85,7	7 750 31/86,1	10 900 31/84	15 500 31/82,7	21 800 31/82,7	28 250 31/84,3	38 700 31/82,5	46 200 31/82,5	49 560 31/81,1			
	71	-	-	-	-	-	-	-	3 870 31/72,8	5 600 31/74,9	8 030 31/74,6	11 500 31/72,6	16 000 31/74,5	23 000 31/74,7	26 150 31/75,3	35 190 31/71	43 990 31/71	52 300 31/73			
	63	-	290 31/60,1	355 31/62,6	610 31/66,3	715 31/66,3	1 280 31/61,5	2 570 31/60,2	3 750 31/62	5 600 31/63,5	8 000 31/63,8	11 500 31/62,6	16 000 31/61,7	23 000 31/61,5	27 330 31/62,7	39 390 31/67,1	49 230 31/67,1	52 270 31/66			
	56	-	-	-	-	-	-	-	4 000 31/55,4	6 000 31/55,5	8 320 31/55,3	12 200 31/54,1	17 540 31/55,5	25 110 31/55,6	27 760 31/56	35 190 31/57,8	43 900 31/57,8	55 530 31/59,4			
	50	-	305 31/49,4	385 31/51,5	650 31/49,8	775 31/49,8	1 360 31/51,2	2 640 31/49,5	4 000 31/50,4	6 000 31/50,8	8 780 31/51	12 200 31/52,6	17 000 31/51,8	24 300 31/51,7	27 720 31/52,7	39 290 31/52,9	49 110 31/52,9	55 440 31/52			
	45	-	-	-	-	-	-	-	4 280 31/45,1	6 300 31/44,4	8 340 31/44,2	12 800 31/45,4	18 360 31/46,6	25 220 31/46,7	29 280 31/47,1	37 120 31/45,5	46 190 31/45,5	58 560 31/46,8			

For n_1 lower than 560 min⁻¹ see page 107.

▲ Possible forced lubrication with heat exchanger: consult us.

7 - Selection tables (helical gear reducers)



$n_{N2} \cdot L_h$ min ⁻¹ · h	i_N	P_{N2} kW M_{N2} N m ... / i																i_N	n_1 min ⁻¹	n_{N2} min ⁻¹	
		50	63	64	80	81	100	125	140	160	180	200	225	250	280	320	321				360
1 800 000	40	–	325 3I/40,8	370 3I/42,5	610 3I/43,6	715 3I/43,6	1 450 3I/39,1	2 680 3I/40,8	3 800 3I/38,7	6 500 3I/38,5	7 800 3I/39,9	13 200 3I/41,5	16 480 3I/40,4	23 740 3I/42,4	30 080 3I/41,2	38 140 3I/40,7	47 460 3I/40,7	60 170 3I/42,3			
	35,5	–	–	–	–	–	–	–	3 820 3I/37,5	6 640 3I/36,5	7 730 3I/36,3	13 270 3I/34,4	15 460 3I/35,4	24 060 3I/36,9	30 490 3I/37,2	38 660 3I/37,4	48 100 3I/37,4	60 990 3I/38,4			
	31,5	–	315 3I/33,5	355 3I/34,9	720 3I/32,8	800 3I/32,8	1 360 3I/32,6	2 350 3I/33,5	3 550 3I/32,2	5 940 3I/31,6	7 380 3I/32,8	12 530 3I/31,5	15 660 3I/30,6	22 570 3I/33,5	30 880 3I/32,5	39 140 3I/33,5	48 710 3I/33,5	61 760 3I/34,7			
	28	–	–	–	–	–	1 150 2I/28,8	–	3 260 3I/29,1	5 560 3I/28,4	6 530 3I/28,6	11 290 3I/27,2	14 660 3I/27,3	22 670 3I/28,7	29 290 3I/28,8	39 700 3I/30	49 400 3I/30	60 140 3I/30,3			
	25	125 2I/24,4	290 2I/24,1	340 2I/25,1	510 2I/26	605 2I/26	1 300 2I/23,7	2 480 2I/24,1	3 480 2I/24,1	5 460 2I/24,6	7 930 2I/25,4	11 020 2I/24,2	15 880 2I/25	22 690 2I/25	30 480 2I/24,6	32 810 2I/25	46 760 2I/25	58 290 2I/25,7			
	22,4	–	–	–	–	–	–	–	4 000 2I/21,7	6 230 2I/22,5	8 790 2I/23,3	11 880 2I/22,2	17 010 2I/23	23 120 2I/22	29 770 2I/22,2	36 510 2I/22,8	48 130 2I/22,8	59 040 2I/23,4			
	20	2,13 145 2I/20,1	5,42 355 2I/19,3	5,42 370 2I/20,1	8,57 610 2I/20,8	10,1 715 2I/20,8	23 1 520 2I/19,3	45,3 2 980 2I/19,3	64,8 4 340 2I/19,6	92,5 6 520 2I/20,7	124 8 790 2I/20,8	186 12 940 2I/20,3	249 17 010 2I/20	386 25 950 2I/19,7	469 32 100 2I/20,1	– 39 270 2I/20,6	– 54 080 2I/20,6	– 64 880 2I/20,3	20	2800	140
	18	–	–	–	–	–	–	–	67,6 4 530 2I/17,6	103 7 100 2I/18,1	127 8 750 2I/18	199 13 390 2I/17,6	246 16 960 2I/18,1	390 26 540 2I/17,8	471 32 290 2I/17,9	– 41 770 2I/17,8	– 52 210 2I/17,8	– 64 190 2I/18,3	18	2500	
	16	2,47 170 2I/16,3	5,26 355 2I/15,8	5,98 420 2I/16,5	10,8 720 2I/15,7	12,7 850 2I/15,7	23,2 1 590 2I/16,1	44,4 3 000 2I/15,8	63,9 4 100 2I/15,1	108 7 240 2I/15,7	124 8 790 2I/16,6	197 13 540 2I/16,1	257 17 140 2I/15,6	383 26 400 2I/16,2	455 30 420 2I/15,7	– 45 760 2I/15,9	– 57 190 2I/15,9	– 64 610 2I/16	16	2240	
	14	–	–	–	–	–	–	–	57,2 4 010 2I/14,7	106 7 130 2I/14,1	141 9 670 2I/14,4	206 13 670 2I/13,9	241 16 820 2I/14,6	332 23 150 2I/14,6	433 30 420 2I/14,7	623 42 490 2I/14,3	779 53 110 2I/14,3	953 65 550 2I/14,4	14	2000	
	12,5	2,64 170 2I/12,3	5,14 355 2I/13,1	5,15 370 2I/13,6	8,73 635 2I/13,7	10,1 735 2I/13,7	23,3 1 520 2I/12,3	43 2 980 2I/13,1	61,5 4 350 2I/13,3	90,6 6 530 2I/13,6	121 8 790 2I/13,6	188 12 930 2I/13	247 16 720 2I/12,8	375 25 980 2I/13,1	463 32 720 2I/13,3	569 40 370 2I/13,4	766 54 340 2I/13,4	933 65 080 2I/13,1	12,5	1800	
	11,2	–	–	–	–	–	–	–	64 4 540 2I/11,9	100 7 100 2I/11,9	137 9 680 2I/11,8	197 13 180 2I/11,2	246 16 840 2I/11,5	377 26 570 2I/11,8	468 33 270 2I/11,9	615 42 250 2I/11,5	769 52 810 2I/11,5	943 66 570 2I/11,8	11,2	1600	
	10	2,77 195 2I/10,2	5,12 375 2I/10,7	5,52 420 2I/11,2	10,3 725 2I/10,3	12,1 850 2I/10,3	22,6 1 580 2I/10,2	44,3 3 240 2I/10,7	60,4 4 200 2I/10,2	103 7 250 2I/10,3	134 9 780 2I/10,7	192 13 410 2I/10,2	252 17 110 2I/9,95	365 26 730 2I/10,7	476 33 810 2I/10,4	670 47 040 2I/10,3	837 58 810 2I/10,3	929 67 640 2I/10,7	10	1400	
	9	–	–	–	–	–	–	–	55,8 3 930 2I/9,22	85,6 6 040 2I/9,24	98,2 6 990 2I/9,31	200 13 510 2I/8,85	243 16 500 2I/8,88	352 24 710 2I/9,19	454 32 020 2I/9,22	647 45 680 2I/9,24	809 57 100 2I/9,24	904 64 280 2I/9,31	9	1250	
	8	2,67 180 2I/8,01	5,4 380 2I/8,26	6,75 460 2I/7,99	11,1 760 2I/8,03	13,7 940 2I/8,03	23 1 570 2I/8,01	45,7 3 220 2I/8,26	–	88,6 6 070 2I/8,03	–	195 13 340 2I/8,01	–	353 24 850 2I/8,26	–	634 43 440 2I/8,03	790 54 130 2I/8,03	–	8	1120	
	6,3	2,17 150 2I/6,42	4,64 320 2I/6,53	5,66 410 2I/6,86	9 615 2I/6,41	11,3 765 2I/6,41	22 1 500 2I/6,42	35,3 2 450 2I/6,53	–	72,1 4 910 2I/6,41	–	165 11 230 2I/6,42	–	325 22 500 2I/6,53	–	568 38 670 2I/6,41	663 45 120 2I/6,41	–	6,3	900	
	5	–	4,5 300 I/5	–	8,36 585 I/5,2	–	19,2 1 250 I/4,82	37,7 2 540 I/5	50,8 3 420 I/5	82,3 5 450 I/4,92	106 7 260 I/5,07	166 11 020 I/4,92	205 14 000 I/5,07	299 20 410 I/5,08	416 28 000 I/5	565 37 390 I/4,92	706 46 730 I/4,92	817 55 740 I/5,07	5	710	
4,5	–	–	–	–	–	–	–	38,1 2 570 I/4,45	53,2 3 630 I/4,5	86,5 5 900 I/4,5	111 7 880 I/4,67	173 11 800 I/4,5	217 15 330 I/4,67	337 22 810 I/4,47	423 28 840 I/4,5	564 38 480 I/4,5	705 48 100 I/4,5	808 56 320 I/4,6	4,5	630	

For n_1 lower than 560 min⁻¹ see page 107.

7 - Selection tables (helical gear reducers)



$n_{N2} \cdot L_h$ min ⁻¹ · h	i_N	P_{N2} kW																i_N	n_1 min ⁻¹	n_{N2} min ⁻¹	
		M_{N2} N m																			
		50	63	64	80	81	100	125	140	160	180	200	225	250	280	320	321				360
1 800 000	4	-	5,02 340 1/4	-	9,99 710 1/4,16	-	20,9 1 400 1/3,92	41 2 800 1/4	59,3 4 120 1/4,08	88,7 6 250 1/4,13	122 8 620 1/4,15	177 12 500 1/4,13	247 17 130 1/4,07	325 22 190 1/4	465 32 300 1/4,08	595 41 270 1/4,07	744 51 580 1/4,07	804 54 870 1/4	4	560	140
1 600 000	100	-	-	-	-	-	1 180 31/103	2 360 31/101	3 550 31/100	5 300 31/107	7 500 31/108	10 600 31/100	15 000 31/98,5	21 200 31/98,5	29 150 31/100	37 500 31/105	45 000 31/105	50 520 31/103			
	90	-	-	-	-	-	-	-	3 750 31/89,4	5 450 31/93,7	7 300 31/93,3	11 200 31/86,4	16 000 31/88,8	22 400 31/89	26 920 31/89,7	36 550 31/90,1	45 680 31/90,1	51 000 31/92,7			
	80	-	245 31/75,2	300 31/78,2	515 31/82,7	605 31/82,7	1 090 31/75,5	2 180 31/75,3	3 750 31/81,4	5 600 31/85,7	7 750 31/86,1	11 200 31/84	15 500 31/82,7	22 400 31/82,7	29 230 31/84,3	38 700 31/82,5	47 500 31/82,5	50 820 31/81,1			
	71	-	-	-	-	-	-	-	3 870 31/72,8	5 800 31/74,9	8 290 31/74,6	11 800 31/72,6	16 500 31/74,5	23 600 31/74,7	26 950 31/75,3	36 320 31/71	45 400 31/71	53 790 31/73			
	63	-	300 31/60,1	370 31/62,6	610 31/66,3	715 31/66,3	1 320 31/61,5	2 650 31/60,2	3 870 31/62	5 800 31/63,5	8 250 31/63,8	11 800 31/62,6	16 500 31/61,7	23 600 31/61,5	28 310 31/62,7	40 800 31/61,1	51 010 31/61,1	53 960 31/66			
	56	-	-	-	-	-	-	-	4 120 31/55,4	6 150 31/55,5	8 360 31/55,3	12 500 31/54,1	17 500 31/55,5	25 000 31/55,6	28 530 31/56	36 400 31/57,8	45 500 31/57,8	57 050 31/59,4			
	50	-	315 31/49,4	400 31/51,5	670 31/49,8	800 31/49,8	1 400 31/51,2	2 730 31/49,5	4 120 31/50,4	6 150 31/50,8	8 810 31/51	12 500 31/52,6	17 500 31/51,8	25 000 31/51,7	28 460 31/52,7	40 730 31/52,9	50 910 31/52,9	56 910 31/52			
	45	-	-	-	-	-	-	-	4 430 31/45,1	6 500 31/44,4	8 640 31/44,2	13 200 31/45,4	19 020 31/46,6	26 120 31/46,7	30 080 31/47,1	38 140 31/45,5	47 460 31/45,5	60 170 31/46,8			
	40	-	335 31/40,8	375 31/42,5	610 31/43,6	720 31/43,6	1 450 31/39,1	2 770 31/40,8	3 930 31/38,7	6 700 31/38,5	8 070 31/39,9	13 600 31/41,5	17 040 31/40,4	24 560 31/42,4	30 490 31/41,2	38 660 31/40,7	48 100 31/40,7	60 990 31/42,3			
	35,5	-	-	-	-	-	-	-	3 940 31/37,5	6 700 31/36,5	7 830 31/36,3	13 700 31/34,4	15 660 31/35,4	24 830 31/36,9	30 880 31/37,2	39 140 31/37,4	48 710 31/37,4	61 760 31/38,4			
	31,5	-	325 31/33,5	365 31/34,9	725 31/32,8	800 31/32,8	1 360 31/32,6	2 430 31/33,5	3 600 31/32,2	6 150 31/31,6	7 490 31/32,8	12 980 31/31,5	15 880 31/30,6	23 380 31/33,5	31 320 31/32,5	39 700 31/33,5	49 400 31/33,5	62 640 31/34,7			
	28	-	-	-	-	-	1 150 21/28,8	-	3 300 31/29,1	5 640 31/28,4	6 620 31/28,6	11 630 31/27,2	14 870 31/27,3	23 000 31/28,7	29 710 31/28,8	40 270 31/30	50 110 31/30	61 000 31/30,3			
	25	125 21/24,4	290 21/24,1	340 21/25,1	520 21/26	605 21/26	1 310 21/23,7	2 490 21/24,1	3 500 21/24,1	5 480 21/24,6	7 960 21/25,4	11 060 21/24,2	15 940 21/25	22 770 21/25	30 600 21/24,6	33 280 21/25	46 930 21/25	60 410 21/25,7			
	22,4	-	-	-	-	-	-	-	54,4 4 020 21/21,7	81,5 6 250 21/22,5	111 8 830 21/23,3	158 11 930 21/22,2	220 17 270 21/23	309 23 210 21/22	408 30 840 21/22,2	- 37 030 21/22,8	- 48 310 21/22,8	- 61 170 21/23,4	22,4	2800	125
	20	1,91 145 21/20,1	4,85 355 21/19,3	4,86 370 21/20,1	7,75 615 21/20,8	9,02 720 21/20,8	20,6 1 520 21/19,3	40,6 2 990 21/19,3	58 4 350 21/19,6	82,9 6 540 21/20,7	111 8 820 21/20,8	167 12 980 21/20,3	230 17 600 21/20	346 26 040 21/19,7	433 33 210 21/20,1	- 39 810 21/20,6	- 55 950 21/20,6	- 67 130 21/20,3	20	2500	
	18	-	-	-	-	-	-	-	60,8 4 550 21/17,6	92,4 7 120 21/18,1	114 8 750 21/18	184 13 800 21/17,6	228 17 520 21/18,1	351 26 640 21/17,8	428 32 720 21/17,9	- 42 380 21/17,8	- 52 970 21/17,8	- 65 710 21/18,3	18	2240	
	16	2,22 175 21/16,3	4,83 365 21/15,8	5,35 420 21/16,5	9,64 720 21/15,7	11,4 855 21/15,7	20,8 1 600 21/16,1	41 3 100 21/15,8	57,3 4 120 21/15,1	97,1 7 270 21/15,7	111 8 820 21/16,6	182 14 010 21/16,1	237 17 730 21/15,6	354 27 310 21/16,2	411 30 830 21/15,7	623 47 340 21/15,9	779 59 170 21/15,9	875 66 850 21/16	16	2000	

For n_1 lower than 560 min⁻¹ see page 107.

7 - Selection tables (helical gear reducers)



$n_{N2} \cdot L_h$ min ⁻¹ · h	i_N	P_{N2} kW																i_N	n_1	n_{N2}	
		50	63	64	80	81	100	125	140	160	180	200	225	250	280	320	321				360
1 600 000	14	-	-	-	-	-	-	51,6 4 030 2/14,7	95,8 7 150 2/14,1	127 9 700 2/14,4	191 14 110 2/13,9	223 17 260 2/14,6	300 23 230 2/14,6	403 31 390 2/14,7	579 43 850 2/14,3	724 54 820 2/14,3	869 66 430 2/14,4	14	1800	125	
	12,5	2,35 175 2/12,3	4,59 360 2/13,1	4,59 375 2/13,6	7,87 645 2/13,7	9,11 745 2/13,7	20,7 1 520 2/12,3	38,4 2 990 2/13,1	54,9 4 360 2/13,3	80,8 6 550 2/13,6	108 8 830 2/13,6	168 12 980 2/13	228 17 330 2/12,8	334 26 070 2/13,1	425 33 790 2/13,3	513 40 940 2/13,4	704 56 170 2/13,4	859 67 420 2/13,1	12,5	1600	
	11,2	-	-	-	-	-	-	56,2 4 560 2/11,9	88 7 130 2/11,9	120 9 720 2/11,8	180 13 720 2/11,2	221 17 350 2/11,5	331 26 690 2/11,8	416 33 810 2/11,9	547 42 900 2/11,5	682 53 480 2/11,5	838 67 640 2/11,8	11,2	1400		
	10	2,48 195 2/10,2	4,57 375 2/10,7	4,95 425 2/11,2	9,23 725 2/10,3	10,9 855 2/10,3	20,9 1 630 2/10,2	40,8 3 350 2/10,7	55,8 4 350 2/10,2	92,5 7 280 2/10,3	122 9 930 2/10,7	177 13 870 2/10,2	230 17 530 2/9,95	337 27 660 2/10,7	428 34 030 2/10,4	611 48 030 2/10,3	763 60 040 2/10,7	834 68 080 2/10,7	10	1250	
	9	-	-	-	-	-	-	50,2 3 950 2/9,22	77,2 6 080 2/9,24	88,6 7 030 2/9,31	185 13 960 2/8,85	225 17 050 2/8,88	317 24 850 2/9,19	410 32 210 2/9,22	599 47 210 2/9,24	749 59 010 2/9,24	815 64 680 2/9,31	9	1120		
	8	2,46 190 2/8,01	4,9 385 2/8,26	6,24 475 2/7,99	9,97 765 2/8,03	12,3 945 2/8,03	21,3 1 630 2/8,01	42,2 3 330 2/8,26	-	79,6 6 110 2/8,03	-	180 13 800 2/8,01	-	317 25 000 2/8,26	-	570 43 720 2/8,03	710 54 460 2/8,03	-	8	1000	
	6,3	1,94 150 2/6,42	4,27 335 2/6,53	5,03 410 2/6,86	8,03 615 2/6,41	10 770 2/6,41	19,6 1 500 2/6,42	31,6 2 460 2/6,53	-	64,5 4 940 2/6,41	-	147 11 300 2/6,42	-	290 22 640 2/6,53	-	510 39 040 2/6,41	593 45 420 2/6,41	-	6,3	800	
	5	-	4 305 1/5	-	7,45 585 1/5,2	-	17,1 1 250 1/4,82	33,6 2 550 1/5	45,1 3 420 1/5	73 5 450 1/4,92	94,4 7 260 1/5,07	148 11 060 1/4,92	182 14 000 1/5,07	275 21 160 1/5,08	369 28 000 1/5	502 37 500 1/4,92	629 46 910 1/4,92	752 57 780 1/5,07	5	630	
	4,5	-	-	-	-	-	33,8 2 570 1/4,45	47,3 3 630 1/4,5	77,2 5 920 1/4,5	99 7 880 1/4,67	154 11 800 1/4,5	193 15 330 1/4,67	301 22 900 1/4,47	389 29 870 1/4,5	503 38 630 1/4,5	629 48 280 1/4,5	744 58 350 1/4,6	4,5	560		
	1 400 000	125	-	-	-	-	1 150 3/123	2 300 3/123	2 900 3/123	4 370 3/128	6 300 3/131	9 000 3/119	12 500 3/123	18 000 3/125	25 000 3/123	31 500 3/127	37 500 3/127	50 000 3/131			
100		-	-	-	-	1 220 3/103	2 430 3/101	3 650 3/100	5 450 3/107	7 750 3/108	10 900 3/100	15 500 3/98,5	21 800 3/98,5	30 130 3/100	38 700 3/105	46 200 3/105	52 210 3/103				
90		-	-	-	-	-	-	3 870 3/89,4	5 600 3/93,7	7 500 3/93,3	11 500 3/86,4	16 000 3/88,8	23 000 3/89	27 850 3/89,7	37 810 3/90,1	47 260 3/90,1	52 300 3/92,7				
80		-	250 3/75,2	305 3/78,2	515 3/82,7	605 3/82,7	1 120 3/75,5	2 240 3/75,3	3 750 3/81,4	5 600 3/85,7	8 000 3/86,1	11 500 3/84	16 000 3/82,7	23 000 3/82,7	30 160 3/84,3	40 000 3/82,5	48 700 3/82,5	52 270 3/81,1			
71		-	-	-	-	-	-	4 000 3/72,8	6 000 3/74,9	8 580 3/74,6	12 200 3/72,6	17 000 3/74,5	24 300 3/74,7	27 920 3/75,3	37 630 3/71	47 030 3/71	55 530 3/73				
63		-	305 3/60,1	375 3/62,6	610 3/66,3	720 3/66,3	1 360 3/61,5	2 720 3/60,2	4 000 3/62	6 000 3/63,5	8 500 3/63,8	12 200 3/62,6	17 000 3/61,7	24 300 3/61,5	29 340 3/62,7	42 290 3/67,1	52 860 3/67,1	55 440 3/66			
56		-	-	-	-	-	-	4 120 3/55,4	6 300 3/55,5	8 390 3/55,3	12 800 3/54,1	18 000 3/55,5	25 700 3/55,6	29 280 3/56	37 730 3/57,8	47 160 3/57,8	58 560 3/59,4				
50		-	325 3/49,4	410 3/51,5	690 3/49,8	825 3/49,8	1 450 3/51,2	2 830 3/49,5	4 250 3/50,4	6 300 3/50,8	8 840 3/51	13 040 3/52,6	18 000 3/51,8	26 170 3/51,7	29 460 3/52,7	42 190 3/52,9	52 740 3/52,9	58 470 3/52			
45	-	-	-	-	-	-	4 500 3/45,1	6 700 3/44,4	8 940 3/44,2	13 600 3/45,4	19 000 3/46,6	26 770 3/46,7	30 490 3/47,1	38 660 3/45,5	48 100 3/45,5	60 990 3/46,8					

For n_1 lower than 560 min⁻¹ see page 107.

7 - Selection tables (helical gear reducers)

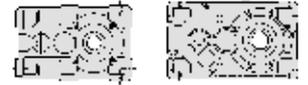

$n_{N2} \cdot L_h$ min ⁻¹ · h	i_N	P_{N2} kW																i_N	n_1	n_{N2}	
		M_{N2} N m																			
		50	63	64	80	81	100	125	140	160	180	200	225	250	280	320	321				360
1 400 000	40	-	335 3i/40,8	375 3i/42,5	615 3i/43,6	720 3i/43,6	1 500 3i/39,1	2 860 3i/40,8	4 060 3i/38,7	6 700 3i/38,5	8 330 3i/39,9	13 600 3i/41,5	17 590 3i/40,4	25 350 3i/42,4	30 880 3i/41,2	39 140 3i/40,7	48 710 3i/40,7	61 760 3i/42,3			
	35,5	-	-	-	-	-	-	-	4 080 3i/37,5	6 700 3i/36,5	7 940 3i/36,3	13 840 3i/34,4	16 190 3i/35,4	25 720 3i/36,9	31 320 3i/37,2	39 700 3i/37,4	49 400 3i/37,4	62 640 3i/38,4			
	31,5	-	325 3i/33,5	365 3i/34,9	730 3i/32,8	825 3i/32,8	1 400 3i/32,6	2 520 3i/33,5	3 660 3i/32,2	6 380 3i/31,6	7 590 3i/32,8	13 450 3i/31,5	16 110 3i/30,6	24 230 3i/33,5	31 770 3i/32,5	40 270 3i/33,5	50 110 3i/33,5	63 530 3i/34,7			
	28	-	-	-	-	-	1 200 2i/28,8	-	3 400 3i/29,1	5 720 3i/28,4	6 710 3i/28,6	12 050 3i/27,2	15 080 3i/27,3	23 330 3i/28,7	30 140 3i/28,8	40 850 3i/30	50 830 3i/30	61 880 3i/30,3			
	25	1,51 2i/24,4	3,54 2i/24,1	4 2i/25,1	5,94 2i/26	6,87 2i/26	16,2 2i/23,7	30,5 2i/24,1	42,7 3 510 2i/24,6	65,5 5 500 2i/25,4	92,4 7 990 2i/25,4	134 11 100 2i/24,2	188 16 000 2i/25	268 22 860 2i/25	366 30 710 2i/24,6	- 33 760 2i/25	- 47 110 2i/25	- 62 590 2i/25,7	25	2800	112
	22,4	-	-	-	-	-	-	-	48,7 4 030 2i/21,7	73 6 270 2i/22,5	99,4 8 860 2i/23,3	141 11 970 2i/22,2	197 17 330 2i/23	277 23 290 2i/22	377 31 900 2i/22,2	- 37 530 2i/22,8	- 48 480 2i/22,8	- 63 280 2i/23,4	22,4	2500	
	20	1,72 145 2i/20,1	4,36 360 2i/19,3	4,37 375 2i/20,1	7,04 625 2i/20,8	8,15 725 2i/20,8	18,6 1 530 2i/19,3	36,5 3 000 2i/19,3	52,2 4 370 2i/19,6	74,5 6 570 2i/20,7	99,9 8 850 2i/20,8	150 13 030 2i/20,3	213 18 190 2i/20	311 26 130 2i/19,7	396 33 870 2i/20,1	- 40 330 2i/20,6	- 56 340 2i/20,6	- 69 380 2i/20,3	20	2240	
	18	-	-	-	-	-	-	-	54,5 4 570 2i/17,6	82,8 7 150 2i/18,1	106 9 120 2i/18	165 13 850 2i/17,6	210 18 130 2i/18,1	315 26 730 2i/17,8	387 33 170 2i/17,9	501 42 530 2i/17,8	627 53 160 2i/17,8	779 67 980 2i/18,3	18	2000	
	16	2 175 2i/16,3	4,35 365 2i/15,8	4,84 425 2i/16,5	8,7 725 2i/15,7	10,3 855 2i/15,7	18,8 1 600 2i/16,1	38,1 3 200 2i/15,8	51,7 4 130 2i/15,1	87,7 7 290 2i/15,7	100 8 850 2i/16,6	169 14 460 2i/16,1	221 18 300 2i/15,6	326 27 980 2i/16,2	375 31 220 2i/15,7	570 48 140 2i/15,9	713 60 180 2i/15,9	813 68 990 2i/16	16	1800	
	14	-	-	-	-	-	-	-	46,1 4 040 2i/14,7	85,5 7 180 2i/14,1	113 9 740 2i/14,4	175 14 510 2i/13,9	199 17 330 2i/14,6	268 23 320 2i/14,6	371 32 520 2i/14,7	533 45 430 2i/14,3	666 56 790 2i/14,3	801 68 820 2i/14,4	14	1600	
	12,5	2,07 175 2i/12,3	4,03 360 2i/13,1	4,07 380 2i/13,6	6,99 655 2i/13,7	8,1 755 2i/13,7	18,2 1 530 2i/12,3	33,7 3 010 2i/13,1	48,2 4 380 2i/13,3	71 6 580 2i/13,6	95,2 8 860 2i/13,6	148 13 030 2i/13	207 18 030 2i/12,8	294 26 180 2i/13,1	374 33 940 2i/13,3	456 41 600 2i/13,4	619 56 400 2i/13,4	783 70 170 2i/13,1	12,5	1400	
	11,2	-	-	-	-	-	-	-	50,4 4 580 2i/11,9	78,9 7 160 2i/11,8	108 9 750 2i/11,8	162 13 860 2i/11,2	205 17 950 2i/11,5	297 26 780 2i/11,8	374 34 030 2i/11,9	491 43 180 2i/11,5	612 53 810 2i/11,5	773 69 900 2i/11,8	11,2	1250	
	10	2,23 195 2i/10,2	4,23 385 2i/10,7	4,45 425 2i/11,2	8,3 730 2i/10,3	9,76 855 2i/10,3	19,3 1 690 2i/10,2	36,7 3 360 2i/10,7	50,2 4 370 2i/10,2	83,2 7 300 2i/10,3	109 9 930 2i/10,7	164 14 340 2i/10,2	213 18 110 2i/9,95	306 28 040 2i/10,7	386 34 240 2i/10,4	549 48 200 2i/10,3	686 60 250 2i/10,3	752 68 510 2i/10,7	10	1120	
	9	-	-	-	-	-	-	-	44,9 3 950 2i/9,22	69,4 6 120 2i/9,24	79,6 7 080 2i/9,31	171 14 440 2i/8,85	208 17 640 2i/8,88	289 25 320 2i/9,19	368 32 410 2i/9,22	553 48 840 2i/9,24	692 61 050 2i/9,24	732 65 090 2i/9,31	9	1000	
	8	2,29 195 2i/8,01	4,41 385 2i/8,26	5,73 485 2i/7,99	9 765 2i/8,03	11,1 945 2i/8,03	19,8 1 680 2i/8,01	38,2 3 350 2i/8,26	-	72,1 6 140 2i/8,03	-	168 14 240 2i/8,01	-	287 25 140 2i/8,26	-	516 43 980 2i/8,03	643 54 770 2i/8,03	-	8	900	
6,3	1,73 150 2i/6,42	3,93 345 2i/6,53	4,47 410 2i/6,86	7,16 615 2i/6,41	8,95 770 2i/6,41	17,4 1 500 2i/6,42	28,2 2 480 2i/6,53	-	57,6 4 970 2i/6,41	-	132 11 370 2i/6,42	-	259 22 780 2i/6,53	-	457 39 420 2i/6,41	530 45 720 2i/6,41	-	6,3	710		
5	-	3,57 305 i/5	-	6,64 590 i/5,2	-	15,2 1 250 i/4,82	30 2 560 i/5	40,1 3 420 i/5	64,9 5 450 i/4,92	83,9 7 260 i/5,07	132 11 100 i/4,92	162 14 000 i/5,07	253 21 920 i/5,08	328 28 000 i/5	447 37 500 i/4,92	561 47 080 i/4,92	671 58 000 i/5,07	5	560		
1 250 000	125	-	-	-	-	1 180 3i/123	2 360 3i/123	3 000 3i/123	4 500 3i/128	6 300 3i/131	9 250 3i/119	12 800 3i/123	18 500 3i/125	25 700 3i/123	31 500 3i/127	38 700 3i/127	51 500 3i/131				

For n_1 lower than 560 min⁻¹ see page 107.

7 - Selection tables (helical gear reducers)



$n_{N2} \cdot L_h$ min ⁻¹ · h	i_N	P_{N2} kW M_{N2} N m ... / i																i_N	n_1 min ⁻¹	n_{N2} min ⁻¹	
		50	63	64	80	81	100	125	140	160	180	200	225	250	280	320	321				360
1 250 000	100	-	-	-	-	-	1 250 31/103	2 500 31/101	3 750 31/100	5 600 31/107	7 750 31/108	11 200 31/100	15 500 31/98,5	22 400 31/98,5	31 170 31/100	38 700 31/105	47 500 31/105	54 020 31/103			
	90	-	-	-	-	-	-	3 870 31/89,4	5 800 31/93,7	7 750 31/93,3	11 800 31/86,4	16 500 31/88,8	23 600 31/89	28 750 31/89,7	39 030 31/90,1	48 780 31/90,1	53 790 31/92,7				
	80	-	255 31/75,2	315 31/78,2	520 31/82,7	610 31/82,7	1 150 31/75,5	2 300 31/75,3	3 870 31/81,4	5 800 31/85,7	8 250 31/86,1	11 800 31/84	16 500 31/82,7	23 600 31/82,7	31 250 31/84,3	41 200 31/82,5	50 000 31/82,5	53 960 31/81,1			
	71	-	-	-	-	-	-	-	4 120 31/72,8	6 150 31/74,9	8 900 31/74,6	12 500 31/72,6	17 500 31/74,5	25 000 31/74,7	28 940 31/75,3	39 000 31/71	48 750 31/71	57 050 31/73			
	63	-	315 31/60,1	375 31/62,6	615 31/66,3	725 31/66,3	1 400 31/61,5	2 800 31/60,2	4 120 31/62	6 150 31/63,5	8 870 31/63,8	12 500 31/62,6	17 500 31/61,7	25 000 31/61,5	30 420 31/62,7	43 840 31/67,1	53 000 31/67,1	56 910 31/66			
	56	-	-	-	-	-	-	-	4 250 31/55,4	6 500 31/55,5	8 420 31/55,3	13 200 31/54,1	18 500 31/55,5	26 820 31/55,6	30 080 31/56	39 080 31/57,8	48 860 31/57,8	60 170 31/59,4			
	50	-	335 31/49,4	425 31/51,5	710 31/49,8	850 31/49,8	1 450 31/51,2	2 930 31/49,5	4 390 31/50,4	6 590 31/50,8	8 880 31/51	13 090 31/52,6	18 680 31/51,8	26 270 31/51,7	30 480 31/52,7	43 650 31/52,9	54 560 31/52,9	59 270 31/52			
	45	-	-	-	-	-	-	-	4 590 31/45,1	6 700 31/44,4	9 230 31/44,2	13 910 31/45,4	19 000 31/46,6	26 860 31/46,7	30 880 31/47,1	39 140 31/45,5	48 710 31/45,5	61 760 31/46,8			
	40	-	335 31/40,8	375 31/42,5	615 31/43,6	725 31/43,6	1 530 31/39,1	2 960 31/40,8	4 200 31/38,7	6 700 31/38,5	8 630 31/39,9	13 600 31/41,5	18 230 31/40,4	26 260 31/42,4	31 320 31/41,2	39 700 31/40,7	49 400 31/40,7	62 640 31/42,3			
	35,5	-	-	-	-	-	-	-	4 230 31/37,5	6 900 31/36,5	8 140 31/36,3	13 890 31/34,4	16 780 31/35,4	26 660 31/36,9	31 770 31/37,2	40 270 31/37,4	50 110 31/37,4	63 530 31/38,4			
	31,5	-	335 31/33,5	375 31/34,9	730 31/32,8	825 31/32,8	1 400 31/32,6	2 610 31/33,5	3 760 31/32,2	6 610 31/31,6	7 700 31/32,8	13 940 31/31,5	16 340 31/30,6	25 110 31/33,5	32 220 31/32,5	40 850 31/33,5	50 830 31/33,5	64 450 31/34,7			
	28	-	-	-	-	-	12,2 21/28,8	-	35,5 31/29,1	59,9 31/28,4	69,8 31/28,6	134 31/27,2	164 31/27,3	242 31/28,7	311 31/28,8	404 31/30 ▲	503 31/30 ▲	608 31/30,3 ▲	28	2800	100
	25	1,36 21/24,4	3,18 21/24,1	3,59 21/25,1	5,38 21/26	6,21 21/26	14,6 21/23,7	27,3 21/24,1	38,3 21/24,1	58,7 21/24,6	82,8 21/25,4	120 21/24,2	168 21/25	240 21/25	328 21/24,6	420 21/25	520 21/25	640 21/25,7	25	2500	
	22,4	-	-	-	-	-	-	-	43,8 21/21,7	65,6 21/22,5	89,4 21/23,3	127 21/22,2	178 21/23	249 21/22	349 21/22,2	-	-	-	22,4	2240	
	20	1,54 21/20,1	3,91 21/19,3	3,91 21/20,1	6,37 21/20,8	7,37 21/20,8	16,6 21/19,3	32,7 21/19,3	46,8 21/19,6	66,8 21/20,7	89,6 21/20,8	135 21/20,3	195 21/20	279 21/19,7	355 21/20,1	415 21/20,6	574 21/20,6	740 21/20,3	20	2000	
	18	-	-	-	-	-	-	-	49,2 21/17,6	74,7 21/18,1	95,8 21/18	149 21/17,6	195 21/18,1	284 21/17,8	353 21/17,9	453 21/17,8	566 21/17,8	724 21/18,3	18	1800	
16	1,79 21/16,3	3,97 21/15,8	4,31 21/16,5	7,77 21/15,7	9,18 21/15,7	17,2 21/16,1	35,1 21/15,8	46,2 21/15,1	78,3 21/15,7	89,6 21/16,6	151 21/16,1	203 21/15,6	291 21/16,2	338 21/15,7	509 21/15,9	636 21/15,9	748 21/16	16	1600		
14	-	-	-	-	-	-	-	40,5 21/14,7	75,1 21/14,1	99,6 21/14,4	154 21/13,9	174 21/14,6	235 21/14,6	336 21/14,7	486 21/14,3	607 21/14,3	729 21/14,4	14	1400		

For n_1 lower than 560 min⁻¹ see page 107.

▲ Possible forced lubrication with heat exchanger: consult us.

7 - Selection tables (helical gear reducers)

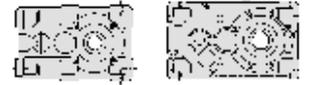

$n_{N2} \cdot L_h$ min ⁻¹ · h	i_N	P_{N2} kW M_{N2} N m ... / i																i_N	n_1 min ⁻¹	n_{N2} min ⁻¹									
		50	63	64	80	81	100	125	140	160	180	200	225	250	280	320	321				360								
1 250 000	12,5	1,85 175 2/12,3	3,61 360 2/13,1	3,64 380 2/13,6	6,27 655 2/13,7	7,25 760 2/13,7	16,3 1 530 2/12,3	30,2 3 020 2/13,1	43,2 4 400 2/13,3	63,6 6 600 2/13,6	85,3 8 900 2/13,6	132 13 080 2/13	191 18 660 2/12,8	263 26 280 2/13,1	335 34 060 2/13,3	410 41 880 2/13,4	554 56 610 2/13,4	723 72 600 2/13,1	12,5	1250	100								
	11,2	-	-	-	-	-	-	-	45,3 4 590 2/11,9	70,9 7 180 2/11,9	97 9 790 2/11,8	146 13 910 2/11,2	189 18 560 2/11,5	267 26 870 2/11,8	337 34 240 2/11,9	443 43 440 2/11,5	552 54 130 2/11,5	716 72 240 2/11,8				11,2	1120						
	10	2 195 2/10,2	3,78 385 2/10,7	3,99 425 2/11,2	7,44 730 2/10,3	8,75 860 2/10,3	16,9 1 650 2/10,2	32,9 3 370 2/10,7	44,8 4 370 2/10,2	74,5 7 330 2/10,3	97,3 9 930 2/10,7	149 14 530 2/10,2	197 18 740 2/9,95	275 28 140 2/10,7	347 34 460 2/10,4	492 48 370 2/10,3	615 60 470 2/10,3	692 70 550 2/10,7						10	1000				
	9	-	-	-	-	-	-	-	40,4 3 950 2/9,22	62,8 6 160 2/9,24	72,1 7 120 2/9,31	155 14 560 2/8,85	193 18 210 2/8,88	268 26 130 2/9,19	333 32 600 2/9,22	514 50 410 2/9,24	643 63 010 2/9,24	663 65 480 2/9,31								9	900		
	8	2,11 200 2/8,01	3,92 385 2/8,26	5,11 485 2/7,99	8,03 770 2/8,03	9,9 950 2/8,03	17,8 1 700 2/8,01	34 3 350 2/8,26	-	64,5 6 180 2/8,03	-	154 14 760 2/8,01	-	256 25 290 2/8,26	-	473 45 390 2/8,03	592 56 740 2/8,03	-										8	800
	6,3	1,54 150 2/6,42	3,48 345 2/6,53	3,96 410 2/6,86	6,37 620 2/6,41	7,97 775 2/6,41	15,9 1 550 2/6,42	25,2 2 490 2/6,53	-	51,4 5 000 2/6,41	-	118 11 440 2/6,42	-	231 22 920 2/6,53	-	409 39 800 2/6,41	473 46 020 2/6,41	-											
160	-	-	-	-	-	1000 3/151	2 000 3/153	-	-	-	-	-	-	-	-	-	-	160	16000										
125	-	-	-	-	-	1 220 3/123	2 430 3/123	3 150 3/123	4 620 3/128	6 500 3/131	9 500 3/119	13 200 3/123	19 000 3/125	26 500 3/123	32 500 3/127	40 000 3/127	53 000 3/131												
100	-	-	-	-	-	1 280 3/103	2 570 3/101	3 750 3/100	5 600 3/107	8 000 3/108	11 500 3/100	16 000 3/98,5	23 000 3/98,5	32 170 3/100	40 000 3/105	48 700 3/105	55 750 3/103												
90	-	-	-	-	-	-	-	4 000 3/89,4	6 000 3/93,7	8 000 3/93,3	12 200 3/86,4	17 000 3/88,8	24 300 3/89	29 780 3/89,7	40 430 3/90,1	50 540 3/90,1	55 530 3/92,7												
80	-	265 3/75,2	325 3/78,2	520 3/82,7	610 3/82,7	1 180 3/75,5	2 360 3/75,3	4 000 3/81,4	6 000 3/85,7	8 500 3/86,1	12 200 3/84	17 000 3/82,7	24 300 3/82,7	32 390 3/84,3	42 500 3/82,5	51 500 3/82,5	55 710 3/81,1												
71	-	-	-	-	-	-	-	4 250 3/72,8	6 300 3/74,9	9 220 3/74,6	12 800 3/72,6	18 000 3/74,5	25 700 3/74,7	30 000 3/75,3	40 420 3/71	50 530 3/71	58 560 3/73												
63	-	325 3/60,1	375 3/62,6	615 3/66,3	725 3/66,3	1 450 3/61,5	2 900 3/60,2	4 250 3/62	6 300 3/63,5	8 910 3/63,8	13 110 3/62,6	18 000 3/61,7	26 320 3/61,5	31 510 3/62,7	45 410 3/67,1	54 500 3/67,1	58 470 3/66												
56	-	-	-	-	-	-	-	4 370 3/55,4	6 700 3/55,5	8 450 3/55,3	13 600 3/54,1	19 000 3/55,5	26 920 3/55,6	30 490 3/56	40 440 3/57,8	50 550 3/57,8	60 990 3/59,4												
50	-	335 3/49,4	425 3/51,5	710 3/49,8	860 3/49,8	1 500 3/51,2	3 020 3/49,5	4 400 3/50,4	6 610 3/50,8	8 910 3/51	13 130 3/52,6	18 740 3/51,8	26 350 3/51,7	31 450 3/52,7	45 050 3/52,9	56 310 3/52,9	60 020 3/52												
45	-	-	-	-	-	-	-	4 600 3/45,1	6 700 3/44,4	9 560 3/44,2	13 960 3/45,4	19 780 3/46,6	26 960 3/46,7	31 320 3/47,1	40 170 3/45,5	50 210 3/45,5	62 640 3/46,8												
40	-	345 3/40,8	375 3/42,5	615 3/43,6	725 3/43,6	1 540 3/39,1	3 030 3/40,8	4 360 3/38,7	6 900 3/38,5	8 940 3/39,9	14 000 3/41,5	18 890 3/40,4	27 220 3/42,4	31 770 3/41,2	40 270 3/40,7	50 110 3/40,7	63 530 3/42,3												
35,5	-	-	-	-	-	-	-	4 380 3/37,5	6 900 3/36,5	8 440 3/36,3	13 950 3/34,4	17 390 3/35,4	26 960 3/36,9	32 220 3/37,2	40 850 3/37,4	50 830 3/37,4	64 450 3/38,4												

For n_1 lower than 560 min⁻¹ see page 107.

7 - Selection tables (helical gear reducers)



$n_{N2} \cdot L_h$ min ⁻¹ · h	i_N	P_{N2} kW M_{N2} N m ... / i																i_N	n_1 min ⁻¹	n_{N2} min ⁻¹	
		50	63	64	80	81	100	125	140	160	180	200	225	250	280	320	321				360
1 120 000	31,5	-	2,93 335 3i/33,5	3,15 375 3i/34,9	6,57 735 3i/32,8	7,61 850 3i/32,8	13,1 1 450 3i/32,6	23,7 2 710 3i/33,5	35,5 3 900 3i/32,2	63,5 6 850 3i/31,6	70,5 7 890 3i/32,8	134 14 450 3i/31,5	159 16 570 3i/30,6	227 26 020 3i/33,5	294 32 680 3i/32,5	363 41 430 3i/33,5▲	452 51 550 3i/33,5▲	552 65 360 3i/34,7▲	31,5	2800	90
	28	-	-	-	-	-	11 1 210 2i/28,8	-	32,8 3 640 3i/29,1	54,2 5 880 3i/28,4	63,2 6 900 3i/28,6	124 12 920 3i/27,2	149 15 500 3i/27,3	219 23 980 3i/28,7	281 30 980 3i/28,8	366 41 990 3i/30	455 52 250 3i/30	550 63 610 3i/30,3	28	2500	
	25	1,22 125 2i/24,4	2,86 295 2i/24,1	3,23 345 2i/25,1	4,88 540 2i/26	5,64 625 2i/26	13,1 1 320 2i/23,7	24,5 2 520 2i/24,1	34,4 3 540 2i/24,1	52,8 5 540 2i/24,6	74,4 8 050 2i/25,4	108 11 180 2i/24,2	151 16 110 2i/25	216 23 020 2i/25	295 30 930 2i/24,6	-	-	-	25	2240	
	22,4	-	-	-	-	-	-	-	39,2 4 060 2i/21,7	58,8 6 320 2i/22,5	80,1 8 920 2i/23,3	114 12 050 2i/22,2	159 17 450 2i/23	223 23 450 2i/22,2	319 33 720 2i/22,2	353 38 550 2i/22,8	448 48 820 2i/22,8	607 67 660 2i/23,4	22,4	2000	
	20	1,39 150 2i/20,1	3,53 360 2i/19,3	3,53 375 2i/20,1	5,81 640 2i/20,8	6,72 745 2i/20,8	15 1 540 2i/19,3	29,5 3 020 2i/19,3	42,2 4 400 2i/19,6	60,3 6 610 2i/20,7	80,9 8 910 2i/20,8	121 13 120 2i/20,3	176 18 720 2i/20	252 26 310 2i/19,7	320 34 110 2i/20,1	378 41 400 2i/20,6	518 56 730 2i/20,6	688 74 080 2i/20,3	20	1800	
	18	-	-	-	-	-	-	-	43,9 4 600 2i/17,6	66,7 7 200 2i/18,1	85,5 9 190 2i/18	133 13 950 2i/17,6	180 19 390 2i/18,1	253 26 920 2i/17,8	322 34 490 2i/17,9	408 43 260 2i/17,8	508 53 890 2i/17,8	666 72 690 2i/18,3	18	1600	
	16	1,57 175 2i/16,3	3,58 385 2i/15,8	3,79 425 2i/16,5	6,82 730 2i/15,7	8,07 860 2i/15,7	15,5 1 700 2i/16,1	31,2 3 370 2i/15,8	40,6 4 170 2i/15,1	68,8 7 350 2i/15,7	78,7 8 920 2i/16,6	133 14 590 2i/16,1	179 19 120 2i/15,6	256 28 210 2i/16,2	306 32 760 2i/15,7	447 48 520 2i/15,9	559 60 650 2i/15,9	679 74 160 2i/16	16	1400	
	14	-	-	-	-	-	-	-	36,3 4 070 2i/14,7	67,3 7 230 2i/14,1	89,2 9 820 2i/14,4	138 14 620 2i/13,9	156 17 460 2i/14,6	211 23 500 2i/14,6	301 33 790 2i/14,7	448 48 920 2i/14,3	561 61 160 2i/14,3	674 74 110 2i/14,4	14	1250	
	12,5	1,67 175 2i/12,3	3,25 360 2i/13,1	3,27 380 2i/13,6	5,63 660 2i/13,7	6,52 760 2i/13,7	14,7 1 540 2i/12,3	27,2 3 030 2i/13,1	38,8 4 410 2i/13,3	57,2 6 620 2i/13,6	76,7 8 930 2i/13,6	119 13 130 2i/13	172 18 740 2i/12,8	237 26 370 2i/13,1	301 34 180 2i/13,3	370 42 140 2i/13,4	499 56 800 2i/13,4	662 74 220 2i/13,1	12,5	1120	
	11,2	-	-	-	-	-	-	-	40,6 4 610 2i/11,9	63,5 7 210 2i/11,9	87 9 820 2i/11,8	131 13 960 2i/11,2	175 19 200 2i/11,5	239 26 970 2i/11,8	311 35 350 2i/11,9	398 43 720 2i/11,5	496 54 460 2i/11,5	662 74 740 2i/11,8	11,2	1000	
	10	1,81 195 2i/10,2	3,4 385 2i/10,7	3,6 430 2i/11,2	6,71 735 2i/10,3	7,9 865 2i/10,3	15,7 1 700 2i/10,2	29,7 3 380 2i/10,7	40,3 4 370 2i/10,2	67,3 7 350 2i/10,3	87,6 9 930 2i/10,7	134 14 580 2i/10,2	183 19 340 2i/9,95	248 28 230 2i/10,7	314 34 670 2i/10,4	444 48 530 2i/10,3	555 60 670 2i/10,3	643 72 820 2i/10,7	10	900	
	9	-	-	-	-	-	-	-	35,9 3 950 2i/9,22	56,2 6 200 2i/9,24	64,5 7 170 2i/9,31	138 14 620 2i/8,85	178 18 870 2i/8,88	247 27 070 2i/9,19	298 32 800 2i/9,22	473 52 220 2i/9,24	592 65 280 2i/9,24	593 65 910 2i/9,31	9	800	
	8	1,91 205 2i/8,01	3,48 385 2i/8,26	4,53 485 2i/7,99	7,16 775 2i/8,03	8,82 955 2i/8,03	15,8 1 700 2i/8,01	31 3 450 2i/8,26	-	57,6 6 230 2i/8,03	-	142 15 290 2i/8,01	-	229 25 450 2i/8,26	-	435 47 040 2i/8,03	544 58 810 2i/8,03	-	8	710	
	6,3	1,37 150 2i/6,42	3,1 345 2i/6,53	3,52 410 2i/6,86	5,69 620 2i/6,41	7,08 775 2i/6,41	14,2 1 550 2i/6,42	22,4 2 500 2i/6,53	-	45,7 5 000 2i/6,41	-	105 11 500 2i/6,42	-	206 23 000 2i/6,53	-	366 40 000 2i/6,41	422 46 200 2i/6,41	-	6,3	560	
1 000 000	160	-	-	-	-	1 030 3i/151	2 060 3i/153	-	-	-	-	-	-	-	-	-	-	-	-	-	-
	125	-	-	-	-	1 250 3i/123	2 500 3i/123	3 150 3i/123	4 750 3i/128	6 700 3i/131	9 750 3i/119	13 600 3i/123	19 500 3i/125	27 200 3i/123	33 500 3i/127	40 000 3i/127	54 500 3i/131	-	-	-	-
	100	-	-	-	-	1 320 3i/103	2 650 3i/101	3 870 3i/100	5 800 3i/107	8 250 3i/108	11 800 3i/100	16 500 3i/98,5	23 600 3i/98,5	33 330 3i/100	41 200 3i/105	50 000 3i/105	57 760 3i/103	-	-	-	-
	90	-	-	-	-	-	-	4 120 3i/89,4	6 150 3i/93,7	8 250 3i/93,3	12 500 3i/86,4	17 500 3i/88,8	25 000 3i/89	30 860 3i/89,7	41 900 3i/90,1	52 380 3i/90,1	57 050 3i/92,7	-	-	-	-

For n_1 lower than 560 min⁻¹ see page 107.

▲ Possible forced lubrication with heat exchanger: consult us.

7 - Selection tables (helical gear reducers)



$n_{N2} \cdot L_h$ min ⁻¹ · h	i_N	P_{N2} kW M_{N2} N m ... / i																i_N	n_1 min ⁻¹	n_{N2} min ⁻¹	
		50	63	64	80	81	100	125	140	160	180	200	225	250	280	320	321				360
1 000 000	80	-	270 31/75,2	335 31/78,2	520 31/82,7	615 31/82,7	1 220 31/75,5	2 430 31/75,3	4 120 31/81,4	6 150 31/85,7	8 960 31/86,1	12 500 31/84	17 500 31/82,7	25 000 31/82,7	33 570 31/84,3	43 700 31/82,5	53 000 31/82,5	57 750 31/81,1			
	71	-	-	-	-	-	-	-	4 370 31/72,8	6 500 31/74,9	9 250 31/74,6	13 200 31/72,6	18 500 31/74,5	27 070 31/74,7	31 080 31/75,3	41 880 31/71	52 340 31/71	60 170 31/73			
	63	-	335 31/60,1	380 31/62,6	620 31/66,3	730 31/63,3	1 450 31/61,5	2 900 31/60,2	4 420 31/62	6 500 31/63,5	8 940 31/63,8	13 160 31/62,6	18 780 31/61,7	26 410 31/61,5	32 600 31/62,7	45 610 31/67,1	56 000 31/67,1	59 270 31/66			
	56	-	-	-	-	-	-	-	4 370 31/55,4	6 700 31/55,5	8 480 31/55,3	13 600 31/54,1	19 000 31/55,5	27 010 31/55,6	30 880 31/56	41 730 31/57,8	52 170 31/57,8	61 760 31/59,4			
	50	-	335 31/49,4	430 31/51,5	735 31/49,8	865 31/49,8	1 500 31/51,2	3 000 31/49,5	4 420 31/50,4	6 630 31/50,8	8 940 31/51	13 180 31/52,6	18 810 31/51,8	26 450 31/51,7	32 590 31/52,7	45 590 31/52,9	56 990 31/52,9	60 870 31/52			
	45	-	-	-	-	-	-	-	4 620 31/45,1	6 900 31/44,4	9 840 31/44,2	14 010 31/45,4	19 850 31/46,6	27 060 31/46,7	31 770 31/47,1	41 630 31/45,5	52 040 31/45,5	63 530 31/46,8			
	40	-	345 31/40,8	380 31/42,5	620 31/43,6	730 31/43,6	1 550 31/39,1	3 040 31/40,8	4 520 31/38,7	6 900 31/38,5	9 270 31/39,9	14 000 31/41,5	19 580 31/40,4	28 210 31/42,4	32 220 31/41,2	40 850 31/40,7	50 830 31/40,7	64 450 31/42,3			
	35,5	-	-	-	-	-	-	-	35,5 4 540 31/37,5	58,1 7 230 31/36,5	70,5 8 740 31/36,3	119 14 000 31/34,4	149 18 020 31/35,4	215 27 060 31/36,9	258 32 680 31/37,2	325 41 430 31/37,4▲	405 51 610 31/37,4▲	498 65 360 31/38,4▲	35,5	2800	80
	31,5	-	2,7 345 31/33,5	2,9 385 31/34,9	5,89 735 31/32,8	6,93 865 31/32,8	11,7 1 450 31/32,6	21,9 2 800 31/33,5	32,8 4 030 31/32,2	58,6 7 080 31/31,6	65,1 8 160 31/32,8	122 14 630 31/31,5	144 16 800 31/30,6	210 26 920 31/33,5	266 33 130 31/32,5	329 41 990 31/33,5	409 52 250 31/33,5	500 66 250 31/34,7	31,5	2500	
	28	-	-	-	-	-	9,86 1 210 21/28,8	-	30,3 3 760 31/29,1	49,2 5 960 31/28,4	57,4 6 990 31/28,6	115 13 350 31/27,2	135 15 710 31/27,3	198 24 300 31/28,7	255 31 390 31/28,8	332 42 540 31/30	413 52 940 31/30	500 64 450 31/30,3	28	2240	
	25	1,09 125 21/24,4	2,56 295 21/24,1	2,89 345 21/25,1	4,42 550 21/26	5,11 635 21/26	11,7 1 330 21/23,7	22 2 530 21/24,1	30,8 3 550 21/24,1	47,3 5 560 21/24,6	66,7 8 070 21/25,4	96,9 11 220 21/24,2	136 16 170 21/25	194 23 100 21/25	264 31 040 21/24,6	294 35 140 21/25	399 47 610 21/25	552 67 850 21/25,7	25	2000	
	22,4	-	-	-	-	-	-	-	35,4 4 080 21/21,7	53,1 6 340 21/22,5	72,3 8 950 21/22,3	103 12 090 21/22,2	144 17 510 21/23	202 23 530 21/22,2	288 33 830 21/22,8	322 39 030 21/22,8	404 48 980 21/22,8	564 69 840 21/23,4	22,4	1800	
	20	1,24 150 21/20,1	3,15 360 21/19,3	3,15 380 21/20,1	5,23 650 21/20,8	6,06 755 21/20,8	13,4 1 540 21/19,3	26,3 3 030 21/19,3	37,7 4 420 21/19,6	53,8 6 640 21/20,7	72,1 8 940 21/20,8	108 13 170 21/20,3	157 18 790 21/20	225 26 410 21/19,7	286 34 230 21/20,1	341 41 990 21/20,6	462 56 940 21/20,6	614 74 400 21/20,3	20	1600	
	18	-	-	-	-	-	-	-	38,6 4 620 21/17,6	58,6 7 230 21/18,1	75,1 9 220 21/18	117 14 010 21/17,6	161 19 840 21/18,1	223 27 030 21/17,8	293 35 900 21/17,9	363 43 960 21/17,8	452 54 750 21/17,8	607 75 660 21/18,3	18	1400	
	16	1,41 175 21/16,3	3,2 385 21/15,8	3,4 430 21/16,5	6,11 730 21/15,7	7,23 865 21/15,7	13,8 1 700 21/16,1	28 3 390 21/15,8	36,3 4 180 21/15,1	61,6 7 370 21/15,7	70,5 8 950 21/16,6	119 14 640 21/16,1	161 19 190 21/15,6	229 28 310 21/16,2	283 33 890 21/15,7	401 48 700 21/15,9	501 60 870 21/15,9	609 74 420 21/16	16	1250	
	14	-	-	-	-	-	-	-	32,6 4 090 21/14,7	60,5 7 260 21/14,1	80,2 9 850 21/14,4	124 14 670 21/13,9	141 17 520 21/14,6	190 23 580 21/14,6	270 33 900 21/14,7	415 50 560 21/14,3	519 63 200 21/14,3	624 76 590 21/14,4	14	1120	
12,5	1,49 175 21/12,3	2,91 365 21/13,1	2,93 380 21/13,6	5,05 660 21/13,7	5,84 765 21/13,7	13,2 1 540 21/12,3	24,3 3 040 21/13,1	34,8 4 430 21/13,3	51,3 6 650 21/13,6	68,7 8 960 21/13,6	107 13 170 21/13	154 18 800 21/12,8	212 26 460 21/13,1	270 34 300 21/13,3	332 42 420 21/13,4	447 57 000 21/13,4	593 74 480 21/13,1	12,5	1000		
11,2	-	-	-	-	-	-	-	36,6 4 630 21/11,9	57,4 7 230 21/11,9	78,5 9 860 21/11,8	118 14 000 21/11,2	163 19 810 21/11,5	216 27 060 21/11,8	289 36 480 21/11,9	360 43 980 21/11,5	449 54 770 21/11,5	615 77 140 21/11,8	11,2	900		

For n_1 lower than 560 min⁻¹ see page 107.

▲ Possible forced lubrication with heat exchanger: consult us.

7 - Selection tables (helical gear reducers)



$n_{N2} \cdot L_h$ min ⁻¹ · h	i_N	P_{N2} kW																i_N	n_1	n_{N2} min ⁻¹	
		M_{N2} N m																			
		... / i																			
		50	63	64	80	81	100	125	140	160	180	200	225	250	280	320	321	360			
1 000 000	10	1,61 195 21/10,2	3,02 385 21/10,7	3,21 430 21/11,2	5,99 735 21/10,3	7,05 865 21/10,3	13,9 1 700 21/10,2	26,5 3 390 21/10,7	35,9 4 370 21/10,2	60,1 7 380 21/10,3	77,9 9 930 21/10,7	120 14 640 21/10,2	169 20 040 21/9,95	221 28 340 21/10,7	281 34 900 21/10,4	396 48 710 21/10,3	495 60 890 21/10,3	592 75 440 21/10,7	10	800	80
	9	-	-	-	-	-	-	-	31,8 3 950 21/9,22	50,2 6 240 21/9,24	57,6 7 220 21/9,31	123 14 670 21/8,85	159 18 930 21/8,88	227 28 050 21/9,19	266 33 010 21/9,22	423 52 600 21/9,24	529 65 750 21/9,24	544 68 160 21/9,31	9	710	
	8	1,7 205 21/8,01	3,09 385 21/8,26	4,02 485 21/7,99	6,37 775 21/8,03	7,86 955 21/8,03	14 1 700 21/8,01	27,5 3 450 21/8,26	-	51,5 6 270 21/8,03	-	128 15 500 21/8,01	-	209 26 150 21/8,26	-	401 48 760 21/8,03	501 60 950 21/8,03	-	8	630	
900 000	160	-	-	-	-	-	1 060 31/151	2 120 31/153	-	-	-	-	-	-	-	-	-	-			
	125	-	-	-	-	-	1 280 31/123	2 570 31/123	3 250 31/123	4 870 31/128	6 900 31/131	10 000 31/119	14 000 31/123	20 000 31/125	28 000 31/123	34 500 31/127	41 200 31/127	56 000 31/131			
	100	-	-	-	-	-	1 360 31/103	2 720 31/101	4 000 31/100	6 000 31/107	8 500 31/108	12 200 31/100	17 000 31/98,5	24 300 31/98,5	34 360 31/100	42 500 31/105	51 500 31/105	59 860 31/103			
	90	-	-	-	-	-	-	-	4 250 31/89,4	6 300 31/93,7	8 530 31/93,3	12 800 31/86,4	18 000 31/88,8	25 700 31/89	31 990 31/89,7	43 170 31/90,1	53 960 31/90,1	58 560 31/92,7			
	80	-	280 31/75,2	345 31/78,2	525 31/82,7	615 31/82,7	1 250 31/75,5	2 540 31/75,3	4 250 31/81,4	6 300 31/85,7	8 990 31/86,1	13 230 31/84	18 000 31/82,7	25 700 31/82,7	34 430 31/84,3	45 740 31/82,5	54 500 31/82,5	59 820 31/81,1			
	71	-	-	-	-	-	-	-	4 500 31/72,8	6 700 31/74,9	9 500 31/74,6	13 600 31/72,6	19 000 31/74,5	27 170 31/74,7	32 150 31/75,3	43 160 31/71	53 950 31/71	60 990 31/73			
	63	-	335 31/60,1	380 31/62,6	620 31/66,3	730 31/66,3	1 500 31/61,5	3 040 31/60,2	4 430 31/62	6 660 31/63,5	8 970 31/63,8	13 200 31/62,6	18 850 31/61,7	26 500 31/61,5	33 650 31/62,7	45 760 31/67,1	57 200 31/67,1	60 020 31/66			
	56	-	-	-	-	-	-	-	4 580 31/55,4	6 700 31/55,5	8 510 31/55,3	14 040 31/54,1	19 500 31/55,5	27 110 31/55,6	31 320 31/56	43 180 31/57,8	53 980 31/57,8	62 640 31/59,4			
	50	-	345 31/49,4	430 31/51,5	740 31/49,8	870 31/49,8	1 550 31/51,2	3 070 31/49,5	4 440 31/50,4	6 660 31/50,8	8 970 31/51	13 230 31/52,6	18 880 31/51,8	26 550 31/51,7	33 770 31/52,7	45 760 31/52,9	57 200 31/52,9	61 750 31/52			
	45	-	-	-	-	-	-	-	4 640 31/45,1	6 900 31/44,4	9 880 31/44,2	14 070 31/45,4	19 930 31/46,6	27 160 31/46,7	32 220 31/47,1	43 150 31/45,5	53 940 31/45,5	64 450 31/46,8			
	40	-	2,55 355 31/40,8	2,62 380 31/42,5	4,19 620 31/43,6	4,93 730 31/43,6	11,6 1 550 31/39,1	21,9 3 050 31/40,8	34,7 4 580 31/38,7	54,1 7 100 31/38,5	68,7 9 350 31/39,9	104 14 710 31/41,5	146 20 100 31/40,4	197 28 450 31/42,4	233 32 680 31/41,2	298 41 430 31/40,7▲	371 51 550 31/40,7▲	454 65 360 31/42,3▲	40	2800	71
	35,5	-	-	-	-	-	-	-	32,4 4 640 31/37,5	52 7 250 31/36,5	65,1 9 040 31/36,3	107 14 050 31/34,4	138 18 640 31/35,4	193 27 160 31/36,9	233 33 130 31/37,2	299 42 710 31/37,4	374 53 390 31/37,4	451 66 250 31/38,4	35,5	2500	
	31,5	-	2,42 345 31/33,5	2,6 385 31/34,9	5,29 740 31/32,8	6,23 870 31/32,8	10,8 1 500 31/32,6	20,2 2 900 31/33,5	30,3 4 170 31/32,2	54,3 7 320 31/31,6	60,3 8 440 31/32,8	109 14 680 31/31,5	130 17 020 31/30,6	195 27 820 31/33,5	242 33 560 31/32,5	298 42 540 31/33,5	371 52 940 31/33,5	454 67 130 31/34,7	31,5	2240	
	28	-	-	-	-	-	8,84 1 220 21/28,8	-	28 3 890 31/29,1	44,5 6 040 31/28,4	51,9 7 090 31/28,6	106 13 810 31/27,2	122 15 920 31/27,3	180 24 640 31/28,7	231 31 820 31/28,8	301 43 120 31/30	374 53 670 31/30	452 65 330 31/30,3	28	2000	
	25	-	0,99 130 21/24,4	2,31 295 21/24,1	2,61 345 21/25,1	4,03 555 21/26	4,65 640 21/26	10,6 1 330 21/23,7	19,9 2 540 21/24,1	27,9 3 560 21/24,1	42,7 5 580 21/24,6	60,2 8 100 21/25,4	87,5 11 250 21/24,2	122 16 220 21/25	175 23 180 21/25	238 31 140 21/24,6	273 36 200 21/25	360 47 770 21/25	498 68 080 21/25,7	25	1800

For n_1 lower than 560 min⁻¹ see page 107.

▲ Possible forced lubrication with heat exchanger: consult us.

7 - Selection tables (helical gear reducers)



$n_{N2} \cdot L_h$ min ⁻¹ · h	i_N	P_{N2} kW M_{N2} N m ... /i																i_N	n_1 min ⁻¹	n_{N2} min ⁻¹	
		50	63	64	80	81	100	125	140	160	180	200	225	250	280	320	321				360
900 000	22,4	-	-	-	-	-	-	-	31,6 4 090 21/21,7	47,4 6 360 21/22,5	64,5 8 980 21/23,3	91,8 12 140 21/22,2	128 17 570 21/23	180 23 620 21/22	257 33 960 21/22,2	290 39 590 21/22,8	361 49 160 21/22,8	519 72 350 21/23,4	22,4	1600	71
	20	1,09 150 21/20,1	2,77 365 21/19,3	2,79 380 21/20,1	4,65 660 21/20,8	5,39 765 21/20,8	11,8 1 550 21/19,3	23,1 3 040 21/19,3	33,1 4 430 21/19,6	47,3 6 660 21/20,7	63,4 8 980 21/20,8	95,2 13 220 21/20,3	138 18 870 21/20	197 26 520 21/19,7	251 34 380 21/20,1	303 42 660 21/20,6	406 57 180 21/20,6	539 74 710 21/20,3	20	1400	
	18	-	-	-	-	-	-	-	34,6 4 630 21/17,6	52,5 7 250 21/18,1	67,3 9 260 21/18	105 14 060 21/17,6	144 19 910 21/18,1	200 27 130 21/17,8	271 37 140 21/17,9	326 44 240 21/17,8	406 55 080 21/17,8	561 78 280 21/18,3	18	1250	
	16	1,26 175 21/16,3	2,87 385 21/15,8	3,05 430 21/16,5	5,5 735 21/15,7	6,5 870 21/15,7	12,4 1 700 21/16,1	25,2 3 400 21/15,8	32,7 4 200 21/15,1	55,4 7 400 21/15,7	63,4 8 980 21/16,6	107 14 690 21/16,1	144 19 250 21/15,6	206 28 410 21/16,2	262 35 030 21/15,7	360 48 870 21/15,9	450 61 080 21/15,9	547 74 680 21/16	16	1120	
	14	-	-	-	-	-	-	-	29,2 4 100 21/14,7	54,2 7 280 21/14,1	71,9 9 880 21/14,4	111 14 720 21/13,9	126 17 580 21/14,6	170 23 660 21/14,6	242 34 020 21/14,7	384 52 310 21/14,3	480 65 390 21/14,3	576 79 240 21/14,4	14	1000	
	12,5	1,35 175 21/12,3	2,63 365 21/13,1	2,65 380 21/13,6	4,56 660 21/13,7	5,27 765 21/13,7	11,9 1 550 21/12,3	22 3 050 21/13,1	31,4 4 440 21/13,3	46,3 6 670 21/13,6	62,1 8 990 21/13,6	96,2 13 220 21/13	139 18 870 21/12,8	191 26 550 21/13,1	244 34 410 21/13,3	301 42 680 21/13,4	403 57 190 21/13,4	536 74 730 21/13,1	12,5	900	
	11,2	-	-	-	-	-	-	-	32,7 4 640 21/11,9	51,2 7 260 21/11,9	70,1 9 890 21/11,8	105 14 050 21/11,2	145 19 910 21/11,5	193 27 160 21/11,8	266 37 800 21/11,9	322 44 260 21/11,5	401 55 120 21/11,5	566 79 910 21/11,8	11,2	800	
	10	1,44 200 21/10,2	2,68 385 21/10,7	2,86 430 21/11,2	5,34 740 21/10,3	6,28 870 21/10,3	12,3 1 700 21/10,2	23,6 3 410 21/10,7	31,8 4 370 21/10,2	53,5 7 410 21/10,3	69,1 9 930 21/10,7	107 14 690 21/10,2	155 20 770 21/9,95	197 28 450 21/10,7	252 35 330 21/10,4	353 48 900 21/10,3	441 61 120 21/10,3	544 78 190 21/10,7	10	710	
	9	-	-	-	-	-	-	-	28,3 3 950 21/9,22	44,8 6 280 21/9,24	51,5 7 270 21/9,31	110 14 730 21/8,85	141 18 930 21/8,88	208 29 000 21/9,19	238 33 220 21/9,22	377 52 800 21/9,24	471 66 000 21/9,24	501 70 650 21/9,31	9	630	
	8	1,51 205 21/8,01	2,75 385 21/8,26	3,58 485 21/7,99	5,66 775 21/8,03	7,01 960 21/8,03	12,4 1 700 21/8,01	24,5 3 450 21/8,26	-	46 6 300 21/8,03	-	114 15 500 21/8,01	-	192 27 090 21/8,26	-	369 50 520 21/8,03	461 63 150 21/8,03	-	8	560	
800 000	160	-	-	-	-	-	1 090 31/151	2 180 31/153	-	-	-	-	-	-	-	-	-	-	-	-	-
	125	-	-	-	-	-	1 320 31/123	2 650 31/123	3 350 31/123	5 000 31/128	7 100 31/131	10 300 31/119	14 500 31/123	20 600 31/125	29 000 31/123	35 500 31/127	42 500 31/127	58 000 31/131	-	-	-
	100	-	-	-	-	-	1 400 31/103	2 800 31/101	4 120 31/100	6 150 31/107	9 020 31/108	12 500 31/100	17 500 31/98,5	25 000 31/98,5	34 490 31/100	43 700 31/105	53 000 31/105	62 050 31/103	-	-	-
	90	-	-	-	-	-	-	-	4 370 31/89,4	6 500 31/93,7	8 560 31/93,3	13 200 31/86,4	18 500 31/88,8	27 220 31/89	33 140 31/89,7	43 330 31/90,1	54 160 31/90,1	60 170 31/92,7	-	-	-
	80	-	290 31/75,2	350 31/78,2	525 31/82,7	620 31/82,7	1 280 31/75,5	2 550 31/75,3	4 370 31/81,4	6 500 31/85,7	9 020 31/86,1	13 280 31/84	18 500 31/82,7	26 660 31/82,7	34 550 31/84,3	45 910 31/82,5	56 000 31/82,5	61 890 31/81,1	-	-	-
	71	-	-	-	-	-	-	-	4 500 31/72,8	6 700 31/74,9	9 500 31/74,6	13 600 31/72,6	19 000 31/74,5	27 260 31/74,7	33 180 31/75,3	43 300 31/71	54 130 31/71	61 760 31/73	-	-	-
	63	-	335 31/60,1	380 31/62,6	625 31/66,3	735 31/66,3	1 500 31/61,5	3 050 31/60,2	4 450 31/62	6 680 31/63,5	9 000 31/63,8	13 250 31/62,6	18 920 31/61,7	26 600 31/61,5	34 480 31/62,7	45 930 31/67,1	57 410 31/67,1	61 770 31/66	-	-	-
	56	-	-	-	-	-	-	-	4 590 31/55,4	6 900 31/55,5	8 540 31/55,3	14 090 31/54,1	19 960 31/55,5	27 210 31/55,6	32 280 31/56	43 350 31/57,8	54 180 31/57,8	63 530 31/59,4	-	-	-

For n_1 lower than 560 min⁻¹ see page 107.

7 - Selection tables (helical gear reducers)



$n_{N2} \cdot L_h$ min ⁻¹ · h	i_N	P_{N2} kW M_{N2} N m ... / i																i_N	n_1 min ⁻¹	n_{N2} min ⁻¹	
		50	63	64	80	81	100	125	140	160	180	200	225	250	280	320	321				360
800 000	50	-	345 3/49,4	430 3/51,5	740 3/49,8	870 3/49,8	1 550 3/51,2	3 070 3/49,5	4 450 3/50,4	6 680 3/50,8	9 010 3/51	13 280 3/52,6	18 950 3/51,8	26 650 3/51,7	34 540 3/52,7	45 930 3/52,9	57 420 3/52,9	62 630 3/52			
	45	-	-	-	-	-	-	-	30,3 4 650 3/45,1	46,9 7 100 3/44,4	65,7 9 910 3/44,2	91,1 14 120 3/45,4	126 20 000 3/46,6	171 27 270 3/46,7	204 32 680 3/47,1	279 43 340 3/45,5▲	349 54 180 3/45,5▲	409 65 360 3/46,8▲	45	2800	63
	40	-	2,35 365 3/40,8	2,35 380 3/42,5	3,76 625 3/43,6	4,41 735 3/43,6	10,4 1 560 3/39,1	19,6 3 060 3/40,8	31,1 4 600 3/38,7	48,3 7 100 3/38,5	61,5 9 380 3/39,9	93 14 760 3/41,5	131 20 170 3/40,4	176 28 550 3/42,4	211 33 130 3/41,2	270 41 990 3/40,7	336 52 250 3/40,7	410 66 250 3/42,3	40	2500	
	35,5	-	-	-	-	-	-	-	29,1 4 660 3/37,5	46,8 7 280 3/36,5	60,3 9 340 3/36,3	96 14 100 3/34,4	128 19 260 3/35,4	173 27 250 3/36,9	212 33 560 3/37,2	272 43 380 3/37,4	340 54 230 3/37,4	410 67 130 3/38,4	35,5	2240	
	31,5	-	2,22 355 3/33,5	2,32 385 3/34,9	4,74 740 3/32,8	5,58 875 3/32,8	9,65 1 500 3/32,6	18,7 3 000 3/33,5	28 4 310 3/32,2	49,2 7 430 3/31,6	55,7 8 730 3/32,8	98 14 730 3/31,5	118 17 270 3/30,6	178 28 540 3/33,5	219 34 020 3/32,5	270 43 120 3/33,5	336 53 670 3/33,5	411 68 040 3/34,7	31,5	2000	
	28	-	-	-	-	-	7,98 1 220 2/28,8	-	26 4 020 3/29,1	40,6 6 110 3/28,4	47,3 7 180 3/28,6	98,7 14 260 3/27,2	111 16 120 3/27,3	167 25 430 3/28,7	211 32 220 3/28,8	274 43 670 3/30	341 54 340 3/30	412 66 160 3/30,3	28	1800	
	25	0,88 130 2/24,4	2,06 295 2/24,1	2,33 350 2/25,1	3,63 565 2/26	4,19 650 2/26	9,45 1 340 2/23,7	17,7 2 550 2/24,1	24,9 3 570 2/24,1	38,1 5 600 2/24,6	53,7 8 130 2/25,4	78,1 11 300 2/24,2	109 16 280 2/25	156 23 260 2/25	213 31 260 2/24,6	251 37 500 2/25	321 47 940 2/25	445 68 330 2/25,7	25	1600	
	22,4	-	-	-	-	-	-	-	27,8 4 110 2/21,7	41,6 6 390 2/22,5	56,7 9 020 2/23,3	80,7 12 190 2/22,2	113 17 650 2/23	158 23 720 2/22	226 34 100 2/22,2	258 40 220 2/22,8	317 49 370 2/22,8	467 74 330 2/23,4	22,4	1400	
	20	0,98 150 2/20,1	2,48 365 2/19,3	2,5 385 2/20,1	4,17 665 2/20,8	4,82 770 2/20,8	10,5 1 560 2/19,3	20,7 3 050 2/19,3	29,7 4 450 2/19,6	42,4 6 690 2/20,7	56,8 9 010 2/20,8	85,3 13 270 2/20,3	124 18 940 2/20	177 26 620 2/19,7	225 34 500 2/20,1	272 42 940 2/20,6	364 57 390 2/20,6	483 74 980 2/20,3	20	1250	
	18	-	-	-	-	-	-	-	31,1 4 650 2/17,6	47,2 7 280 2/18,1	60,5 9 290 2/18	94,1 14 100 2/17,6	130 19 980 2/18,1	179 27 220 2/17,8	251 38 380 2/17,9	294 44 500 2/17,8	366 55 400 2/17,8	519 80 900 2/18,3	18	1120	
	16	1,13 175 2/16,3	2,56 385 2/15,8	2,74 430 2/16,5	4,93 735 2/15,7	5,83 870 2/15,7	11,1 1 700 2/16,1	22,6 3 410 2/15,8	29,3 4 210 2/15,1	49,6 7 430 2/15,7	56,8 9 010 2/16,6	96 14 740 2/16,1	129 19 320 2/15,6	185 28 510 2/16,2	242 36 240 2/15,7	323 49 040 2/15,9	404 61 300 2/15,9	490 74 950 2/16	16	1000	
	14	-	-	-	-	-	-	-	26,4 4 120 2/14,7	49 7 310 2/14,1	64,9 9 920 2/14,4	100 14 770 2/13,9	114 17 640 2/14,6	153 23 740 2/14,6	219 34 140 2/14,7	349 52 930 2/14,3	437 66 160 2/14,3	535 81 780 2/14,4	14	900	
	12,5	1,2 175 2/12,3	2,35 365 2/13,1	2,36 385 2/13,6	4,06 665 2/13,7	4,7 770 2/13,7	10,6 1 560 2/12,3	19,6 3 060 2/13,1	28 4 460 2/13,3	41,3 6 690 2/13,6	55,4 9 020 2/13,6	85,8 13 270 2/13	124 18 940 2/12,8	171 26 650 2/13,1	217 34 540 2/13,3	269 42 960 2/13,4	360 57 410 2/13,4	478 75 000 2/13,1	12,5	800	
	11,2	-	-	-	-	-	-	-	29,1 4 660 2/11,9	45,6 7 290 2/11,9	62,4 9 930 2/11,8	93,7 14 110 2/11,2	129 19 980 2/11,5	171 27 200 2/11,8	243 38 950 2/11,9	288 44 550 2/11,5	359 55 470 2/11,5	521 82 830 2/11,8	11,2	710	
	10	1,28 200 2/10,2	2,38 385 2/10,7	2,55 435 2/11,2	4,75 740 2/10,3	5,59 875 2/10,3	11 1 700 2/10,2	21 3 420 2/10,7	28,2 4 370 2/10,2	47,7 7 440 2/10,3	61,3 9 930 2/10,7	95,1 14 750 2/10,2	141 21 200 2/9,95	175 28 550 2/10,7	232 36 620 2/10,4	314 49 080 2/10,3	393 61 350 2/10,3	501 81 040 2/10,7	10	630	
	9	-	-	-	-	-	-	-	25,1 3 950 2/9,22	40 6 300 2/9,24	46 7 300 2/9,31	98 14 780 2/8,85	125 18 930 2/8,88	185 29 000 2/9,19	214 33 600 2/9,22	336 53 000 2/9,24	420 66 240 2/9,24	461 73 190 2/9,31	9	560	
710 000	160	-	-	-	-	1 120 3/151	2 240 3/153	-	-	-	-	-	-	-	-	-	-	-			
	125	-	-	-	-	1 360 3/123	2 720 3/123	3 450 3/123	5 150 3/128	7 300 3/131	10 600 3/119	14 500 3/123	21 200 3/125	29 000 3/123	36 500 3/127	43 700 3/127	58 000 3/131				

For n_1 lower than 560 min⁻¹ see page 107.

▲ Possible forced lubrication with heat exchanger: consult us.

7 - Selection tables (helical gear reducers)

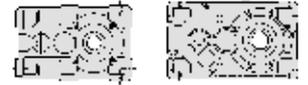

$n_{N2} \cdot L_h$ min ⁻¹ · h	i_N	P_{N2} kW																i_N	n_1	n_{N2}	
		M_{N2} N m																			
		... / i																			
		50	63	64	80	81	100	125	140	160	180	200	225	250	280	320	321	360			
710 000	100	-	-	-	-	-	1 450 31/103	2 900 31/101	4 250 31/100	6 300 31/107	9 050 31/108	12 800 31/100	18 000 31/98,5	25 700 31/98,5	34 620 31/100	46 090 31/105	54 500 31/105	64 280 31/103			
	90	-	-	-	-	-	-	-	4 500 31/89,4	6 700 31/93,7	8 590 31/93,3	13 600 31/86,4	19 000 31/88,8	27 320 31/89	34 290 31/89,7	43 490 31/90,1	54 360 31/90,1	60 990 31/92,7			
	80	-	290 31/75,2	350 31/78,2	525 31/82,7	620 31/82,7	1 280 31/75,5	2 560 31/75,3	4 470 31/81,4	6 500 31/85,7	9 050 31/86,1	13 330 31/84	19 020 31/82,7	26 750 31/82,7	34 670 31/84,3	46 060 31/82,5	57 580 31/82,5	63 880 31/81,1			
	71	-	-	-	-	-	-	-	4 670 31/72,8	6 700 31/74,9	9 750 31/74,6	13 600 31/72,6	19 500 31/74,5	27 360 31/74,7	34 380 31/75,3	43 470 31/71	54 330 31/71	62 640 31/73			
	63	-	345 31/60,1	380 31/62,6	625 31/66,3	735 31/66,3	1 560 31/61,5	3 060 31/60,2	4 470 31/62	6 700 31/63,5	9 040 31/63,8	13 300 31/62,6	18 990 31/61,7	26 700 31/61,5	34 600 31/62,7	46 100 31/67,1	57 630 31/67,1	64 020 31/66			
	56	-	-	-	-	-	-	-	4 610 31/55,4	6 900 31/55,5	8 570 31/55,3	14 140 31/54,1	20 040 31/55,5	27 310 31/55,6	33 460 31/56	43 510 31/57,8	54 390 31/57,8	64 450 31/59,4			
	50	-	2,11 355 31/49,4	2,46 435 31/51,5	4,38 745 31/49,8	5,15 875 31/49,8	8,88 1 550 31/51,2	18,7 3 150 31/49,5	26 4 470 31/50,4	38,7 6 710 31/50,8	51,9 9 040 31/51	74,3 13 330 31/52,6	108 19 020 31/51,8	152 26 750 31/51,7	193 34 670 31/52,7	256 46 100 31/52,9▲	320 57 630 31/52,9▲	360 63 860 31/52▲	50	2800	56
	45	-	-	-	-	-	-	-	27,1 4 670 31/45,1	43 7 300 31/44,4	58,9 9 950 31/44,2	81,7 14 170 31/45,4	113 20 070 31/46,6	153 27 360 31/46,7	187 33 520 31/47,1	250 43 500 31/45,5	313 54 370 31/45,5	371 66 250 31/46,8	45	2500	
	40	-	2,11 365 31/40,8	2,11 385 31/42,5	3,41 635 31/43,6	3,97 735 31/43,6	9,37 1 560 31/39,1	17,6 3 070 31/40,8	28 4 610 31/38,7	44,5 7 300 31/38,5	55,3 9 420 31/39,9	83,6 14 810 31/41,5	118 20 240 31/40,4	158 28 650 31/42,4	191 33 560 31/41,2	246 42 790 31/40,7	308 53 490 31/40,7	373 67 130 31/42,3	40	2240	
	35,5	-	-	-	-	-	-	-	26,1 4 680 31/37,5	41,9 7 310 31/36,5	55,7 9 670 31/36,3	86 14 150 31/34,4	118 19 930 31/35,4	155 27 350 31/36,9	192 34 020 31/37,2	244 43 540 31/37,4	305 54 420 31/37,4	371 68 040 31/38,4	35,5	2000	
	31,5	-	2 355 31/33,5	2,16 400 31/34,9	4,28 745 31/32,8	5,04 875 31/32,8	8,97 1 550 31/32,6	17,4 3 090 31/33,5	26 4 450 31/32,2	44,4 7 450 31/31,6	51,8 9 010 31/32,8	88,5 14 780 31/31,5	110 17 820 31/30,6	161 28 630 31/33,5	200 34 450 31/32,5	246 43 670 31/33,5	306 54 340 31/33,5	374 68 900 31/34,7	31,5	1800	
	28	-	-	-	-	-	7,12 1 230 21/28,8	-	24 4 160 31/29,1	36,6 6 200 31/28,6	42,7 7 280 31/27,2	90,9 14 770 31/27,3	101 16 470 31/27,3	154 26 340 31/28,7	190 32 680 31/28,8	247 44 290 31/30	307 55 110 31/30	372 67 090 31/30,3	28	1600	
	25	0,77 130 21/24,4	1,81 300 21/24,1	2,05 350 21/25,1	3,23 570 21/26	3,73 660 21/26	8,3 1 340 21/23,7	15,6 2 560 21/24,1	21,8 3 590 21/24,1	33,5 5 620 21/24,6	47,2 8 160 21/25,4	68,6 11 340 21/24,2	96 16 350 21/25	137 23 360 21/25	187 31 390 21/24,6	229 39 030 21/25	282 48 150 21/25	391 68 620 21/25,7	25	1400	
	22,4	-	-	-	-	-	-	-	24,9 4 120 21/21,7	37,3 6 410 21/22,5	50,8 9 050 21/23,3	72,3 12 230 21/22,2	101 17 710 21/23	142 23 800 21/22	202 34 220 21/22,2	232 40 480 21/22,8	284 49 550 21/22,8	418 74 590 21/23,4	22,4	1250	
	20	0,88 150 21/20,1	2,23 365 21/19,3	2,24 385 21/20,1	3,75 665 21/20,8	4,34 770 21/20,8	9,48 1 560 21/19,3	18,6 3 060 21/19,3	26,7 4 470 21/19,6	38,1 6 710 21/20,7	51,1 9 040 21/20,8	76,7 13 310 21/20,3	111 19 010 21/20	159 26 710 21/19,7	202 34 620 21/20,1	245 43 200 21/20,6	327 57 590 21/20,6	435 75 240 21/20,3	20	1120	
	18	-	-	-	-	-	-	-	27,8 4 670 21/17,6	42,3 7 300 21/18,1	54,2 9 320 21/18	84,3 14 160 21/17,6	116 20 050 21/18,1	161 27 320 21/17,8	228 39 030 21/17,9	264 44 780 21/17,8	328 55 740 21/17,8	479 83 590 21/18,3	18	1000	
16	1,02 180 21/16,3	2,3 385 21/15,8	2,47 435 21/16,5	4,45 740 21/15,7	5,26 875 21/15,7	9,96 1 700 21/16,1	20,4 3 420 21/15,8	26,4 4 220 21/15,1	44,8 7 450 21/15,7	51,3 9 040 21/16,6	86,7 14 790 21/16,1	117 19 390 21/15,6	167 28 600 21/16,2	222 37 030 21/15,7	291 49 200 21/15,9	364 61 500 21/15,9	443 75 190 21/16	16	900		
14	-	-	-	-	-	-	-	23,5 4 130 21/14,7	43,7 7 330 21/14,1	57,9 9 950 21/14,4	89,3 14 830 21/13,9	101 17 710 21/14,6	137 23 830 21/14,6	195 34 260 21/14,7	312 53 130 21/14,3	390 66 410 21/14,3	486 83 550 21/14,4	14	800		

For n_1 lower than 560 min⁻¹ see page 107.

▲ Possible forced lubrication with heat exchanger: consult us.

7 - Selection tables (helical gear reducers)



$n_{N2} \cdot L_h$ min ⁻¹ · h	i_N	P_{N2} kW																i_N	n_1	n_{N2} min ⁻¹	
		M_{N2} N m																			
		50	63	64	80	81	100	125	140	160	180	200	225	250	280	320	321				360
710 000	12,5	1,07 175 21/12,3	2,09 365 21/13,1	2,1 385 21/13,6	3,62 665 21/13,7	4,19 770 21/13,7	9,45 1 560 21/12,3	17,5 3 070 21/13,1	25 4 480 21/13,3	36,7 6 700 21/13,6	49,3 9 060 21/13,6	76,4 13 320 21/13	111 19 000 21/12,8	152 26 750 21/13,1	194 34 670 21/13,3	241 43 250 21/13,4	321 57 620 21/13,4	424 75 000 21/13,1	12,5	710	56
	11,2	-	-	-	-	-	-	-	25,9 4 680 21/11,9	40,5 7 300 21/11,9	55,6 9 970 21/11,8	83,5 14 160 21/11,2	115 20 000 21/11,5	152 27 200 21/11,8	217 39 100 21/11,9	257 44 850 21/11,5	320 55 820 21/11,5	467 83 660 21/11,8	11,2	630	
	10	1,14 200 21/10,2	2,11 385 21/10,7	2,27 435 21/11,2	4,24 745 21/10,3	4,98 875 21/10,3	9,74 1 700 21/10,2	18,7 3 430 21/10,7	25,1 4 370 21/10,2	42,5 7 460 21/10,3	54,5 9 930 21/10,7	84,8 14 800 21/10,2	125 21 200 21/9,95	157 28 660 21/10,7	214 37 930 21/10,4	281 49 260 21/10,3	350 61 500 21/10,3	453 82 500 21/10,7	10	560	
630 000	160	-	-	-	-	1 150 31/151	2 300 31/153	-	-	-	-	-	-	-	-	-	-	-			
	125	-	-	-	-	1 400 31/123	2 800 31/123	3 600 31/123	5 300 31/128	7 500 31/131	10 900 31/119	15 000 31/123	21 800 31/125	30 000 31/123	37 500 31/127	45 000 31/127	60 000 31/131				
	100	-	-	-	-	1 450 31/103	2 900 31/101	4 370 31/100	6 500 31/107	9 090 31/108	13 350 31/100	18 500 31/98,5	26 810 31/98,5	34 740 31/100	46 250 31/105	56 000 31/105	66 500 31/103				
	90	-	-	-	-	-	-	4 500 31/89,4	6 700 31/93,7	8 620 31/93,3	13 600 31/86,4	19 000 31/88,8	27 410 31/89	35 390 31/89,7	43 630 31/90,1	54 540 31/90,1	61 770 31/92,7				
	80	-	300 31/75,2	350 31/78,2	530 31/82,7	625 31/82,7	1 320 31/75,5	2 570 31/75,3	4 490 31/81,4	6 740 31/85,7	9 090 31/86,1	13 370 31/84	19 090 31/82,7	26 850 31/82,7	34 800 31/84,3	46 230 31/82,5	57 790 31/82,5	66 180 31/81,1			
	71	-	-	-	-	-	-	4 690 31/72,8	6 900 31/74,9	10 000 31/74,6	14 220 31/72,6	19 500 31/74,5	27 470 31/74,7	35 630 31/75,3	43 630 31/71	54 540 31/71	63 530 31/73				
	63	-	345 31/60,1	385 31/62,6	630 31/66,3	740 31/66,3	1 570 31/61,5	3 070 31/60,2	4 480 31/62	6 730 31/63,5	9 070 31/63,8	13 350 31/62,6	19 060 31/61,7	26 800 31/61,5	34 740 31/62,7	46 280 31/67,1	57 850 31/67,1	66 350 31/66			
	56	-	-	-	-	-	-	24,5 4 630 31/55,4	37,5 7 100 31/55,5	45,6 8 600 31/55,3	76,9 14 200 31/54,1	106 20 110 31/55,5	145 27 420 31/55,6	181 34 660 31/56	222 43 670 31/57,8▲	277 54 590 31/57,8▲	323 65 360 31/59,4▲	56	2800	50	
	50	-	1,88 355 31/49,4	2,21 435 31/51,5	3,92 745 31/49,8	4,61 880 31/49,8	8,19 1 600 31/51,2	16,7 3 150 31/49,5	23,3 4 490 31/50,4	34,7 6 730 31/50,8	46,5 9 070 31/51	66,6 13 380 31/52,6	96,5 19 090 31/51,8	136 26 850 31/51,7	173 34 800 31/52,7	229 46 270 31/52,9	286 57 830 31/52,9	333 66 070 31/52	50	2500	
	45	-	-	-	-	-	-	-	24,4 4 690 31/45,1	38,7 7 320 31/44,4	52,9 9 980 31/44,2	73,4 14 220 31/45,4	101 20 140 31/46,6	138 27 460 31/46,7	173 34 650 31/47,1	225 43 650 31/45,5	281 54 560 31/45,5	336 67 130 31/46,8	45	2240	
	40	-	1,89 370 31/40,8	1,89 385 31/42,5	3,09 640 31/43,6	3,57 745 31/43,6	8,39 1 570 31/39,1	15,8 3 080 31/40,8	25,1 4 630 31/38,7	40,7 7 470 31/38,5	49,6 9 450 31/39,9	74,9 14 860 31/41,5	105 20 310 31/40,4	142 28 750 31/42,4	173 34 020 31/41,2	228 44 270 31/40,7	285 55 340 31/40,7	337 68 040 31/42,3	40	2000	
	35,5	-	-	-	-	-	-	-	23,6 4 690 31/37,5	37,9 7 330 31/36,5	51,8 9 980 31/36,3	77,7 14 190 31/34,4	107 20 110 31/35,4	140 27 440 31/36,9	175 34 450 31/37,2	220 43 680 31/37,4	275 54 600 31/37,4	338 68 900 31/38,4	35,5	1800	
	31,5	-	1,83 365 31/33,5	1,98 410 31/34,9	3,82 745 31/32,8	4,5 880 31/32,8	7,97 1 550 31/32,6	16 3 200 31/33,5	24 4 610 31/32,2	39,6 7 480 31/31,6	47,7 9 330 31/32,8	78,9 14 840 31/31,5	101 18 460 31/30,6	144 28 740 31/33,5	180 34 940 31/32,5	222 44 290 31/33,5	276 55 110 31/33,5	337 69 880 31/34,7	31,5	1600	
	28	-	-	-	-	-	6,25 1 230 21/28,8	-	21,8 4 330 31/29,1	32,5 6 300 31/28,4	37,9 7 400 31/28,6	80,1 14 880 31/27,2	92 17 140 31/27,3	140 27 420 31/28,7	169 33 200 31/28,8	220 45 000 31/30	273 56 000 31/30	330 68 170 31/30,3	28	1400	
	25	0,69 130 21/24,4	1,62 300 21/24,1	1,83 350 21/25,1	2,89 575 21/26	3,34 665 21/26	7,44 1 350 21/23,7	14 2 570 21/24,1	19,6 3 600 21/24,1	30 5 640 21/24,6	42,3 8 190 21/25,4	61,5 11 380 21/24,2	86 16 410 21/25	123 23 440 21/25	168 31 500 21/24,6	211 40 380 21/25	253 48 320 21/25	350 68 860 21/25,7	25	1250	

For n_1 lower than 560 min⁻¹ see page 107.

▲ Possible forced lubrication with heat exchanger: consult us.

7 - Selection tables (helical gear reducers)

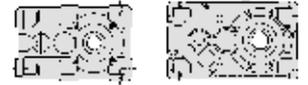

$n_{N2} \cdot L_h$ min ⁻¹ · h	i_N	P_{N2} kW																i_N	n_1 min ⁻¹	n_{N2} min ⁻¹		
		M_{N2} N m																				
		... / i																				
		50	63	64	80	81	100	125	140	160	180	200	225	250	280	320	321	360				
630 000	22,4	-	-	-	-	-	-	-	22,4 4 140 21/21,7	33,5 6 430 21/22,5	45,7 9 090 21/23,3	65 12 280 21/22,2	90,7 17 770 21/23	127 23 890 21/22	182 34 340 21/22,2	211 41 040 21/22,8	255 49 720 21/22,8	376 74 850 21/23,4	22,4	1120	50	
	20	0,79 150 21/20,1	2 370 21/19,3	2,01 385 21/20,1	3,36 670 21/20,8	3,88 775 21/20,8	8,5 1 570 21/19,3	16,7 3 080 21/19,3	23,9 4 480 21/19,6	34,1 6 740 21/20,7	45,8 9 080 21/20,8	68,8 13 360 21/20,3	99,6 19 070 21/20	143 26 810 21/19,7	181 34 740 21/20,1	221 43 480 21/20,6	293 57 790 21/20,6	389 75 510 21/20,3	20	1000		
	18	-	-	-	-	-	-	-	25,1 4 680 21/17,6	38,2 7 330 21/18,1	49 9 350 21/18	76,1 14 200 21/17,6	105 20 120 21/18,1	145 27 410 21/17,8	206 39 160 21/17,9	239 45 000 21/17,8	297 56 000 21/17,8	432 83 870 21/18,3	18	900		
	16	0,91 180 21/16,3	2,05 385 21/15,8	2,2 435 21/16,5	3,97 740 21/15,7	4,69 880 21/15,7	8,86 1 700 21/16,1	18,2 3 430 21/15,8	23,6 4 240 21/15,1	40 7 480 21/15,7	45,8 9 080 21/16,6	77,3 14 850 21/16,1	104 19 460 21/15,6	149 28 710 21/16,2	198 37 170 21/15,7	260 49 390 21/15,9	325 61 730 21/15,9	395 75 470 21/16	16	800		
	14	-	-	-	-	-	-	-	21 4 150 21/14,7	38,9 7 360 21/14,1	51,6 9 990 21/14,4	79,6 14 880 21/13,9	90,4 17 770 21/14,6	122 23 920 21/14,6	174 34 390 21/14,7	278 53 330 21/14,3	347 66 660 21/14,3	433 83 860 21/14,4	14	710		
	12,5	0,95 180 21/12,3	1,86 370 21/13,1	1,87 385 21/13,6	3,22 670 21/13,7	3,73 775 21/13,7	8,41 1 570 21/12,3	15,5 3 070 21/13,1	22,3 4 490 21/13,3	32,5 6 700 21/13,6	43,9 9 090 21/13,6	68,1 13 370 21/13	98,3 19 000 21/12,8	136 26 850 21/13,1	172 34 800 21/13,3	215 43 550 21/13,4	286 57 840 21/13,4	376 75 000 21/13,1	12,5	630		
	11,2	-	-	-	-	-	-	-	23,1 4 700 21/11,9	36 7 300 21/11,9	49,6 10 000 21/11,8	74,5 14 210 21/11,2	102 20 000 21/11,5	135 27 200 21/11,8	193 39 240 21/11,9	229 45 000 21/11,5	286 56 000 21/11,5	416 83 970 21/11,8	11,2	560		
	560 000	160	-	-	-	-	-	1 180 31/151	2 360 31/153	-	-	-	-	-	-	-	-	-	-	-	-	-
125		-	-	-	-	-	1 450 31/123	2 900 31/123	3 620 31/123	5 450 31/128	7 750 31/131	11 420 31/119	15 500 31/123	22 400 31/125	31 610 31/123	38 700 31/127	46 200 31/127	61 500 31/131	-	-	-	-
100		-	-	-	-	-	1 500 31/103	3 000 31/101	4 370 31/100	6 500 31/107	9 120 31/108	13 400 31/100	18 500 31/98,5	26 890 31/98,5	34 860 31/100	46 410 31/105	56 000 31/105	68 640 31/103	-	-	-	-
90		-	-	-	-	-	-	-	4 650 31/89,4	6 700 31/93,7	8 650 31/93,3	13 600 31/86,4	19 500 31/88,8	27 510 31/89	36 660 31/89,7	43 790 31/90,1	54 740 31/90,1	64 000 31/92,7	-	-	-	-
80		-	300 31/75,2	350 31/78,2	530 31/82,7	625 31/82,7	1 350 31/75,5	2 580 31/75,3	4 500 31/81,4	6 770 31/85,7	9 120 31/86,1	13 430 31/84	19 160 31/82,7	26 950 31/82,7	34 930 31/84,3	46 410 31/82,5	58 010 31/82,5	68 590 31/81,1	-	-	-	-
71		-	-	-	-	-	-	-	4 710 31/72,8	6 900 31/74,9	10 040 31/74,6	14 280 31/72,6	20 220 31/74,5	27 570 31/74,7	36 930 31/75,3	43 790 31/71	54 740 31/71	64 450 31/73	-	-	-	-
63		-	1,73 355 31/60,1	1,8 385 31/62,6	2,79 630 31/66,3	3,28 740 31/66,3	7,51 1 570 31/61,5	15 3 090 31/60,2	21,3 4 500 31/62	31,2 6 760 31/63,5	41,8 9 100 31/63,8	62,8 13 400 31/62,6	90,9 19 130 31/61,7	128 26 900 31/61,5	163 34 860 31/62,7	203 46 450 31/67,1▲	254 58 060 31/67,1▲	305 68 740 31/66▲	63	2800	45	
56		-	-	-	-	-	-	-	22 4 640 31/55,4	33,5 7 100 31/55,5	40,9 8 630 31/55,3	68,9 14 250 31/54,1	95,1 20 180 31/55,5	129 27 510 31/55,6	168 35 860 31/56	199 43 830 31/57,8	248 54 780 31/57,8	292 66 250 31/59,4	56	2500		
50		-	1,73 365 31/49,4	1,99 435 31/51,5	3,52 750 31/49,8	4,15 880 31/49,8	7,33 1 600 31/51,2	15,4 3 250 31/49,5	20,9 4 500 31/50,4	31,2 6 760 31/50,8	41,8 9 100 31/51	62,8 13 420 31/52,6	90,9 19 160 31/51,8	122 26 940 31/51,7	156 34 920 31/52,7	206 46 430 31/52,9	257 58 030 31/52,9	308 68 290 31/52	50	2240		
45		-	-	-	-	-	-	-	21,9 4 700 31/45,1	34,7 7 350 31/44,4	47,4 10 020 31/44,2	65,8 14 270 31/45,4	90,8 20 210 31/46,6	124 27 560 31/46,7	160 35 850 31/47,1	202 43 810 31/45,5	252 54 760 31/45,5	304 68 040 31/46,8	45	2000		
40	-	1,71 370 31/40,8	1,71 385 31/42,5	2,81 650 31/43,6	3,25 750 31/43,6	7,58 1 570 31/39,1	14,3 3 090 31/40,8	22,6 4 650 31/38,7	36,7 7 500 31/38,5	44,8 9 480 31/39,9	67,7 14 910 31/41,5	95,1 20 380 31/40,4	128 28 850 31/42,4	158 34 450 31/41,2	211 45 690 31/40,7	264 57 120 31/40,7	307 68 900 31/42,3	40	1800			

For n_1 lower than 560 min⁻¹ see page 107.

▲ Possible forced lubrication with heat exchanger: consult us.

7 - Selection tables (helical gear reducers)



$n_{N2} \cdot L_h$ min ⁻¹ · h	i_N	P_{N2} kW																i_N	n_1	n_{N2} min ⁻¹	
		M_{N2} N m																			
		... / i																			
		50	63	64	80	81	100	125	140	160	180	200	225	250	280	320	321	360			
560 000	35,5	-	-	-	-	-	-	-	21 4 710 3/37,5	33,8 7 360 3/36,5	46,2 10 030 3/36,3	69,3 14 250 3/34,4	95,6 20 180 3/35,4	125 27 540 3/36,9	157 34 940 3/37,2	199 44 290 3/37,4	247 55 110 3/37,4	305 69 880 3/38,4	35,5	1600	45
	31,5	-	1,6 3/33,5	1,73 3/34,9	3,36 3/32,8	3,95 3/32,8	6,98 3/32,6	14,2 3/33,5	21,8 3/32,2	34,8 3/31,6	43,4 3/32,8	69,4 3/31,5	92 3/30,6	126 3/33,5	160 3/32,5	199 3/33,5	249 3/33,5	300 3/34,7	31,5	1400	
	28	-	-	-	-	-	5,6 1 230 2/28,8	-	20,2 4 480 3/29,1	29,1 6 300 3/28,4	34,1 7 440 3/28,6	71,8 14 930 3/27,2	85 17 730 3/27,3	129 28 370 3/28,7	152 33 450 3/28,8	196 45 000 3/30	244 56 000 3/30	297 68 590 3/30,3	28	1250	
	25	0,62 130 2/24,4	1,46 300 2/24,1	1,65 350 2/25,1	2,6 575 2/26	3 665 2/26	6,69 1 350 2/23,7	12,5 2 580 2/24,1	17,6 3 610 2/24,1	27 5 660 2/24,6	38 8 220 2/25,4	55,3 11 420 2/24,2	77,4 16 470 2/25	110 23 530 2/25	151 31 610 2/24,6	193 41 210 2/25	228 48 480 2/25	315 69 100 2/25,7	25	1120	
	22,4	-	-	-	-	-	-	-	20,1 4 150 2/21,7	30,1 6 460 2/22,5	40,9 9 120 2/23,3	58,2 12 320 2/22,2	81,3 17 840 2/23	114 23 970 2/22	163 34 470 2/22,2	194 42 410 2/22,8	229 49 900 2/22,8	337 75 120 2/23,4	22,4	1000	
	20	0,71 150 2/20,1	1,8 370 2/19,3	1,81 385 2/20,1	3,03 670 2/20,8	3,51 775 2/20,8	7,67 1 570 2/19,3	15,1 3 090 2/19,3	21,6 4 500 2/19,6	30,8 6 760 2/20,7	41,3 9 110 2/20,8	62,1 13 410 2/20,3	90 19 140 2/20	129 26 890 2/19,7	164 34 860 2/20,1	199 43 700 2/20,6	265 57 980 2/20,6	352 75 760 2/20,3	20	900	
	18	-	-	-	-	-	-	-	22,4 4 700 2/17,6	34,1 7 350 2/18,1	43,7 9 390 2/18	67,9 14 260 2/17,6	93,7 20 190 2/18,1	129 27 510 2/17,8	184 39 310 2/17,9	212 45 000 2/17,8	264 56 000 2/17,8	386 84 180 2/18,3	18	800	
	16	0,81 180 2/16,3	1,82 385 2/15,8	1,96 435 2/16,5	3,54 745 2/15,7	4,18 880 2/15,7	7,86 1 700 2/16,1	16,2 3 450 2/15,8	21 4 250 2/15,1	35,6 7 500 2/15,7	40,8 9 110 2/16,6	68,9 14 900 2/16,1	92,7 19 500 2/15,6	132 28 820 2/16,2	177 37 310 2/15,7	232 49 570 2/15,9	290 61 960 2/15,9	352 75 760 2/16	16	710	
	14	-	-	-	-	-	-	-	18,7 4 160 2/14,7	34,7 7 390 2/14,1	45,8 10 000 2/14,4	70,9 14 940 2/13,9	80,5 17 840 2/14,6	109 24 010 2/14,6	155 34 500 2/14,7	247 53 530 2/14,3	309 66 910 2/14,3	386 84 180 2/14,4	14	630	
	12,5	0,85 180 2/12,3	1,66 370 2/13,1	1,67 385 2/13,6	2,87 670 2/13,7	3,32 775 2/13,7	7,51 1 570 2/12,3	13,8 3 070 2/13,1	19,8 4 500 2/13,3	28,9 6 700 2/13,6	39,2 9 120 2/13,6	60,7 13 420 2/13	87,3 19 000 2/12,8	121 26 950 2/13,1	154 34 930 2/13,3	192 43 700 2/13,4	255 58 000 2/13,4	335 75 000 2/13,1	12,5	560	
500 000	160	-	-	-	-	-	1 220 3/151	2 430 3/153	-	-	-	-	-	-	-	-	-	-	-	-	-
	125	-	-	-	-	-	1 450 3/123	2 900 3/123	3 630 3/123	5 690 3/128	7 750 3/131	11 460 3/119	15 500 3/123	23 000 3/125	31 720 3/123	38 700 3/127	47 500 3/127	63 000 3/131	-	-	-
	100	-	-	-	-	-	1 500 3/103	3 000 3/101	4 520 3/100	6 700 3/107	9 150 3/108	13 450 3/100	19 200 3/98,5	26 990 3/98,5	34 990 3/100	46 580 3/105	58 220 3/105	71 110 3/103	-	-	-
	90	-	-	-	-	-	-	-	4 660 3/89,4	6 900 3/93,7	8 680 3/93,3	14 300 3/86,4	19 500 3/88,8	27 620 3/89	38 000 3/89,7	43 960 3/90,1	54 950 3/90,1	66 330 3/92,7	-	-	-
	80	-	300 3/75,2	355 3/78,2	535 3/82,7	625 3/82,7	1 360 3/75,5	2 590 3/75,3	4 520 3/81,4	6 790 3/85,7	9 160 3/86,1	13 480 3/84	19 240 3/82,7	27 050 3/82,7	35 060 3/84,3	46 580 3/82,5	58 230 3/82,5	71 090 3/81,1	-	-	-
	71	-	-	-	-	-	-	-	19 4 730 3/72,8	27,8 7 100 3/74,9	39,6 10 080 3/74,6	57,9 14 330 3/72,6	79,9 20 300 3/74,5	109 27 670 3/74,7	149 38 260 3/75,3	182 43 960 3/71	227 54 950 3/71	266 66 280 3/73	71	2800	40
	63	-	1,55 355 3/60,1	1,61 385 3/62,6	2,5 635 3/66,3	2,94 745 3/66,3	6,73 1 580 3/61,5	13,5 3 100 3/60,2	19,1 4 510 3/62	28 6 780 3/63,5	37,5 9 140 3/63,8	56,2 13 450 3/62,6	81,5 19 200 3/61,7	115 26 990 3/61,5	146 34 990 3/62,7	182 46 620 3/61,7	227 58 270 3/61,7	282 71 120 3/66	63	2500	
56	-	-	-	-	-	-	-	19,7 4 660 3/55,4	31,2 7 380 3/55,5	36,8 8 660 3/55,3	62 14 300 3/54,1	85,5 20 250 3/55,5	116 27 610 3/55,6	155 37 060 3/56	179 43 980 3/57,8	223 54 970 3/57,8	265 67 130 3/59,4	56	2240		

For n_1 lower than 560 min⁻¹ see page 107.

7 - Selection tables (helical gear reducers)

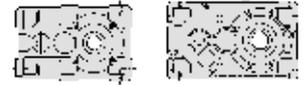

$n_{N2} \cdot L_h$ min ⁻¹ · h	i_N	P_{N2} kW M_{N2} N m ... / i																i_N	n_1 min ⁻¹	n_{N2} min ⁻¹			
		50	63	64	80	81	100	125	140	160	180	200	225	250	280	320	321				360		
500 000	50	-	1,55 365 3I/49,4	1,78 440 3I/51,5	3,16 750 3I/49,8	3,72 885 3I/49,8	6,75 1 650 3I/51,2	13,8 3 250 3I/49,5	18,8 4 520 3I/50,4	28 6 780 3I/50,8	37,5 9 140 3I/51	53,7 13 470 3I/52,6	77,8 19 230 3I/51,8	110 27 040 3I/51,7	139 35 040 3I/52,7	185 46 590 3I/52,9	231 58 240 3I/52,9	285 70 650 3I/52	50	2000	40		
	45	-	-	-	-	-	-	19,7 4 720 3I/45,1	31,3 7 370 3I/44,4	42,8 10 050 3I/44,2	59,4 14 320 3I/45,4	82 20 280 3I/46,6	112 27 650 3I/46,7	148 37 000 3I/47,1	182 43 950 3I/45,5	228 54 940 3I/45,5	277 68 900 3I/46,8	45	1800				
	40	-	1,52 370 3I/40,8	1,53 385 3I/42,5	2,54 660 3I/43,6	2,93 765 3I/43,6	6,76 1 580 3I/39,1	12,7 3 100 3I/40,8	20,2 4 660 3I/38,7	32,8 7 530 3I/38,5	39,9 9 520 3I/39,9	60,4 14 970 3I/41,5	84,8 20 460 3I/40,4	114 28 950 3I/42,4	142 34 940 3I/41,2	195 47 340 3I/40,7	243 59 170 3I/40,7	277 69 880 3I/42,3	40	1600			
	35,5	-	-	-	-	-	-	18,5 4 730 3I/37,5	29,7 7 390 3I/36,5	40,6 10 070 3I/36,3	60,9 14 310 3I/34,4	84 20 270 3I/35,4	110 27 660 3I/36,9	140 35 510 3I/37,2	177 45 000 3I/37,4	220 56 000 3I/37,4	271 71 000 3I/38,4	35,5	1400				
	31,5	-	1,43 365 3I/33,5	1,54 410 3I/34,9	3,01 755 3I/32,8	3,54 885 3I/32,8	6,23 1 550 3I/32,6	12,7 3 250 3I/33,5	20,2 4 960 3I/32,2	31,2 7 540 3I/31,6	40,1 10 050 3I/32,8	62,1 14 950 3I/31,5	85 19 880 3I/30,6	113 28 960 3I/33,5	143 35 500 3I/32,5	184 47 080 3I/33,5	230 58 840 3I/33,5	268 71 000 3I/34,7	31,5	1250			
	28	-	-	-	-	5,04 1 240 2I/28,8	-	18,7 4 630 3I/29,1	26 6 300 3I/28,4	30,7 7 490 3I/28,6	64,6 14 980 3I/27,2	78,7 18 330 3I/27,3	120 29 320 3I/28,7	137 33 690 3I/28,8	176 45 000 3I/30	219 56 000 3I/30	267 68 990 3I/30,3	28	1120				
	25	0,56 130 2I/24,4	1,31 300 2I/24,1	1,48 355 2I/25,1	2,33 580 2I/26	2,69 670 2I/26	5,99 1 360 2I/23,7	11,2 2 590 2I/24,1	15,8 3 630 2I/24,1	24,2 5 680 2I/24,6	34,1 8 250 2I/25,4	49,5 11 460 2I/24,2	69,3 16 530 2I/25	98,9 23 610 2I/25	135 31 720 2I/24,6	173 41 360 2I/25	204 48 660 2I/25	282 69 350 2I/25,7	25	1000			
	22,4	-	-	-	-	-	-	18,1 4 170 2I/21,7	27,1 6 480 2I/22,5	37 9 150 2I/23,3	52,6 12 360 2I/22,2	73,4 17 900 2I/23	103 24 050 2I/22	147 34 580 2I/22,2	176 42 550 2I/22,8	207 50 060 2I/22,8	304 75 370 2I/23,4	22,4	900				
	20	0,63 150 2I/20,1	1,61 370 2I/19,3	1,61 385 2I/20,1	2,69 670 2I/20,8	3,12 775 2I/20,8	6,84 1 580 2I/19,3	13,5 3 100 2I/19,3	19,2 4 510 2I/19,6	27,5 6 780 2I/20,7	36,9 9 140 2I/20,8	55,4 13 460 2I/20,3	80,3 19 210 2I/20	115 26 990 2I/19,7	146 34 990 2I/20,1	179 44 210 2I/20,6	236 58 200 2I/20,6	314 76 040 2I/20,3	20	800			
	18	-	-	-	-	-	-	20 4 720 2I/17,6	30,4 7 380 2I/18,1	38,9 9 420 2I/18	60,5 14 310 2I/17,6	83,5 20 270 2I/18,1	115 27 620 2I/17,8	164 39 460 2I/17,9	188 45 000 2I/17,8	234 56 000 2I/17,8	344 84 500 2I/18,3	18	710				
	16	0,72 180 2I/16,3	1,61 385 2I/15,8	1,75 435 2I/16,5	3,15 750 2I/15,7	3,72 885 2I/15,7	6,97 1 700 2I/16,1	14,4 3 450 2I/15,8	18,6 4 250 2I/15,1	31,6 7 500 2I/15,7	36,3 9 150 2I/16,6	61,4 14 960 2I/16,1	82,3 19 500 2I/15,6	118 28 920 2I/16,2	157 37 450 2I/15,7	206 49 760 2I/15,9	258 62 200 2I/15,9	314 76 040 2I/16	16	630			
	14	-	-	-	-	-	-	16,7 4 180 2I/14,7	30,9 7 420 2I/14,1	40,7 10 000 2I/14,4	63,3 14 990 2I/13,9	71,8 17 910 2I/14,6	96,8 24 100 2I/14,6	138 34 500 2I/14,7	221 53 730 2I/14,3	275 67 000 2I/14,3	344 84 490 2I/14,4	14	560				
	450 000	160	-	-	-	-	1 250 3I/151	2 500 3I/153	-	-	-	-	-	-	-	-	-	-	-				
		125	-	-	-	-	1 500 3I/123	3 000 3I/123	3 640 3I/123	5 710 3I/128	8 000 3I/131	11 500 3I/119	16 000 3I/123	23 690 3I/125	31 830 3I/123	40 000 3I/127	48 840 3I/127	63 000 3I/131					
100		-	-	-	-	1 550 3I/103	3 070 3I/101	4 530 3I/100	6 820 3I/107	9 190 3I/108	13 500 3I/100	19 270 3I/98,5	27 100 3I/98,5	35 120 3I/100	46 750 3I/105	58 440 3I/105	73 700 3I/103						
90		-	-	-	-	-	-	4 680 3I/89,4	6 900 3I/93,7	8 710 3I/93,3	14 360 3I/86,4	20 340 3I/88,8	27 720 3I/89	39 390 3I/89,7	44 120 3I/90,1	55 150 3I/90,1	68 750 3I/92,7						
80		-	1,18 300 3I/75,2	1,33 355 3I/78,2	1,9 535 3I/82,7	2,23 630 3I/82,7	5,3 1 360 3I/75,5	10,1 2 590 3I/75,3	16,3 4 540 3I/81,4	23,3 6 820 3I/85,7	31,3 9 190 3I/86,1	47,2 13 530 3I/84	68,4 19 310 3I/82,7	96,3 27 150 3I/82,7	122 35 190 3I/84,3	166 46 750 3I/82,5	208 58 440 3I/82,5	266 73 650 3I/81,1	80	2800	35,5		
71	-	-	-	-	-	-	17,1 4 740 3I/72,8	24,8 7 100 3I/74,9	35,5 10 110 3I/74,6	51,9 14 380 3I/72,6	71,6 20 370 3I/74,5	97,3 27 770 3I/74,7	138 39 580 3I/75,3	163 44 110 3I/71	203 55 140 3I/71	246 68 580 3I/73	71	2500					

For n_1 lower than 560 min⁻¹ see page 107.

7 - Selection tables (helical gear reducers)



$n_{N2} \cdot L_h$ min ⁻¹ · h	i_N	P_{N2} kW																i_N	n_1	n_{N2} min ⁻¹			
		M_{N2} N m																					
		... / i																					
		50	63	64	80	81	100	125	140	160	180	200	225	250	280	320	321	360					
450 000	63	-	1,45 370 3i/60,1	1,45 385 3i/62,6	2,25 635 3i/66,3	2,64 745 3i/66,3	6,05 1 580 3i/61,5	12,1 3 110 3i/60,2	17,2 4 530 3i/62	25,1 6 800 3i/63,5	33,7 9 170 3i/63,8	50,6 13 500 3i/62,6	73,3 19 260 3i/61,7	103 27 090 3i/61,5	131 35 110 3i/62,7	164 46 780 3i/67,1	204 58 470 3i/67,1	261 73 500 3i/66	63	2240	35,5		
	56	-	-	-	-	-	-	17,7 4 680 3i/55,4	27,9 7 400 3i/55,5	32,9 8 700 3i/55,3	55,5 14 350 3i/54,1	76,6 20 330 3i/55,5	104 27 710 3i/55,6	143 38 340 3i/56	160 44 140 3i/57,8	200 55 170 3i/57,8	241 68 440 3i/59,4	56	2000				
	50	-	1,43 375 3i/49,4	1,61 440 3i/51,5	2,85 755 3i/49,8	3,36 885 3i/49,8	6,08 1 650 3i/51,2	12,8 3 350 3i/49,5	16,9 4 530 3i/50,4	25,2 6 800 3i/50,8	33,9 9 170 3i/51	48,5 13 510 3i/52,6	70,2 19 290 3i/51,8	99 27 130 3i/51,7	126 35 160 3i/52,7	167 46 750 3i/52,9	208 58 440 3i/52,9	264 72 920 3i/52	50	1800			
	45	-	-	-	-	-	-	17,6 4 740 3i/45,1	27,9 7 400 3i/44,4	38,2 10 090 3i/44,2	53 14 370 3i/45,4	73,1 20 360 3i/46,6	99,6 27 750 3i/46,7	136 38 330 3i/47,1	163 44 290 3i/45,5	203 55 140 3i/45,5	250 69 880 3i/46,8	45	1600				
	40	-	1,34 375 3i/40,8	1,34 390 3i/42,5	2,25 670 3i/43,6	2,61 775 3i/43,6	5,94 1 590 3i/39,1	11,2 3 120 3i/40,8	17,8 4 680 3i/38,7	28,8 7 560 3i/38,5	35,1 9 560 3i/39,9	53 15 030 3i/41,5	74,5 20 540 3i/40,4	100 29 080 3i/42,4	126 35 500 3i/41,2	177 49 270 3i/40,7	222 61 590 3i/40,7	246 71 000 3i/42,3	40	1400			
	35,5	-	-	-	-	-	-	16,6 4 750 3i/37,5	26,6 7 410 3i/36,5	36,4 10 110 3i/36,3	54,6 14 360 3i/34,4	75,3 20 340 3i/35,4	98,4 27 760 3i/36,9	129 36 740 3i/37,2	158 45 000 3i/37,4	196 56 000 3i/37,4	242 71 000 3i/38,4	35,5	1250				
	31,5	-	1,28 365 3i/33,5	1,38 410 3i/34,9	2,71 755 3i/32,8	3,18 890 3i/32,8	5,58 1 550 3i/32,6	11,4 3 250 3i/33,5	18,7 5 130 3i/32,2	28,1 7 570 3i/31,6	37,1 10 390 3i/32,8	55,9 15 000 3i/31,5	78,7 20 550 3i/30,6	102 29 060 3i/33,5	128 35 500 3i/32,5	171 48 650 3i/33,5	213 60 820 3i/33,5	240 71 000 3i/34,7	31,5	1120			
	28	-	-	-	-	-	4,52 1 240 2i/28,8	16,6 4 620 3i/29,1	23,2 6 300 3i/28,4	27,6 7 530 3i/28,6	57,8 15 040 3i/27,2	72,7 18 960 3i/27,3	108 29 640 3i/28,7	123 33 930 3i/28,8	158 45 180 3i/30	197 56 480 3i/30	240 69 400 3i/30,3	28	1000				
	25	0,5 130 2i/24,4	1,18 300 2i/24,1	1,33 355 2i/25,1	2,1 580 2i/26	2,43 670 2i/26	5,41 1 360 2i/23,7	10,1 2 590 2i/24,1	14,2 3 640 2i/24,1	21,8 5 700 2i/24,6	30,8 8 280 2i/25,4	44,7 11 500 2i/24,2	62,6 16 580 2i/25	89,3 23 690 2i/25	122 31 830 2i/24,6	156 41 500 2i/25	184 48 820 2i/25	255 69 580 2i/25,7	25	900			
	22,4	-	-	-	-	-	-	16,2 4 180 2i/21,7	24,2 6 500 2i/22,5	33 9 180 2i/23,3	46,9 12 410 2i/22,2	65,5 17 960 2i/23	92 24 140 2i/22	131 34 710 2i/22,2	157 42 710 2i/22,8	184 50 250 2i/22,8	271 75 650 2i/23,4	22,4	800				
	20	0,56 150 2i/20,1	1,43 370 2i/19,3	1,43 385 2i/20,1	2,39 670 2i/20,8	2,77 775 2i/20,8	6,1 1 580 2i/19,3	12 3 110 2i/19,3	17,1 4 530 2i/19,6	24,5 6 810 2i/20,7	32,8 9 180 2i/20,8	49,3 13 510 2i/20,3	71,5 19 280 2i/20	102 27 100 2i/19,7	130 35 120 2i/20,1	165 45 820 2i/20,6	210 58 420 2i/20,6	279 76 330 2i/20,3	20	710			
	18	-	-	-	-	-	-	17,8 4 740 2i/17,6	27 7 410 2i/18,1	34,7 9 460 2i/18	53,9 14 360 2i/17,6	74,4 20 350 2i/18,1	103 27 720 2i/17,8	146 39 600 2i/17,9	167 45 000 2i/17,8	208 56 000 2i/17,8	306 84 820 2i/18,3	18	630				
	16	0,65 180 2i/16,3	1,43 385 2i/15,8	1,55 435 2i/16,5	2,81 750 2i/15,7	3,32 890 2i/15,7	6,2 1 700 2i/16,1	12,8 3 450 2i/15,8	16,6 4 250 2i/15,1	28,1 7 500 2i/15,7	32,4 9 180 2i/16,6	54,7 15 000 2i/16,1	73,1 19 500 2i/15,6	105 29 000 2i/16,2	140 37 500 2i/15,7	184 49 940 2i/15,9	230 62 430 2i/15,9	280 76 330 2i/16	16	560			
	400 000	160	-	-	-	-	1 280 3i/151	2 610 3i/153	-	-	-	-	-	-	-	-	-	-	-				
		125	-	-	-	-	1 500 3i/123	3 000 3i/123	3 650 3i/123	5 730 3i/128	8 000 3i/131	11 540 3i/119	16 000 3i/123	23 780 3i/125	31 950 3i/123	40 000 3i/127	49 020 3i/127	65 000 3i/131					
		100	-	-	-	-	1 550 3i/103	3 070 3i/101	4 550 3i/100	6 840 3i/107	9 220 3i/108	13 550 3i/100	19 340 3i/98,5	27 200 3i/98,5	35 250 3i/100	46 930 3i/105	58 660 3i/105	76 390 3i/103					
90		-	-	-	-	-	-	15,4 4 700 3i/89,4	22,2 7 100 3i/93,7	27,5 8 750 3i/93,3	48,9 14 410 3i/86,4	67,4 20 410 3i/88,8	91,7 27 820 3i/89	130 39 750 3i/89,7	144 44 290 3i/90,1	180 55 360 3i/90,1	225 71 220 3i/92,7	90	2800	31,5			
80	-	1,06 305 3i/75,2	1,19 355 3i/78,2	1,71 540 3i/82,7	2 630 3i/82,7	4,75 1 370 3i/75,5	9,06 2 600 3i/75,3	14,6 4 550 3i/81,4	20,9 6 840 3i/85,7	28 9 220 3i/86,1	42,3 13 570 3i/84	61,3 19 380 3i/82,7	86,3 27 250 3i/82,7	110 35 320 3i/84,3	149 46 920 3i/82,5	186 58 650 3i/82,5	246 76 200 3i/81,1	80	2500				

For n_1 lower than 560 min⁻¹ see page 107.

7 - Selection tables (helical gear reducers)

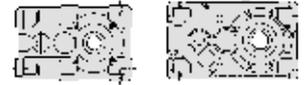

$n_{N2} \cdot L_h$ min ⁻¹ · h	i_N	P_{N2} kW M_{N2} N m ... / i																i_N	n_1 min ⁻¹	n_{N2} min ⁻¹	
		50	63	64	80	81	100	125	140	160	180	200	225	250	280	320	321				360
400 000	71	-	-	-	-	-	-	-	15,3 4 760 3/72,8	22,8 7 300 3/74,9	31,9 10 150 3/74,6	46,6 14 430 3/72,6	64,3 20 440 3/74,5	87,5 27 870 3/74,7	124 39 810 3/75,3	146 44 270 3/71	183 55 330 3/71	228 70 870 3/73	71	2240	31,5
	63	-	1,3 375 3/60,1	1,3 390 3/62,6	2,03 640 3/66,3	2,37 750 3/66,3	5,42 1 590 3/61,5	10,8 3 120 3/60,2	15,4 4 550 3/62	22,5 6 830 3/63,5	30,2 9 200 3/63,8	45,3 13 540 3/62,6	65,7 19 330 3/61,7	92,5 27 180 3/61,5	118 35 240 3/62,7	147 46 940 3/67,1	183 58 680 3/67,1	241 76 040 3/66	63	2000	
	56	-	-	-	-	-	-	16 4 690 3/55,4	25,2 7 430 3/55,5	29,7 8 720 3/55,3	50,2 14 400 3/54,1	69,2 20 390 3/55,5	94,2 27 800 3/55,6	133 39 580 3/56	145 44 280 3/57,8	181 55 350 3/57,8	224 70 640 3/59,4	56	1800		
	50	-	1,31 385 3/49,4	1,43 440 3/51,5	2,54 755 3/49,8	2,99 890 3/49,8	5,57 1 700 3/51,2	11,3 3 350 3/49,5	15,1 4 550 3/50,4	22,5 6 830 3/50,8	30,2 9 200 3/51	43,2 13 560 3/52,6	62,7 19 360 3/51,8	88,3 27 230 3/51,7	112 35 290 3/52,7	149 46 920 3/52,9	186 58 650 3/52,9	243 75 540 3/52	50	1600	
	45	-	-	-	-	-	-	15,5 4 760 3/45,1	24,5 7 430 3/44,4	33,6 10 130 3/44,2	46,6 14 430 3/45,4	64,3 20 440 3/46,6	87,5 27 870 3/46,7	124 39 810 3/47,1	145 45 000 3/45,5	180 56 000 3/45,5	222 71 000 3/46,8	45	1400		
	40	-	1,2 375 3/40,8	1,2 390 3/42,5	2,01 670 3/43,6	2,33 775 3/43,6	5,32 1 590 3/39,1	10 3 130 3/40,8	15,9 4 700 3/38,7	25,8 7 590 3/38,5	31,4 9 590 3/39,9	47,5 15 080 3/41,5	66,8 20 610 3/40,4	90 29 180 3/42,4	115 36 110 3/41,2	161 50 160 3/40,7	201 62 700 3/40,7	220 71 000 3/42,3	40	1250	
	35,5	-	-	-	-	-	-	14,9 4 760 3/37,5	23,9 7 440 3/36,5	32,7 10 140 3/36,3	49,1 14 410 3/34,4	67,7 20 410 3/35,4	88,5 27 860 3/36,9	120 37 970 3/37,2	141 45 000 3/37,4	176 56 000 3/37,4	217 71 000 3/38,4	35,5	1120		
	31,5	-	1,14 365 3/33,5	1,23 410 3/34,9	2,42 760 3/32,8	2,85 890 3/32,8	4,98 1 550 3/32,6	10,1 3 250 3/33,5	16,7 5 150 3/32,2	25,1 7 590 3/31,6	33,6 10 530 3/32,8	50,1 15 060 3/31,5	72,7 21 260 3/30,6	91,1 29 170 3/33,5	114 35 500 3/32,5	157 50 200 3/33,5	196 62 750 3/33,5	214 71 000 3/34,7	31,5	1000	
	28	-	-	-	-	-	4,08 1 250 2/28,8	15 4 620 3/29,1	20,9 6 300 3/28,4	25 7 580 3/28,6	52,2 15 090 3/27,2	67,5 19 570 3/27,3	97,6 29 740 3/28,7	112 34 160 3/28,8	146 46 630 3/30	183 58 290 3/30	217 69 790 3/30,3	28	900		
	25	0,45 130 2/24,4	1,05 305 2/24,1	1,19 355 2/25,1	1,87 580 2/26	2,16 670 2/26	4,83 1 370 2/23,7	9,06 2 600 2/24,1	12,7 3 650 2/24,1	19,5 5 720 2/24,6	27,5 8 310 2/25,4	39,9 11 550 2/24,2	55,8 16 640 2/25	79,7 23 780 2/25	109 31 950 2/24,6	140 41 650 2/25	164 49 000 2/25	227 69 840 2/25,7	25	800	
	22,4	-	-	-	-	-	-	14,4 4 200 2/21,7	21,5 6 500 2/22,5	29,4 9 220 2/23,3	41,8 12 450 2/22,2	58,2 18 000 2/23	81,9 24 230 2/22	117 34 840 2/22,2	140 42 870 2/22,8	164 50 440 2/22,8	242 75 930 2/23,4	22,4	710		
	20	0,5 155 2/20,1	1,28 375 2/19,3	1,27 385 2/20,1	2,12 670 2/20,8	2,45 775 2/20,8	5,43 1 590 2/19,3	10,7 3 120 2/19,3	15,3 4 550 2/19,6	21,8 6 830 2/20,7	29,3 9 210 2/20,8	44 13 560 2/20,3	63,7 19 350 2/20	91,1 27 200 2/19,7	116 35 250 2/20,1	150 46 910 2/20,6	187 58 640 2/20,6	249 76 620 2/20,3	20	630	
	18	-	-	-	-	-	-	15,9 4 750 2/17,6	24,1 7 440 2/18,1	30,9 9 490 2/18	48,1 14 420 2/17,6	66,3 20 420 2/18,1	91,7 27 820 2/17,8	130 39 750 2/17,9	149 45 000 2/17,8	185 56 000 2/17,8	273 85 000 2/18,3	18	560		
	355 000	160	-	-	-	-	1 280 3/151	2 610 3/153	-	-	-	-	-	-	-	-	-	-	-	-	
125		-	-	-	-	1 550 3/123	3 070 3/123	3 670 3/123	5 750 3/128	8 350 3/131	11 580 3/119	16 700 3/123	23 870 3/125	32 070 3/123	41 830 3/127	49 210 3/127	65 000 3/131	-	-	-	
100		-	-	-	-	4,43 1 550 3/103	9,18 3 150 3/101	13,4 4 570 3/100	18,8 6 870 3/107	25,2 9 250 3/108	39,9 13 600 3/98,5	57,8 19 410 3/98,5	81,3 27 300 3/98,5	103 35 380 3/100	132 47 110 3/105	165 58 880 3/105	219 76 940 3/103	100	2800	28	
90		-	-	-	-	-	-	13,8 4 710 3/89,4	19,8 7 100 3/93,7	24,6 8 780 3/93,3	43,8 14 460 3/86,4	60,4 20 480 3/88,8	82,1 27 920 3/89	116 39 890 3/89,7	129 44 450 3/90,1	161 55 560 3/90,1	208 73 690 3/92,7	90	2500		
80		-	0,95 305 3/75,2	1,07 355 3/78,2	1,55 550 3/82,7	1,8 635 3/82,7	4,27 1 370 3/75,5	8,14 2 610 3/75,3	13,2 4 570 3/81,4	18,8 6 870 3/85,7	25,2 9 250 3/86,1	38 13 620 3/84	55,1 19 440 3/82,7	77,6 27 340 3/82,7	98,7 35 440 3/84,3	134 47 080 3/82,5	167 58 850 3/82,5	222 76 900 3/81,1	80		2240

For n_1 lower than 560 min⁻¹ see page 107.

7 - Selection tables (helical gear reducers)



$n_{N2} \cdot L_h$ min ⁻¹ · h	i_N	P_{N2} kW M_{N2} N m ... / i																i_N	n_1 min ⁻¹	n_{N2} min ⁻¹	
		50	63	64	80	81	100	125	140	160	180	200	225	250	280	320	321				360
355 000	71	-	-	-	-	-	-	-	13,7 4 780 31/72,8	20,9 7 470 31/74,9	28,6 10 180 31/74,6	41,8 14 480 31/72,6	57,7 20 520 31/74,5	78,4 27 970 31/74,7	111 39 950 31/75,3	131 44 420 31/71	164 55 530 31/71	210 73 320 31/73	71	2000	28
	63	-	1,17 375 31/60,1	1,17 390 31/62,6	1,85 650 31/66,3	2,14 750 31/66,3	4,89 1 600 31/61,5	9,79 3 130 31/60,2	13,9 4 560 31/62	20,3 6 850 31/63,5	27,3 9 230 31/63,8	40,9 13 590 31/62,6	59,3 19 400 31/61,7	83,5 27 280 31/61,5	106 35 350 31/62,7	132 47 100 31/61,1	165 58 880 31/61,1	220 76 930 31/66	63	1800	
	56	-	-	-	-	-	-	-	14,3 4 710 31/55,4	22,5 7 450 31/55,5	26,5 8 760 31/55,3	44,7 14 450 31/54,1	61,7 20 470 31/55,5	84 27 900 31/55,6	119 39 860 31/56	129 44 450 31/57,8	161 55 560 31/57,8	206 73 180 31/59,4	56	1600	
	50	-	1,15 385 31/49,4	1,26 445 31/51,5	2,24 760 31/49,8	2,63 895 31/49,8	4,87 1 700 31/51,2	10,2 3 450 31/49,5	13,3 4 570 31/50,4	19,8 6 860 31/50,8	26,5 9 240 31/51	38 13 620 31/52,6	55,1 19 440 31/51,8	77,6 27 340 31/51,7	98,7 35 440 31/52,7	131 47 120 31/52,9	163 58 900 31/52,9	217 76 960 31/52	50	1400	
	45	-	-	-	-	-	-	-	13,9 4 770 31/45,1	22 7 460 31/44,4	30,1 10 170 31/44,2	41,7 14 480 31/45,4	57,6 20 520 31/46,6	78,4 27 970 31/46,7	111 39 950 31/47,1	129 45 000 31/45,5	161 56 000 31/45,5	205 73 210 31/46,8	45	1250	
	40	-	1,08 375 31/40,8	1,08 390 31/42,5	1,8 670 31/43,6	2,09 775 31/43,6	4,79 1 600 31/39,1	9,01 3 140 31/40,8	14,3 4 720 31/38,7	23,2 7 610 31/38,5	28,3 9 620 31/39,9	42,7 15 140 31/41,5	60,1 20 690 31/40,4	80,9 29 280 31/42,4	106 37 320 31/41,2	145 50 330 31/40,7	181 62 920 31/40,7	197 71 000 31/42,3	40	1120	
	35,5	-	-	-	-	-	-	-	13,3 4 780 31/37,5	21,4 7 470 31/36,5	29,3 10 180 31/36,3	44 14 460 31/34,4	60,7 20 480 31/35,4	79,3 27 960 31/36,9	111 39 290 31/37,2	126 45 000 31/37,4	157 56 000 31/37,4	197 72 290 31/38,4	35,5	1000	
	31,5	-	1,03 365 31/33,5	1,11 410 31/34,9	2,19 760 31/32,8	2,57 895 31/32,8	4,49 1 550 31/32,6	9,13 3 250 31/33,5	15,1 5 150 31/32,2	22,7 7 620 31/31,6	30,4 10 570 31/32,8	45,2 15 110 31/31,5	67,1 21 800 31/30,6	82,2 29 270 31/33,5	103 35 500 31/32,5	142 50 370 31/33,5	177 62 960 31/33,5	193 71 000 31/34,7	31,5	900	
	28	-	-	-	-	-	3,64 1 250 21/28,8	-	13,7 4 750 31/29,1	18,6 6 300 31/28,4	22,3 7 620 31/28,6	46,6 15 140 31/27,2	62,2 20 270 31/27,3	87,1 29 850 31/28,7	100 34 410 31/28,8	135 48 310 31/30	168 60 390 31/30	194 70 220 31/30,3	28	800	
	25	0,4 130 21/24,4	0,94 305 21/24,1	1,06 355 21/25,1	1,66 580 21/26	1,92 670 21/26	4,3 1 370 21/23,7	8,07 2 610 21/24,1	11,3 3 670 21/24,1	17,4 5 750 21/24,6	24,5 8 340 21/25,4	35,5 11 590 21/24,2	49,7 16 710 21/25	71 23 870 21/25	96,9 32 070 21/24,6	124 41 810 21/25	146 49 190 21/25	202 70 100 21/25,7	25	710	
	22,4	-	-	-	-	-	-	-	12,8 4 210 21/21,7	19,1 6 500 21/22,5	26,2 9 250 21/23,3	37,2 12 500 21/22,2	51,7 18 000 21/23	72,9 24 300 21/22	104 34 970 21/22,2	124 43 030 21/22,8	146 50 630 21/22,8	215 76 220 21/23,4	22,4	630	
	20	0,45 155 21/20,1	1,14 375 21/19,3	1,13 385 21/20,1	1,89 670 21/20,8	2,18 775 21/20,8	4,85 1 600 21/19,3	9,53 3 130 21/19,3	13,6 4 560 21/19,6	19,5 6 860 21/20,7	26,1 9 240 21/20,8	39,2 13 600 21/20,3	56,8 19 420 21/20	81 27 200 21/19,7	103 35 380 21/20,1	134 47 080 21/20,6	167 58 860 21/20,6	222 76 900 21/20,3	20	560	
315 000	160	-	-	-	-	1 320 31/151	2 620 31/153	-	-	-	-	-	-	-	-	-	-	-	-	-	-
	125	-	-	-	-	1 550 31/123	3 140 31/123	3 680 31/123	5 770 31/128	8 380 31/131	11 630 31/119	16 760 31/123	23 960 31/125	32 190 31/123	41 980 31/127	49 390 31/127	67 000 31/131	-	-	-	-
	100	-	-	-	-	4,08 1 600 31/103	8,19 3 150 31/101	12 4 580 31/100	16,8 6 890 31/107	22,6 9 290 31/108	35,7 13 650 31/100	51,8 19 480 31/98,5	72,8 27 400 31/98,5	92,6 35 510 31/100	118 47 270 31/105	148 59 090 31/105	196 77 210 31/103	100	2500	25	
	90	-	-	-	-	-	-	12,4 4 730 31/89,4	18,3 7 300 31/93,7	22,2 8 810 31/93,3	39,4 14 510 31/86,4	54,3 20 550 31/88,8	73,9 28 020 31/89	105 40 030 31/89,7	116 44 600 31/90,1	145 55 750 31/90,1	193 76 150 31/92,7	90	2240		
	80	-	0,85 305 31/75,2	0,96 360 31/78,2	1,41 555 31/82,7	1,63 640 31/82,7	3,82 1 380 31/75,5	7,3 2 620 31/75,3	11,8 4 590 31/81,4	16,8 6 890 31/85,7	22,6 9 290 31/86,1	34,1 13 670 31/84	49,4 19 510 31/82,7	69,5 27 440 31/82,7	88,4 35 560 31/84,3	120 47 250 31/82,5	150 59 060 31/82,5	199 77 170 31/81,1	80		2000
	71	-	-	-	-	-	-	-	12,4 4 790 31/72,8	18,9 7 500 31/74,9	25,8 10 220 31/74,6	37,7 14 530 31/72,6	52,1 20 580 31/74,5	70,8 28 060 31/74,7	100 40 090 31/75,3	118 44 570 31/71	148 55 710 31/71	195 75 680 31/73	71		1800

For n_1 lower than 560 min⁻¹ see page 107.

7 - Selection tables (helical gear reducers)

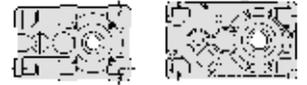

$n_{N2} \cdot L_h$ min ⁻¹ · h	i_N	P_{N2} kW																i_N	n_1	n_{N2}		
		M_{N2} N m																				
		... / i																				
		50	63	64	80	81	100	125	140	160	180	200	225	250	280	320	321	360				
315 000	63	-	1,05 375 3i/60,1	1,05 390 3i/62,6	1,67 660 3i/66,3	1,93 765 3i/66,3	4,37 1 600 3i/61,5	8,74 3 140 3i/60,2	12,4 4 580 3i/62	18,1 6 880 3i/63,5	24,3 9 270 3i/63,8	36,5 13 640 3i/62,6	52,9 19 470 3i/61,7	74,5 27 380 3i/61,5	94,8 35 480 3i/62,7	118 47 280 3i/67,1	148 59 090 3i/67,1	196 77 210 3i/66	63	1600	25	
	56	-	-	-	-	-	-	12,5 4 730 3i/55,4	19,8 7 490 3i/55,5	23,3 8 790 3i/55,3	39,3 14 510 3i/54,1	54,3 20 560 3i/55,5	73,9 28 020 3i/55,6	105 40 030 3i/56	114 45 000 3i/57,8	142 56 000 3i/57,8	188 76 170 3i/59,4	56	1400			
	50	-	1,03 385 3i/49,4	1,13 445 3i/51,5	2 765 3i/49,8	2,36 900 3i/49,8	4,35 1 700 3i/51,2	9,13 3 450 3i/49,5	11,9 4 580 3i/50,4	17,7 6 880 3i/50,8	23,8 9 270 3i/51	34 13 670 3i/52,6	49,3 19 510 3i/51,8	69,5 27 440 3i/51,7	88,4 35 560 3i/52,7	117 47 290 3i/52,9	146 59 110 3i/52,9	194 77 230 3i/52	50	1250		
	45	-	-	-	-	-	-	-	12,5 4 790 3i/45,1	19,8 7 490 3i/44,4	27,1 10 200 3i/44,2	37,5 14 530 3i/45,4	51,8 20 590 3i/46,6	70,5 28 060 3i/46,7	99,9 40 090 3i/47,1	116 45 000 3i/45,5	144 56 000 3i/45,5	190 75 660 3i/46,8	45	1120		
	40	-	0,97 375 3i/40,8	0,97 390 3i/42,5	1,61 670 3i/43,6	1,86 775 3i/43,6	4,29 1 600 3i/39,1	8,08 3 150 3i/40,8	12,8 4 730 3i/38,7	20,8 7 640 3i/39,9	25,3 9 660 3i/41,5	38,3 15 190 3i/41,5	53,8 20 760 3i/40,4	72,5 29 390 3i/42,4	98,2 38 620 3i/41,2	130 50 510 3i/40,7	162 63 140 3i/40,7	176 71 000 3i/42,3	40	1000		
	35,5	-	-	-	-	-	-	-	12 4 800 3i/37,5	19,3 7 490 3i/36,5	26,5 10 210 3i/36,3	39,7 14 510 3i/34,4	54,8 20 550 3i/35,4	71,6 28 050 3i/36,9	102 40 070 3i/37,2	113 45 000 3i/37,4	141 56 000 3i/37,4	183 74 610 3i/38,4	35,5	900		
	31,5	-	0,91 365 3i/33,5	0,99 410 3i/34,9	1,95 765 3i/32,8	2,3 900 3i/32,8	3,99 1 550 3i/32,6	8,12 3 250 3i/33,5	13,4 5 150 3i/32,2	20,3 7 650 3i/31,6	27,1 10 610 3i/32,8	40,3 15 160 3i/31,5	59,6 21 800 3i/30,6	73,4 29 370 3i/33,5	94,6 36 750 3i/32,5	127 50 550 3i/33,5	158 63 190 3i/33,5	171 71 000 3i/34,7	31,5	800		
	28	-	-	-	-	-	3,24 1 260 2i/28,8	-	12,1 4 750 3i/29,1	16,5 6 300 3i/28,4	20 7 670 3i/28,6	41,5 15 200 3i/27,2	55,9 20 530 3i/27,3	77,6 29 960 3i/28,7	89,4 34 670 3i/28,8	124 50 070 3i/30	155 62 590 3i/30	174 70 650 3i/30,3	28	710		
	25	0,36 130 2i/24,4	0,84 305 2i/24,1	0,94 360 2i/25,1	1,47 580 2i/26	1,7 670 2i/26	3,83 1 380 2i/23,7	7,19 2 620 2i/24,1	10,1 3 680 2i/24,1	15,5 5 770 2i/24,6	21,8 8 370 2i/25,4	31,7 11 630 2i/24,2	44,3 16 770 2i/25	63,2 23 960 2i/25	86,3 32 190 2i/24,6	111 41 970 2i/25	130 49 370 2i/25	180 70 370 2i/25,7	25	630		
	22,4	-	-	-	-	-	-	-	11,4 4 230 2i/21,7	16,9 6 500 2i/22,5	23,2 9 250 2i/23,3	33,1 12 500 2i/22,2	45,9 18 000 2i/23	64,8 24 300 2i/22	92,9 35 100 2i/22,2	111 43 190 2i/22,8	130 50 820 2i/22,8	192 76 500 2i/23,4	22,4	560		
	280 000	160	-	-	-	-	-	1 320 3i/151	2 630 3i/153	-	-	-	-	-	-	-	-	-	-			
		125	-	-	-	-	-	3,82 1 610 3i/123	7,55 3 160 3i/123	8,83 3 700 3i/123	13,3 5 790 3i/128	18,8 8 410 3i/119	28,7 11 670 3i/119	40,2 16 820 3i/123	56,4 24 040 3i/125	77 32 310 3i/123	97,5 42 140 3i/127	115 49 580 3i/127	150 67 000 3i/131	125	2800	22,4
100		-	-	-	-	-	3,66 1 600 3i/103	7,57 3 250 3i/101	10,8 4 600 3i/100	15,1 6 920 3i/107	20,3 9 320 3i/108	32,1 13 700 3i/100	46,5 19 550 3i/98,5	65,5 27 490 3i/98,5	83,3 35 630 3i/100	106 47 440 3i/105	133 59 300 3i/105	176 77 480 3i/103	100	2240		
90		-	-	-	-	-	-	-	11,1 4 750 3i/89,4	16,8 7 530 3i/93,7	19,8 8 840 3i/93,3	35,3 14 560 3i/86,4	48,7 20 630 3i/88,8	66,2 28 120 3i/89	93,8 40 180 3i/89,7	104 44 760 3i/90,1	130 55 950 3i/90,1	178 78 790 3i/92,7	90	2000		
80		-	0,77 305 3i/75,2	0,87 360 3i/78,2	1,28 565 3i/82,7	1,48 650 3i/82,7	3,45 1 380 3i/75,5	6,59 2 630 3i/75,3	10,7 4 600 3i/81,4	15,2 6 910 3i/85,7	20,4 9 320 3i/86,1	30,8 13 720 3i/84	44,6 19 580 3i/82,7	62,8 27 530 3i/82,7	79,8 35 680 3i/84,3	108 47 410 3i/82,5	135 59 260 3i/82,5	180 77 430 3i/81,1	80	1800		
71		-	-	-	-	-	-	-	11,1 4 810 3i/72,8	16,8 7 530 3i/74,9	23 10 260 3i/74,6	33,7 14 580 3i/72,6	46,5 20 660 3i/74,5	63,2 28 160 3i/74,7	89,5 40 240 3i/75,3	106 44 740 3i/71	132 55 920 3i/71	180 78 400 3i/73	71	1600		
63		-	0,92 375 3i/60,1	0,92 395 3i/62,6	1,48 670 3i/66,3	1,71 775 3i/66,3	3,84 1 610 3i/61,5	7,68 3 150 3i/60,2	10,9 4 600 3i/62	15,9 6 900 3i/63,5	21,4 9 300 3i/63,8	32,1 13 700 3i/62,6	46,5 19 550 3i/61,7	65,5 27 490 3i/61,5	83,3 35 630 3i/62,7	104 47 470 3i/67,1	130 59 340 3i/67,1	172 77 540 3i/66	63	1400		
56		-	-	-	-	-	-	-	11,2 4 750 3i/55,4	17,7 7 510 3i/55,5	20,9 8 830 3i/55,3	35,2 14 560 3i/54,1	48,6 20 630 3i/55,5	66,2 28 120 3i/55,6	93,8 40 180 3i/56	102 45 000 3i/57,8	127 56 000 3i/57,8	174 78 800 3i/59,4	56	1250		

For n_1 lower than 560 min⁻¹ see page 107.

7 - Selection tables (helical gear units)



$n_{N2} \cdot L_h$ min ⁻¹ · h	i_N	P_{N2} kW																i_N	n_1	n_{N2} min ⁻¹		
		M_{N2} N m																				
		... / i																				
		50	63	64	80	81	100	125	140	160	180	200	225	250	280	320	321	360				
280 000	50	-	0,92 385 3i/49,4	1,01 445 3i/51,5	1,8 765 3i/49,8	2,12 900 3i/49,8	3,9 1 700 3i/51,2	8,18 3 450 3i/49,5	10,7 4 600 3i/50,4	15,9 6 900 3i/50,8	21,4 9 300 3i/51	30,6 13 720 3i/52,6	44,4 19 580 3i/51,8	62,5 27 530 3i/51,7	79,5 35 690 3i/52,7	105 47 450 3i/52,9	132 59 310 3i/52,9	175 77 500 3i/52	50	1120	22,4	
	45	-	-	-	-	-	-	11,2 4 810 3i/45,1	17,7 7 510 3i/44,4	24,2 10 240 3i/44,2	33,6 14 580 3i/45,4	46,4 20 660 3i/46,6	63,2 28 160 3i/46,7	89,5 40 240 3i/47,1	104 45 000 3i/45,5	129 56 000 3i/45,5	175 78 280 3i/46,8	45	1000			
	40	-	0,87 380 3i/40,8	0,87 395 3i/42,5	1,45 670 3i/43,6	1,68 775 3i/43,6	3,87 1 610 3i/39,1	7,29 3 160 3i/40,8	11,6 4 750 3i/38,7	18,8 7 670 3i/38,5	22,9 9 690 3i/39,9	34,6 15 240 3i/41,5	48,6 20 830 3i/40,4	65,5 29 480 3i/42,4	91,2 39 860 3i/41,2	117 50 680 3i/40,7	147 63 350 3i/40,7	163 72 940 3i/42,3	40	900		
	35,5	-	-	-	-	-	-	10,7 4 810 3i/37,5	17,3 7 520 3i/36,5	23,6 10 250 3i/36,3	35,4 14 560 3i/34,4	48,9 20 630 3i/35,4	63,9 28 150 3i/36,9	90,6 40 220 3i/37,2	101 45 000 3i/37,4	126 56 010 3i/37,4	168 77 290 3i/38,4	35,5	800			
	31,5	-	0,81 365 3i/33,5	0,88 410 3i/34,9	1,74 765 3i/32,8	2,05 900 3i/32,8	3,54 1 550 3i/32,6	7,2 3 250 3i/33,5	11,9 5 150 3i/32,2	18 7 670 3i/31,6	24,1 10 650 3i/32,8	35,9 15 220 3i/31,5	52,9 21 800 3i/30,6	65,4 29 480 3i/33,5	87 38 090 3i/32,5	113 50 760 3i/33,5	141 63 450 3i/33,5	155 72 320 3i/34,7	31,5	710		
	28	-	-	-	-	-	2,89 1 260 2i/28,8	-	10,8 4 750 3i/29,1	14,6 6 300 3i/28,4	17,8 7 720 3i/28,6	37,1 15 290 3i/27,2	49,7 20 600 3i/27,3	69,8 30 360 3i/28,7	80,1 34 980 3i/28,8	114 51 900 3i/30	142 64 870 3i/30	155 71 000 3i/30,3	28	630		
	25	0,32 130 2i/24,4	0,75 305 2i/24,1	0,84 360 2i/25,1	1,31 580 2i/26	1,51 670 2i/26	3,42 1 380 2i/23,7	6,41 2 630 2i/24,1	8,99 3 690 2i/24,1	13,8 5 790 2i/24,6	19,4 8 400 2i/25,4	28,2 11 680 2i/24,2	39,5 16 830 2i/25	56,4 24 040 2i/25	77 32 310 2i/24,6	98,8 42 120 2i/25	116 49 550 2i/25	161 70 630 2i/25,7	25	560		
	250 000	160	-	-	-	-	1 360 3i/151	2 640 3i/153	-	-	-	-	-	-	-	-	-	-	-			
		125	-	-	-	-	3,43 1 610 3i/123	6,77 3 170 3i/123	7,92 3 710 3i/123	11,9 5 820 3i/128	16,8 8 440 3i/131	25,7 11 710 3i/119	36 16 880 3i/123	50,5 24 130 3i/125	69 32 420 3i/123	87,3 42 290 3i/127	103 49 750 3i/127	138 69 000 3i/131	125	2500	20	
		100	-	-	-	-	3,37 1 650 3i/103	6,76 3 250 3i/101	9,67 4 620 3i/100	13,6 6 940 3i/107	18,2 9 350 3i/108	28,8 13 750 3i/100	41,7 19 620 3i/98,5	58,7 27 590 3i/98,5	74,6 35 760 3i/100	95,2 47 610 3i/105	119 59 510 3i/105	158 77 750 3i/103	100	2000		
90		-	-	-	-	-	-	10 4 760 3i/89,4	15,2 7 550 3i/93,7	17,9 8 870 3i/93,3	31,9 14 610 3i/86,4	44 20 700 3i/88,8	59,8 28 210 3i/89	84,7 40 310 3i/89,7	93,9 44 910 3i/90,1	117 56 130 3i/90,1	163 80 290 3i/92,7	90	1800			
80		-	0,68 305 3i/75,2	0,77 360 3i/78,2	1,16 570 3i/82,7	1,34 660 3i/82,7	3,08 1 390 3i/75,5	5,88 2 640 3i/75,3	9,5 4 620 3i/81,4	13,6 6 940 3i/85,7	18,2 9 350 3i/86,1	27,5 13 770 3i/84	39,8 19 650 3i/82,7	56 27 630 3i/82,7	71,2 35 820 3i/84,3	96,6 47 580 3i/82,5	121 59 480 3i/82,5	160 77 720 3i/81,1	80	1600		
71		-	-	-	-	-	-	9,73 4 830 3i/72,8	14,8 7 560 3i/74,9	20,2 10 300 3i/74,6	29,6 14 650 3i/72,6	40,8 20 750 3i/74,5	55,5 28 280 3i/74,7	78,7 40 410 3i/75,3	92,9 45 000 3i/71	116 56 160 3i/71	164 81 610 3i/73	71	1400			
63		-	0,82 380 3i/60,1	0,82 395 3i/62,6	1,32 670 3i/66,3	1,53 775 3i/66,3	3,44 1 610 3i/61,5	6,88 3 170 3i/60,2	9,75 4 610 3i/62	14,3 6 930 3i/63,5	19,2 9 340 3i/63,8	28,7 13 750 3i/62,6	41,6 19 620 3i/61,7	58,7 27 590 3i/61,5	74,6 35 760 3i/62,7	92,9 47 640 3i/67,1	116 59 560 3i/67,1	154 77 820 3i/66	63	1250		
56		-	-	-	-	-	-	10,1 4 760 3i/55,4	15,9 7 540 3i/55,5	18,8 8 860 3i/55,3	31,7 14 610 3i/54,1	43,7 20 700 3i/55,5	59,5 28 220 3i/55,6	84,4 40 310 3i/56	91,4 45 000 3i/57,8	114 56 190 3i/57,8	159 80 360 3i/59,4	56	1120			
50		-	0,82 385 3i/49,4	0,91 450 3i/51,5	1,63 775 3i/49,8	1,91 910 3i/49,8	3,48 1 700 3i/51,2	7,3 3 450 3i/49,5	9,58 4 620 3i/50,4	14,3 6 930 3i/50,8	19,2 9 340 3i/51	27,4 13 770 3i/52,6	39,7 19 650 3i/51,8	56 27 630 3i/51,7	71,2 35 820 3i/52,7	94,3 47 620 3i/52,9	118 59 530 3i/52,9	157 77 780 3i/52	50	1000		
45		-	-	-	-	-	-	10,1 4 820 3i/45,1	16 7 540 3i/44,4	21,9 10 270 3i/44,2	30,4 14 630 3i/45,4	41,9 20 730 3i/46,6	57 28 260 3i/46,7	80,9 40 370 3i/47,1	93,2 45 000 3i/45,5	116 56 150 3i/45,5	163 80 790 3i/46,8	45	900			
40	-	0,78 380 3i/40,8	0,78 395 3i/42,5	1,29 670 3i/43,6	1,49 775 3i/43,6	3,46 1 610 3i/39,1	6,51 3 170 3i/40,8	10,3 4 770 3i/38,7	16,8 7 720 3i/38,5	20,4 9 730 3i/39,9	31,1 15 400 3i/41,5	43,4 20 910 3i/40,4	58,9 29 850 3i/42,4	83,6 41 080 3i/41,2	106 51 360 3i/40,7	132 64 200 3i/40,7	150 75 560 3i/42,3	40	800			

For n_1 lower than 560 min⁻¹ see page 107.

7 - Selection tables (helical gear units)



$n_{N2} \cdot L_h$ min ⁻¹ · h	i_N	P_{N2} kW																i_N	n_1	n_{N2} min ⁻¹			
		M_{N2} N m																					
		50	63	64	80	81	100	125	140	160	180	200	225	250	280	320	321				360		
250 000	35,5	-	-	-	-	-	-	9,57 4 830 31/37,5	15,4 7 550 31/36,5	21,1 10 290 31/36,3	31,6 14 610 31/34,4	43,5 20 700 31/35,4	56,9 28 260 31/36,9	80,7 40 370 31/37,2	89,5 45 000 31/37,4	112 56 240 31/37,4	155 80 110 31/38,4	35,5	710	20			
	31,5	-	0,72 365 31/33,5	0,78 410 31/34,9	1,57 780 31/32,8	1,85 915 31/32,8	3,14 1 550 31/32,6	6,39 3 250 31/33,5	10,6 5 150 31/32,2	16,2 7 750 31/31,6	21,5 10 690 31/32,8	32,1 15 320 31/31,5	47 21 800 31/30,6	58,7 29 870 31/33,5	80,1 39 490 31/32,5	102 51 690 31/33,5	127 64 610 31/33,5	142 74 960 31/34,7	31,5		630		
	28	-	-	-	-	-	2,58 1 270 21/28,8	-	9,58 4 750 31/29,1	13 6 300 31/28,4	15,9 7 750 31/28,6	33,4 15 500 31/27,2	44,2 20 600 31/27,3	63,1 30 900 31/28,7	73,7 36 230 31/28,8	105 53 760 31/30	131 67 210 31/30	138 71 000 31/30,3	28		560		
224 000	160	-	-	-	-	-	2,7 1 390 31/151	5,08 2 650 31/153	-	-	-	-	-	-	-	-	-	-	160	2800	18		
	125	-	-	-	-	-	3,08 1 620 31/123	6,08 3 180 31/123	7,12 3 720 31/123	10,7 5 840 31/128	15,1 8 470 31/131	23,1 11 750 31/119	32,4 16 940 31/123	45,4 24 210 31/125	62 32 540 31/123	78,5 42 440 31/127	92,4 49 930 31/127	124 69 000 31/131	125	2240			
	100	-	-	-	-	-	3,03 1 650 31/103	6,27 3 350 31/101	8,73 4 630 31/100	12,3 6 960 31/107	16,4 9 380 31/108	26 13 790 31/100	37,7 19 690 31/98,5	53 27 680 31/98,5	67,4 35 880 31/100	86 47 760 31/105	107 59 710 31/105	143 78 010 31/103	100	1800			
	90	-	-	-	-	-	-	-	8,96 4 780 31/89,4	13,7 7 650 31/93,7	16 8 900 31/93,3	28,4 14 680 31/86,4	39,3 20 800 31/88,8	53,5 28 400 31/89	75,8 40 580 31/89,7	84,5 45 460 31/90,1	106 56 820 31/90,1	146 80 590 31/92,7	90	1600			
	80	-	0,6 310 31/75,2	0,68 360 31/78,2	1,03 580 31/82,7	1,19 670 31/82,7	2,71 1 390 31/75,5	5,16 2 650 31/75,3	8,35 4 640 31/81,4	11,9 6 970 31/85,7	16 9 390 31/86,1	24,1 13 820 31/84	35 19 730 31/82,7	49,2 27 750 31/82,7	62,6 35 970 31/84,3	84,9 47 780 31/82,5	106 59 730 31/82,5	141 78 040 31/81,1	80	1400			
	71	-	-	-	-	-	-	-	8,79 4 880 31/72,8	13,4 7 680 31/74,9	18,4 10 460 31/74,6	26,8 14 840 31/72,6	36,9 21 020 31/74,5	50,3 28 720 31/74,7	71,3 41 030 31/75,3	83,9 45 510 31/71	105 56 890 31/71	151 84 430 31/73	71	1250			
	63	-	0,74 380 31/60,1	0,74 395 31/62,6	1,19 670 31/66,3	1,37 775 31/66,3	3,09 1 620 31/61,5	6,19 3 180 31/60,2	8,77 4 630 31/62	12,8 6 950 31/63,5	17,2 9 370 31/63,8	25,8 13 790 31/62,6	37,4 19 690 31/61,7	52,8 27 690 31/61,5	67,1 35 880 31/62,7	83,6 47 810 31/67,1	104 59 760 31/67,1	139 78 090 31/66	63	1120			
	56	-	-	-	-	-	-	-	9,04 4 780 31/55,4	14,3 7 590 31/55,5	16,8 8 890 31/55,3	28,4 14 680 31/54,1	39,2 20 800 31/55,5	53,5 28 400 31/55,6	75,8 40 580 31/56	82,7 45 630 31/57,8	103 57 030 31/57,8	142 80 650 31/59,4	56	1000			
	50	-	0,74 385 31/49,4	0,83 455 31/51,5	1,49 785 31/49,8	1,75 925 31/49,8	3,13 1 700 31/51,2	6,57 3 450 31/49,5	8,65 4 630 31/50,4	12,9 6 950 31/50,8	17,3 9 370 31/51	24,8 13 810 31/52,6	35,9 19 720 31/51,8	50,6 27 720 31/51,7	64,3 35 930 31/52,7	85,2 47 780 31/52,9	106 59 720 31/52,9	141 78 040 31/52	50	900			
	45	-	-	-	-	-	-	-	9,03 4 860 31/45,1	14,3 7 590 31/44,4	19,6 10 340 31/44,2	27,3 14 790 31/45,4	37,6 20 950 31/46,6	51,3 28 610 31/46,7	72,8 40 880 31/47,1	83,8 45 520 31/45,5	105 56 900 31/45,5	150 83 700 31/46,8	45	800			
	40	-	0,69 380 31/40,8	0,69 395 31/42,5	1,14 670 31/43,6	1,32 775 31/43,6	3,08 1 620 31/39,1	5,8 3 180 31/40,8	9,2 4 780 31/38,7	15 7 750 31/38,5	18,2 9 750 31/39,9	27,7 15 500 31/41,5	38,6 20 990 31/40,4	53,3 30 400 31/42,4	75,4 41 770 31/41,2	95,4 52 290 31/40,7	119 65 370 31/40,7	138 78 320 31/42,3	40	710			
	35,5	-	-	-	-	-	-	-	8,61 4 900 31/37,5	13,8 7 640 31/36,5	18,9 10 410 31/36,3	28,2 14 710 31/34,4	38,9 20 830 31/35,4	51,2 28 630 31/36,9	72,6 40 900 31/37,2	80,9 45 810 31/37,4	101 57 270 31/37,4	142 83 040 31/38,4	35,5	630			
	31,5	-	0,64 365 31/33,5	0,69 410 31/34,9	1,42 795 31/32,8	1,66 925 31/32,8	2,79 1 550 31/32,6	5,68 3 250 31/33,5	9,38 5 150 31/32,2	14,4 7 750 31/31,6	19,2 10 730 31/32,8	28,9 15 500 31/31,5	41,7 21 800 31/30,6	53,2 30 410 31/33,5	73,7 40 910 31/32,5	92,2 52 620 31/33,5	115 65 770 31/33,5	131 77 660 31/34,7	31,5	560			
	200 000	160	-	-	-	-	-	2,42 1 400 31/151	4,55 2 660 31/153	-	-	-	-	-	-	-	-	-	-	160		2500	16
		125	-	-	-	-	-	2,78 1 630 31/123	5,47 3 200 31/123	6,38 3 730 31/123	9,62 5 860 31/128	13,6 8 500 31/131	20,7 11 790 31/119	29 17 000 31/123	40,7 24 300 31/125	55,6 32 650 31/123	70,4 42 590 31/127	82,8 50 100 31/127	115 71 410 31/131	125		2000	

For n_1 lower than 560 min⁻¹ see page 107.

7 - Selection tables (helical gear reducers)



$n_{N2} \cdot L_h$ min ⁻¹ · h	i_N	P_{N2} kW M_{N2} N m ... / i																i_N	n_1 min ⁻¹	n_{N2} min ⁻¹	
		50	63	64	80	81	100	125	140	160	180	200	225	250	280	320	321				360
200 000	100	-	-	-	-	-	2,77 1 700 3/103	5,58 3 350 3/101	7,81 4 660 3/100	11 7 050 3/107	14,8 9 510 3/108	23,2 13 860 3/100	33,6 19 780 3/98,5	47,4 27 870 3/98,5	60,3 36 120 3/100	77,4 48 350 3/105	96,7 60 430 3/105	128 78 960 3/103	100	1600	16
	90	-	-	-	-	-	-	7,88 4 800 3/89,4	12,1 7 750 3/93,7	14,1 8 940 3/93,3	25,4 14 980 3/86,4	35 21 220 3/88,8	47,7 28 980 3/89	67,7 41 410 3/89,7	75,5 46 380 3/90,1	94,3 57 980 3/90,1	128 80 930 3/92,7	90	1400		
	80	-	0,54 310 3/75,2	0,61 365 3/78,2	0,92 580 3/82,7	1,06 670 3/82,7	2,43 1 400 3/75,5	4,63 2 660 3/75,3	7,54 4 690 3/81,4	10,8 7 080 3/85,7	14,5 9 540 3/86,1	21,8 14 010 3/84	31,6 20 000 3/82,7	44,6 28 170 3/82,7	56,7 36 520 3/84,3	76,8 48 410 3/82,5	96 60 510 3/82,5	128 79 070 3/81,1	80	1250	
	71	-	-	-	-	-	-	8 4 970 3/72,8	12,1 7 750 3/74,9	16,7 10 640 3/74,6	24,4 15 090 3/72,6	33,6 21 370 3/74,5	45,8 29 200 3/74,7	65 41 710 3/75,3	76,4 46 280 3/71	95,5 57 840 3/71	140 87 260 3/73	71	1120		
	63	-	0,66 380 3/60,1	0,66 395 3/62,6	1,06 670 3/66,3	1,22 775 3/66,3	2,78 1 630 3/61,5	5,54 3 190 3/60,2	7,87 4 650 3/62	11,5 7 000 3/63,5	15,5 9 430 3/63,8	23,2 13 860 3/62,6	33,6 19 780 3/61,7	47,4 27 870 3/61,5	60,3 36 120 3/62,7	75,7 48 530 3/67,1	94,7 60 660 3/67,1	126 79 260 3/66	63	1000	
	56	-	-	-	-	-	-	8,16 4 800 3/55,4	13,1 7 710 3/55,5	15,2 8 920 3/55,3	26 14 920 3/54,1	35,9 21 130 3/55,5	48,9 28 860 3/55,6	69,3 41 230 3/56	75,7 46 360 3/57,8	94,6 57 950 3/57,8	128 80 920 3/59,4	56	900		
	50	-	0,66 385 3/49,4	0,75 465 3/51,5	1,34 800 3/49,8	1,58 940 3/49,8	2,78 1 700 3/51,2	5,84 3 450 3/49,5	7,75 4 670 3/50,4	11,5 7 000 3/50,8	15,5 9 430 3/51	22,2 13 960 3/52,6	32,2 19 930 3/51,8	45,5 28 070 3/51,7	57,9 36 390 3/52,7	76,7 48 420 3/52,9	95,9 60 520 3/52,9	127 79 080 3/52	50	800	
	45	-	-	-	-	-	-	8,16 4 950 3/45,1	12,9 7 730 3/44,4	17,7 10 530 3/44,2	24,6 15 060 3/45,4	34 21 330 3/46,6	46,4 29 130 3/46,7	65,8 41 620 3/47,1	75,7 46 350 3/45,5	94,7 57 940 3/45,5	138 86 750 3/46,8	45	710		
	40	-	0,62 385 3/40,8	0,62 400 3/42,5	1,01 670 3/43,6	1,18 775 3/43,6	2,76 1 640 3/39,1	5,21 3 220 3/40,8	8,19 4 800 3/38,7	13,3 7 750 3/38,5	16,1 9 750 3/39,9	24,6 15 500 3/41,5	34,4 21 060 3/40,4	48,1 30 950 3/42,4	67,2 41 930 3/41,2	86,2 53 250 3/40,7	108 66 560 3/40,7	127 81 180 3/42,3	40	630	
	35,5	-	-	-	-	-	-	7,79 4 990 3/37,5	12,5 7 750 3/36,5	17,1 10 590 3/36,3	25,5 14 970 3/34,4	35,2 21 210 3/35,4	46,3 29 140 3/36,9	65,7 41 640 3/37,2	73,2 46 640 3/37,4	91,5 58 300 3/37,4	131 86 020 3/38,4	35,5	560		
180 000	160	-	-	-	-	2,17 1 400 3/151	4,09 2 670 3/153	-	-	-	-	-	-	-	-	-	-	-	160	2240	14
	125	-	-	-	-	2,54 1 660 3/123	5 3 250 3/123	5,76 3 750 3/123	8,68 5 880 3/128	12,2 8 530 3/131	18,7 11 830 3/119	26,2 17 060 3/123	36,8 24 380 3/125	50,2 32 760 3/123	63,5 42 730 3/127	74,8 50 270 3/127	103 71 650 3/131	125	1800		
	100	-	-	-	-	2,43 1 700 3/103	5,03 3 450 3/101	6,97 4 760 3/100	9,85 7 200 3/107	13,2 9 700 3/108	20,7 14 140 3/100	30 20 180 3/98,5	42,3 28 440 3/98,5	53,8 36 860 3/100	69,1 49 330 3/105	86,3 61 670 3/105	115 80 580 3/103	100	1400		
	90	-	-	-	-	-	-	7,06 4 820 3/89,4	10,8 7 750 3/93,7	12,6 8 970 3/93,3	23,1 15 240 3/86,4	31,7 21 480 3/88,8	43,4 29 490 3/89	61,2 41 940 3/89,7	68,5 47 180 3/90,1	85,7 58 980 3/90,1	115 81 220 3/92,7	90	1250		
	80	-	0,48 310 3/75,2	0,55 365 3/78,2	0,82 580 3/82,7	0,95 670 3/82,7	2,18 1 400 3/75,5	4,16 2 670 3/75,3	6,87 4 770 3/81,4	9,85 7 200 3/85,7	13,2 9 700 3/86,1	19,9 14 240 3/84	28,8 20 330 3/82,7	40,6 28 650 3/82,7	51,7 37 130 3/84,3	70 49 220 3/82,5	87,5 61 530 3/82,5	116 80 390 3/81,1	80	1120	
	71	-	-	-	-	-	-	7,27 5 050 3/72,8	10,8 7 750 3/74,9	15,2 10 820 3/74,6	22,1 15 350 3/72,6	30,6 21 740 3/74,5	41,6 29 700 3/74,7	59 42 430 3/75,3	69,4 47 080 3/71	86,8 58 840 3/71	125 87 500 3/73	71	1000		
	63	-	0,61 385 3/60,1	0,61 405 3/62,6	0,95 670 3/66,3	1,11 785 3/66,3	2,55 1 660 3/61,5	5,07 3 240 3/60,2	7,19 4 730 3/62	10,6 7 110 3/63,5	14,2 9 580 3/63,8	21,2 14 080 3/62,6	30,7 20 100 3/61,7	43,4 28 320 3/61,5	55,1 36 700 3/62,7	69,3 49 310 3/67,1	86,6 61 640 3/67,1	115 80 540 3/66	63	900	
	56	-	-	-	-	-	-	7,28 4 810 3/55,4	11,7 7 750 3/55,5	13,6 8 950 3/55,3	23,5 15 190 3/54,1	32,4 21 470 3/55,5	44,2 29 380 3/55,6	62,6 41 910 3/56	68,5 47 190 3/57,8	85,6 58 990 3/57,8	115 81 220 3/59,4	56	800		

For n_1 lower than 560 min⁻¹ see page 107.

7 - Selection tables (helical gear reducers)

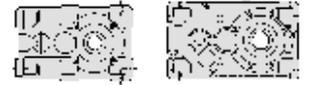

$n_{N2} \cdot L_h$ min ⁻¹ · h	i_N	P_{N2} kW																i_N	n_1 min ⁻¹	n_{N2} min ⁻¹		
		M_{N2} N m																				
		... / i																				
		50	63	64	80	81	100	125	140	160	180	200	225	250	280	320	321	360				
180 000	50	-	0,58 385 3i/49,4	0,68 470 3i/51,5	1,22 815 3i/49,8	1,43 960 3i/49,8	2,47 1 700 3i/51,2	5,18 3 450 3i/49,5	7 4 750 3i/50,4	10,4 7 120 3i/50,8	14 9 600 3i/51	20,1 14 210 3i/52,6	29,1 20 290 3i/51,8	41,1 28 580 3i/51,7	52,3 37 050 3i/52,7	69,3 49 300 3i/52,9	86,7 61 630 3i/52,9	115 80 520 3i/52	50	710	14	
	45	-	-	-	-	-	-	7,37 5 040 3i/45,1	11,5 7 750 3i/44,4	16 10 720 3i/44,2	22,3 15 330 3i/45,4	30,7 21 720 3i/46,6	41,9 29 670 3i/46,7	59,4 42 380 3i/47,1	68,4 47 200 3i/45,5	85,5 59 000 3i/45,5	123 87 500 3i/46,8	45	630			
	40	-	0,56 385 3i/40,8	0,56 410 3i/42,5	0,9 670 3i/43,6	1,06 790 3i/43,6	2,5 1 670 3i/39,1	4,71 3 280 3i/40,8	7,31 4 820 3i/38,7	11,8 7 750 3i/38,5	14,3 9 750 3i/39,9	21,9 15 500 3i/41,5	30,7 21 140 3i/40,4	43,5 31 500 3i/42,4	59,9 42 080 3i/41,2	78 54 210 3i/40,7	97,5 67 760 3i/40,7	117 84 100 3i/42,3	40	560		
160 000	160	-	-	-	-	1,96 1 420 3i/151	3,68 2 690 3i/153	-	-	-	-	-	-	-	-	-	-	-	160	2000	12,5	
	125	-	-	-	-	2,3 1 690 3i/123	4,52 3 310 3i/123	5,15 3 770 3i/123	7,82 5 950 3i/128	11 8 640 3i/131	16,7 11 890 3i/119	23,4 17 140 3i/123	32,9 24 550 3i/125	44,9 32 980 3i/123	57,2 43 250 3i/127	67,3 50 880 3i/127	93,1 72 520 3i/131	125	1600			
	100	-	-	-	-	2,17 1 700 3i/103	4,49 3 450 3i/101	6,33 4 840 3i/100	8,95 7 320 3i/107	12 9 870 3i/108	18,8 14 380 3i/100	27,3 20 530 3i/98,5	38,5 28 930 3i/98,5	48,9 37 500 3i/100	62,7 50 190 3i/105	78,4 62 730 3i/105	104 81 970 3i/103	100	1250			
	90	-	-	-	-	-	6,35 4 840 3i/89,4	9,7 7 750 3i/93,7	11,3 9 000 3i/93,3	21 15 490 3i/86,4	28,5 21 560 3i/88,8	39,5 29 980 3i/89	55 42 090 3i/89,7	62,4 47 980 3i/90,1	78 59 970 3i/90,1	103 81 500 3i/92,7	90	1120				
	80	-	0,43 310 3i/75,2	0,49 365 3i/78,2	0,73 580 3i/82,7	0,85 670 3i/82,7	1,96 1 420 3i/75,5	3,73 2 680 3i/75,3	6,24 4 850 3i/81,4	8,95 7 320 3i/85,7	12 9 870 3i/86,1	18,1 14 490 3i/84	26,2 20 680 3i/82,7	36,9 29 140 3i/82,7	46,9 37 770 3i/84,3	63,6 50 070 3i/82,5	79,4 62 590 3i/82,5	106 81 780 3i/81,1	80	1000		
	71	-	-	-	-	-	6,65 5 130 3i/72,8	9,75 7 750 3i/74,9	13,8 10 900 3i/74,6	20,1 15 500 3i/72,6	27,6 21 800 3i/74,5	38,1 30 180 3i/74,7	54 43 120 3i/75,3	63,5 47 830 3i/71	79,4 59 790 3i/71	113 87 500 3i/73	71	900				
	63	-	0,54 385 3i/60,1	0,55 410 3i/62,6	0,86 680 3i/66,3	1,01 800 3i/66,3	2,3 1 690 3i/61,5	4,59 3 300 3i/60,2	6,51 4 810 3i/62	9,55 7 240 3i/63,5	12,8 9 750 3i/63,8	19,2 14 330 3i/62,6	27,8 20 460 3i/61,7	39,2 28 830 3i/61,5	49,9 37 360 3i/62,7	62,7 50 200 3i/67,1	78,3 62 750 3i/67,1	104 81 980 3i/66	63	800		
	56	-	-	-	-	-	6,49 4 830 3i/55,4	10,4 7 750 3i/55,5	12,1 8 980 3i/55,3	21,2 15 460 3i/54,1	28,8 21 550 3i/55,5	40 29 910 3i/55,6	55,8 42 070 3i/56	61,9 48 050 3i/57,8	77,3 60 070 3i/57,8	102 81 530 3i/59,4	56	710				
	50	-	0,52 385 3i/49,4	0,61 480 3i/51,5	1,09 825 3i/49,8	1,28 965 3i/49,8	2,19 1 700 3i/51,2	4,6 3 450 3i/49,5	6,33 4 840 3i/50,4	9,42 7 250 3i/50,8	12,6 9 780 3i/51	18,2 14 470 3i/51,8	26,3 20 660 3i/51,7	37,2 29 110 3i/51,7	47,3 37 730 3i/52,7	62,6 50 200 3i/52,9	78,3 62 750 3i/52,9	104 81 990 3i/52	50	630		
	45	-	-	-	-	-	6,67 5 130 3i/45,1	10,2 7 750 3i/44,4	14,4 10 890 3i/44,2	20 15 500 3i/45,4	27,4 21 800 3i/46,6	37,9 30 200 3i/46,7	53,8 43 140 3i/47,1	61,9 48 050 3i/45,5	77,4 60 060 3i/45,5	110 87 500 3i/46,8	45	560				
140 000	160	-	-	-	-	1,79 1 440 3i/151	3,36 2 730 3i/153	-	-	-	-	-	-	-	-	-	-	-	160	1800	11,2	
	125	-	-	-	-	2,02 1 700 3i/123	4,04 3 370 3i/123	4,6 3 850 3i/123	6,98 6 070 3i/128	9,84 8 820 3i/131	14,9 12 130 3i/119	20,9 17 490 3i/123	29,4 25 050 3i/125	40,1 33 650 3i/123	51 44 130 3i/127	60 51 920 3i/127	82 73 000 3i/131	125	1400			
	100	-	-	-	-	1,94 1 700 3i/103	4,02 3 450 3i/101	5,77 4 920 3i/100	8,15 7 440 3i/107	10,9 10 030 3i/108	17,1 14 620 3i/100	24,8 20 880 3i/98,5	35 29 410 3i/98,5	44,6 38 120 3i/100	57,2 51 030 3i/105	71,4 63 780 3i/105	94,9 83 340 3i/103	100	1120			
	90	-	-	-	-	-	5,69 4 850 3i/89,4	8,66 7 750 3i/93,7	10,1 9 040 3i/93,3	18,8 15 500 3i/86,4	25,5 21 630 3i/88,8	35,9 30 500 3i/89	49,3 42 240 3i/89,7	56,7 48 800 3i/90,1	70,9 61 010 3i/90,1	92,4 81 790 3i/92,7	90	1000				
	80	-	0,4 315 3i/75,2	0,45 370 3i/78,2	0,66 580 3i/82,7	0,76 670 3i/82,7	1,8 1 440 3i/75,5	3,41 2 720 3i/75,3	5,7 4 930 3i/81,4	8,18 7 440 3i/85,7	11 10 030 3i/86,1	16,5 14 720 3i/84	23,9 21 010 3i/82,7	33,8 29 610 3i/82,7	42,9 38 380 3i/84,3	58,1 50 880 3i/82,5	72,6 63 590 3i/82,5	96,5 83 090 3i/81,1	80	900		

For n_1 lower than 560 min⁻¹ see page 107.

7 - Selection tables (helical gear reducers)



$n_{N2} \cdot L_h$ min ⁻¹ · h	i_N	P_{N2} kW																i_N	n_1	n_{N2} min ⁻¹	
		M_{N2} N m																			
		... / i																			
		50	63	64	80	81	100	125	140	160	180	200	225	250	280	320	321	360			
140 000	71	-	-	-	-	-	-	-	5,93 5 150 31/72,8	8,66 7 750 31/74,9	12,2 10 900 31/74,6	17,9 15 500 31/72,6	24,5 21 800 31/74,5	34,4 30 720 31/74,7	48,6 43 700 31/75,3	57,4 48 690 31/71	71,8 60 860 31/71	100 87 500 31/73	71	800	11,2
	63	-	0,48 385 31/60,1	0,5 420 31/62,6	0,77 690 31/66,3	0,91 810 31/66,3	2,06 1 700 31/61,5	4,15 3 360 31/60,2	5,88 4 900 31/62	8,63 7 370 31/63,5	11,6 9 930 31/63,8	17,3 14 600 31/62,6	25,1 20 840 31/61,7	35,5 29 350 31/61,5	45,1 38 040 31/62,7	56,6 51 110 31/61,1	70,8 63 890 31/61,1	94 83 480 31/66	63	710	
	56	-	-	-	-	-	-	-	5,78 4 850 31/55,4	9,21 7 750 31/55,5	10,7 9 000 31/55,3	18,9 15 500 31/54,1	25,7 21 630 31/55,5	36,1 30 460 31/55,6	49,7 42 230 31/56	55,9 48 930 31/57,8	69,9 61 160 31/57,8	90,9 81 830 31/59,4	56	630	
	50	-	0,46 385 31/49,4	0,55 485 31/51,5	0,97 825 31/49,8	1,14 970 31/49,8	1,95 1 700 31/51,2	4,09 3 450 31/49,5	5,73 4 930 31/50,4	8,53 7 390 31/50,8	11,4 9 950 31/51	16,4 14 730 31/52,6	23,8 21 030 31/51,8	33,6 29 630 31/51,7	42,8 38 400 31/52,7	56,7 51 100 31/52,9	70,9 63 880 31/52,9	94,1 83 460 31/52	50	560	
125 000	160	-	-	-	-	-	1,62 1 460 31/151	3,04 2 780 31/153	-	-	-	-	-	-	-	-	-	-	160	1600	10
	125	-	-	-	-	-	1,8 1 700 31/123	3,67 3 430 31/123	4,18 3 910 31/123	6,34 6 180 31/128	8,94 8 970 31/131	13,6 12 340 31/119	19 17 790 31/123	26,7 25 480 31/125	36,4 34 240 31/123	46,4 44 900 31/127	54,5 52 820 31/127	73,2 73 000 31/131	125	1250	
	100	-	-	-	-	-	1,73 1 700 31/103	3,59 3 450 31/101	5,24 5 000 31/100	7,33 7 500 31/107	9,93 10 210 31/108	15,6 14 880 31/100	22,5 21 200 31/98,5	31,8 29 920 31/98,5	40,5 38 780 31/100	51,9 51 910 31/105	64,9 64 890 31/105	86,2 84 780 31/103	100	1000	
	90	-	-	-	-	-	-	-	5,13 4 870 31/89,4	7,8 7 750 31/93,7	9,16 9 070 31/93,3	16,9 15 500 31/86,4	23 21 710 31/88,8	32,8 30 990 31/89	44,5 42 380 31/89,7	51,9 49 590 31/90,1	64,8 61 990 31/90,1	83,4 82 060 31/92,7	90	900	
	80	-	0,36 325 31/75,2	0,41 380 31/78,2	0,59 580 31/82,7	0,69 675 31/82,7	1,63 1 460 31/75,5	3,09 2 770 31/75,3	5,14 5 000 31/81,4	7,33 7 500 31/85,7	9,93 10 210 31/86,1	14,9 14 990 31/84	21,5 21 200 31/82,7	30,5 30 140 31/82,7	38,8 39 070 31/84,3	52,6 51 790 31/82,5	65,7 64 740 31/82,5	87,3 84 590 31/81,1	80	800	
	71	-	-	-	-	-	-	-	5,26 5 150 31/72,8	7,69 7 750 31/74,9	10,9 10 900 31/74,6	15,9 15 500 31/72,6	21,8 21 800 31/74,5	31,1 31 280 31/74,7	43,2 43 700 31/75,3	51,9 49 580 31/71	64,9 61 970 31/71	89,1 87 500 31/73	71	710	
	63	-	0,42 385 31/60,1	0,45 425 31/62,6	0,7 705 31/66,3	0,82 825 31/66,3	1,82 1 700 31/61,5	3,75 3 420 31/60,2	5,31 4 990 31/62	7,79 7 500 31/63,5	10,5 10 110 31/63,8	15,7 14 860 31/62,6	22,7 21 200 31/61,7	32 29 890 31/61,5	40,7 38 740 31/62,7	51,2 52 040 31/61,1	63,9 65 000 31/61,1	85 85 000 31/66	63	630	
	56	-	-	-	-	-	-	-	5,16 4 870 31/55,4	8,19 7 750 31/55,5	9,55 9 000 31/55,3	16,8 15 500 31/54,1	22,9 21 710 31/55,5	32,7 31 010 31/55,6	44,3 42 380 31/56	50,6 49 810 31/57,8	63,2 62 260 31/57,8	81,1 82 140 31/59,4	56	560	
112 000	160	-	-	-	-	-	1,45 1 490 31/151	2,72 2 840 31/153	-	-	-	-	-	-	-	-	-	-	160	1400	9
	125	-	-	-	-	-	1,62 1 700 31/123	3,3 3 450 31/123	3,81 3 980 31/123	5,78 6 280 31/128	8,14 9 120 31/131	12,3 12 550 31/119	17,3 18 090 31/123	24,3 25 910 31/125	33,2 34 810 31/123	42,2 45 650 31/127	49,7 53 700 31/127	65,6 73 000 31/131	125	1120	
	100	-	-	-	-	-	1,56 1 700 31/103	3,23 3 450 31/101	4,71 5 000 31/100	6,6 7 500 31/107	9,08 10 370 31/108	14,2 15 120 31/100	20,3 21 200 31/98,5	29,1 30 400 31/98,5	37 39 410 31/100	47,5 52 740 31/105	58,5 65 000 31/105	77,8 85 000 31/103	100	900	
	90	-	-	-	-	-	-	-	4,58 4 890 31/89,4	6,93 7 750 31/93,7	8,17 9 100 31/93,3	15 15 500 31/86,4	20,6 21 790 31/88,8	29,7 31 500 31/89	39,7 42 530 31/89,7	46,9 50 480 31/90,1	58,7 63 100 31/90,1	74,4 82 370 31/92,7	90	800	
	80	-	0,32 330 31/75,2	0,37 385 31/78,2	0,53 585 31/82,7	0,62 690 31/82,7	1,47 1 490 31/75,5	2,79 2 820 31/75,3	4,57 5 000 31/81,4	6,51 7 500 31/85,7	8,97 10 390 31/86,1	13,5 15 260 31/84	19 21 200 31/82,7	27,6 30 690 31/82,7	35,1 39 780 31/84,3	47,5 52 730 31/82,5	58,6 65 000 31/82,5	77,9 85 000 31/81,1	80	710	
	71	-	-	-	-	-	-	-	4,67 5 150 31/72,8	6,82 7 750 31/74,9	9,64 10 900 31/74,6	14,1 15 500 31/72,6	19,3 21 800 31/74,5	27,8 31 500 31/74,7	38,3 43 700 31/75,3	46,9 50 480 31/71	58,6 63 100 31/71	79 87 500 31/73	71	630	

For n_1 lower than 560 min⁻¹ see page 107.

7 - Selection tables (helical gear reducers)



$n_{N2} \cdot L_h$ min ⁻¹ · h	i_N	P_{N2} kW																i_N	n_1 min ⁻¹	n_{N2} min ⁻¹		
		M_{N2} N m																				
		... / i																				
		50	63	64	80	81	100	125	140	160	180	200	225	250	280	320	321	360				
112 000	63	-	0,38 385 3/60,1	0,41 435 3/62,6	0,63 715 3/66,3	0,74 840 3/66,3	1,62 1 700 3/61,5	3,36 3 450 3/60,2	4,73 5 000 3/62	6,93 7 500 3/63,5	9,46 10 290 3/63,8	14,2 15 130 3/62,6	20,2 21 200 3/61,7	29 30 420 3/61,5	36,9 39 430 3/62,7	46,3 52 980 3/67,1	56,8 65 000 3/67,1	75,5 85 000 3/66	63	560	9	
		160	-	-	-	-	1,3 1 500 3/151	2,47 2 890 3/153	-	-	-	-	-	-	-	-	-	-	-	160	1250	8
100 000	125	-	-	-	-	-	1,44 1 700 3/123	2,95 3 450 3/123	3,46 4 050 3/123	5,25 6 390 3/128	7,37 9 250 3/131	11,2 12 760 3/119	15,7 18 400 3/123	22,1 26 350 3/125	30,1 35 410 3/123	38,2 46 200 3/127	45 54 500 3/127	58,5 73 000 3/131	125	1000		
		100	-	-	-	-	1,39 1 700 3/103	2,87 3 450 3/101	4,19 5 000 3/100	5,87 7 500 3/107	8,17 10 500 3/108	12,9 15 390 3/100	18 21 200 3/98,5	26,1 30 700 3/98,5	33,5 40 120 3/100	42,4 53 000 3/105	52 65 000 3/105	69,1 85 000 3/103	100	800		
	90	-	-	-	-	-	-	4,08 4 910 3/89,4	6,15 7 750 3/93,7	7,28 9 130 3/93,3	13,3 15 500 3/86,4	18,3 21 800 3/88,8	26,3 31 500 3/89	35,4 42 690 3/89,7	42,4 51 400 3/90,1	53 64 250 3/90,1	66,2 82 500 3/92,7	90	710			
	80	-	0,29 335 3/75,2	0,33 395 3/78,2	0,48 595 3/82,7	0,56 700 3/82,7	1,31 1 500 3/75,5	2,52 2 880 3/75,3	4,05 5 000 3/81,4	5,78 7 500 3/85,7	8,11 10 580 3/86,1	12,2 15 500 3/84	16,9 21 200 3/82,7	24,5 30 700 3/82,7	31,7 40 510 3/84,3	42,4 53 000 3/82,5	52 65 000 3/82,5	69,1 85 000 3/81,1	80	630		
	71	-	-	-	-	-	-	-	4,15 5 150 3/72,8	6,06 7 750 3/74,9	8,57 10 900 3/74,6	12,5 15 500 3/72,6	17,2 21 800 3/74,5	24,7 31 500 3/74,7	34 43 700 3/75,3	42,4 51 390 3/71	53,1 64 240 3/71	70,3 87 500 3/73	71	560		
90 000	125	-	-	-	-	-	1,3 1 700 3/123	2,65 3 450 3/123	3,16 4 110 3/123	4,8 6 490 3/128	6,63 9 250 3/131	10,3 12 970 3/119	14,2 18 500 3/123	20 26 500 3/125	27,6 35 980 3/123	34,3 46 200 3/127	40,5 54 500 3/127	52,7 73 000 3/131	125	900		
		100	-	-	-	-	1,23 1 700 3/103	2,55 3 450 3/101	3,72 5 000 3/100	5,21 7 500 3/107	7,28 10 540 3/108	11,5 15 500 3/100	16 21 200 3/98,5	23,2 30 700 3/98,5	30,3 40 850 3/100	37,6 53 000 3/105	46,2 65 000 3/105	61,4 85 000 3/103	100	710		
	90	-	-	-	-	-	-	3,63 4 920 3/89,4	5,46 7 750 3/93,7	6,48 9 170 3/93,3	11,8 15 500 3/86,4	16,2 21 800 3/88,8	23,3 31 500 3/89	31,5 42 860 3/89,7	38,3 52 340 3/90,1	47,9 65 420 3/90,1	58,7 82 500 3/92,7	90	630			
	80	-	0,26 335 3/75,2	0,3 400 3/78,2	0,43 610 3/82,7	0,51 715 3/82,7	1,17 1 500 3/75,5	2,28 2 930 3/75,3	3,6 5 000 3/81,4	5,13 7 500 3/85,7	7,22 10 600 3/86,1	10,8 15 500 3/84	15 21 200 3/82,7	21,8 30 700 3/82,7	28,7 41 230 3/84,3	37,7 53 000 3/82,5	46,2 65 000 3/82,5	61,4 85 000 3/81,1	80	560		
	160	-	-	-	-	-	1,04 1 500 3/151	2,04 2 990 3/153	-	-	-	-	-	-	-	-	-	-	-	160	1120	7,1
80 000	125	-	-	-	-	-	1,15 1 700 3/123	2,36 3 450 3/123	2,86 4 190 3/123	4,27 6 500 3/128	5,9 9 250 3/131	9,28 13 200 3/119	12,6 18 500 3/123	17,8 26 500 3/125	24,8 36 500 3/123	30,5 46 200 3/127	36 54 500 3/127	46,8 73 000 3/131	125	800		
		100	-	-	-	-	1,09 1 700 3/103	2,26 3 450 3/101	3,3 5 000 3/100	4,62 7 500 3/107	6,48 10 580 3/108	10,2 15 500 3/100	14,2 21 200 3/98,5	20,6 30 700 3/98,5	27,3 41 590 3/100	33,4 53 000 3/105	41 65 000 3/105	54,4 85 000 3/103	100	630		
	90	-	-	-	-	-	-	3,24 4 940 3/89,4	4,85 7 750 3/93,7	5,78 9 200 3/93,3	10,5 15 500 3/86,4	14,4 21 800 3/88,8	20,8 31 500 3/89	28,1 43 020 3/89,7	34,7 53 280 3/90,1	43,3 66 600 3/90,1	52,2 82 500 3/92,7	90	560			
	160	-	-	-	-	0,93 1 500 3/151	1,85 3 000 3/153	-	-	-	-	-	-	-	-	-	-	-	-	160	900	5,6
	125	-	-	-	-	1,02 1 700 3/123	2,09 3 450 3/123	2,58 4 260 3/123	3,79 6 500 3/128	5,23 9 250 3/131	8,24 13 200 3/119	11,2 18 500 3/123	15,8 26 500 3/125	22 36 500 3/123	27,1 46 200 3/127	32 54 500 3/127	41,6 73 000 3/131		125	710		

For n_1 lower than 560 min⁻¹ see page 107.

7 - Selection tables (helical gear reducers)



$n_{N2} \cdot L_h$ min ⁻¹ · h	i_N	P_{N2} kW M_{N2} N m ... / i																i_N	n_1 min ⁻¹	n_{N2} min ⁻¹	
		50	63	64	80	81	100	125	140	160	180	200	225	250	280	320	321				360
71 000	100	-	-	-	-	-	0,97 1 700 3/103	2,01 3 450 3/101	2,93 5 000 3/100	4,11 7 500 3/107	5,78 10 600 3/108	9,08 15 500 3/100	12,6 21 200 3/98,5	18,3 30 700 3/98,5	24,7 42 340 3/100	29,7 53 000 3/105	36,4 65 000 3/105	48,4 85 000 3/103	100	560	5,6
63 000	160	-	-	-	-	-	0,83 1 500 3/151	1,64 3 000 3/153	-	-	-	-	-	-	-	-	-	-	160	800	5
	125	-	-	-	-	-	0,91 1 700 3/123	1,86 3 450 3/123	2,34 4 340 3/123	3,36 6 500 3/128	4,64 9 250 3/131	7,31 13 200 3/119	9,94 18 500 3/123	14 26 500 3/125	19,6 36 500 3/123	24 46 200 3/127	28,4 54 500 3/127	36,9 73 000 3/131	125	630	
56 000	160	-	-	-	-	-	0,74 1 500 3/151	1,46 3 000 3/153	-	-	-	-	-	-	-	-	-	-	160	710	4,5
	125	-	-	-	-	-	0,81 1 700 3/123	1,65 3 450 3/123	2,09 4 370 3/123	2,99 6 500 3/128	4,13 9 250 3/131	6,5 13 200 3/119	8,84 18 500 3/123	12,4 26 500 3/125	17,4 36 500 3/123	21,4 46 200 3/127	25,2 54 500 3/127	32,8 73 000 3/131	125	560	
50 000	160	-	-	-	-	-	0,65 1 500 3/151	1,29 3 000 3/153	-	-	-	-	-	-	-	-	-	-	160	630	4
45 000	160	-	-	-	-	-	0,58 1 500 3/151	1,15 3 000 3/153	-	-	-	-	-	-	-	-	-	-	160	560	3,55

For n_1 lower than 560 min⁻¹ see page 107.

7 - Selection tables (helical gear reducers)



Summary of transmission ratios i , torques M_{N2} [N m] valid for $n_1 \leq 90 \text{ min}^{-1}$

i_N	i																	
	M_{N2} [N m]																	
	50	63	64	80	81	100	125	140	160	180	200	225	250	280	320	321	360	
R I	2	-	-	-	-	-	2 ¹⁾ 2 500	-	1,95 3 870	-	2,05 8 250	-	2 ¹⁾ 17 500	-	1,95 30 000	1,95 35 500	-	
	2,24	-	-	-	-	-	2,28 2 900	2,3 ¹⁾ 3 650	2,21 4 370	2,24 5 450	2,2 ¹⁾ 9 000	2,27 11 500	2,33 20 600	2,3 ¹⁾ 25 000	2,26 34 500	2,26 41 200	2,29 46 200	
	2,5	-	2,53 387	-	2,44 750	-	2,55 1 320	2,53 3 250	2,44 4 000	2,5 ¹⁾ 4 750	2,55 6 150	2,43 10 300	2,53 12 200	2,53 22 400	2,44 27 200	2,44 37 500	2,5 ¹⁾ 45 000	2,5 ¹⁾ 51 500
	2,8	-	-	-	-	-	-	2,75 ¹⁾ 3 450	2,82 4 500	2,81 5 450	2,83 6 900	2,82 11 500	2,83 14 500	2,81 25 000	2,82 30 700	2,81 43 700	2,81 51 500	2,83 58 000
	3,15	-	3,28 387	-	3,13 825	-	3,27 1 450	3,28 3 450	3,13 5 000	3,13 6 150	3,25 ¹⁾ 8 000	3,27 13 200	3,18 16 000	3,28 27 200	3,19 34 500	3,13 48 700	3,13 56 000	3,25 ¹⁾ 67 000
	3,55	-	-	-	-	-	-	3,62 3 250	3,64 4 620	3,62 6 700	3,6 ¹⁾ 8 250	3,57 14 000	3,67 16 500	3,62 28 000	3,64 35 500	3,5 ¹⁾ 43 700	3,5 ¹⁾ 56 000	3,6 ¹⁾ 65 000
	4	-	4 ¹⁾ 345	-	4,16 750	-	3,92 1 400	4 ¹⁾ 3 000	4,08 4 370	4,13 6 700	4,15 9 000	4,13 13 200	4,07 18 500	4 ¹⁾ 26 500	4,08 35 500	4,07 47 500	4,07 56 000	4 ¹⁾ 73 000
	4,5	-	-	-	-	-	-	4,45 2 720	4,5 ¹⁾ 3 650	4,5 ¹⁾ 6 300	4,67 8 000	4,5 ¹⁾ 12 500	4,67 15 500	4,47 24 300	4,5 ¹⁾ 30 000	4,5 ¹⁾ 41 200	4,5 ¹⁾ 51 500	4,6 ¹⁾ 63 000
	5	-	5 ¹⁾ 325	-	5,2 ¹⁾ 630	-	4,82 1 320	5 ¹⁾ 2 720	5 ¹⁾ 3 450	4,92 5 800	5,07 7 300	4,92 11 800	5,07 14 000	5,08 24 300	5 ¹⁾ 28 000	4,92 40 000	4,92 50 000	5,07 58 000
R 2 I	6,3	6,42 150	6,53 345	6,86 ¹⁾ 412	6,41 650	6,41 825	6,42 1 550	6,53 2 500	-	6,41 5 300	-	6,42 11 500	-	6,53 23 000	-	6,41 40 000	6,41 48 700	-
	8	8,01 206	8,26 387	7,99 487	8,03 825	8,03 975	8,01 1 700	8,26 3 450	-	8,03 6 300	-	8,01 15 500	-	8,26 31 500	-	8,03 54 500	8,03 69 000	-
	9	-	-	-	-	-	-	-	9,22 4 000	9,24 6 300	9,31 7 750	8,85 15 500	8,88 19 000	9,19 31 500	9,22 41 200	9,24 54 500	9,24 69 000	9,31 87 500
	10	10,2 206	10,7 387	11,2 ¹⁾ 487	10,3 825	10,3 975	10,2 1 700	10,7 3 450	10,2 4 370	10,3 7 750	10,7 10 000	10,2 15 500	9,95 21 200	10,7 31 500	10,4 43 700	10,3 54 500	10,3 69 000	10,7 87 500
	11,2	-	-	-	-	-	-	-	11,9 ¹⁾ 5 150	11,9 7 750	11,8 10 900	11,2 15 500	11,5 21 800	11,8 31 500	11,9 ¹⁾ 43 700	11,5 ¹⁾ 51 500	11,5 ¹⁾ 65 000	11,8 87 500
	12,5	12,3 200	13,1 387	13,6 450	13,7 750	13,7 875	12,3 1 700	13,1 3 450	13,3 5 000	13,6 7 500	13,6 10 600	13 15 500	12,8 21 200	13,1 30 700	13,3 41 200	13,4 53 000	13,4 65 000	13,1 85 000
	14	-	-	-	-	-	-	-	14,7 ¹⁾ 4 870	14,1 7 750	14,4 ¹⁾ 10 900	13,9 15 500	14,6 20 000	14,6 28 000	14,7 ¹⁾ 40 000	14,3 54 500	14,3 69 000	14,4 ¹⁾ 87 500
	16	16,3 200	15,8 387	16,5 487	15,7 800	15,7 975	16,1 1 700	15,8 3 450	15,1 4 500	15,7 7 750	16,6 10 600	16,1 15 500	15,6 20 000	16,2 31 500	15,7 40 000	15,9 54 500	15,9 69 000	16 ¹⁾ 85 000
	18	-	-	-	-	-	-	-	17,6 5 150	18,1 7 750	18 ¹⁾ 10 000	17,6 15 500	18,1 21 800	17,8 31 500	17,9 43 700	17,8 54 500	17,8 69 000	18,3 87 500
	20	20,1 175	19,3 387	20,1 475	20,8 800	20,8 925	19,3 1 700	19,3 3 450	19,6 5 000	20,7 7 500	20,8 10 600	20,3 15 500	20 21 200	19,7 30 700	20,1 42 500	20,6 53 000	20,6 65 000	20,3 85 000
	22,4	-	-	-	-	-	-	-	21,7 4 750	22,5 7 100	23,3 10 000	22,2 14 500	23 20 000	22 29 000	22,2 40 000	22,8 50 000	22,8 60 000	23,4 80 000
	25	24,4 155	24,1 335	25,1 412	26 ¹⁾ 670	26 ¹⁾ 800	23,7 1 500	24,1 3 000	24,1 4 370	24,6 6 500	25,4 9 250	24,2 13 200	25 18 500	25 26 500	24,6 36 500	25 46 200	25 54 500	25,7 73 000
	28	-	-	-	-	-	-	-	-	-	-	-	-	-	-	-	-	-
R 3 I	28	-	-	-	-	-	-	29,1 4 750	28,4 6 300	28,6 7 750	27,2 15 500	27,3 21 200	28,7 31 500	28,8 43 700	30 54 500	30 69 000	30,3 87 500	
	31,5	-	33,5 365	34,9 412	32,8 825	32,8 925	32,6 1 550	33,5 3 250	32,2 5 150	31,6 7 750	32,8 10 900	31,5 15 500	30,6 21 800	33,5 31 500	32,5 43 700	33,5 54 500	34,7 69 000	34,7 87 500
	35,5	-	-	-	-	-	-	-	37,5 5 150	36,5 7 750	36,3 10 900	34,4 15 500	35,4 21 800	36,9 31 500	37,2 43 700	37,4 54 500	38,4 69 000	38,4 87 500
	40	-	40,8 387	42,5 475	43,6 825	43,6 950	39,1 1 700	40,8 3 450	38,7 5 150	38,5 7 750	39,9 10 900	41,5 15 500	40,4 21 800	42,4 31 500	41,2 43 700	40,7 54 500	40,7 69 000	42,3 87 500
	45	-	-	-	-	-	-	-	45,1 5 150	44,4 7 750	44,2 10 900	45,4 15 500	46,6 21 800	46,7 31 500	47,1 43 700	45,5 54 500	45,5 69 000	46,8 ¹⁾ 87 500
	50	-	49,4 387	51,5 487	49,8 825	49,8 975	51,2 1 700	49,5 3 450	50,4 5 000	50,8 7 500	51 10 600	52,6 15 500	51,8 21 200	51,7 30 700	52,7 42 500	52,9 53 000	52,9 65 000	52 ¹⁾ 85 000
	56	-	-	-	-	-	-	-	55,4 5 150	55,5 7 750	55,3 10 600	54,1 15 500	55,5 21 800	55,6 31 500	56 43 700	57,8 54 500	57,8 69 000	59,4 ¹⁾ 87 500
	63	-	60,1 387	62,6 475	66,3 825	66,3 950	61,5 1 700	60,2 3 450	62 5 000	63,5 7 500	63,8 10 600	62,6 15 500	61,7 21 200	61,5 30 700	62,7 42 500	67,1 ¹⁾ 53 000	67,1 ¹⁾ 65 000	66 ¹⁾ 85 000
	71	-	-	-	-	-	-	-	72,8 5 150	74,9 7 750	74,6 10 900	72,6 15 500	74,5 21 800	74,7 31 500	75,3 43 700	71 ¹⁾ 54 500	71 ¹⁾ 69 000	73 87 500
	80	-	75,2 335	78,2 412	82,7 710	82,7 825	75,5 1 500	75,3 3 000	81,4 5 000	85,7 7 500	86,1 10 600	84 15 500	82,7 21 200	82,7 30 700	84,3 42 500	82,5 53 000	82,5 65 000	81,1 85 000
	90	-	-	-	-	-	-	-	89,4 5 150	93,7 7 750	93,3 10 600	86,4 15 500	88,8 21 800	89 31 500	89,7 43 700	90,1 54 500	90,1 69 000	92,7 87 500
	100	-	-	-	-	-	103 1 700	101 3 450	100 5 000	107 7 500	108 10 600	100 15 500	98,5 21 200	98,5 30 700	100 42 500	105 53 000	105 65 000	103 85 000
	125	-	-	-	-	-	123 1 700	123 3 450	123 4 370	128 6 500	131 9 250	119 13 200	123 18 500	125 26 500	123 36 500	127 46 200	127 54 500	131 73 000
160	-	-	-	-	-	151 1 500	153 3 000	-	-	-	-	-	-	-	-	-	-	

1) Finite transmission ratio.

This page is intentionally left blank.

8 – Dimensions, designs, mounting positions (helical gear reducers)

8.1 - Gear reducers R 1	110
Dimensions	110
Designs (direction of rotation)	111
Mounting positions.....	112
Lubrication details	113
8.2 - Gear reducers R 2I	114
Dimensions	114
Designs (direction of rotation)	115
Mounting positions.....	116
Lubrication details	117
8.3 - Gear reducers R 3I	118
Dimensions	118
Designs (direction of rotation)	119
Mounting positions.....	120
Lubrication details	121
8.4 - Gear reducers R 2I – Long model	122
Dimensions	122
Designs (direction of rotation)	123
Mounting positions.....	124
Lubrication details	125
8.5 - Gear reducers R 3I – Long model	126
Dimensions	126
Designs (direction of rotation)	126
Mounting positions.....	127
Lubrication details	128

8 - Dimensions, designs, mounting positions (helical gear reducers)

8.1 - Gear reducers R I

Dimensions

R I 63 ... 100

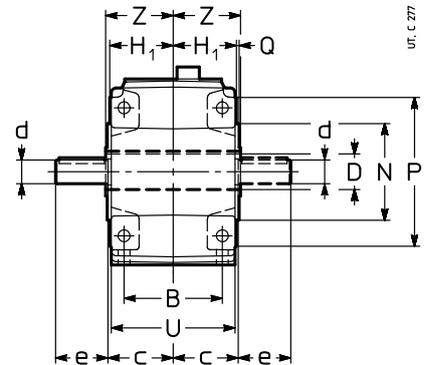
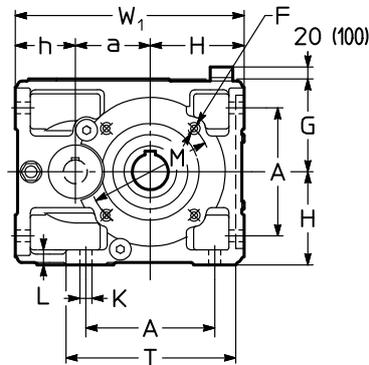

R I 125 ... 360

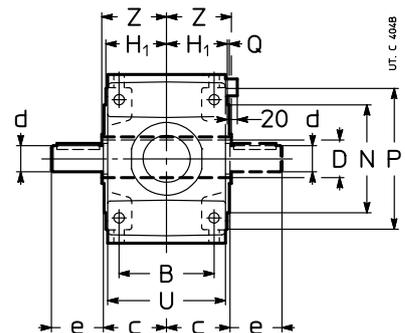
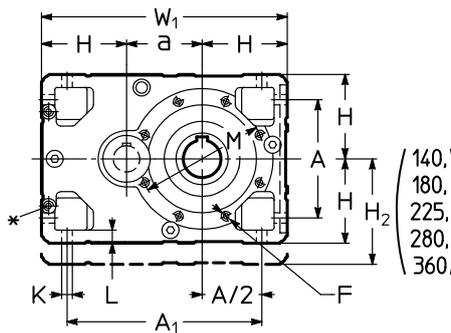

Size	a	A	A ₁	B	c	D	d	e	d	e	F	H	H ₁	H ₂	h	K	L	M	N	P	Q	T	U	W ₁	Z	kg	
						Ø H7	Ø		Ø		1)	h11		h11	h11	Ø		Ø	Ø h6	Ø							
							$i_N \leq 3,55$ $i_N \leq 4^{3)}$		$i_N \geq 4$ $i_N \geq 4,5^{3)}$			G															
63	63	102	-	90	61	30	24	50	19	40	M8	80	58,5	-	62	11,5	14	100	80	120	3	143	114	205	63	12	
80	80	132	-	106	72	38	28	60	24	50	M10	100	69,5	-	70	14	17	130	110	160	3,5	180	135	250	75	23	
100	100	172	-	131	87	48	32	80	28	60	M12	125	84,5	-	80	16	20	165	130	200	3,5	228	165	305	90	43	
125	125	212	337	162	107	60	48	110	38	80	2)	150	103,5	-	18	23	215	180	250	4	-	201	425	110	84		
140	140	212	352	162	107	70	48	110	38	80	2)	150	103,5	180	-	18	23	265	230	300	4	-	201	440	125	97	
160	160	252	412	201	132	80	55	110	48	110	M16	180	128,5	-	22	28	265	230	300	4	-	249	520	136	148		
180	180	252	432	201	132	90	55	110	48	110	M16	180	128,5	225	-	22	28	300	250	350	5	-	249	540	150	171	
200	200	320	520	250	162	100	70	140	60	140	2)	225	158	-	27	34	350	300	400	5	-	307	650	167	262		
225	225	320	545	250	162	110	70	140	60	140	M20	225	158	280	-	27	34	400	350	450	5	-	307	675	180	303	
250	250	396	646	310	204	125	90	170	75	140	2)	280	195	-	33	42	500	450	550	5	-	380	810	206	467		
280	280	396	676	310	204	140	90	170	75	140	M24	280	195	355	-	33	42	500	450	550	5	-	380	840	222	540	
320, 321	320	510	830	386	256	160	110	210	95	170	2)	355	241	-	39	52	600	550	660	6	-	470	1030	254	832		
360	360	510	870	386	256	180	110	210	95	170	M30	355	241	450	-	39	52	600	550	660	6	-	470	1070	273	963	

* Machined surface and N. 2 threaded holes (dimensions in ch. 6 «Gear reducer input face») on opposite side (not in view) too.

1) Working length of thread 2 · F.

2) For dimension, number and angular position, see ch. 8.

3) Valid for sizes 140, 180, 225, 280 and 360.



8 - Dimensions, designs, mounting positions (helical gear reducers)

Designs (direction of rotation)

R I 63 ... 100

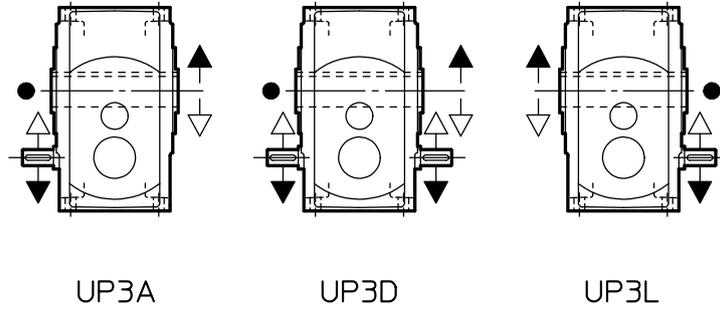

UT. C 297

R I 125 ... 360

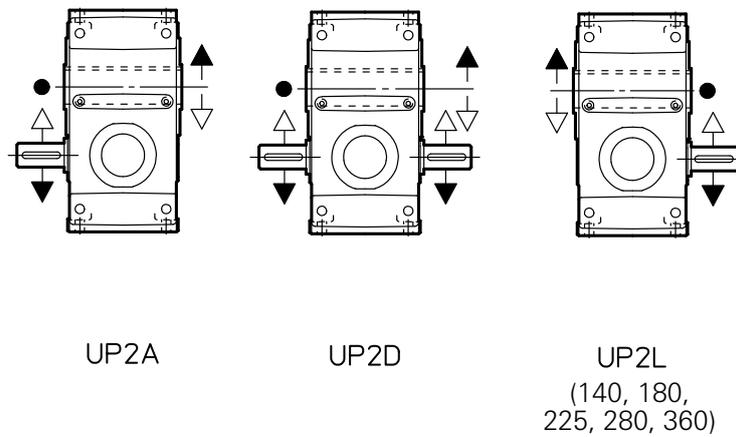

UT. C 407B

● Position of reference groove (see ch. 16) for radial load verification.

8 - Dimensions, designs, mounting positions (helical gear reducers)

Mounting positions R I 63 ... 360

Unless otherwise stated, gear reducers are supplied in mounting position **B3** (see ch. 2).

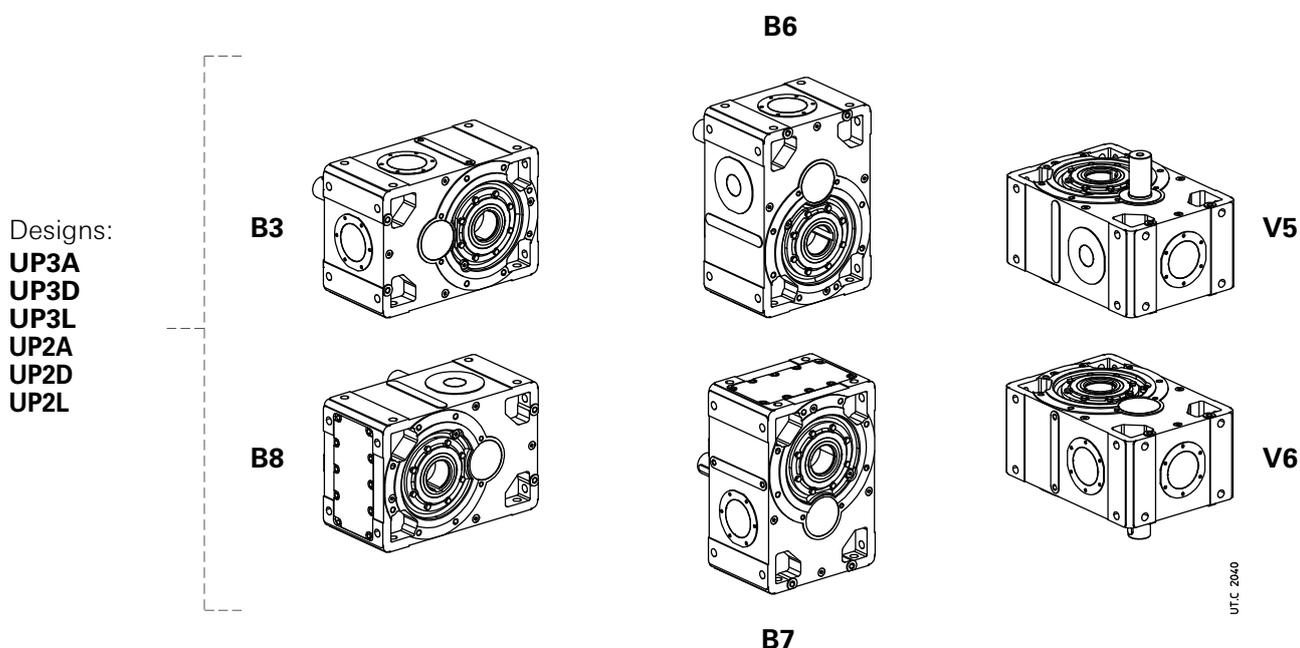

Oil quantity R I 63 ... 360

Stated oil quantities [l] are approximate for provisioning. The exact oil quantity the gear reducer is to be filled with is defined by the level plug.

Mounting position	63	80	100	125	140	160	180	200	225	250	280	320, 321	360
B3	0,7	1,2	2,1	5,3	8,2	10,5	16,1	20,5	31,5	40	61	78	120
B8	0,7	1,2	2,1	5,3	5,5	10,5	10,7	20,5	21	40	41	78	80
B6	1	1,9	3,6	7	8,7	13,7	17	26,7	33,3	52	65	102	127
B7	0,8	1,5	2,6	7,6	9,7	15	19	29	37	57	72	111	141
V5	1	1,9	3,6	8,9	10,3	17,5	20,1	34	39,3	67	77	130	150
V6	0,5	0,95	1,8	4,7	4,9	9,3	9,5	18	18,6	35	36	67	71

8 - Dimensions, designs, mounting positions (helical gear reducers)

Lubrication details

R I 100

Designs:
UP3A
UP3D
UP3L

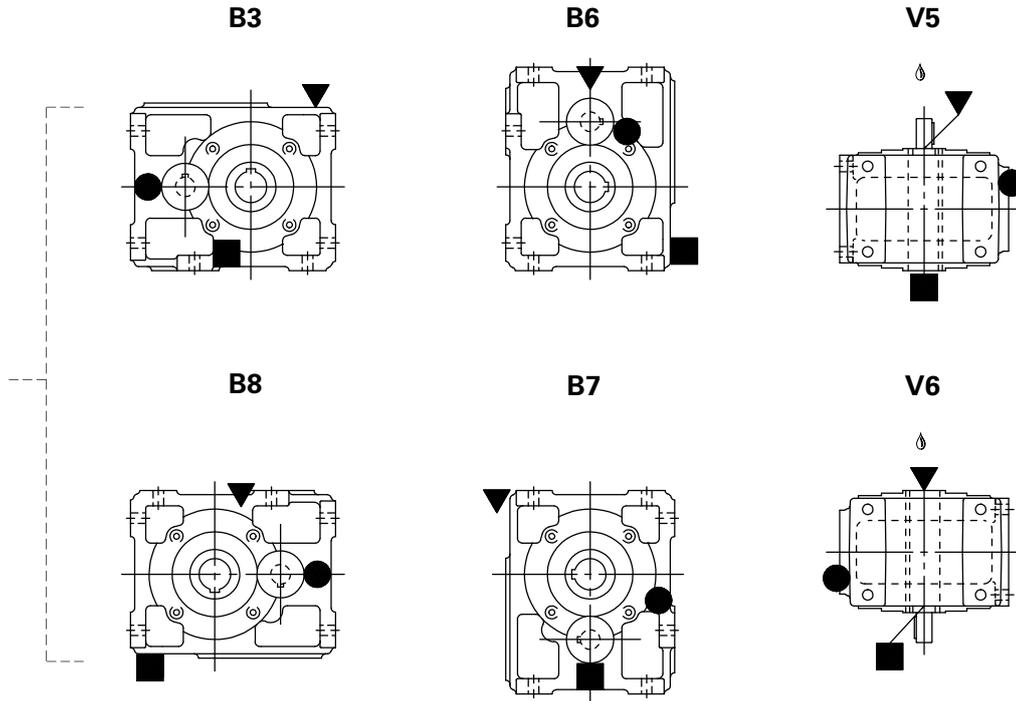

U.T.C. 1042

R I 125 ... 360

Designs:
UP2A
UP2D
UP2L

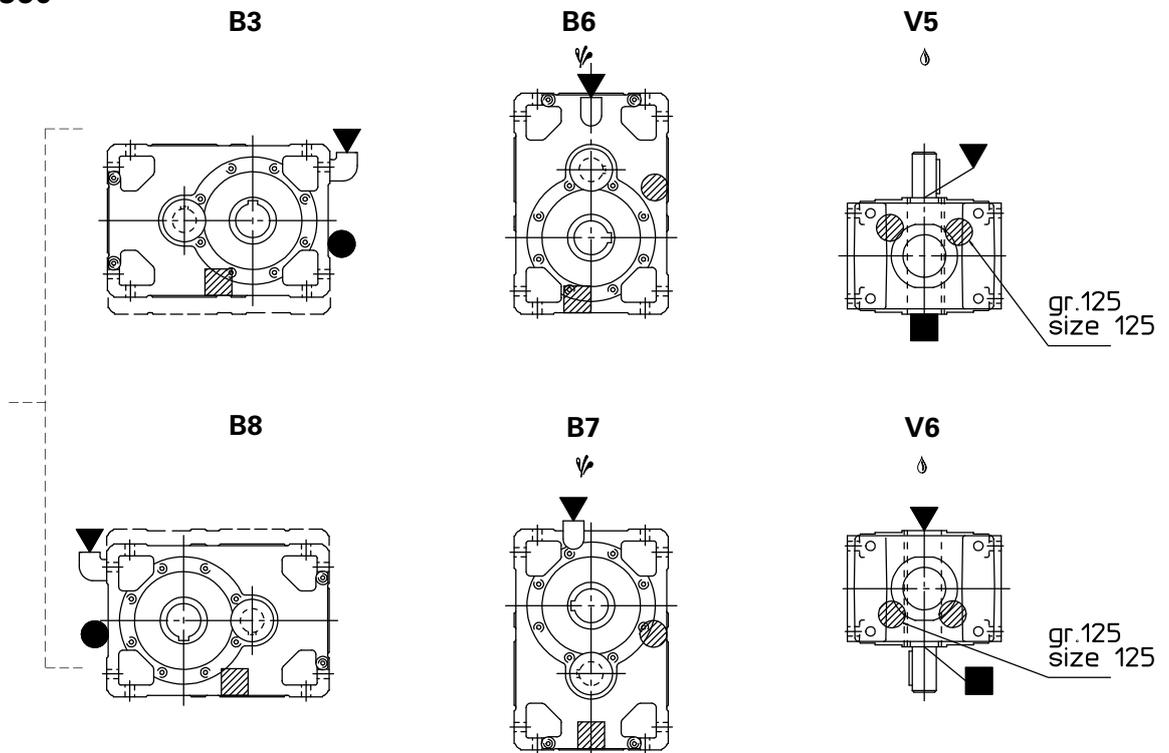

U.T.C. 1043

♣ Possible high oil splash: for the corrective factor f_{t_3} of nominal thermal power P_{tN} see ch. 4.
 ♠ Possible bearing lubrication pump or lubrication device on high speed shaft (see ch. 17 (19)).

▼ oil filler plug
 ● oil level plug
 ■ oil drain plug
 ○ oil level plug on opposite side (not in view)
 ▨ oil drain plug on opposite side (not in view)

8 - Dimensions, designs, mounting positions (helical gear reducers)

8.2 - Gear reducers R 2I

Dimensions

R 2I 50 ... 125

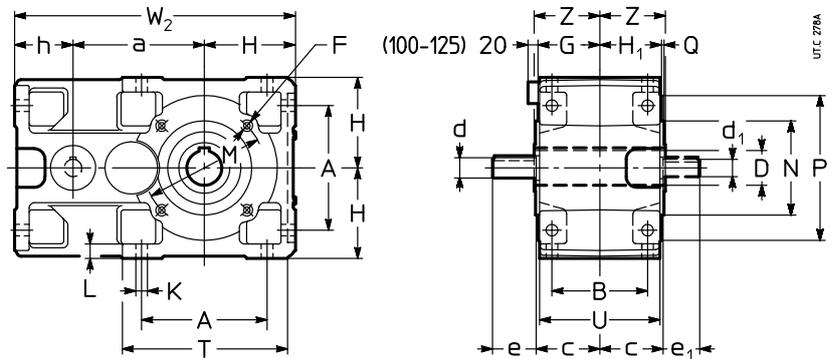
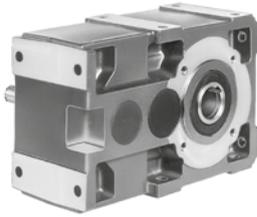

Size	a	A	B	c	D Ø H7	d Ø <i>i_N ≤ 12,5</i>	e Ø <i>i_N ≥ 16</i>	d ₁ Ø	e ₁	d ₁ Ø	e ₁	F 1)	H h11	H ₁ G	h h11	K Ø	L	M Ø	N Ø h6	P Ø	Q	T	U	W ₂	Z	kg
50	90	86	75	51	24	16	30	14	30	14	30	M6	67	49	50	9,5	12	85	70	105	2,5	120	95	207	53	9
63	113	102	90	61	30	19	40	16	30	16	30	M8	80	58,5	62	11,5	14	100	80	120	3	143	114	255	63	14
64	115	102	90	61	32	19	40	16	30	16	30	M8	80	58,5	62	11,5	14	100	80	120	3	143	114	257	63	14
80	142,5	132	106	72	38	24	50	19	40	19	40	M10	100	69,5	70	14	17	130	110	160	3,5	180	135	313	75	26
81	142,5	132	106	72	40	24	50	19	40	19	40	M10	100	69,5	70	14	17	130	110	160	3,5	180	135	313	75	26
100	180	172	131	87	48	28	60	24	50	24	50	M12	125	84,5	80	16	20	165	130	200	3,5	228	165	385	90	47
125	225	212	162	107	60	32	80	32	80	28	60	2)	150	103,5	100	18	23	215	180	250	4	274	201	475	110	84

R 2I 140 ... 360

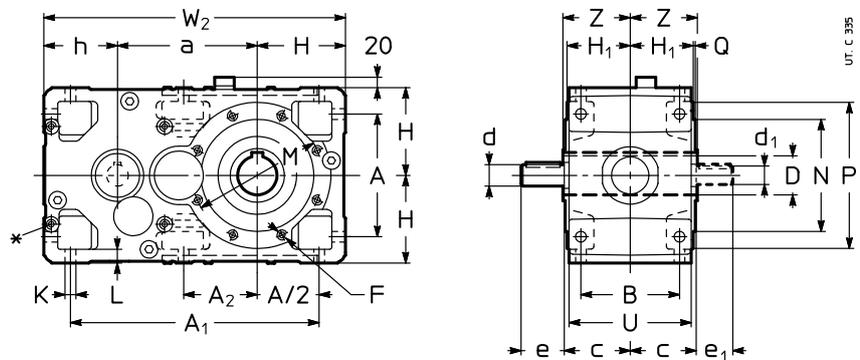
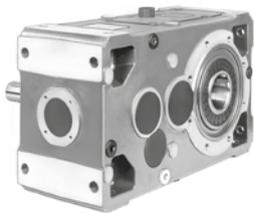

Size	a	A	A ₁	A ₂	B	c	D Ø H7	d Ø	e Ø	d ₁ Ø	e ₁	F 1)	H h11	H ₁ h11	h h11	K Ø	L	M Ø	N Ø h6	P Ø	Q	U	W ₂	Z	kg
140	240	212	427	127	162	107	70	32	80	28	60	2)	150	103,5	125	18	23	265	230	300	4	201	515	125	108
160	285	252	507	-	201	132	80	42	110	38	80	M16	180	128,5	150	22	28	265	230	300	4	249	615	136	176
180	305	252	527	170	201	132	90	42	110	38	80	M16	180	128,5	150	22	28	300	250	350	5	249	635	150	194
200	360	320	635	-	250	162	100	55	110	48	110	2)	225	158	180	27	34	350	300	400	5	307	765	167	309
225	385	320	660	223	250	162	110	55	110	48	110	M20	225	158	180	27	34	400	350	450	5	307	790	180	340
250	450	396	791	-	310	200	125	70	140	55	110	2)	280	195	225	33	42	500	450	550	5	380	955	206	543
280	480	396	821	277	310	200	140	70	140	55	110	M24	280	195	225	33	42	500	450	550	5	380	985	222	597
320, 321	570	510	1005	-	386	245	160	90	170	70	140	2)	355	241	280	39	52	600	550	660	6	470	1205	254	1150
360	610	510	1045	358	386	245	180	90	170	70	140	M30	355	241	280	39	52	600	550	660	6	470	1245	273	1300

* Machined surface and N.4 threaded holes (dimensions in ch. 6 «Gear reducer input face») on opposite side (not in view) too.

1) Working length of thread 2 · F.

2) For dimension, number and angular position see ch. 6.



8 - Dimensions, designs, mounting positions (helical gear reducers)

Designs (direction of rotation)

R 2I 50 ... 125

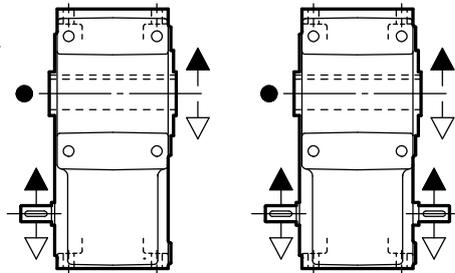

UT. C. 298

UP2A

UP2D

8

R 2I 140 ... 360

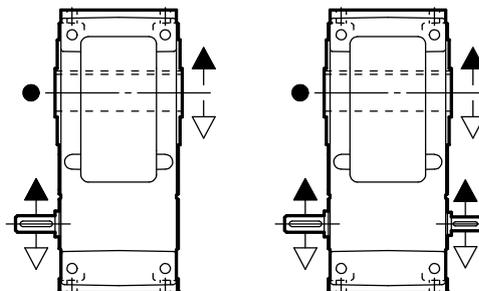

UP2A

UP2D

● Position of the reference groove (see ch. 16) for the verification of the radial load.

8 - Dimensions, designs, mounting positions (helical gear reducers)

Mounting positions

Unless otherwise stated, gear reducers are supplied in mounting position **B3** (see ch. 2).

R 2I 50 ... 125

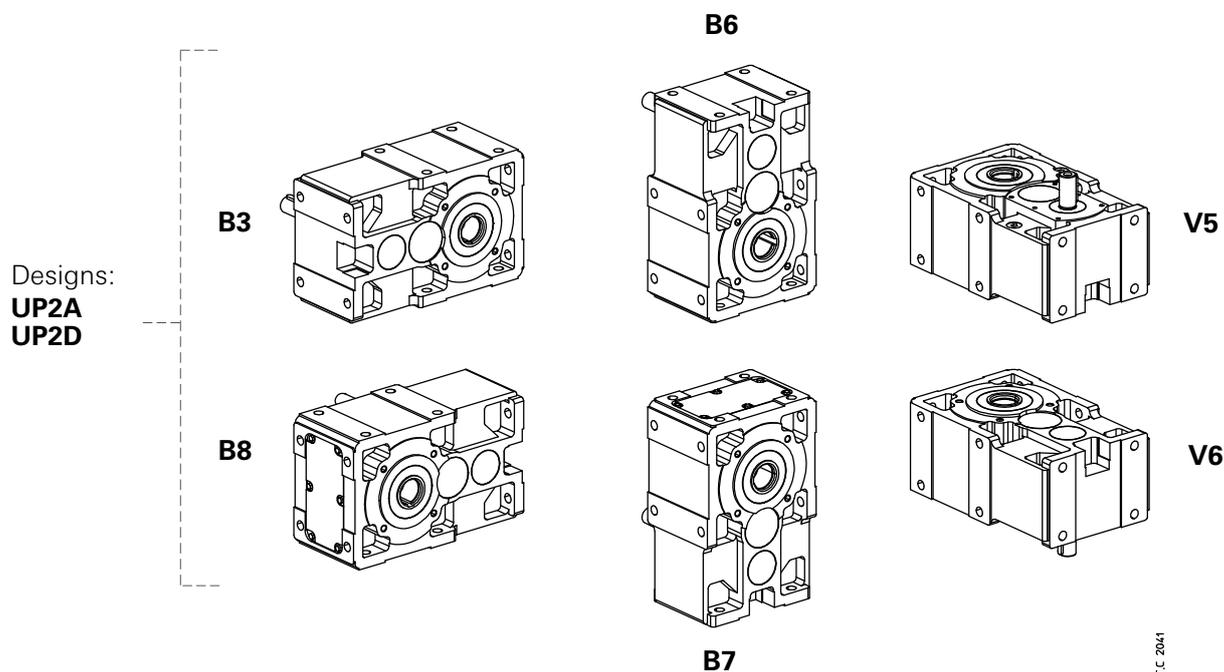

8 R 2I 140 ... 360

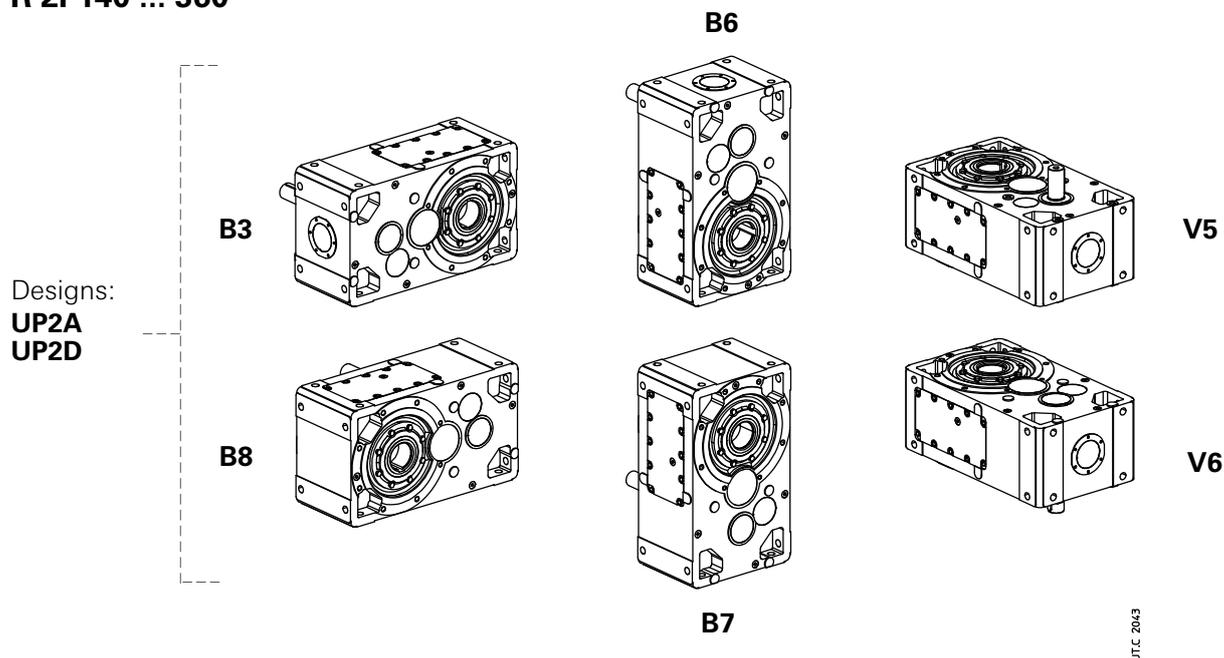

Oil quantity R 2I 50 ... 360

Stated oil quantities [l] are approximate for provisioning. The exact oil quantity the gear reducer is to be filled with is defined by the level plug.

Mounting position	50	63, 64	80, 81	100	125	140	160	180	200	225	250	280	320, 321	360
B3	0,6	0,9	1,5	3,2	5,8	6,6	12	13	25	26	47	51	97	100
B8	0,6	0,9	1,5	3,2	5,8	6,6	12	13	25	26	47	51	97	100
B6	0,9	1,4	2,7	5,4	10,5	10,8	20	21	39	41	75	80	152	156
B7	0,8	1,2	2,3	5	9	9,7	18	19	35	37	67	72	137	140
V5	0,8	1,2	2,3	5	9	9,7	18	19	35	37	67	72	137	140
V6	0,8	1,2	2,3	5	9	9,7	18	19	35	37	67	72	137	140

8 - Dimensions, designs, mounting positions (helical gear reducers)

Lubrication details

R 2I 100, 125

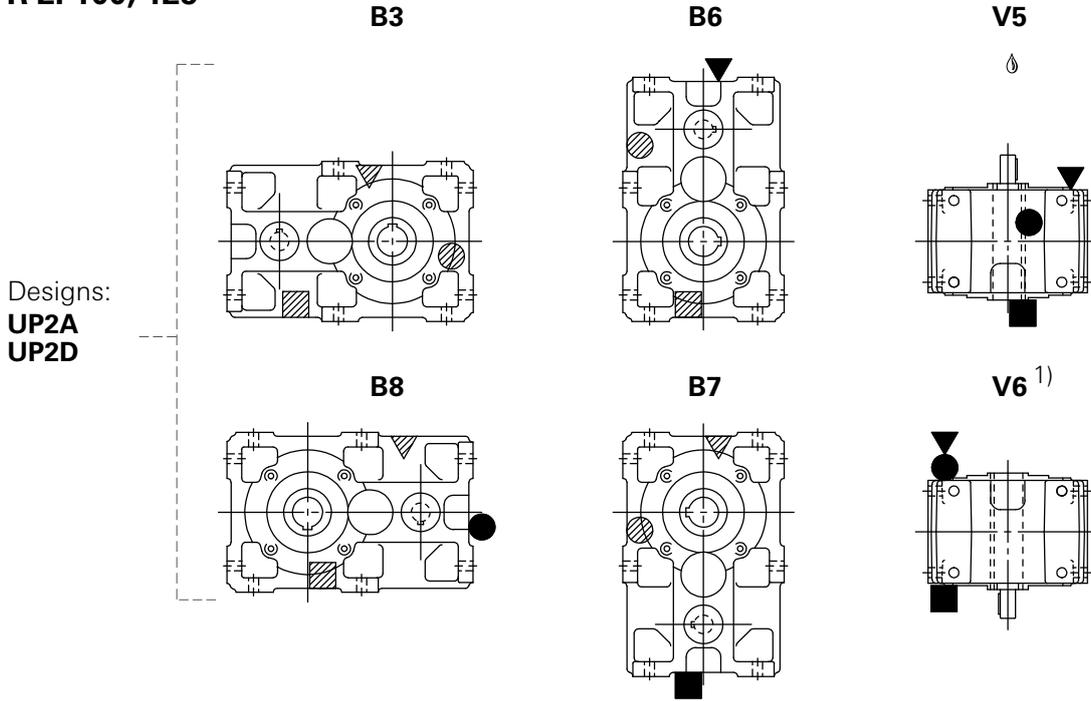

R 2I 140 ... 360

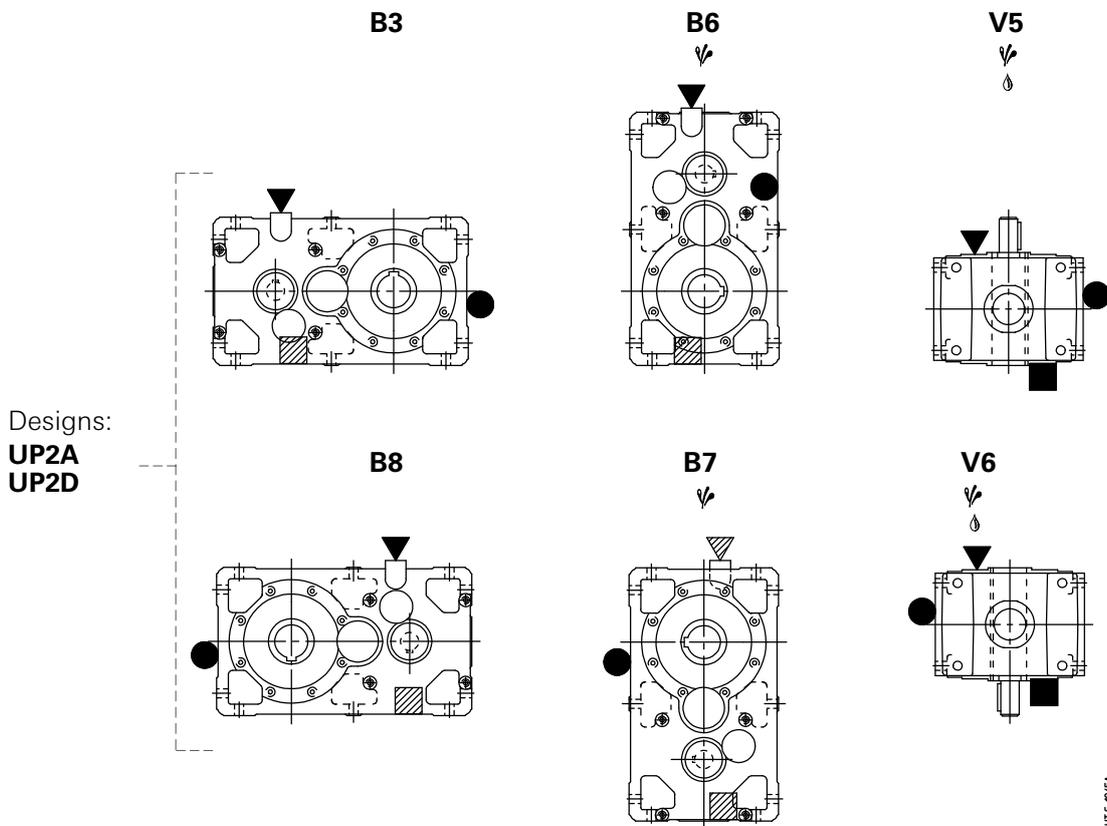

▽ Possible high oil splash: for the corrective factor ft_3 of nominal thermal power P_{tN} see ch. 4.

♯ Possible bearing lubrication pump or lubrication device on high speed shaft (see ch. 17 (19)).

1) See also ch. 6 page 43.

- ▼ oil filler plug
- oil level plug
- oil drain plug
- ▼ oil filler plug with oil level dip stick

- ▽ oil filler plug on opposite side (not in view)
- oil level plug on opposite side (not in view)
- oil drain plug on opposite side (not in view)

8 - Dimensions, designs, mounting positions (helical gear reducers)

8.3 - Gear reducers R 3I

Dimensions

R 3I 63 ... 125

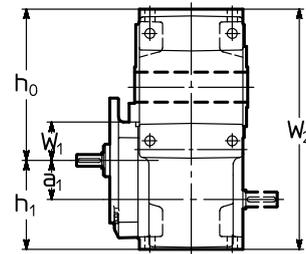
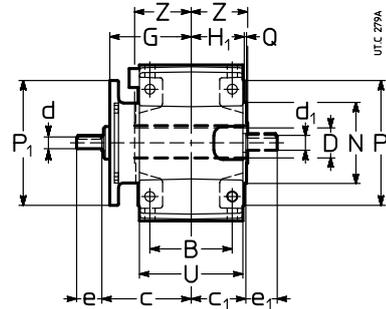
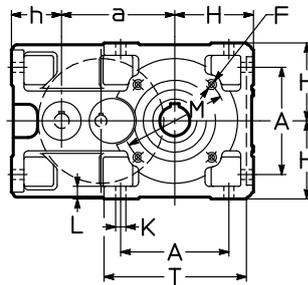
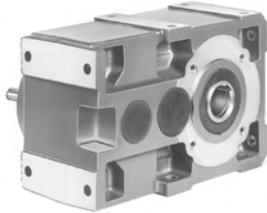

Size	a	a ₁	A	B	c	c ₁	D ∅ H7	d ∅	e	d		e ₁	F	G	H	H ₁	h	h ₀	h ₁	K ∅	L	M ∅	N ∅ h6	P ∅	P ₁ ∅	Q	T	U	W ₁	W ₂	Z	kg	
										∅	i _N ≤ 80																						i _N ≥ 100
63	113	40	102	90	99	61	30	11	23	-	-	16	30	M8	90	80	58,5	62	153	102	11,5	14	100	80	120	140 ³⁾	3	143	114	40	255	63	17
64	115	40	102	90	99	61	32	11	23	-	-	16	30	M8	90	80	58,5	62	155	102	11,5	14	100	80	120	140 ³⁾	3	143	114	40	257	63	17
80	142,5	50	132	106	117	72	38	14	30	-	-	19	40	M10	108	100	69,5	70	192,5	120	14	17	130	110	160	160 ³⁾	3,5	180	135	50	313	75	29
81	142,5	50	132	106	117	72	40	14	30	-	-	19	40	M10	108	100	69,5	70	192,5	120	14	17	130	110	160	160 ³⁾	3,5	180	135	50	313	75	29
100	180	62,5	172	131	141	87	48	19	40	16	30	24	50	M12	130	125	88,5	80	242	143	16	20	165	130	200	200	3,5	228	165	62	385	90	52
125	225	80	212	162	170	107	60	24	50	19	40	28	60	2)	159	150	103,5	100	295	180	18	23	215	180	250	200	4	274	201	86	475	110	92

R 3I 140 ... 360

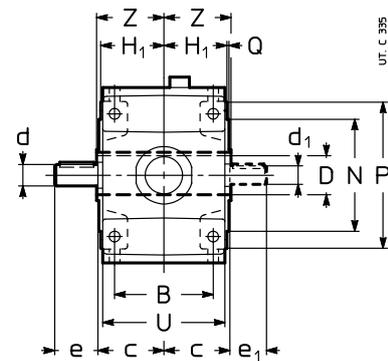
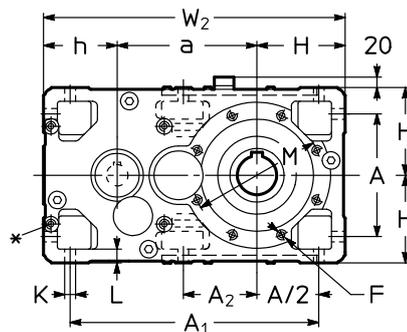

Size	a	A	A ₁	A ₂	B	c	D ∅ H7	d ∅	e	d		e ₁	F	H	H ₁	h	K ∅	L	M ∅	N ∅ h6	P ∅	Q	U	W ₂	Z	kg	
										∅	i _N ≤ 63																i _N ≥ 71
140	240	212	427	127	162	107	70	28	60	24	50	24	50	2)	150	103,5	125	18	23	265	230	300	4	201	515	125	108
160	285	252	507	-	201	132	80	32	80	28	60	28	60	M16	180	128,5	150	22	28	265	230	300	4	249	615	136	176
180	305	252	527	170	201	132	90	32	80	28	60	28	60	M16	180	128,5	150	22	28	300	250	350	5	249	635	150	194
200	360	320	635	-	250	162	100	42	110	38	80	38	80	2)	225	158	180	27	34	350	300	400	5	307	765	167	309
225	385	320	660	223	250	162	110	42	110	38	80	38	80	M20	225	158	180	27	34	400	350	450	5	307	790	180	340
250	450	396	791	-	310	200	125	55	110	48	110	45	110	2)	280	195	225	33	42	500	450	550	5	380	955	206	543
280	480	396	821	277	310	200	140	55	110	48	110	45	110	M24	280	195	225	33	42	500	450	550	5	380	985	222	597
320, 321	570	510	1005	-	386	245	160	70	140	55	110	55	110	2)	355	241	280	39	52	600	550	660	6	470	1205	254	1150
360	610	510	1045	358	386	245	180	70	140	55	110	55	110	M30	355	241	280	39	52	600	550	660	6	470	1245	273	1300

* Machined surface and N.4 threaded holes (dimensions in ch. 6 «Gear reducer input face») on opposite side (not in view) too.

1) Working length of thread 2 · F.

2) For dimension, number and angular position see ch. 6.

3) Square flange: for dimensions see ch. 6.



8 - Dimensions, designs, mounting positions (helical gear reducers)

Designs (direction of rotation)

R 3I 63 ... 125

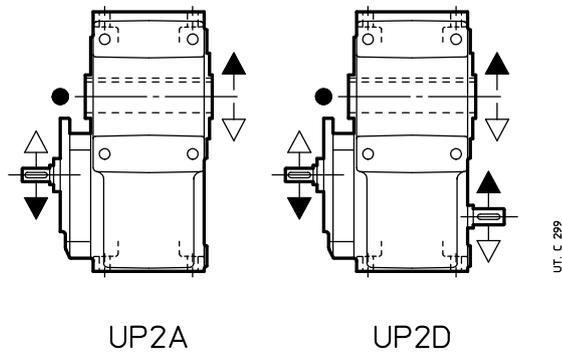

8

R 3I 140 ... 360

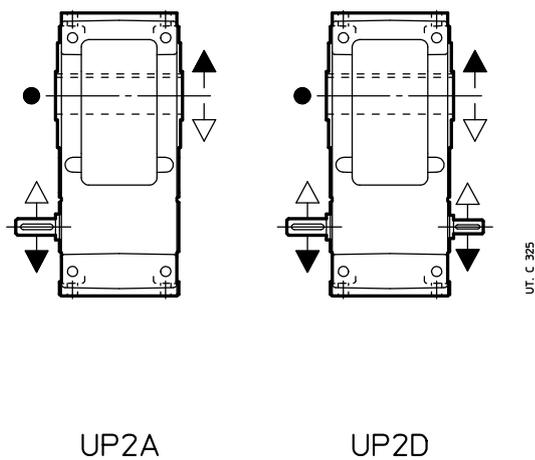

● Position of the reference groove (see ch. 16) for radial load verification.

8 - Dimensions, designs, mounting positions (helical gear reducers)

Mounting positions

Unless otherwise stated, gear reducers are supplied in mounting position **B3** (see ch. 2).

R 3I 63 ... 125

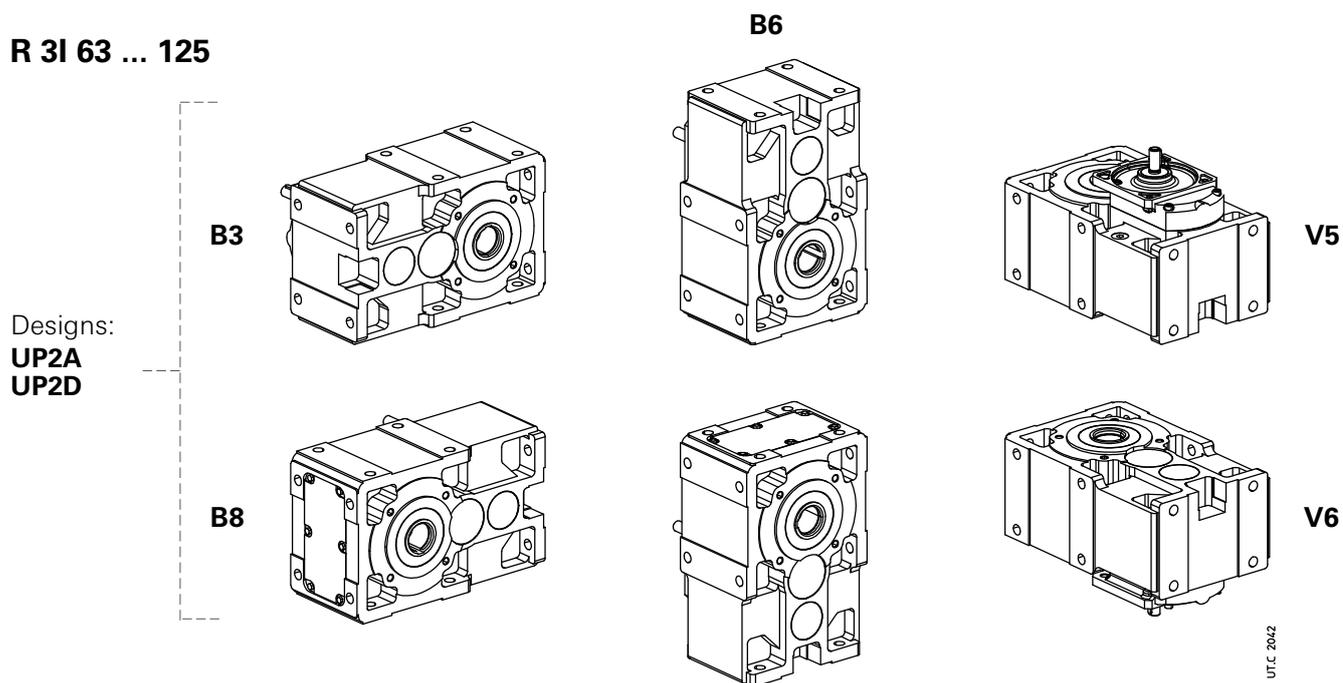

8 R 3I 140 ... 360

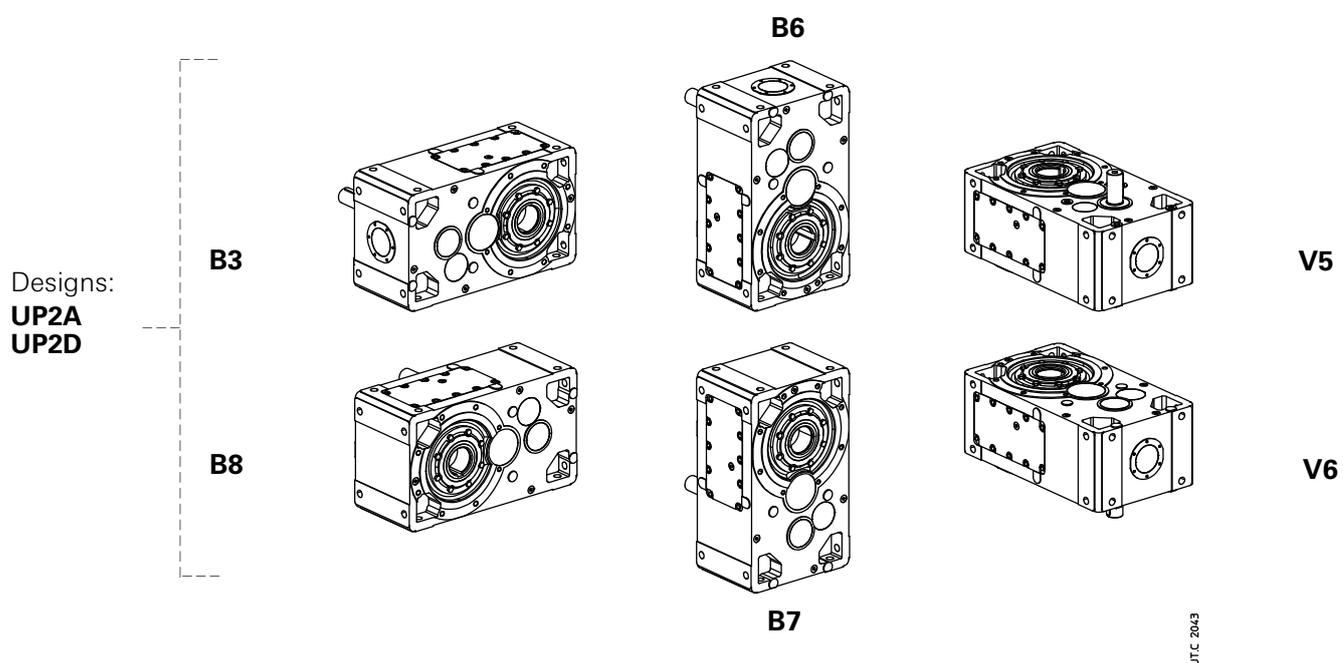

Oil quantity R 3I 63 ... 360

Stated oil quantities [l] are approximate for provisioning. The exact oil quantity the gear reducer is to be filled with is defined by the level plug.

Mounting position	63, 64	80, 81	100	125	140	160	180	200	225	250	280	320, 321	360
B3	1	1,7	3,3	6,1	6,6	12	13	25	26	47	51	97	100
B8	1	1,7	3,3	6,1	9,7	18	19	35	37	67	72	137	140
B6	1,5	2,9	5,7	10,2	9,7	18	19	35	37	67	72	137	140
B7	1,3	2,5	4,9	8,8	9,7	18	19	35	37	67	72	137	140
V5	1,3	2,5	4,9	8,8	9,7	18	19	35	37	67	72	137	140
V6	1,3	2,5	4,9	8,8	9,7	18	19	35	37	67	72	137	140

8 - Dimensions, designs, mounting positions (helical gear reducers)

Lubrication details

R 3I 100, 125

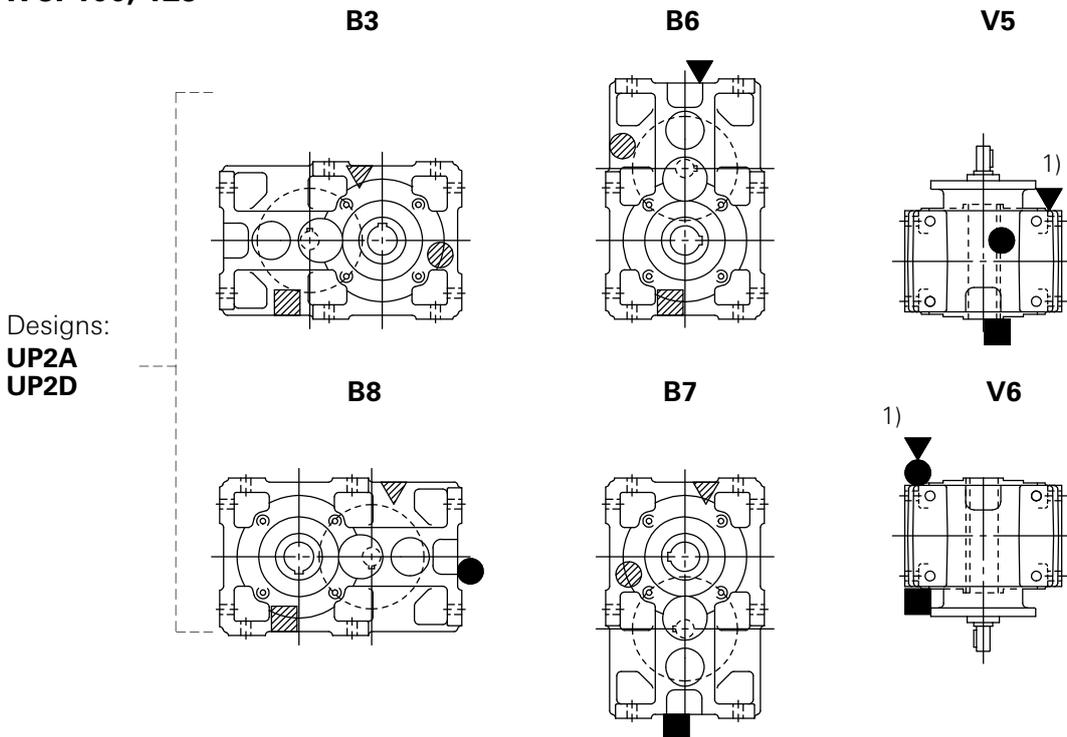

R 3I 140 ... 360

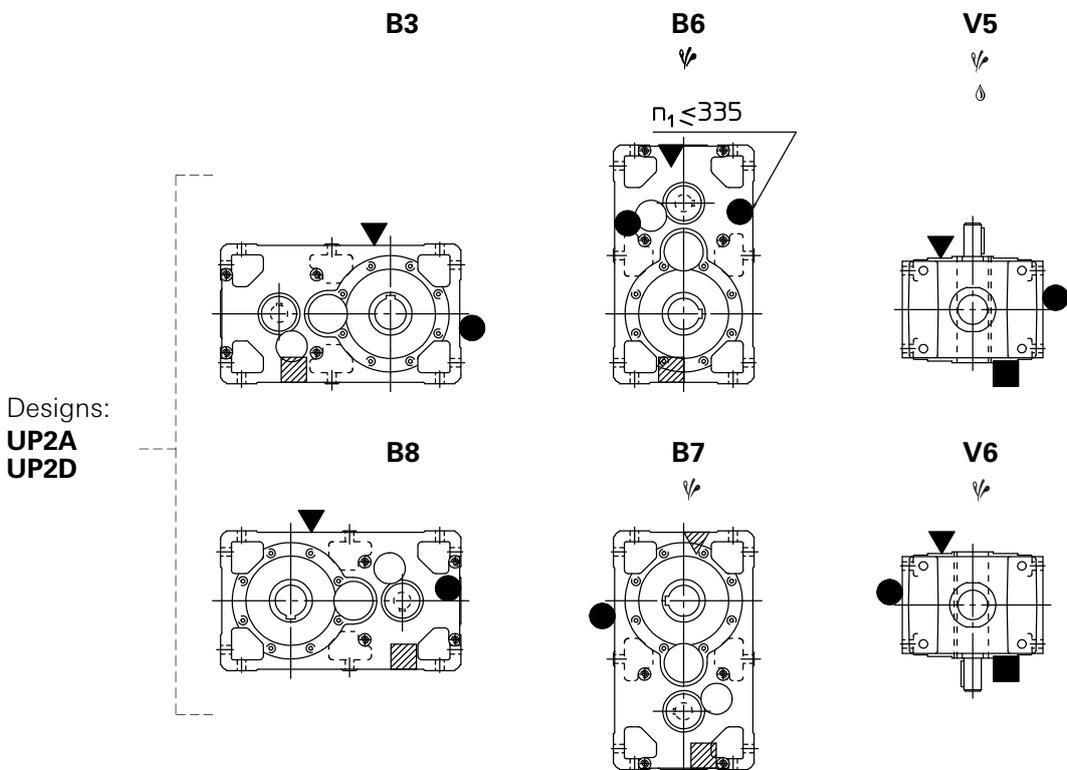

▽ Possible high oil splash: for the corrective factor f_{t_3} of nominal thermal power P_{t_N} see ch. 4.

⚡ Possible bearing lubrication pump or lubrication device on high speed shaft (see ch. 17 (19)).

1) See also ch. 6 page. 43.

▽ oil filler plug
● oil level plug
■ oil drain plug
● oil filler plug with oil level dip stick

▽ oil filler plug on opposite side (not in view)
● oil level plug on opposite side (not in view)
■ oil drain plug on opposite side (not in view)

8 - Dimensions, designs, mounting positions (helical gear reducers)

8.4 - Gear reducers R 2I – Long model

Dimensions

R 2I 100, 125 – Long model

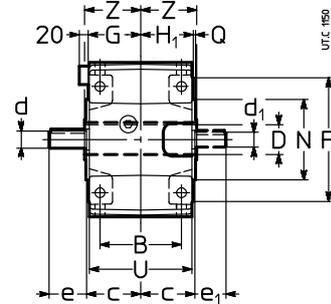
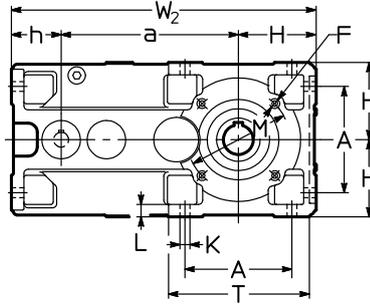
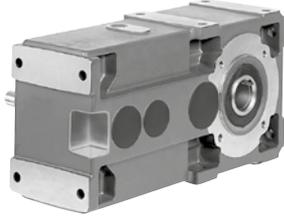

Size	a	A	B	c	D Ø H7	d Ø	e	d Ø	e	d ₁ Ø	e ₁	F 1)	H h11	H ₁ G	h h11	K Ø	L	M Ø	N Ø h6	P Ø	Q	T	U	W ₂	Z	kg
100	284,7	172	131	87	48	28	60	24	50	24	50	M12	125	84,5	80,3	16	20	165	130	200	3,5	228	165	490	90	56
125	358	212	162	107	60	32	80	32	80	28	60	2)	150	103,5	100	18	23	215	180	250	4	274	201	608	110	100

8

R 2I 140 ... 360 – Long model

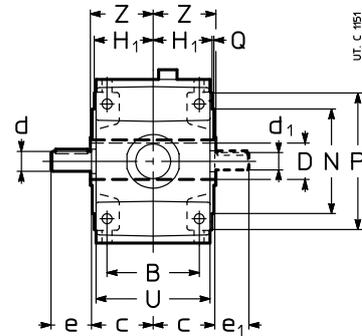
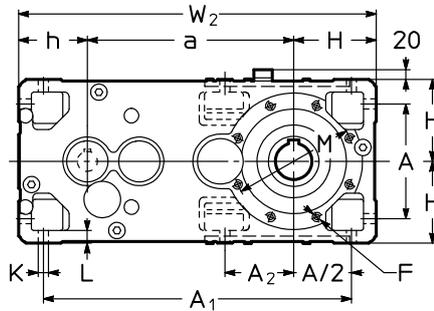
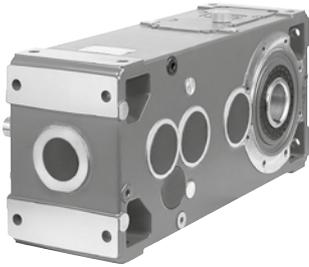

Size	a	A	A ₁	A ₂	B	c	D Ø H7	d Ø	e	d ₁ Ø	e ₁	F 1)	H h11	H ₁	h h11	K Ø	L	M Ø	N Ø h6	P Ø	Q	U	W ₂	Z	kg
140	373	212	560	127	162	107	70	32	80	28	60	2)	150	103,5	125	18	23	265	230	300	4	201	648	125	124
160	450	252	672	-	201	132	80	42	110	38	80	M16	180	128,5	150	22	28	265	230	300	4	249	780	136	204
180	470	252	692	170	201	132	90	42	110	38	80	M16	180	128,5	150	22	28	300	250	350	5	249	800	150	222
200	556	320	831	-	250	162	100	55	110	48	110	2)	225	158	180	27	34	350	300	400	5	307	961	167	357
225	581	320	856	223	250	162	110	55	110	48	110	M20	225	158	180	27	34	400	350	450	5	307	986	180	389
250	690	396	1031	-	310	200	125	70	140	55	110	2)	280	195	225	33	42	500	450	550	5	380	1195	206	625
280	720	396	1061	277	310	200	140	70	140	55	110	M24	280	195	225	33	42	500	450	550	5	380	1225	222	682
320, 321	870	510	1305	-	386	245	160	90	170	70	140	2)	355	241	280	39	52	600	550	660	6	470	1505	254	1290
360	910	510	1345	358	386	245	180	90	170	70	140	M30	355	241	280	39	52	600	550	660	6	470	1545	273	1445

1) Working length of thread 2 · F.

2) For dimension, number and angular position see ch. 6.



8 - Dimensions, designs, mounting positions (helical gear reducers)

Designs (direction of rotation)

R 2l 100, 125 – Long model

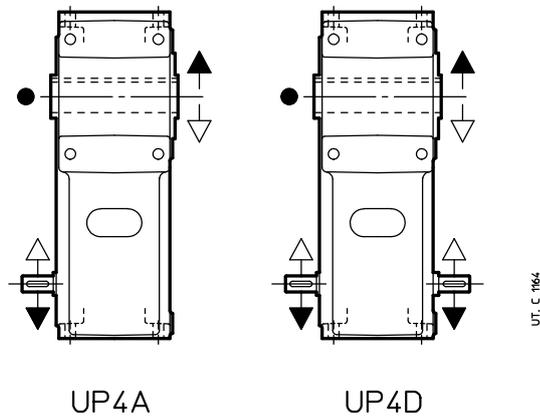

8

R 2l 140 ... 360 – Long model

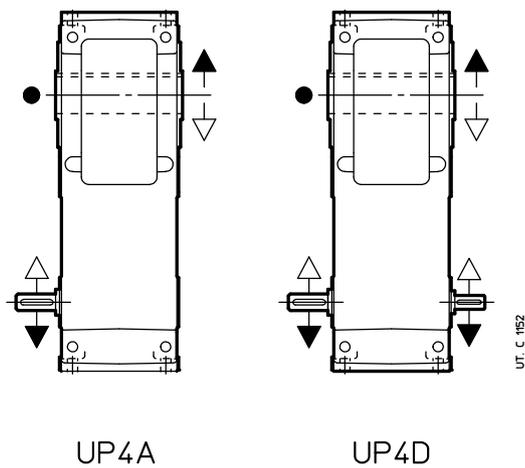

● Position of reference groove (see ch. 16) for radial load verification.

8 - Dimensions, designs, mounting positions (helical gear reducers)

Mounting positions

Unless otherwise stated, gear reducers are supplied in mounting position **B3** (see ch. 2).

R 2I 100, 125 – Long model

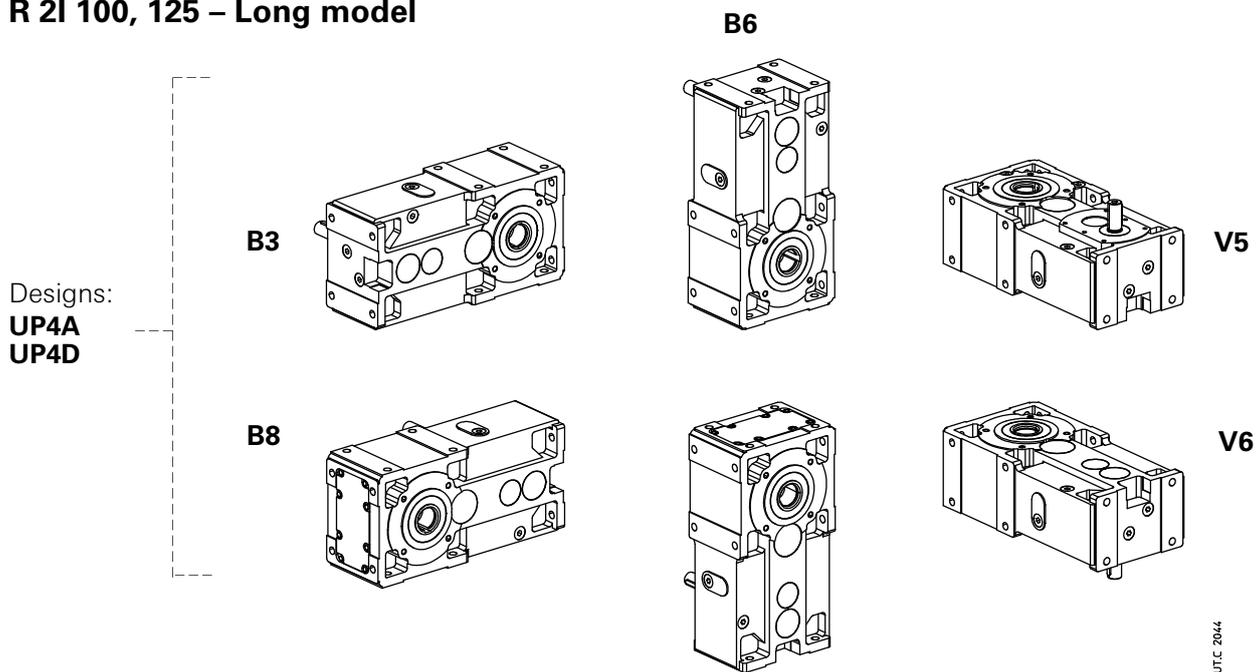

R 2I 140 ... 360 – Long model

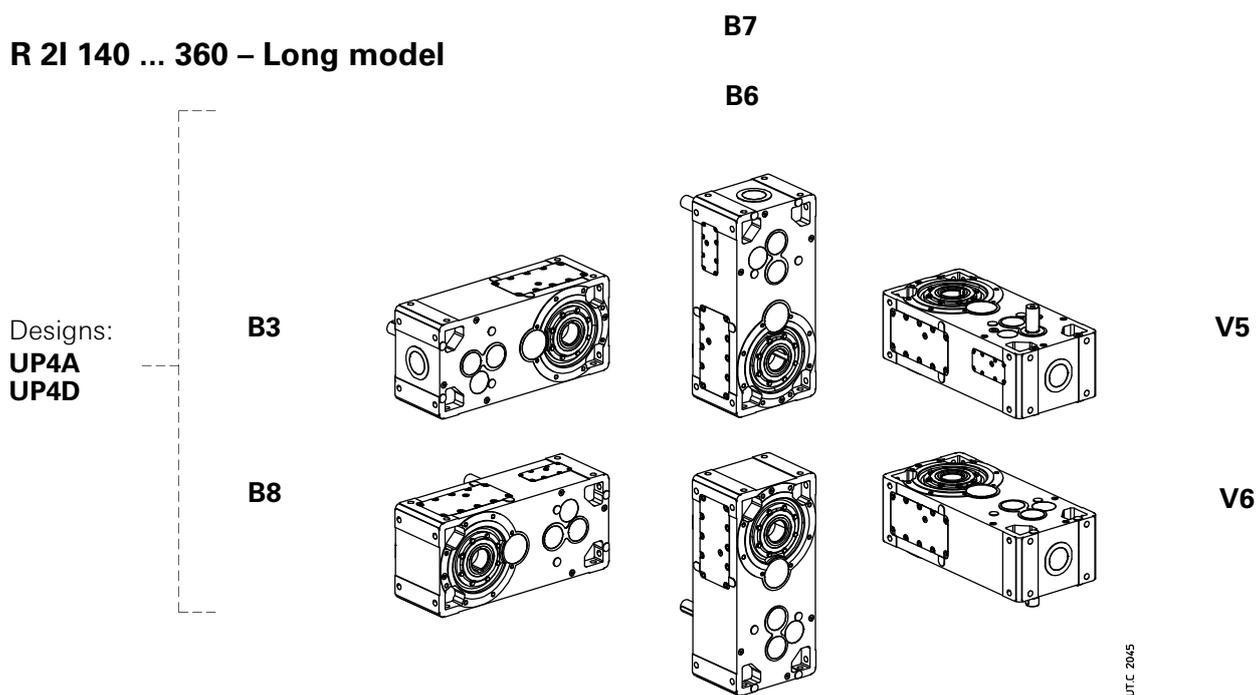

Oil quantity R 2I 100... 360 – Long model B7

Stated oil quantities [l] are approximate for provisioning. The exact oil quantity the gear reducer is to be filled with is defined by the level plug.

Mounting position	100	125	140	160	180	200	225	250	280	320, 321	360
B3	4,2	8	8,8	16	17,4	33	34	62	66	124	127
B8	4,2	8	8,8	16	17,4	33	34	62	66	124	127
B6	8	15,8	16,2	30	31	58	60	111	116	214	218
B7	7,6	14	15,2	28	29	54	56	103	108	199	202
V5	6,6	6,6	13,2	24	25	47	49	89	94	177	180
V6	12	12	13,2	24	25	47	49	89	94	177	180

8 - Dimensions, designs, mounting positions (helical gear reducers)

Lubrication details

R 2I 100, 125 – Long model

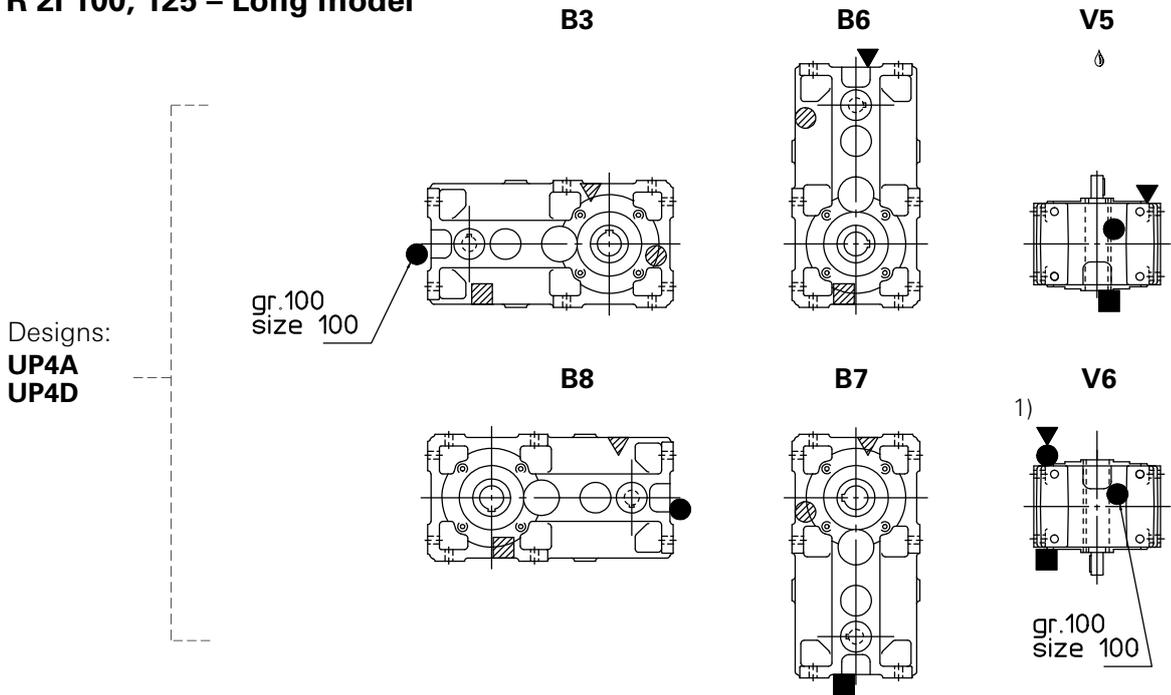

R 2I 140 ... 360 – Long model

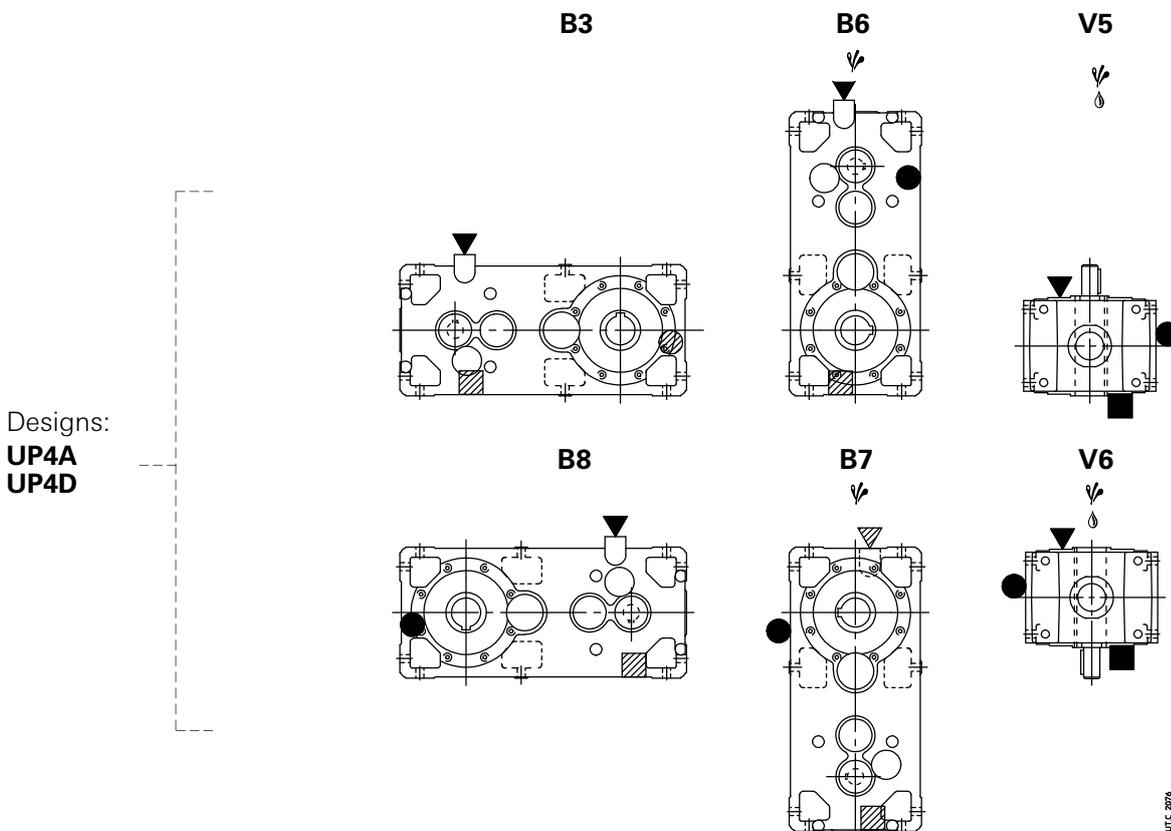

☼ Possible high oil splash: for the corrective factor f_{t3} of nominal thermal power P_{tN} see ch. 4.

☼ Possible bearing lubrication pump or lubrication device on high speed shaft (see ch. 17 (19)).

1) See also ch. 6 page. 43.

- ▼ oil filler plug
- oil level plug
- oil drain plug
- ▼● oil drain plug with oil level dip stick

- ▼ oil filler plug on opposite side (not in view)
- oil level plug on opposite side (not in view)
- oil drain plug on opposite side (not in view)

8 - Dimensions, designs, mounting positions (helical gear reducers)

8.5 - Gear reducers R 3I – Long model

Dimensions

R 3I 140 ... 360 – Long model

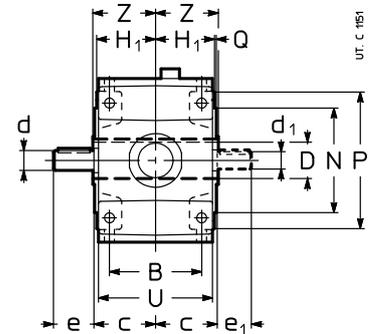
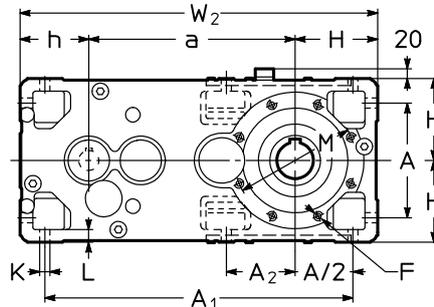
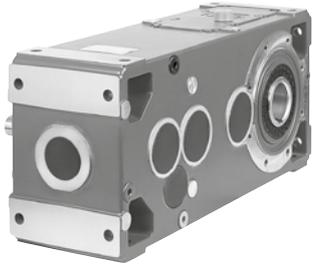

Size	a	A	A ₁	A ₂	B	c	D Ø H7	d Ø		e		d ₁ Ø	e ₁	F 1)	H h11	H ₁	h h11	K Ø	L	M Ø	N Ø h6	P Ø	Q	U	W ₂	Z	kg
								$i_N \leq 63$	$i_N \geq 71$																		
140	373	212	560	127	162	107	70	28	60	24	50	24	50	2)	150	103,5	125	18	23	265	230	300	4	201	648	125	124
160	450	252	672	–	201	132	80	32	80	28	60	28	60	M16	180	128,5	150	22	28	265	230	300	4	249	780	136	204
180	470	252	692	170	201	132	90	32	80	28	60	28	60	M16	180	128,5	150	22	28	300	250	350	5	249	800	150	222
200	556	320	831	–	250	162	100	42	110	38	80	38	80	2)	225	158	180	27	34	350	300	400	5	307	961	167	357
225	581	320	856	223	250	162	110	42	110	38	80	38	80	M20	225	158	180	27	34	400	350	450	5	307	986	180	389
250	690	396	1031	–	310	200	125	55	110	48	110	45	110	2)	280	195	225	33	42	500	450	550	5	380	1195	206	625
280	720	396	1061	277	310	200	140	55	110	48	110	45	110	M24	280	195	225	33	42	500	450	550	5	380	1225	222	682
320, 321	870	510	1305	–	386	245	160	70	140	55	110	55	110	2)	355	241	280	39	52	600	550	660	6	470	1505	254	1290
360	910	510	1345	358	386	245	180	70	140	55	110	55	110	M30	355	241	280	39	52	600	550	660	6	470	1545	273	1445

Designs (direction of rotation)

R 3I 140 ... 360 – Long model

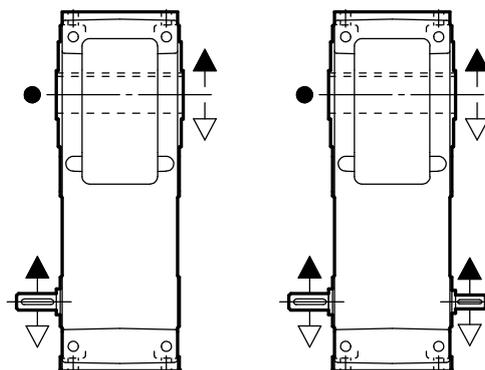

UP4A

UP4D

● Position of reference groove (see ch. 6) for radial load verification.

1) Working length of thread 2 · F.

2) For dimension, number and angular position see ch. 6.



8 - Dimensions, designs, mounting positions (helical gear reducers)

Mounting positions

Unless otherwise stated, gear reducers are supplied in mounting position **B3** (see ch. 2).

R 3I 140 ... 360 – Long model

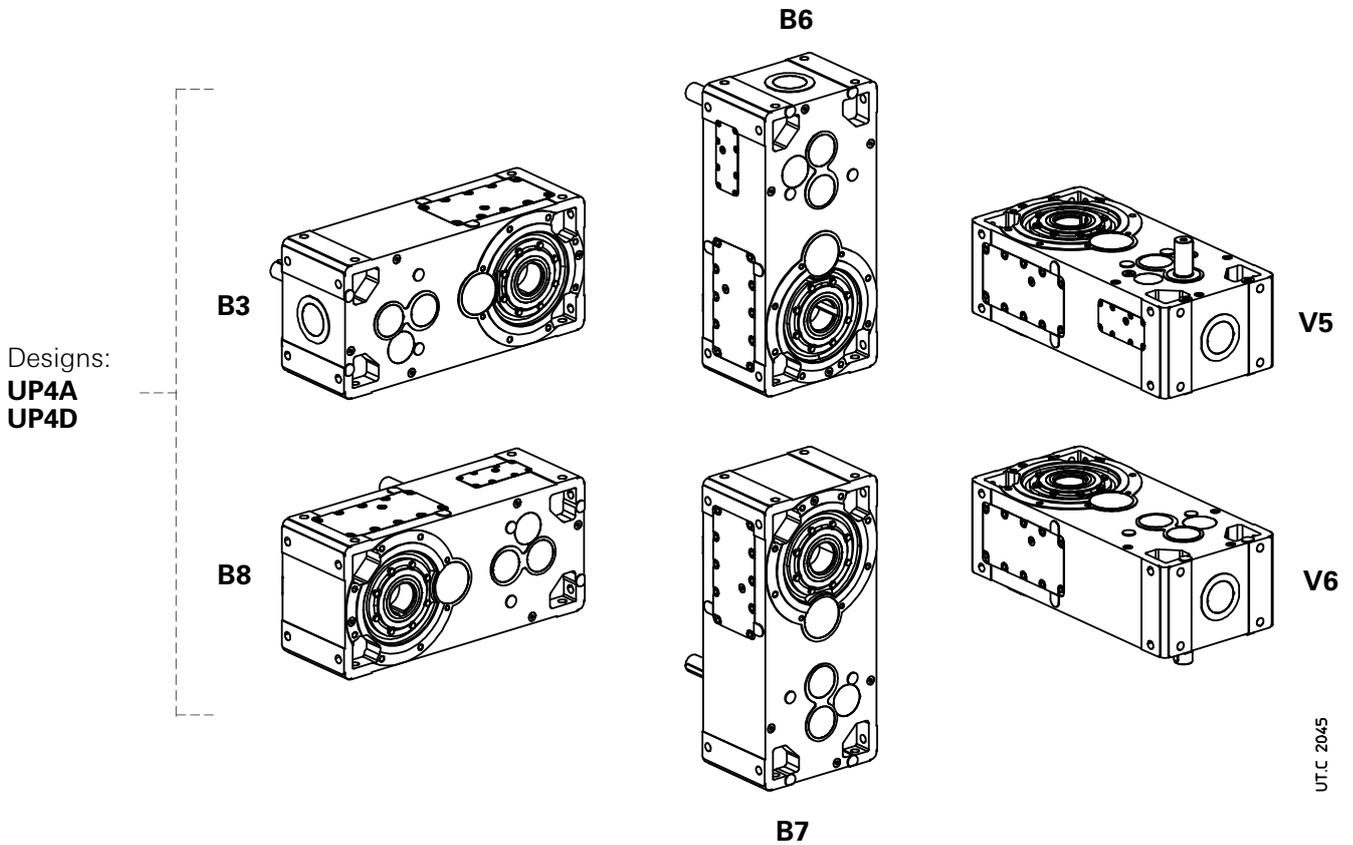

Oil quantity R 3I 140 ... 360 – Long model

Stated oil quantities [l] are approximate for provisioning. The exact oil quantity the gear reducer is to be filled with is defined by the level plug.

Mounting position	140	160	180	200	225	250	280	320, 321	360
B3	8,8	16	17,4	33	34	62	66	124	127
B8	12,2	22	23	43	45	82	87	164	167
B6	15,2	28	29	54	56	103	108	199	202
B7	15,2	28	29	54	56	103	108	199	202
V5	13,2	24	25	47	49	89	94	177	180
V6	13,2	24	25	47	49	89	94	177	180

8 - Dimensions, designs, mounting positions (helical gear reducers)

Lubrication details

R 3I 140 ... 360 – Long model

Design:
UP4A
UP4D

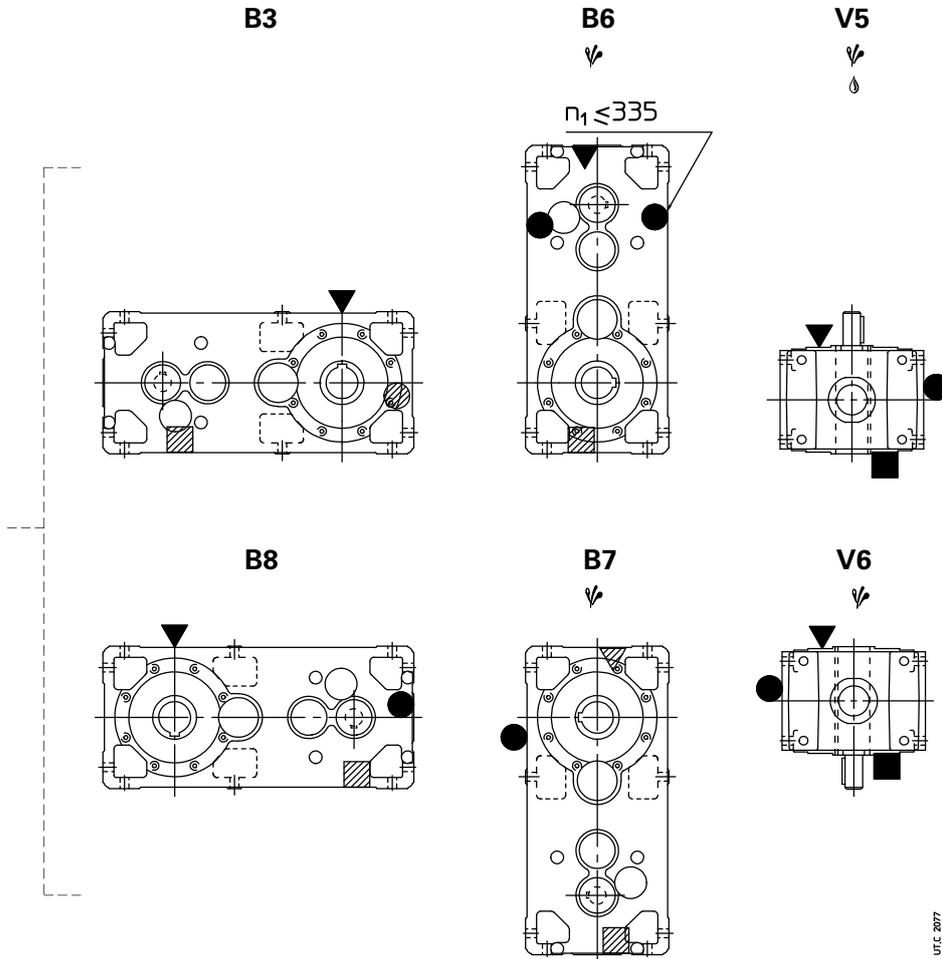

UTC 2077

▽ Possible high oil splash: for the corrective factor f_{t3} of nominal thermal power P_{tN} see ch. 4.

⚡ Possible bearing lubrication pump or lubrication device on high speed shaft (see ch. 17 (19)).

▽ oil filler plug
● oil level plug
■ oil drain plug

▽ oil filler plug on opposite side (not in view)
● oil level plug on opposite side (not in view)
■ oil drain plug on opposite side (not in view)

9 – Selection tables

(bevel helical gear reducers)

9 - Selection tables (bevel helical gear reducers)

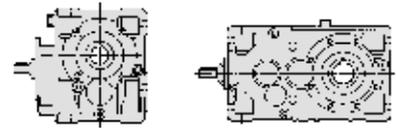

$n_{N2} \cdot L_h$ min ⁻¹ · h	i_N	P_{N2} kW M_{N2} N m ... / i																i_N	n_1	n_{N2} min ⁻¹	
		50	63	64	80	81	100	125	140	160	180	200	225	250	280	320	321				360
45 000 000	4	-	-	-	-	-	-	-	-	-	3 830 CI/4,1	-	7 480 CI/4	-	13 030 CI/3,9	16 290 CI/3,9	-				
40 000 000	4	-	-	-	-	-	-	-	-	-	3 930 CI/4,1	-	7 670 CI/4	-	13 380 CI/3,9	16 720 CI/3,9	-				
35 500 000	5	-	-	-	-	-	-	1 200 CI/5,06	-	2 280 CI/4,89	-	4 780 CI/5,11	-	9 450 CI/5,06	-	16 320 CI/4,89	20 390 CI/4,89	-			
	4	-	-	-	-	-	-	-	-	-	4 040 CI/4,1	-	7 880 CI/4	-	13 740 CI/3,9	17 180 CI/3,9	-				
31 500 000	5	-	-	-	-	-	-	1 230 CI/5,06	-	2 340 CI/4,89	-	4 900 CI/5,11	-	9 710 CI/5,06	-	16 750 CI/4,89	20 940 CI/4,89	-			
	4	-	-	-	-	-	-	-	-	-	4 140 CI/4,1	-	8 080 CI/4	-	14 090 CI/3,9	17 620 CI/3,9	-				
28 000 000	6,3	93 CI/6,53	165 CI/6,57	210 CI/6,57	355 CI/6,27	395 CI/6,27	730 CI/6,53	1 560 CI/6,57	-	2 930 CI/6,27	-	6 100 CI/6,53	-	12 280 CI/6,57	-	20 910 CI/6,27	26 140 CI/6,27	-			
	5	-	-	-	-	-	-	1 260 CI/5,06	-	2 410 CI/4,89	-	5 040 CI/5,11	-	9 970 CI/5,06	-	17 210 CI/4,89	21 510 CI/4,89	-			
	4	-	-	-	-	-	-	-	-	-	4 260 CI/4,1	-	8 320 CI/4	-	14 490 CI/3,9	18 120 CI/3,9	-				
25 000 000	6,3	95 CI/6,53	170 CI/6,57	215 CI/6,57	365 CI/6,27	410 CI/6,27	750 CI/6,53	1 600 CI/6,57	-	3 010 CI/6,27	-	6 270 CI/6,53	-	12 610 CI/6,57	-	21 470 CI/6,27	26 840 CI/6,27	-			
	5	-	-	-	-	-	-	1 300 CI/5,06	-	2 470 CI/4,89	-	5 170 CI/5,11	-	10 220 CI/5,06	-	17 650 CI/4,89	22 060 CI/4,89	-			
	4	-	-	-	-	-	-	-	-	-	4 390 CI/4,1	-	8 580 CI/4	-	14 960 CI/3,9	18 710 CI/3,9	-				
22 400 000	8	110 CI/7,85	200 CI/8	255 CI/8	440 CI/8,33	510 CI/8,33	875 CI/7,85	1 770 CI/8	2 180 CI/8,15	3 540 CI/8,27	4 440 CI/8,31	7 060 CI/8,27	8 560 CI/8,14	13 160 CI/8,21	17 140 CI/8,15	22 170 CI/7,83	27 610 CI/7,83	33 370 CI/8			
	6,3	98 CI/6,53	175 CI/6,57	220 CI/6,57	375 CI/6,27	420 CI/6,27	770 CI/6,53	1 640 CI/6,57	-	3 090 CI/6,27	-	6 440 CI/6,53	-	12 950 CI/6,57	-	22 060 CI/6,27	27 570 CI/6,27	-			
	5	-	-	-	-	-	-	1 330 CI/5,06	-	2 540 CI/4,89	-	5 310 CI/5,11	-	10 520 CI/5,06	-	18 150 CI/4,89	22 690 CI/4,89	-			
	4	-	-	-	-	-	-	-	-	-	4 510 CI/4,1	-	8 820 CI/4	-	15 370 CI/3,9	19 220 CI/3,9	-				
20 000 000	9	-	-	-	-	-	-	2 400 CI/9	3 620 CI/9,04	4 980 CI/9,33	7 150 CI/8,93	9 810 CI/9,33	14 480 CI/9,04	18 920 CI/9	24 760 CI/8,75	30 840 CI/8,75	37 400 CI/9,2				
	8	110 CI/7,85	205 CI/8	260 CI/8	450 CI/8,33	520 CI/8,33	900 CI/7,85	1 820 CI/8	2 230 CI/8,15	3 630 CI/8,27	4 550 CI/8,31	7 250 CI/8,27	8 790 CI/8,14	13 510 CI/8,21	17 600 CI/8,15	22 760 CI/7,83	28 340 CI/7,83	34 260 CI/8			

For n_1 lower than 560 min⁻¹ see page 195.

9 - Selection tables (bevel helical gear reducers)

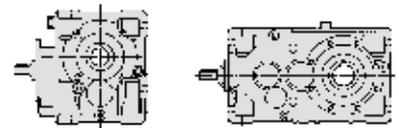

$n_{N2} \cdot L_h$ min ⁻¹ · h	i_N	P_{N2} kW																i_N	n_1 min ⁻¹	n_{N2} min ⁻¹	
		M_{N2} N m																			
		... / i																			
		50	63	64	80	81	100	125	140	160	180	200	225	250	280	320	321	360			
20 000 000	6,3	100 CI/6,53	180 CI/6,57	225 CI/6,57	385 CI/6,27	430 CI/6,27	790 CI/6,53	1 680 CI/6,57	-	3 170 CI/6,27	-	6 600 CI/6,53	-	13 280 CI/6,57	-	22 620 CI/6,27	28 270 CI/6,27	-			
	5	-	-	-	-	-	-	1 380 CI/5,06	-	2 620 CI/4,89	-	5 480 CI/5,11	-	10 860 CI/5,06	-	18 740 CI/4,89	23 420 CI/4,89	-			
	4	-	-	-	-	-	-	-	-	-	-	4 630 CI/4,1	-	9 050 CI/4	-	15 780 CI/3,9	19 730 CI/3,9	-			
18 000 000	10	105 CI/10,3	210 CI/10	255 CI/10	440 CI/10,4	510 CI/10,4	895 CI/9,81	1 790 CI/10	2 310 CI/10,2	3 610 CI/10,3	4 710 CI/10,4	7 200 CI/10,3	9 100 CI/10,2	14 370 CI/10	18 230 CI/10,2	25 590 CI/10,2	31 330 CI/10,2	35 240 CI/10			
	9	-	-	-	-	-	-	-	2 470 CI/9	3 720 CI/9,04	5 120 CI/9,33	7 340 CI/8,93	10 070 CI/9,33	14 860 CI/9,04	19 420 CI/9	25 420 CI/8,75	31 650 CI/8,75	38 390 CI/9,2			
	8	115 CI/7,85	210 CI/8	265 CI/8	460 CI/8,33	535 CI/8,33	925 CI/7,85	1 870 CI/8	2 300 CI/8,15	3 730 CI/8,27	4 680 CI/8,31	7 450 CI/8,27	9 030 CI/8,14	13 880 CI/8,21	18 080 CI/8,15	23 380 CI/7,83	29 110 CI/7,83	35 200 CI/8			
	6,3	105 CI/6,53	185 CI/6,57	230 CI/6,57	395 CI/6,27	440 CI/6,27	810 CI/6,53	1 730 CI/6,57	-	3 260 CI/6,27	-	6 790 CI/6,53	-	13 660 CI/6,57	-	23 260 CI/6,27	29 080 CI/6,27	-			
	5	-	-	-	-	-	-	1 410 CI/5,06	-	2 690 CI/4,89	-	5 630 CI/5,11	-	11 150 CI/5,06	-	19 250 CI/4,89	24 060 CI/4,89	-			
	4	-	-	-	-	-	-	-	-	-	-	4 760 CI/4,1	-	9 300 CI/4	-	16 210 CI/3,9	20 270 CI/3,9	-			
16 000 000	11,2	-	-	-	-	-	-	-	2 480 CI/11,3	3 380 CI/11,4	5 260 CI/11,7	6 670 CI/11,3	10 430 CI/11,7	13 510 CI/11,4	20 120 CI/11,3	23 360 CI/11	29 200 CI/11	38 140 CI/11,5			
	10	105 CI/10,3	215 CI/10	260 CI/10	455 CI/10,4	525 CI/10,4	920 CI/9,81	1 840 CI/10	2 370 CI/10,2	3 700 CI/10,3	4 840 CI/10,4	7 390 CI/10,3	9 350 CI/10,2	14 750 CI/10	18 720 CI/10,2	26 270 CI/10,2	32 160 CI/10,2	36 180 CI/10			
	9	-	-	-	-	-	-	-	2 530 CI/9	3 820 CI/9,04	5 260 CI/9,33	7 540 CI/8,93	10 350 CI/9,33	15 270 CI/9,04	19 960 CI/9	26 120 CI/8,75	32 520 CI/8,75	39 440 CI/9,2			
	8	115 CI/7,85	215 CI/8	275 CI/8	475 CI/8,33	550 CI/8,33	950 CI/7,85	1 920 CI/8	2 350 CI/8,15	3 830 CI/8,27	4 800 CI/8,31	7 640 CI/8,27	9 260 CI/8,14	14 230 CI/8,21	18 540 CI/8,15	23 980 CI/7,83	29 860 CI/7,83	36 090 CI/8			
	6,3	105 CI/6,53	190 CI/6,57	240 CI/6,57	410 CI/6,27	455 CI/6,27	840 CI/6,53	1 790 CI/6,57	-	3 360 CI/6,27	-	7 010 CI/6,53	-	14 100 CI/6,57	-	24 020 CI/6,27	30 020 CI/6,27	-			
	5	-	-	-	-	-	-	1 450 CI/5,06	-	2 770 CI/4,89	-	5 780 CI/5,11	-	11 450 CI/5,06	-	19 760 CI/4,89	24 700 CI/4,89	-			
4	-	-	-	-	-	-	-	-	-	-	4 830 CI/4,1	-	9 430 CI/4	-	16 440 CI/3,9	20 540 CI/3,9	-				
14 000 000	12,5	110 CI/12,4	200 CI/12,6	255 CI/12,6	445 CI/13,1	515 CI/13,1	875 CI/12,4	1 820 CI/12,6	2 180 CI/12,9	3 860 CI/13	4 440 CI/13,1	7 720 CI/13	8 560 CI/12,8	14 950 CI/12,6	17 140 CI/12,9	23 190 CI/12,8	28 390 CI/12,8	33 370 CI/12,6			
	11,2	-	-	-	-	-	-	-	2 540 CI/11,3	3 470 CI/11,4	5 400 CI/11,7	6 850 CI/11,3	10 710 CI/11,7	13 870 CI/11,4	20 660 CI/11,3	23 980 CI/11	29 980 CI/11	39 160 CI/11,5			

For n_1 lower than 560 min⁻¹ see page 195.

9 - Selection tables (bevel helical gear reducers)

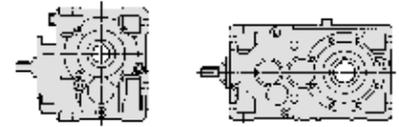

$n_{N2} \cdot L_h$ min ⁻¹ · h	i_N	P_{N2} kW																i_N	n_1 min ⁻¹	n_{N2} min ⁻¹	
		M_{N2} N m																			
		... / i																			
		50	63	64	80	81	100	125	140	160	180	200	225	250	280	320	321	360			
14 000 000	10	110 CI/10,3	220 CI/10	270 CI/10	465 CI/10,4	540 CI/10,4	945 CI/9,81	1 890 CI/10	2 440 CI/10,2	3 810 CI/10,3	4 970 CI/10,4	7 590 CI/10,3	9 600 CI/10,2	15 160 CI/10	19 230 CI/10,2	26 990 CI/10,2	33 050 CI/10,2	37 170 CI/10			
	9	-	-	-	-	-	-	-	2 600 CI/9	3 910 CI/9,04	5 390 CI/9,33	7 730 CI/8,93	10 610 CI/9,33	15 660 CI/9,04	20 460 CI/9	26 780 CI/8,75	33 350 CI/8,75	40 450 CI/9,2			
	8	120 CI/7,85	225 CI/8	280 CI/8	490 CI/8,33	565 CI/8,33	975 CI/7,85	1 970 CI/8	2 420 CI/8,15	3 930 CI/8,27	4 930 CI/8,31	7 860 CI/8,27	9 520 CI/8,14	14 640 CI/8,21	19 070 CI/8,15	24 660 CI/7,83	30 710 CI/7,83	37 120 CI/8			
	6,3	110 CI/6,53	195 CI/6,57	245 CI/6,57	420 CI/6,27	470 CI/6,27	860 CI/6,53	1 840 CI/6,57	-	3 450 CI/6,27	-	7 200 CI/6,53	-	14 490 CI/6,57	-	24 670 CI/6,27	30 840 CI/6,27	-			
	5	-	-	-	-	-	-	1 490 CI/5,06	-	2 840 CI/4,89	-	5 940 CI/5,11	-	11 760 CI/5,06	-	20 300 CI/4,89	25 380 CI/4,89	-			
	4	-	-	-	-	-	-	-	-	-	-	4 890 CI/4,1	-	9 550 CI/4	-	16 640 CI/3,9	20 800 CI/3,9	-			
12 500 000	14	-	-	-	-	-	-	-	2 400 CI/14,2	3 760 CI/14,2	4 980 CI/14,7	7 680 CI/14,2	9 810 CI/14,7	15 350 CI/14,1	18 920 CI/14,2	24 610 CI/14,2	29 210 CI/14,2	38 380 CI/14,5			
	12,5	110 CI/12,4	205 CI/12,6	260 CI/12,6	455 CI/13,1	530 CI/13,1	900 CI/12,4	1 870 CI/12,6	2 230 CI/12,9	3 960 CI/13	4 550 CI/13,1	7 930 CI/13	8 790 CI/12,8	15 350 CI/12,6	17 600 CI/12,9	23 800 CI/12,8	29 140 CI/12,8	34 260 CI/12,6			
	11,2	-	-	-	-	-	-	-	2 610 CI/11,3	3 560 CI/11,4	5 550 CI/11,7	7 040 CI/11,3	11 000 CI/11,7	14 250 CI/11,4	21 220 CI/11,3	24 640 CI/11	30 800 CI/11	40 230 CI/11,5			
	10	110 CI/10,3	225 CI/10	275 CI/10	475 CI/10,4	555 CI/10,4	970 CI/9,81	1 940 CI/10	2 500 CI/10,2	3 900 CI/10,3	5 100 CI/10,4	7 780 CI/10,3	9 850 CI/10,2	15 540 CI/10	19 720 CI/10,2	27 670 CI/10,2	33 890 CI/10,2	38 110 CI/10			
	9	-	-	-	-	-	-	-	2 670 CI/9	4 030 CI/9,04	5 540 CI/9,33	7 950 CI/8,93	10 910 CI/9,33	16 100 CI/9,04	21 050 CI/9	27 540 CI/8,75	34 300 CI/8,75	41 600 CI/9,2			
	8	125 CI/7,85	230 CI/8	290 CI/8	505 CI/8,33	585 CI/8,33	1 010 CI/7,85	2 030 CI/8	2 500 CI/8,15	4 060 CI/8,27	5 090 CI/8,31	8 110 CI/8,27	9 830 CI/8,14	15 110 CI/8,21	19 690 CI/8,15	25 460 CI/7,83	31 700 CI/7,83	38 320 CI/8			
	6,3	110 CI/6,53	200 CI/6,57	250 CI/6,57	430 CI/6,27	480 CI/6,27	885 CI/6,53	1 890 CI/6,57	-	3 550 CI/6,27	-	7 390 CI/6,53	-	14 870 CI/6,57	-	25 330 CI/6,27	31 660 CI/6,27	-			
	5	-	-	-	-	-	-	1 510 CI/5,06	-	2 880 CI/4,89	-	6 020 CI/5,11	-	11 920 CI/5,06	-	20 580 CI/4,89	25 720 CI/4,89	-			
4	-	-	-	-	-	-	-	-	-	-	4 960 CI/4,1	-	9 680 CI/4	-	16 880 CI/3,9	21 100 CI/3,9	-				
11 200 000	16	96 CI/15,2	180 CI/15,8	220 CI/15,8	385 CI/16,4	445 CI/16,4	790 CI/15,2	1 580 CI/15,8	2 300 CI/15,8	3 440 CI/15,5	4 870 CI/16	7 080 CI/15,5	9 680 CI/16	14 160 CI/16	19 380 CI/15,8	23 070 CI/16,3	28 770 CI/16,3	36 930 CI/16			
	14	-	-	-	-	-	-	-	2 470 CI/14,2	3 860 CI/14,2	5 120 CI/14,7	7 880 CI/14,2	10 070 CI/14,7	15 760 CI/14,1	19 420 CI/14,2	25 270 CI/14,2	29 980 CI/14,2	39 400 CI/14,5			
	12,5	115 CI/12,4	210 CI/12,6	265 CI/12,6	470 CI/13,1	540 CI/13,1	925 CI/12,4	1 920 CI/12,6	2 300 CI/12,9	4 070 CI/13	4 680 CI/13,1	8 150 CI/13	9 030 CI/12,8	15 770 CI/12,6	18 080 CI/12,9	24 460 CI/12,8	29 940 CI/12,8	35 200 CI/12,6			

For n_1 lower than 560 min⁻¹ see page 195.

9 - Selection tables (bevel helical gear reducers)

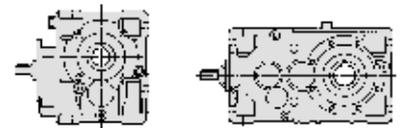

$n_{N2} \cdot L_h$ min ⁻¹ · h	i_N	P_{N2} kW																i_N	n_1	n_{N2} min ⁻¹	
		M_{N2} N m																			
		... / i																			
		50	63	64	80	81	100	125	140	160	180	200	225	250	280	320	321	360			
11 200 000	11,2	-	-	-	-	-	-	-	2 680 CI/11,3	3 650 CI/11,4	5 690 CI/11,7	7 220 CI/11,3	11 280 CI/11,7	14 610 CI/11,4	21 760 CI/11,3	25 260 CI/11	31 580 CI/11	41 250 CI/11,5			
	10	115 CI/10,3	230 CI/10	285 CI/10	490 CI/10,4	570 CI/10,4	1000 CI/9,81	2 000 CI/10	2 570 CI/10,2	4 010 CI/10,3	5 240 CI/10,4	8 010 CI/10,3	10 130 CI/10,2	15 990 CI/10	20 280 CI/10,2	28 460 CI/10,2	34 850 CI/10,2	39 200 CI/10			
	9	-	-	-	-	-	-	-	2 760 CI/9	4 160 CI/9,04	5 720 CI/9,33	8 210 CI/8,93	11 270 CI/9,33	16 630 CI/9,04	21 730 CI/9	28 440 CI/8,75	35 410 CI/8,75	42 940 CI/9,2			
	8	125 CI/7,85	235 CI/8	300 CI/8	515 CI/8,33	600 CI/8,33	1 030 CI/7,85	2 090 CI/8	2 570 CI/8,15	4 170 CI/8,27	5 230 CI/8,31	8 330 CI/8,27	10 100 CI/8,14	15 520 CI/8,21	20 230 CI/8,15	26 150 CI/7,83	32 570 CI/7,83	39 370 CI/8			
	6,3	115 CI/6,53	205 CI/6,57	260 CI/6,57	440 CI/6,27	495 CI/6,27	910 CI/6,53	1 940 CI/6,57	-	3 640 CI/6,27	-	7 600 CI/6,53	-	15 280 CI/6,57	-	26 020 CI/6,27	32 530 CI/6,27	-			
	5	-	-	-	-	-	-	1 530 CI/5,06	-	2 920 CI/4,89	-	6 100 CI/5,11	-	12 080 CI/5,06	-	20 840 CI/4,89	26 050 CI/4,89	-			
	4	-	-	-	-	-	-	-	-	-	-	5 030 CI/4,1	-	9 820 CI/4	-	17 120 CI/3,9	21 400 CI/3,9	-			
10 000 000	18	-	-	-	-	-	-	-	2 330 CI/18	3 660 CI/18	4 830 CI/18,7	7 300 CI/18	9 560 CI/18,7	14 520 CI/17,9	18 470 CI/18	22 330 CI/18	28 200 CI/18	37 460 CI/18,4			
	16	99 CI/15,2	185 CI/15,8	230 CI/15,8	395 CI/16,4	455 CI/16,4	815 CI/15,2	1 620 CI/15,8	2 360 CI/15,8	3 540 CI/15,5	5 000 CI/16	7 270 CI/15,5	9 930 CI/16	14 530 CI/16	19 900 CI/15,8	23 680 CI/16,3	29 540 CI/16,3	37 910 CI/16			
	14	-	-	-	-	-	-	-	2 530 CI/14,2	3 960 CI/14,2	5 260 CI/14,7	8 100 CI/14,2	10 350 CI/14,7	16 190 CI/14,1	19 960 CI/14,2	25 960 CI/14,2	30 800 CI/14,2	40 480 CI/14,5			
	12,5	120 CI/12,4	215 CI/12,6	275 CI/12,6	480 CI/13,1	555 CI/13,1	950 CI/12,4	1 970 CI/12,6	2 350 CI/12,9	4 180 CI/13	4 800 CI/13,1	8 350 CI/13	9 260 CI/12,8	16 170 CI/12,6	18 540 CI/12,9	25 080 CI/12,8	30 700 CI/12,8	36 090 CI/12,6			
	11,2	-	-	-	-	-	-	-	2 760 CI/11,3	3 760 CI/11,4	5 850 CI/11,7	7 420 CI/11,3	11 610 CI/11,7	15 030 CI/11,4	22 380 CI/11,3	25 980 CI/11	32 480 CI/11	42 430 CI/11,5			
	10	120 CI/10,3	240 CI/10	295 CI/10	505 CI/10,4	585 CI/10,4	1 030 CI/9,81	2 060 CI/10	2 660 CI/10,2	4 140 CI/10,3	5 410 CI/10,4	8 270 CI/10,3	10 450 CI/10,2	16 500 CI/10	20 940 CI/10,2	29 380 CI/10,2	35 980 CI/10,2	40 470 CI/10			
	9	-	-	-	-	-	-	-	2 830 CI/9	4 270 CI/9,04	5 880 CI/9,33	8 440 CI/8,93	11 580 CI/9,33	17 080 CI/9,04	22 320 CI/9	29 210 CI/8,75	36 380 CI/8,75	44 120 CI/9,2			
	8	130 CI/7,85	245 CI/8	305 CI/8	530 CI/8,33	615 CI/8,33	1 060 CI/7,85	2 150 CI/8	2 640 CI/8,15	4 280 CI/8,27	5 370 CI/8,31	8 550 CI/8,27	10 370 CI/8,14	15 940 CI/8,21	20 760 CI/8,15	26 850 CI/7,83	33 430 CI/7,83	40 420 CI/8			
	6,3	115 CI/6,53	205 CI/6,57	265 CI/6,57	450 CI/6,27	500 CI/6,27	920 CI/6,53	1 960 CI/6,57	-	3 690 CI/6,27	-	7 700 CI/6,53	-	15 490 CI/6,57	-	26 380 CI/6,27	32 970 CI/6,27	-			
	5	-	-	-	-	-	-	1 550 CI/5,06	-	2 960 CI/4,89	-	6 190 CI/5,11	-	12 250 CI/5,06	-	21 130 CI/4,89	26 420 CI/4,89	-			
4	-	-	-	-	-	-	-	-	-	-	5 100 CI/4,1	-	9 960 CI/4	-	17 370 CI/3,9	21 710 CI/3,9	-				

For n_1 lower than 560 min⁻¹ see page 195.

9 - Selection tables (bevel helical gear reducers)

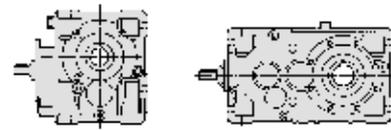

$n_{N2} \cdot L_h$ min ⁻¹ · h	i_N	P_{N2} kW M_{N2} N m ... / i																i_N	n_1	n_{N2} min ⁻¹	
		50	63	64	80	81	100	125	140	160	180	200	225	250	280	320	321				360
9 000 000	20	-	-	-	-	-	-	-	2 500 C21/20,4	4 250 C21/20,6	5 590 C21/21,4	8 620 C21/20,5	10 410 C21/19,9	17 350 C21/21,5	21 450 C21/20,8	30 370 C21/20,6	37 700 C21/20,6	43 990 C21/21,4			
	20	97 CI/19,3	180 CI/20	225 CI/20	385 CI/20,8	445 CI/20,8	800 CI/19,3	1 600 CI/20	2 300 CI/20	3 490 CI/19,7	4 600 CI/20,3	7 170 CI/19,7	9 210 CI/20,3	14 340 CI/20,3	18 190 CI/20	23 510 CI/19,7	28 080 CI/19,7	35 880 CI/20,3			
	18	-	-	-	-	-	-	-	2 390 CI/18	3 760 CI/18	4 960 CI/18,7	7 490 CI/18	9 820 CI/18,7	14 900 CI/17,9	18 960 CI/18	22 920 CI/18	28 940 CI/18	38 450 CI/18,4			
	16	100 CI/15,2	190 CI/15,8	235 CI/15,8	405 CI/16,4	470 CI/16,4	835 CI/15,2	1 670 CI/15,8	2 420 CI/15,8	3 630 CI/15,5	5 130 CI/16	7 470 CI/15,5	10 210 CI/16	14 930 CI/16	20 440 CI/15,8	24 330 CI/16,3	30 340 CI/16,3	38 950 CI/16			
	14	-	-	-	-	-	-	-	2 600 CI/14,2	4 060 CI/14,2	5 390 CI/14,7	8 300 CI/14,2	10 610 CI/14,7	16 610 CI/14,1	20 460 CI/14,2	26 620 CI/14,2	31 590 CI/14,2	41 510 CI/14,5			
	12,5	120 CI/12,4	225 CI/12,6	280 CI/12,6	495 CI/13,1	570 CI/13,1	975 CI/12,4	2 020 CI/12,6	2 420 CI/12,9	4 300 CI/13	4 930 CI/13,1	8 590 CI/13	9 520 CI/12,8	16 630 CI/12,6	19 070 CI/12,9	25 790 CI/12,8	31 580 CI/12,8	37 120 CI/12,6			
	11,2	-	-	-	-	-	-	-	2 840 CI/11,3	3 880 CI/11,4	6 040 CI/11,7	7 660 CI/11,3	11 980 CI/11,7	15 520 CI/11,4	23 110 CI/11,3	26 830 CI/11	33 530 CI/11	43 800 CI/11,5			
	10	120 CI/10,3	245 CI/10	300 CI/10	520 CI/10,4	605 CI/10,4	1 060 CI/9,81	2 120 CI/10	2 730 CI/10,2	4 260 CI/10,3	5 560 CI/10,4	8 490 CI/10,3	10 740 CI/10,2	16 960 CI/10	21 510 CI/10,2	30 190 CI/10,2	36 970 CI/10,2	41 580 CI/10			
	9	-	-	-	-	-	-	-	2 910 CI/9	4 380 CI/9,04	6 040 CI/9,33	8 660 CI/8,93	11 880 CI/9,33	17 540 CI/9,04	22 920 CI/9	29 990 CI/8,75	37 350 CI/8,75	45 290 CI/9,2			
	8	135 CI/7,85	250 CI/8	315 CI/8	545 CI/8,33	630 CI/8,33	1 090 CI/7,85	2 200 CI/8	2 710 CI/8,15	4 400 CI/8,27	5 520 CI/8,31	8 790 CI/8,27	10 650 CI/8,14	16 370 CI/8,21	21 330 CI/8,15	27 580 CI/7,83	34 350 CI/7,83	41 530 CI/8			
	6,3	120 CI/6,53	210 CI/6,57	265 CI/6,57	455 CI/6,27	510 CI/6,27	935 CI/6,53	1 990 CI/6,57	-	3 740 CI/6,27	-	7 800 CI/6,53	-	15 690 CI/6,57	-	26 710 CI/6,27	33 390 CI/6,27	-			
5	-	-	-	-	-	-	1 570 CI/5,06	-	3 000 CI/4,89	-	6 280 CI/5,11	-	12 420 CI/5,06	-	21 440 CI/4,89	26 800 CI/4,89	-				
4	-	-	-	-	-	-	-	-	-	-	5 170 CI/4,1	-	10 100 CI/4	-	17 610 CI/3,9	22 020 CI/3,9	-				
8 000 000	22,4	-	-	-	-	-	-	2 870 C21/23,8	4 250 C21/23,8	6 070 C21/23,7	8 620 C21/22,4	12 020 C21/23	17 350 C21/23,6	23 950 C21/23,8	30 370 C21/23	37 800 C21/23	47 910 C21/23,7				
	20	-	-	-	-	-	-	2 570 C21/20,4	4 360 C21/20,6	5 730 C21/21,4	8 850 C21/20,5	10 690 C21/19,9	17 810 C21/21,5	22 010 C21/20,8	31 170 C21/20,6	38 700 C21/20,6	45 150 C21/21,4				
	20	99 CI/19,3	185 CI/20	230 CI/20	400 CI/20,8	460 CI/20,8	825 CI/19,3	1 640 CI/20	2 360 CI/20	3 580 CI/19,7	4 730 CI/20,3	7 360 CI/19,7	9 450 CI/20,3	14 720 CI/20,3	18 670 CI/20	24 130 CI/19,7	28 820 CI/19,7	36 830 CI/20,3			
	18	-	-	-	-	-	-	2 450 CI/18	3 860 CI/18	5 090 CI/18,7	7 700 CI/18	10 090 CI/18,7	15 310 CI/17,9	19 480 CI/18	23 550 CI/18	29 740 CI/18	39 510 CI/18,4				
	16	105 CI/15,2	195 CI/15,8	240 CI/15,8	415 CI/16,4	480 CI/16,4	855 CI/15,2	1 710 CI/15,8	2 490 CI/15,8	3 730 CI/15,5	5 270 CI/16	7 660 CI/15,5	10 470 CI/16	15 310 CI/16	20 960 CI/15,8	24 950 CI/16,3	31 120 CI/16,3	39 940 CI/16			

For n_1 lower than 560 min⁻¹ see page 195.

9 - Selection tables (bevel helical gear reducers)

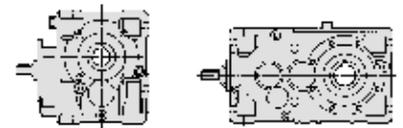

$n_{N2} \cdot L_h$ min ⁻¹ · h	i_N	P_{N2} kW																i_N	n_1 min ⁻¹	n_{N2} min ⁻¹	
		M_{N2} N m																			
		... / i																			
		50	63	64	80	81	100	125	140	160	180	200	225	250	280	320	321	360			
8 000 000	14	-	-	-	-	-	-	-	2 670 CI/14,2	4 180 CI/14,2	5 540 CI/14,7	8 540 CI/14,2	10 910 CI/14,7	17 080 CI/14,1	21 050 CI/14,2	27 380 CI/14,2	32 490 CI/14,2	42 690 CI/14,5			
	12,5	125 CI/12,4	230 CI/12,6	290 CI/12,6	510 CI/13,1	590 CI/13,1	1 010 CI/12,4	2 090 CI/12,6	2 500 CI/12,9	4 440 CI/13	5 090 CI/13,1	8 870 CI/13	9 830 CI/12,8	17 170 CI/12,6	19 690 CI/12,9	26 630 CI/12,8	32 600 CI/12,8	38 320 CI/12,6			
	11,2	-	-	-	-	-	-	-	2 920 CI/11,3	3 990 CI/11,4	6 210 CI/11,7	7 870 CI/11,3	12 310 CI/11,7	15 940 CI/11,4	23 740 CI/11,3	27 560 CI/11	34 450 CI/11	45 000 CI/11,5			
	10	125 CI/10,3	255 CI/10	310 CI/10	535 CI/10,4	620 CI/10,4	1 090 CI/9,81	2 170 CI/10	2 800 CI/10,2	4 370 CI/10,3	5 710 CI/10,4	8 720 CI/10,3	11 030 CI/10,2	17 410 CI/10	22 080 CI/10,2	30 990 CI/10,2	37 950 CI/10,2	42 680 CI/10			
	9	-	-	-	-	-	-	-	2 990 CI/9	4 500 CI/9,04	6 200 CI/9,33	8 900 CI/8,93	12 210 CI/9,33	18 020 CI/9,04	23 540 CI/9	30 810 CI/8,75	38 370 CI/8,75	46 530 CI/9,2			
	8	135 CI/7,85	255 CI/8	320 CI/8	555 CI/8,33	640 CI/8,33	1 110 CI/7,85	2 230 CI/8	2 750 CI/8,15	4 460 CI/8,27	5 590 CI/8,31	8 910 CI/8,27	10 800 CI/8,14	16 600 CI/8,21	21 620 CI/8,15	27 960 CI/7,83	34 820 CI/7,83	42 090 CI/8			
	6,3	120 CI/6,53	215 CI/6,57	270 CI/6,57	460 CI/6,27	515 CI/6,27	945 CI/6,53	2 020 CI/6,57	-	3 790 CI/6,27	-	7 910 CI/6,53	-	15 910 CI/6,57	-	27 090 CI/6,27	33 860 CI/6,27	-			
	5	-	-	-	-	-	-	1 600 CI/5,06	-	3 040 CI/4,89	-	6 370 CI/5,11	-	12 600 CI/5,06	-	21 740 CI/4,89	27 180 CI/4,89	-			
4	-	-	-	-	-	-	-	-	-	-	5 240 CI/4,1	-	10 240 CI/4	-	17 850 CI/3,9	22 320 CI/3,9	-				
7 100 000	25	-	-	-	-	-	-	2 710 C2I/24,5	4 290 C2I/25,1	5 640 C2I/26	8 720 C2I/27	12 060 C2I/26,3	17 500 C2I/27,2	24 180 C2I/26,4	30 650 C2I/25,1	38 140 C2I/25,1	48 360 C2I/26				
	25	97 CI/24,1	190 CI/25	240 CI/25	390 CI/26	450 CI/26	740 CI/24,1	1 620 CI/25	-	3 200 CI/24,6	-	6 410 CI/24,6	-	13 110 CI/25,4	-	-	-	-			
	22,4	-	-	-	-	-	-	-	2 940 C2I/23,8	4 360 C2I/23,8	6 230 C2I/23,7	8 850 C2I/22,4	12 340 C2I/23	17 810 C2I/23,6	24 580 C2I/23,8	31 170 C2I/23	38 810 C2I/23	49 180 C2I/23,7			
	20	-	-	-	-	-	-	-	2 640 C2I/20,4	4 480 C2I/20,6	5 890 C2I/21,4	9 100 C2I/20,5	10 980 C2I/19,9	18 300 C2I/21,5	22 620 C2I/20,8	32 030 C2I/20,6	39 760 C2I/20,6	46 390 C2I/21,4			
	20	100 CI/19,3	190 CI/20	235 CI/20	410 CI/20,8	480 CI/20,8	845 CI/19,3	1 690 CI/20	2 430 CI/20	3 680 CI/19,7	4 860 CI/20,3	7 560 CI/19,7	9 710 CI/20,3	15 120 CI/20,3	19 180 CI/20	24 800 CI/19,7	29 610 CI/19,7	37 840 CI/20,3			
	18	-	-	-	-	-	-	-	2 520 CI/18	3 960 CI/18	5 220 CI/18,7	7 890 CI/18	10 340 CI/18,7	15 700 CI/17,9	19 980 CI/18	24 150 CI/18	30 490 CI/18	40 510 CI/18,4			
	16	105 CI/15,2	200 CI/15,8	245 CI/15,8	430 CI/16,4	500 CI/16,4	880 CI/15,2	1 760 CI/15,8	2 560 CI/15,8	3 830 CI/15,5	5 420 CI/16	7 870 CI/15,5	10 760 CI/16	15 750 CI/16	21 560 CI/15,8	25 660 CI/16,3	32 000 CI/16,3	41 080 CI/16			
	14	-	-	-	-	-	-	-	2 760 CI/14,2	4 310 CI/14,2	5 720 CI/14,7	8 820 CI/14,2	11 270 CI/14,7	17 630 CI/14,1	21 730 CI/14,2	28 270 CI/14,2	33 540 CI/14,2	44 070 CI/14,5			
12,5	130 CI/12,4	235 CI/12,6	300 CI/12,6	525 CI/13,1	605 CI/13,1	1 030 CI/12,4	2 140 CI/12,6	2 570 CI/12,9	4 560 CI/13	5 230 CI/13,1	9 110 CI/13	10 100 CI/12,8	17 640 CI/12,6	20 230 CI/12,9	27 360 CI/12,8	33 500 CI/12,8	39 370 CI/12,6				

For n_1 lower than 560 min⁻¹ see page 195.

9 - Selection tables (bevel helical gear reducers)

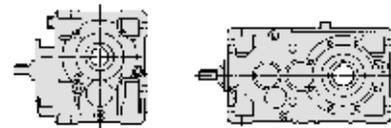

$n_{N2} \cdot L_h$ min ⁻¹ · h	i_N	P_{N2} kW M_{N2} N m ... / i																i_N	n_1 min ⁻¹	n_{N2} min ⁻¹	
		50	63	64	80	81	100	125	140	160	180	200	225	250	280	320	321				360
7 100 000	11,2	-	-	-	-	-	-	3 000 CI/11,3	4 090 CI/11,4	6 370 CI/11,7	8 080 CI/11,3	12 640 CI/11,7	16 370 CI/11,4	24 370 CI/11,3	28 290 CI/11	35 370 CI/11	46 200 CI/11,5				
	10	130 CI/10,3	260 CI/10	320 CI/10	550 CI/10,4	635 CI/10,4	1 120 CI/9,81	2 230 CI/10	2 880 CI/10,2	4 490 CI/10,3	5 860 CI/10,4	8 960 CI/10,3	11 330 CI/10,2	17 880 CI/10	22 690 CI/10,2	31 840 CI/10,2	38 990 CI/10,2	43 850 CI/10			
	9	-	-	-	-	-	-	3 030 CI/9	4 570 CI/9,04	6 290 CI/9,33	9 020 CI/8,93	12 370 CI/9,33	18 260 CI/9,04	23 870 CI/9	31 230 CI/8,75	38 890 CI/8,75	47 170 CI/9,2				
	8	140 CI/7,85	255 CI/8	325 CI/8	560 CI/8,33	650 CI/8,33	1 120 CI/7,85	2 260 CI/8	2 780 CI/8,15	4 520 CI/8,27	5 670 CI/8,31	9 020 CI/8,27	10 930 CI/8,14	16 810 CI/8,21	21 900 CI/8,15	28 310 CI/7,83	35 260 CI/7,83	42 620 CI/8			
	6,3	120 CI/6,53	215 CI/6,57	275 CI/6,57	465 CI/6,27	520 CI/6,27	960 CI/6,53	2 050 CI/6,57	-	3 850 CI/6,27	-	8 020 CI/6,53	-	16 140 CI/6,57	-	27 480 CI/6,27	34 350 CI/6,27	-			
	5	-	-	-	-	-	-	93,9 1 620 CI/5,06	-	185 3 090 CI/4,89▲	-	6 460 CI/5,11	-	12 780 CI/5,06	-	22 050 CI/4,89	27 570 CI/4,89	-	5	2800	560
	4	-	-	-	-	-	-	-	-	-	-	304 5 310 CI/4,1▲	-	10 380 CI/4	-	18 090 CI/3,9	22 610 CI/3,9	-	4	2240	
6 300 000	28	-	-	-	-	-	-	2 890 C21/28,6	4 430 C21/28,9	6 130 C21/28,8	8 720 C21/29,5	12 260 C21/30,3	17 690 C21/29,9	24 180 C21/30,1	30 650 C21/28	38 140 C21/28	48 360 C21/28,8				
	25	-	-	-	-	-	-	2 780 C21/24,5	4 400 C21/25,1	5 790 C21/26	8 950 C21/27	12 380 C21/26,3	17 970 C21/27,2	24 820 C21/26,4	31 460 C21/25,1	39 150 C21/25,1	49 640 C21/26				
	25	100 CI/24,1	200 CI/25	250 CI/25	400 CI/26	465 CI/26	760 CI/24,1	1 660 CI/25	-	3 290 CI/24,6	-	6 580 CI/24,6	-	13 460 CI/25,4	-	-	-				
	22,4	-	-	-	-	-	-	3 020 C21/23,8	4 480 C21/23,8	6 410 C21/23,7	9 100 C21/22,4	12 680 C21/23	18 300 C21/23,6	25 260 C21/23,8	32 030 C21/23	39 870 C21/23	50 530 C21/23,7				
	20	-	-	-	-	-	-	2 710 C21/20,4	4 600 C21/20,6	6 040 C21/21,4	9 330 C21/20,5	11 260 C21/19,9	18 760 C21/21,5	23 190 C21/20,8	32 840 C21/20,6	40 770 C21/20,6	47 570 C21/21,4				
	20	105 CI/19,3	195 CI/20	240 CI/20	420 CI/20,8	495 CI/20,8	870 CI/19,3	1 730 CI/20	2 490 CI/20	3 770 CI/19,7	4 980 CI/20,3	7 750 CI/19,7	9 960 CI/20,3	15 510 CI/20,3	19 670 CI/20	25 430 CI/19,7	30 370 CI/19,7	38 800 CI/20,3			
	18	-	-	-	-	-	-	2 590 CI/18	4 080 CI/18	5 370 CI/18,7	8 120 CI/18	10 640 CI/18,7	16 150 CI/17,9	20 550 CI/18	24 840 CI/18	31 360 CI/18	41 660 CI/18,4				
	16	110 CI/15,2	210 CI/15,8	255 CI/15,8	440 CI/16,4	515 CI/16,4	910 CI/15,2	1 810 CI/15,8	2 640 CI/15,8	3 960 CI/15,5	5 590 CI/16	8 130 CI/15,5	11 110 CI/16	16 260 CI/16	22 260 CI/15,8	26 490 CI/16,3	33 040 CI/16,3	42 410 CI/16			
	14	-	-	-	-	-	-	2 830 CI/14,2	4 430 CI/14,2	5 880 CI/14,7	9 060 CI/14,2	11 580 CI/14,7	18 110 CI/14,1	22 320 CI/14,2	29 040 CI/14,2	34 460 CI/14,2	45 280 CI/14,5				
	12,5	130 CI/12,4	245 CI/12,6	305 CI/12,6	540 CI/13,1	625 CI/13,1	1 060 CI/12,4	2 200 CI/12,6	2 640 CI/12,9	4 680 CI/13	5 370 CI/13,1	9 360 CI/13	10 370 CI/12,8	18 110 CI/12,6	20 760 CI/12,9	28 080 CI/12,8	34 380 CI/12,8	40 420 CI/12,6			
	11,2	-	-	-	-	-	-	-	3 080 CI/11,3	4 200 CI/11,4	6 550 CI/11,7	8 310 CI/11,3	12 980 CI/11,7	16 810 CI/11,4	25 040 CI/11,3	29 070 CI/11	36 330 CI/11	47 460 CI/11,5			

For n_1 lower than 560 min⁻¹ see page 195.

▲ Possible forced lubrication with heat exchanger: consult us.

9 - Selection tables (bevel helical gear reducers)

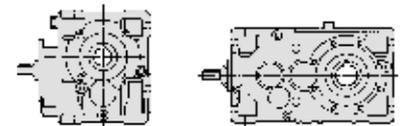

$n_{N2} \cdot L_h$ min ⁻¹ · h	i_N	P_{N2} kW																i_N	n_1 min ⁻¹	n_{N2} min ⁻¹		
		M_{N2} N m																				
		... / i																				
		50	63	64	80	81	100	125	140	160	180	200	225	250	280	320	321	360				
6 300 000	10	130 CI/10,3	265 CI/10	320 CI/10	555 CI/10,4	645 CI/10,4	1 130 CI/9,81	2 260 CI/10	2 920 CI/10,2	4 550 CI/10,3	5 940 CI/10,4	9 080 CI/10,3	11 480 CI/10,2	18 130 CI/10	22 990 CI/10,2	32 270 CI/10,2	39 520 CI/10,2	44 450 CI/10				
	9	-	-	-	-	-	-	-	3 070 CI/9	4 620 CI/9,04	6 370 CI/9,33	9 130 CI/8,93	12 530 CI/9,33	18 490 CI/9,04	24 170 CI/9	31 630 CI/8,75	39 380 CI/8,75	47 760 CI/9,2				
	8	140 CI/7,85	260 CI/8	330 CI/8	570 CI/8,33	655 CI/8,33	1 140 CI/7,85	2 290 CI/8	2 820 CI/8,15	4 580 CI/8,27	5 750 CI/8,31	9 150 CI/8,27	11 090 CI/8,14	17 040 CI/8,21	22 210 CI/8,15	28 710 CI/7,83	35 760 CI/7,83	43 230 CI/8				
	6,3	125 CI/6,53	220 CI/6,57	280 CI/6,57	475 CI/6,27	530 CI/6,27	975 CI/6,53	2 080 CI/6,57	-	3 900 CI/6,27	-	8 140 CI/6,53	-	16 370 CI/6,57	-	27 870 CI/6,27	34 840 CI/6,27	-				
	5	-	-	-	-	-	-	85 1 640 CI/5,06	-	168 3 130 CI/4,89	-	-	6 540 CI/5,11	-	12 950 CI/5,06	-	22 350 CI/4,89	27 940 CI/4,89	-	5	2500	500
	4	-	-	-	-	-	-	-	-	-	-	-	275 5 380 CI/4,1	-	10 520 CI/4	-	18 340 CI/3,9	22 920 CI/3,9	-	4	2000	
5 600 000	31,5	-	-	-	-	-	-	-	2 810 C2I/32	5 060 C2I/33,1	5 960 C2I/33,2	9 280 C2I/34,2	11 920 C2I/33,7	19 570 C2I/33,1	23 500 C2I/33,7	30 650 C2I/31,3	38 140 C2I/31,3	48 360 C2I/32,5				
	31,5	125 ICI/32,1	185 ICI/33	220 ICI/33	410 ICI/31,4	450 ICI/31,4	865 ICI/32,8	1 750 ICI/32,4	-	3 700 ICI/31,4	-	7 600 ICI/32,7	-	-	-	-	-	-				
	31,5	-	175 CI/31,3	205 CI/31,3	355 CI/32,5	435 CI/32,5	665 CI/30,1	1 330 CI/31,3	-	2 630 CI/30,8	-	4 600 CI/30,8	-	9 490 CI/31,7	-	-	-	-				
	28	-	-	-	-	-	-	-	2 970 C2I/28,6	4 580 C2I/28,9	6 290 C2I/28,8	8 950 C2I/29,5	12 580 C2I/30,3	18 300 C2I/29,9	24 820 C2I/30,1	31 460 C2I/28	39 150 C2I/28	49 640 C2I/28,8				
	25	-	-	-	-	-	-	-	2 860 C2I/24,5	4 530 C2I/25,1	5 950 C2I/26	9 190 C2I/27	12 720 C2I/26,3	18 460 C2I/27,2	25 500 C2I/26,4	32 320 C2I/25,1	40 230 C2I/25,1	51 000 C2I/26				
	25	105 CI/24,1	205 CI/25	255 CI/25	410 CI/26	480 CI/26	780 CI/24,1	1 710 CI/25	-	3 380 CI/24,6	-	6 760 CI/24,6	-	13 830 CI/25,4	-	-	-	-				
	22,4	-	-	-	-	-	-	-	3 100 C2I/23,8	4 600 C2I/23,8	6 570 C2I/23,7	9 330 C2I/22,4	13 000 C2I/23	18 760 C2I/23,6	25 900 C2I/23,8	32 840 C2I/23	40 890 C2I/23	51 810 C2I/23,7				
	20	-	-	-	-	-	-	-	2 780 C2I/20,4	4 730 C2I/20,6	6 210 C2I/21,4	9 590 C2I/20,5	11 580 C2I/19,9	19 300 C2I/21,5	23 850 C2I/20,8	33 780 C2I/20,6	41 930 C2I/20,6	48 930 C2I/21,4				
	20	110 CI/19,3	200 CI/20	250 CI/20	435 CI/20,8	510 CI/20,8	890 CI/19,3	1 780 CI/20	2 560 CI/20	3 880 CI/19,7	5 120 CI/20,3	7 980 CI/19,7	10 240 CI/20,3	15 950 CI/20,3	20 230 CI/20	26 150 CI/19,7	31 230 CI/19,7	39 910 CI/20,3				
	18	-	-	-	-	-	-	-	2 670 CI/18	4 210 CI/18	5 540 CI/18,7	8 380 CI/18	10 980 CI/18,7	16 670 CI/17,9	21 210 CI/18	25 640 CI/18	32 380 CI/18	43 010 CI/18,4				
	16	115 CI/15,2	215 CI/15,8	260 CI/15,8	455 CI/16,4	535 CI/16,4	935 CI/15,2	1 860 CI/15,8	2 710 CI/15,8	4 060 CI/15,5	5 740 CI/16	8 350 CI/15,5	11 420 CI/16	16 700 CI/16	22 870 CI/15,8	27 220 CI/16,3	33 940 CI/16,3	43 570 CI/16				
	14	-	-	-	-	-	-	-	2 910 CI/14,2	4 550 CI/14,2	6 040 CI/14,7	9 300 CI/14,2	11 880 CI/14,7	18 600 CI/14,1	22 920 CI/14,2	29 810 CI/14,2	35 370 CI/14,2	46 480 CI/14,5				

For n_1 lower than 560 min⁻¹ see page 195.

9 - Selection tables (bevel helical gear reducers)

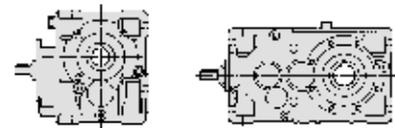

$n_{N2} \cdot L_h$ min ⁻¹ · h	i_N	P_{N2} kW																	i_N	n_1	n_{N2}
		M_{N2} N m																			
		... / i																			
		50	63	64	80	81	100	125	140	160	180	200	225	250	280	320	321	360			
5 600 000	12,5	135 CI/12,4	250 CI/12,6	315 CI/12,6	555 CI/13,1	640 CI/13,1	1 090 CI/12,4	2 260 CI/12,6	2 710 CI/12,9	4 810 CI/13	5 520 CI/13,1	9 610 CI/13	10 650 CI/12,8	18 600 CI/12,6	21 330 CI/12,9	28 850 CI/12,8	35 330 CI/12,8	41 530 CI/12,6			
	11,2	-	-	-	-	-	-	-	3 120 CI/11,3	4 260 CI/11,4	6 640 CI/11,7	8 420 CI/11,3	13 160 CI/11,7	17 040 CI/11,4	25 380 CI/11,3	29 460 CI/11	36 830 CI/11	48 110 CI/11,5			
	10	130 CI/10,3	265 CI/10	325 CI/10	565 CI/10,4	650 CI/10,4	1 150 CI/9,81	2 290 CI/10	2 950 CI/10,2	4 610 CI/10,3	6 020 CI/10,4	9 190 CI/10,3	11 630 CI/10,2	18 360 CI/10	23 290 CI/10,2	32 680 CI/10,2	40 020 CI/10,2	45 010 CI/10			
	9	-	-	-	-	-	-	-	3 110 CI/9	4 690 CI/9,04	6 460 CI/9,33	9 260 CI/8,93	12 710 CI/9,33	18 750 CI/9,04	24 510 CI/9	32 070 CI/8,75	39 940 CI/8,75	48 440 CI/9,2			
	8	140 CI/7,85	265 CI/8	335 CI/8	575 CI/8,33	665 CI/8,33	1 150 CI/7,85	2 330 CI/8	2 860 CI/8,15	4 650 CI/8,27	5 830 CI/8,31	9 280 CI/8,27	11 250 CI/8,14	17 290 CI/8,21	22 520 CI/8,15	29 130 CI/7,83	36 270 CI/7,83	43 850 CI/8			
	6,3	5,62 125 CI/6,53	9,92 220 CI/6,57	12,6 280 CI/6,57	22,5 480 CI/6,27	25,1 535 CI/6,27	44,3 985 CI/6,53	93,9 2 100 CI/6,57	-	185 3 960 CI/6,27 ▲	-	8 250 CI/6,53	-	16 600 CI/6,57	-	28 270 CI/6,27	35 330 CI/6,27	-	6,3	2800	450
	5	-	-	-	-	-	-	77,1 1 660 CI/5,06	-	152 3 170 CI/4,89	-	304 6 630 CI/5,11 ▲	-	13 120 CI/5,06	-	22 650 CI/4,89	28 310 CI/4,89	-	5	2240	
	4	-	-	-	-	-	-	-	-	-	-	251 5 450 CI/4,1	-	502 10 650 CI/4 ▲	-	18 570 CI/3,9	23 210 CI/3,9	-	4	1800	
5 000 000	35,5	-	-	-	-	-	-	2 890 C21/37,5	4 290 C21/37,5	6 130 C21/37,3	8 720 C21/35,3	12 020 C21/36,2	17 500 C21/37,2	24 180 C21/37,5	30 650 C21/36,3	38 140 C21/36,3	48 360 C21/37,3				
	31,5	-	-	-	-	-	-	2 880 C21/32	5 240 C21/33,1	6 120 C21/33,2	9 600 C21/34,2	12 240 C21/33,7	20 240 C21/33,1	24 120 C21/33,7	31 460 C21/31,3	39 150 C21/31,3	49 640 C21/32,5				
	31,5	130 ICI/32,1	190 ICI/33	225 ICI/33	425 ICI/31,4	465 ICI/31,4	885 ICI/32,8	1 800 ICI/32,4	-	3 800 ICI/31,4	-	7 800 ICI/32,7	-	-	-	-	-	-			
	31,5	-	180 CI/31,3	205 CI/31,3	365 CI/32,5	450 CI/32,5	690 CI/30,1	1 380 CI/31,3	-	2 720 CI/30,8	-	4 720 CI/30,8	-	9 740 CI/31,7	-	-	-	-			
	28	-	-	-	-	-	-	-	3 050 C21/28,6	4 730 C21/28,9	6 460 C21/28,8	9 190 C21/29,5	12 930 C21/30,3	18 910 C21/29,9	25 500 C21/30,1	32 320 C21/28	40 230 C21/28	51 000 C21/28,8			
	25	-	-	-	-	-	-	-	2 930 C21/24,5	4 640 C21/25,1	6 100 C21/26	9 430 C21/27	13 040 C21/26,3	18 930 C21/27,2	26 150 C21/26,4	33 150 C21/25,1	41 250 C21/25,1	52 300 C21/26			
	25	105 CI/24,1	215 CI/25	265 CI/25	425 CI/26	495 CI/26	800 CI/24,1	1 750 CI/25	-	3 460 CI/24,6	-	6 930 CI/24,6	-	14 180 CI/25,4	-	-	-	-			
	22,4	-	-	-	-	-	-	-	3 190 C21/23,8	4 730 C21/23,8	6 760 C21/23,7	9 590 C21/22,4	13 370 C21/23	19 300 C21/23,6	26 640 C21/23,8	33 780 C21/23	42 050 C21/23	53 290 C21/23,7			
	20	-	-	-	-	-	-	-	2 870 C21/20,4	4 880 C21/20,6	6 410 C21/21,4	9 900 C21/20,5	11 960 C21/19,9	19 920 C21/21,5	24 630 C21/20,8	34 870 C21/20,6	43 290 C21/20,6	50 510 C21/21,4			
	20	110 CI/19,3	210 CI/20	255 CI/20	450 CI/20,8	530 CI/20,8	920 CI/19,3	1 840 CI/20	2 640 CI/20	4 010 CI/19,7	5 290 CI/20,3	8 230 CI/19,7	10 570 CI/20,3	16 470 CI/20,3	20 890 CI/20	27 000 CI/19,7	32 240 CI/19,7	41 200 CI/20,3			

For n_1 lower than 560 min⁻¹ see page 195.

▲ Possible forced lubrication with heat exchanger: consult us.

9 - Selection tables (bevel helical gear reducers)

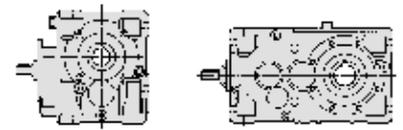

$n_{N2} \cdot L_h$ min ⁻¹ · h	i_N	P_{N2} kW																i_N	n_1 min ⁻¹	n_{N2} min ⁻¹	
		M_{N2} N m																			
		... / i																			
		50	63	64	80	81	100	125	140	160	180	200	225	250	280	320	321	360			
5 000 000	18	-	-	-	-	-	-	-	2 750 CI/18	4 320 CI/18	5 700 CI/18,7	8 610 CI/18	11 280 CI/18,7	17 130 CI/17,9	21 790 CI/18	26 350 CI/18	33 270 CI/18	44 190 CI/18,4			
	16	115 CI/15,2	220 CI/15,8	270 CI/15,8	470 CI/16,4	555 CI/16,4	960 CI/15,2	1 910 CI/15,8	2 780 CI/15,8	4 170 CI/15,5	5 900 CI/16	8 570 CI/15,5	11 720 CI/16	17 150 CI/16	23 480 CI/15,8	27 940 CI/16,3	34 850 CI/16,3	44 720 CI/16			
	14	-	-	-	-	-	-	-	2 990 CI/14,2	4 670 CI/14,2	6 200 CI/14,7	9 550 CI/14,2	12 210 CI/14,7	19 100 CI/14,1	23 540 CI/14,2	30 630 CI/14,2	36 340 CI/14,2	47 750 CI/14,5			
	12,5	140 CI/12,4	255 CI/12,6	320 CI/12,6	560 CI/13,1	650 CI/13,1	1 110 CI/12,4	2 290 CI/12,6	2 750 CI/12,9	4 870 CI/13	5 590 CI/13,1	9 740 CI/13	10 800 CI/12,8	18 860 CI/12,6	21 620 CI/12,9	29 250 CI/12,8	35 810 CI/12,8	42 090 CI/12,6			
	11,2	-	-	-	-	-	-	-	3 160 CI/11,3	4 310 CI/11,4	6 720 CI/11,7	8 520 CI/11,3	13 330 CI/11,7	17 260 CI/11,4	25 700 CI/11,3	29 840 CI/11	37 300 CI/11	48 720 CI/11,5			
	10	135 CI/10,3	270 CI/10	330 CI/10	570 CI/10,4	660 CI/10,4	1 160 CI/9,81	2 320 CI/10	3 000 CI/10,2	4 670 CI/10,3	6 110 CI/10,4	9 320 CI/10,3	11 790 CI/10,2	18 620 CI/10	23 620 CI/10,2	33 150 CI/10,2	40 590 CI/10,2	45 650 CI/10			
	9	-	-	-	-	-	-	-	3 160 CI/9	4 760 CI/9,04	6 550 CI/9,33	9 400 CI/8,93	12 890 CI/9,33	19 020 CI/9,04	24 860 CI/9	32 540 CI/8,75	40 520 CI/8,75	49 140 CI/9,2			
	8	145 CI/7,85	265 CI/8	340 CI/8	585 CI/8,33	675 CI/8,33	1 170 CI/7,85	2 360 CI/8	2 900 CI/8,15	4 710 CI/8,27	5 910 CI/8,31	9 410 CI/8,27	11 410 CI/8,14	17 540 CI/8,21	22 850 CI/8,15	29 550 CI/7,83	36 790 CI/7,83	44 480 CI/8			
	6,3	5,09 CI/6,53	8,98 CI/6,57	11,4 CI/6,57	20,3 CI/6,27	22,7 CI/6,27	40,1 CI/6,53	85 CI/6,57	168 CI/6,27	4 010 CI/6,27	-	8 360 CI/6,53	-	16 830 CI/6,57	-	28 650 CI/6,27	35 820 CI/6,27	-	6,3	2500	400
	5	-	-	-	-	-	-	69,8 CI/5,06	138 CI/4,89	3 210 CI/4,89	-	6 720 CI/5,11	-	13 300 CI/5,06	-	22 960 CI/4,89	28 700 CI/4,89	-	5	2000	
4	-	-	-	-	-	-	-	-	-	-	226 CI/4,1	5 530 CI/4,1	-	452 CI/4	10 800 CI/3,9	18 830 CI/3,9	23 540 CI/3,9	-	4	1600	
4 500 000	40	-	-	-	-	-	-	2 780 C2I/38,7	4 290 C2I/39,5	5 790 C2I/41	8 720 C2I/42,6	12 260 C2I/41,4	17 500 C2I/42,8	24 180 C2I/41,6	30 650 C2I/39,5	38 140 C2I/39,5	48 360 C2I/41				
	40	135 ICI/38,6	215 ICI/40,1	265 ICI/40,1	455 ICI/41,8	530 ICI/41,8	960 ICI/39,4	1 910 ICI/39,4	2 210 ICI/40,2	4 190 ICI/41,4	4 900 ICI/41,6	8 510 ICI/41,4	-	-	-	-	-	-			
	35,5	-	-	-	-	-	-	-	2 970 C2I/37,5	4 400 C2I/37,5	6 290 C2I/37,3	8 950 C2I/35,3	12 340 C2I/36,2	17 970 C2I/37,2	24 820 C2I/37,5	31 460 C2I/36,3	39 150 C2I/36,3	49 640 C2I/37,3			
	31,5	-	-	-	-	-	-	-	2 960 C2I/32	5 410 C2I/33,1	6 290 C2I/33,2	9 920 C2I/34,2	12 570 C2I/33,7	20 920 C2I/33,1	24 780 C2I/33,7	32 320 C2I/31,3	40 230 C2I/31,3	51 000 C2I/32,5			
	31,5	135 ICI/32,1	195 ICI/33	230 ICI/33	435 ICI/31,4	475 ICI/31,4	910 ICI/32,8	1 850 ICI/32,4	-	3 900 ICI/31,4	-	8 020 ICI/32,7	-	-	-	-	-	-			
	31,5	-	180 CI/31,3	210 CI/31,3	375 CI/32,5	460 CI/32,5	710 CI/30,1	1 420 CI/31,3	-	2 810 CI/30,8	-	4 850 CI/30,8	-	10 010 CI/31,7	-	-	-	-			
	28	-	-	-	-	-	-	-	3 130 C2I/28,6	4 900 C2I/28,9	6 630 C2I/28,8	9 430 C2I/29,5	13 260 C2I/30,3	19 560 C2I/29,9	26 150 C2I/30,1	33 150 C2I/28	41 250 C2I/28	52 300 C2I/28,8			

For n_1 lower than 560 min⁻¹ see page 195.

9 - Selection tables (bevel helical gear reducers)

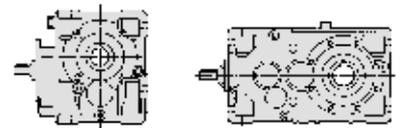

$n_{N2} \cdot L_h$ min ⁻¹ · h	i_N	P_{N2} kW																i_N	n_1 min ⁻¹	n_{N2} min ⁻¹	
		M_{N2} N m																			
		... / i																			
50	63	64	80	81	100	125	140	160	180	200	225	250	280	320	321	360					
4 000 000	40	140 ICI/38,6	220 ICI/40,1	275 ICI/40,1	470 ICI/41,8	540 ICI/41,8	990 ICI/39,4	1 960 ICI/39,4	2 270 ICI/40,2	4 300 ICI/41,4	5 030 ICI/41,6	8 740 ICI/41,4	-	-	-	-	-				
	35,5	-	-	-	-	-	-	-	3 050 C2I/37,5	4 530 C2I/37,5	6 460 C2I/37,3	9 190 C2I/35,3	12 680 C2I/36,2	18 460 C2I/37,2	25 500 C2I/37,5	32 320 C2I/36,3	40 230 C2I/36,3	51 000 C2I/37,3			
	31,5	-	-	-	-	-	-	-	3 030 C2I/32	5 600 C2I/33,1	6 450 C2I/33,2	10 270 C2I/34,2	12 890 C2I/33,7	21 650 C2I/33,1	25 410 C2I/33,7	33 150 C2I/31,3	41 250 C2I/31,3	52 300 C2I/32,5			
	31,5	135 ICI/32,1	200 ICI/33	240 ICI/33	445 ICI/31,4	490 ICI/31,4	935 ICI/32,8	1 890 ICI/32,4	-	4 000 ICI/31,4	-	8 220 ICI/32,7	-	-	-	-	-	-			
	31,5	-	185 CI/31,3	220 CI/31,3	385 CI/32,5	475 CI/32,5	735 CI/30,1	1 470 CI/31,3	-	2 910 CI/30,8	-	4 980 CI/30,8	-	10 260 CI/31,7	-	-	-	-			
	28	-	-	-	-	-	-	-	3 220 C2I/28,6	5 050 C2I/28,9	6 820 C2I/28,8	9 700 C2I/29,5	13 640 C2I/30,3	20 190 C2I/29,9	26 890 C2I/30,1	34 090 C2I/28	42 420 C2I/28	53 790 C2I/28,8			
	25	-	-	-	-	-	-	-	3 120 C2I/24,5	4 930 C2I/25,1	6 480 C2I/26	10 010 C2I/27	13 840 C2I/26,3	20 100 C2I/27,2	27 760 C2I/26,4	35 190 C2I/25,1	43 800 C2I/25,1	55 530 C2I/26			
	25	115 CI/24,1	225 CI/25	280 CI/25	450 CI/26	530 CI/26	850 CI/24,1	1 860 CI/25	-	3 680 CI/24,6	-	7 360 CI/24,6	-	15 060 CI/25,4	-	-	-	-			
	22,4	-	-	-	-	-	-	-	3 380 C2I/23,8	5 020 C2I/23,8	7 170 C2I/23,7	10 180 C2I/22,4	14 180 C2I/23	20 470 C2I/23,6	28 250 C2I/23,8	35 830 C2I/23	44 600 C2I/23	56 520 C2I/23,7			
	20	-	-	-	-	-	-	-	3 030 C2I/20,4	5 150 C2I/20,6	6 760 C2I/21,4	10 450 C2I/20,5	12 610 C2I/19,9	21 010 C2I/21,5	25 970 C2I/20,8	36 780 C2I/20,6	45 650 C2I/20,6	53 270 C2I/21,4			
	20	115 CI/19,3	220 CI/20	275 CI/20	485 CI/20,8	570 CI/20,8	970 CI/19,3	1 940 CI/20	2 790 CI/20	4 220 CI/19,7	5 580 CI/20,3	8 680 CI/19,7	11 150 CI/20,3	17 370 CI/20,3	22 030 CI/20	28 470 CI/19,7	34 010 CI/19,7	43 450 CI/20,3			
	18	-	-	-	-	-	-	-	2 900 CI/18	4 560 CI/18	6 010 CI/18,7	9 080 CI/18	11 900 CI/18,7	18 070 CI/17,9	22 980 CI/18	27 790 CI/18	35 080 CI/18	46 610 CI/18,4			
	16	120 CI/15,2	230 CI/15,8	280 CI/15,8	500 CI/16,4	590 CI/16,4	1000 CI/15,2	1 990 CI/15,8	2 900 CI/15,8	4 340 CI/15,5	6 140 CI/16	8 930 CI/15,5	12 200 CI/16	17 860 CI/16	24 450 CI/15,8	29 100 CI/16,3	36 290 CI/16,3	46 580 CI/16			
	14	-	-	-	-	-	-	-	3 070 CI/14,2	4 800 CI/14,2	6 370 CI/14,7	9 810 CI/14,2	12 530 CI/14,7	19 610 CI/14,1	24 170 CI/14,2	31 440 CI/14,2	37 300 CI/14,2	49 020 CI/14,5			
	12,5	140 CI/12,4	260 CI/12,6	330 CI/12,6	575 CI/13,1	665 CI/13,1	1 140 CI/12,4	2 350 CI/12,6	2 820 CI/12,9	5 000 CI/13	5 750 CI/13,1	10 010 CI/13	11 090 CI/12,8	19 370 CI/12,6	22 210 CI/12,9	30 040 CI/12,8	36 770 CI/12,8	43 230 CI/12,6			
	11,2	-	-	-	-	-	-	-	3 260 CI/11,3	4 440 CI/11,4	6 910 CI/11,7	8 770 CI/11,3	13 710 CI/11,7	17 760 CI/11,4	26 440 CI/11,3	30 690 CI/11	38 370 CI/11	50 120 CI/11,5			
	10	140 CI/10,3	280 CI/10	340 CI/10	590 CI/10,4	680 CI/10,4	1 200 CI/9,81	2 390 CI/10	3 080 CI/10,2	4 810 CI/10,3	6 280 CI/10,4	9 590 CI/10,3	12 130 CI/10,2	19 160 CI/10	24 300 CI/10,2	34 100 CI/10,2	41 760 CI/10,2	46 970 CI/10			
	9	-	-	-	-	-	-	-	106 CI/9	159 CI/9,04	212 CI/9,33▲	317 CI/8,93▲	-	-	-	-	-	-	9	2800	315

For n_1 lower than 560 min⁻¹ see page 195.

▲ Possible forced lubrication with heat exchanger: consult us.

9 - Selection tables (bevel helical gear reducers)

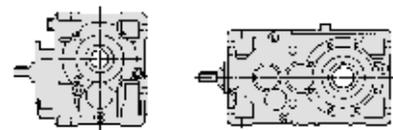

$n_{N2} \cdot L_h$ min ⁻¹ · h	i_N	P_{N2} kW																i_N	n_1	n_{N2} min ⁻¹	
		M_{N2} N m																			
		... / i																			
		50	63	64	80	81	100	125	140	160	180	200	225	250	280	320	321	360			
4 000 000	8	4,93 150 CI/7,85	8,98 275 CI/8	11,4 345 CI/8	18,9 600 CI/8,33	21,8 695 CI/8,33	40,1 1 200 CI/7,85	79,4 2 430 CI/8	95,8 2 980 CI/8,15	153 4 850 CI/8,27	192 6 080 CI/8,31	— 9 680 CI/8,27	— 11 730 CI/8,14	— 18 030 CI/8,21	— 23 490 CI/8,15	— 30 370 CI/7,83	— 37 820 CI/7,83	— 45 720 CI/8	8	2500	315
	6,3	4,18 130 CI/6,53	7,38 230 CI/6,57	9,34 295 CI/6,57	16,7 500 CI/6,27	18,7 560 CI/6,27	32,9 1 030 CI/6,53	69,8 2 190 CI/6,57	— 4 120 CI/6,27	138 — —	— 8 590 CI/6,53	275 — —	— 17 280 CI/6,57	— — —	— 29 430 CI/6,27	— 36 780 CI/6,27	— — —	6,3	2000		
	5	—	—	—	—	—	—	57,4 1 730 CI/5,06	— 3 300 CI/4,89	— — —	113 — —	226 6 900 CI/5,11	— — —	452 13 660 CI/5,06	— — —	— 23 580 CI/4,89	— 29 470 CI/4,89	— — —	5	1600	
	4	—	—	—	—	—	—	—	—	—	—	181 5 680 CI/4,1	— — —	363 11 090 CI/4	— — —	648 19 320 CI/3,9	810 24 150 CI/3,9	— — —	4	1250	
3 550 000	50	—	—	—	—	—	—	2 810 C2I/50,4	4 830 C2I/52,1	5 960 C2I/52,4	10 060 C2I/53,9	11 920 C2I/53,1	18 020 C2I/52,1	23 500 C2I/53,1	29 760 C2I/51,3	36 100 C2I/51,3	46 990 C2I/50,5				
	50	135 ICI/49	225 ICI/50,9	280 ICI/50,9	425 ICI/53	480 ICI/53	945 ICI/49,9	1 910 ICI/50	2 420 ICI/49,3	4 190 ICI/52,5	5 110 ICI/50,8	8 460 ICI/52,5	—	—	—	—	—	—			
	45	—	—	—	—	—	—	—	2 970 C2I/45,1	4 400 C2I/45,6	6 290 C2I/45,4	8 990 C2I/46,6	12 580 C2I/47,8	17 970 C2I/47,1	24 820 C2I/47,5	31 460 C2I/44,2	39 150 C2I/44,2	49 640 C2I/45,4			
	40	—	—	—	—	—	—	—	2 930 C2I/38,7	4 530 C2I/39,5	6 100 C2I/41	9 190 C2I/42,6	12 930 C2I/41,4	18 460 C2I/42,8	25 500 C2I/41,6	32 320 C2I/39,5	40 230 C2I/39,5	51 000 C2I/41			
	40	145 ICI/38,6	225 ICI/40,1	280 ICI/40,1	480 ICI/41,8	555 ICI/41,8	1 020 ICI/39,4	2 010 ICI/39,4	2 330 ICI/40,2	4 420 ICI/41,4	5 170 ICI/41,6	8 980 ICI/41,4	—	—	—	—	—	—			
	35,5	—	—	—	—	—	—	—	3 130 C2I/37,5	4 640 C2I/37,5	6 630 C2I/37,3	9 430 C2I/35,3	13 000 C2I/36,2	18 930 C2I/37,2	26 150 C2I/37,5	33 150 C2I/36,3	41 250 C2I/36,3	52 300 C2I/37,3			
	31,5	—	—	—	—	—	—	—	3 120 C2I/32	5 780 C2I/33,1	6 630 C2I/33,2	10 600 C2I/34,2	13 260 C2I/33,7	22 340 C2I/33,1	26 140 C2I/33,7	34 090 C2I/31,3	42 420 C2I/31,3	53 790 C2I/32,5			
	31,5	140 ICI/32,1	205 ICI/33	245 ICI/33	460 ICI/31,4	505 ICI/31,4	960 ICI/32,8	1 950 ICI/32,4	—	4 110 ICI/31,4	—	8 460 ICI/32,7	—	—	—	—	—	—			
	31,5	—	190 CI/31,3	225 CI/31,3	400 CI/32,5	485 CI/32,5	760 CI/30,1	1 520 CI/31,3	—	3 000 CI/30,8	—	5 120 CI/30,8	—	10 550 CI/31,7	—	—	—	—			
	28	—	—	—	—	—	—	—	3 320 C2I/28,6	5 240 C2I/28,9	7 040 C2I/28,8	10 010 C2I/29,5	14 080 C2I/30,3	20 920 C2I/29,9	27 760 C2I/30,1	35 190 C2I/28	43 800 C2I/28	55 530 C2I/28,8			
	25	—	—	—	—	—	—	—	3 200 C2I/24,5	5 060 C2I/25,1	6 660 C2I/26	10 290 C2I/27	14 220 C2I/26,3	20 650 C2I/27,2	28 530 C2I/26,4	36 160 C2I/25,1	45 000 C2I/25,1	57 050 C2I/26			
	25	120 CI/24,1	225 CI/25	285 CI/25	470 CI/26	550 CI/26	875 CI/24,1	1 910 CI/25	—	3 780 CI/24,6	—	7 560 CI/24,6	—	15 470 CI/25,4	—	—	—	—			
22,4	—	—	—	—	—	—	—	3 470 C2I/23,8	5 150 C2I/23,8	7 360 C2I/23,7	10 450 C2I/22,4	14 560 C2I/23	21 010 C2I/23,6	29 000 C2I/23,8	36 780 C2I/23	45 790 C2I/23	58 020 C2I/23,7				
20	—	—	—	—	—	—	—	3 110 C2I/20,4	5 290 C2I/20,6	6 950 C2I/21,4	10 730 C2I/20,5	12 960 C2I/19,9	21 590 C2I/21,5	26 680 C2I/20,8	37 790 C2I/20,6	46 900 C2I/20,6	54 730 C2I/21,4				

For n_1 lower than 560 min⁻¹ see page 195.

9 - Selection tables (bevel helical gear reducers)

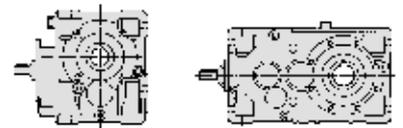

$n_{N2} \cdot L_h$ min ⁻¹ · h	i_N	P_{N2} kW																i_N	n_1 min ⁻¹	n_{N2} min ⁻¹		
		M_{N2} N m																				
		... / i																				
		50	63	64	80	81	100	125	140	160	180	200	225	250	280	320	321	360				
3 550 000	20	120 CI/19,3	225 CI/20	285 CI/20	500 CI/20,8	590 CI/20,8	1000 CI/19,3	1 990 CI/20	2 870 CI/20	4 340 CI/19,7	5 730 CI/20,3	8 920 CI/19,7	11 460 CI/20,3	17 840 CI/20,3	22 630 CI/20	29 250 CI/19,7	34 940 CI/19,7	44 650 CI/20,3				
	18	-	-	-	-	-	-	-	2 940 CI/18	4 620 CI/18	6 090 CI/18,7	9 210 CI/18	12 060 CI/18,7	18 310 CI/17,9	23 300 CI/18	28 170 CI/18	35 560 CI/18	47 240 CI/18,4				
	16	125 CI/15,2	230 CI/15,8	285 CI/15,8	500 CI/16,4	590 CI/16,4	1 010 CI/15,2	2 020 CI/15,8	2 930 CI/15,8	4 400 CI/15,5	6 220 CI/16	9 040 CI/15,5	12 360 CI/16	18 080 CI/16	24 760 CI/15,8	29 470 CI/16,3	36 750 CI/16,3	47 170 CI/16				
	14	-	-	-	-	-	-	-	3 110 CI/14,2	4 860 CI/14,2	6 460 CI/14,7	9 940 CI/14,2	12 710 CI/14,7	19 890 CI/14,1	24 510 CI/14,2	31 880 CI/14,2	37 830 CI/14,2	49 710 CI/14,5				
	12,5	145 CI/12,4	265 CI/12,6	335 CI/12,6	585 CI/13,1	675 CI/13,1	1 150 CI/12,4	2 390 CI/12,6	2 860 CI/12,9	5 070 CI/13	5 830 CI/13,1	10 150 CI/13	11 250 CI/12,8	19 640 CI/12,6	22 520 CI/12,9	30 470 CI/12,8	37 300 CI/12,8	43 850 CI/12,6				
	11,2	-	-	-	-	-	-	-	3 300 CI/11,3	4 500 CI/11,4	7 010 CI/11,7	8 900 CI/11,3	13 910 CI/11,7	18 010 CI/11,4	26 820 CI/11,3	31 130 CI/11	38 920 CI/11	50 840 CI/11,5				
	10	3,98 140 CI/10,3	8,28 280 CI/10	10,1 345 CI/10	16,8 595 CI/10,4	19,4 690 CI/10,4	36,2 1 210 CI/9,81	71,1 2 420 CI/10	89,9 3 130 CI/10,2	138 4 880 CI/10,3	180 6 370 CI/10,4	276 9 730 CI/10,3▲	354 12 300 CI/10,2▲	-	-	-	-	-	10	2800	280	
	9	-	-	-	-	-	-	-	95,8 3 290 CI/9	144 4 960 CI/9,04	192 6 830 CI/9,33	287 9 800 CI/9,93	-	13 440 CI/9,33	19 840 CI/9,04	25 920 CI/9	33 930 CI/8,75	42 250 CI/8,75	51 240 CI/9,2	9	2500	
	8	4,48 150 CI/7,85	8,15 280 CI/8	10,3 350 CI/8	17,1 610 CI/8,33	19,8 705 CI/8,33	36,4 1 220 CI/7,85	72,1 2 460 CI/8	86,9 3 020 CI/8,15	139 4 910 CI/8,27	174 6 160 CI/8,31	278 9 800 CI/8,27▲	342 11 880 CI/8,14▲	522 18 270 CI/8,21▲	-	-	-	-	8	2240		
	6,3	3,81 130 CI/6,53	6,72 235 CI/6,57	8,51 295 CI/6,57	15,2 505 CI/6,27	17 565 CI/6,27	30 1 040 CI/6,53	63,6 2 220 CI/6,57	-	125 4 170 CI/6,27	-	251 8 700 CI/6,53	-	502 17 500 CI/6,57▲	-	29 800 CI/6,27	37 250 CI/6,27	-	6,3	1800		
	5	-	-	-	-	-	-	51 1 760 CI/5,06	-	101 3 350 CI/4,89	-	201 7 010 CI/5,11	-	402 13 880 CI/5,06	-	718 23 960 CI/4,89▲	898 29 940 CI/4,89▲	-	5	1400		
	4	-	-	-	-	-	-	-	-	-	-	164 5 730 CI/4,1	-	328 11 200 CI/4	-	586 19 510 CI/3,9	732 24 380 CI/3,9	-	4	1120		
3 150 000	56	-	-	-	-	-	-	2 890 C21/55,4	5 280 C21/57	5 840 C21/56,8	10 340 C21/55,5	12 260 C21/56,9	19 400 C21/56,1	24 180 C21/56,6	30 650 C21/56	38 140 C21/56	48 360 C21/57,6					
	50	-	-	-	-	-	-	2 880 C21/50,4	4 990 C21/52,1	6 120 C21/52,4	10 400 C21/53,9	12 240 C21/53,1	18 640 C21/52,1	24 120 C21/53,1	30 550 C21/51,3	37 050 C21/51,3	48 240 C21/50,5					
	50	140 ICI/49	230 ICI/50,9	290 ICI/50,9	440 ICI/53	495 ICI/53	980 ICI/49,9	1 960 ICI/50	2 480 ICI/49,3	4 300 ICI/52,5	5 240 ICI/50,8	8 750 ICI/52,5	-	-	-	-	-					
	45	-	-	-	-	-	-	3 050 C21/45,1	4 530 C21/45,6	6 460 C21/45,4	9 290 C21/46,6	12 930 C21/47,8	18 460 C21/47,1	25 500 C21/47,5	32 320 C21/44,2	40 230 C21/44,2	51 000 C21/45,4					
	40	-	-	-	-	-	-	3 010 C21/38,7	4 640 C21/39,5	6 260 C21/41	9 430 C21/42,6	13 260 C21/41,4	18 930 C21/42,8	26 150 C21/41,6	33 150 C21/39,5	41 250 C21/39,5	52 300 C21/41					
	40	150 ICI/38,6	235 ICI/40,1	290 ICI/40,1	495 ICI/41,8	570 ICI/41,8	1 060 ICI/39,4	2 060 ICI/39,4	2 390 ICI/40,2	4 530 ICI/41,4	5 300 ICI/41,6	9 210 ICI/41,4	-	-	-	-	-					

For n_1 lower than 560 min⁻¹ see page 195.

▲ Possible forced lubrication with heat exchanger: consult us.

9 - Selection tables (bevel helical gear reducers)

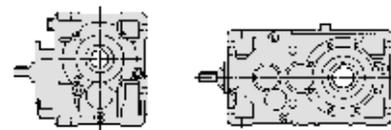

$n_{N2} \cdot L_h$ min ⁻¹ · h	i_N	P_{N2} kW M_{N2} N m ... / i																i_N	n_1 min ⁻¹	n_{N2} min ⁻¹		
		50	63	64	80	81	100	125	140	160	180	200	225	250	280	320	321				360	
		3 150 000	35,5	-	-	-	-	-	-	3 220 C2I/37,5	4 770 C2I/37,5	6 820 C2I/37,3	9 700 C2I/35,3	13 370 C2I/36,2	19 470 C2I/37,2	26 890 C2I/37,5	34 090 C2I/36,3				42 420 C2I/36,3	53 790 C2I/37,3
	31,5	-	-	-	-	-	-	3 220 C2I/32	5 990 C2I/33,1	6 840 C2I/33,2	10 980 C2I/34,2	13 690 C2I/33,7	23 150 C2I/33,1	26 980 C2I/33,7	35 190 C2I/31,3	43 800 C2I/31,3	55 530 C2I/32,5					
	31,5	145 CI/32,1	210 CI/33	255 CI/33	475 CI/31,4	520 CI/31,4	990 CI/32,8	2 010 CI/32,4	-	4 250 CI/31,4	-	8 730 CI/32,7	-	-	-	-	-					
	31,5	-	200 CI/31,3	235 CI/31,3	410 CI/32,5	500 CI/32,5	785 CI/30,1	1 570 CI/31,3	-	3 110 CI/30,8	-	5 280 CI/30,8	-	10 900 CI/31,7	-	-	-					
	28	-	-	-	-	-	-	3 410 C2I/28,6	5 430 C2I/28,9	7 230 C2I/28,8	10 290 C2I/29,5	14 460 C2I/30,3	21 680 C2I/29,9	28 530 C2I/30,1	36 160 C2I/28	45 000 C2I/28	57 050 C2I/28,8					
	25	-	-	-	-	-	-	3 290 C2I/24,5	5 200 C2I/25,1	6 830 C2I/26	10 560 C2I/27	14 600 C2I/26,3	21 200 C2I/27,2	29 280 C2I/26,4	37 120 C2I/25,1	46 190 C2I/25,1	58 560 C2I/26					
	25	120 CI/24,1	225 CI/25	285 CI/25	485 CI/26	570 CI/26	895 CI/24,1	1 960 CI/25	-	3 880 CI/24,6	-	7 760 CI/24,6	-	15 880 CI/25,4	-	-	-					
	22,4	-	-	-	-	-	-	3 570 C2I/23,8	5 290 C2I/23,8	7 560 C2I/23,7	10 730 C2I/22,4	14 960 C2I/23	21 590 C2I/23,6	29 800 C2I/23,8	37 790 C2I/23	47 040 C2I/23	59 610 C2I/23,7					
	20	-	-	-	-	-	-	3 160 C2I/20,4	5 360 C2I/20,6	7 040 C2I/21,4	10 880 C2I/20,5	13 130 C2I/19,9	21 880 C2I/21,5	27 050 C2I/20,8	38 300 C2I/20,6	47 540 C2I/20,6	55 480 C2I/21,4					
	20	125 CI/19,3	230 CI/20	285 CI/20	505 CI/20,8	590 CI/20,8	1 010 CI/19,3	2 020 CI/20	2 900 CI/20	4 400 CI/19,7	5 810 CI/20,3	9 040 CI/19,7	11 610 CI/20,3	18 090 CI/20,3	22 940 CI/20	29 650 CI/19,7	35 410 CI/19,7	45 250 CI/20,3				
	18	-	-	-	-	-	-	2 970 CI/18	4 680 CI/18	6 170 CI/18,7	9 320 CI/18	12 210 CI/18,7	18 540 CI/17,9	23 590 CI/18	28 520 CI/18	36 010 CI/18	47 840 CI/18,4					
	16	125 CI/15,2	235 CI/15,8	290 CI/15,8	505 CI/16,4	590 CI/16,4	1 030 CI/15,2	2 050 CI/15,8	2 980 CI/15,8	4 460 CI/15,5	6 310 CI/16	9 170 CI/15,5	12 530 CI/16	18 340 CI/16	25 110 CI/15,8	29 880 CI/16,3	37 270 CI/16,3	47 830 CI/16				
	14	-	-	-	-	-	-	3 160 CI/14,2	4 930 CI/14,2	6 550 CI/14,7	10 090 CI/14,2	12 890 CI/14,7	20 170 CI/14,1	24 860 CI/14,2	32 340 CI/14,2	38 380 CI/14,2	50 430 CI/14,5					
	12,5	145 CI/12,4	265 CI/12,6	340 CI/12,6	590 CI/13,1	685 CI/13,1	1 170 CI/12,4	2 420 CI/12,6	2 900 CI/12,9	5 150 CI/13	5 910 CI/13,1	10 300 CI/13	11 410 CI/12,8	19 930 CI/12,6	22 850 CI/12,9	30 910 CI/12,8	37 840 CI/12,8	44 480 CI/12,6				
	11,2	-	-	-	-	-	-	87,3 3 350 CI/11,3	117 4 570 CI/11,4	179 7 110 CI/11,7	235 9 020 CI/11,3	354 14 100 CI/11,7▲	-	-	-	-	-	11,2	2800	250		
	10	3,61 140 CI/10,3	7,49 285 CI/10	9,16 350 CI/10	15,2 605 CI/10,4	17,6 700 CI/10,4	32,8 1 230 CI/9,81	64,3 2 460 CI/10	81,4 3 170 CI/10,2	125 4 940 CI/10,3	163 6 460 CI/10,4	250 9 860 CI/10,3	321 12 470 CI/10,2	-	19 690 CI/10	24 980 CI/10,2	35 060 CI/10,2	42 930 CI/10,2	48 280 CI/10	10	2500	
	9	-	-	-	-	-	-	86,9 3 340 CI/9	130 5 020 CI/9,04	174 6 920 CI/9,33	261 9 930 CI/9,93	342 13 620 CI/9,33▲	522 20 100 CI/9,04▲	-	26 270 CI/9	34 370 CI/8,75	42 810 CI/8,75	51 910 CI/9,2	9	2240		
	8	4,05 150 CI/7,85	7,38 280 CI/8	9,34 355 CI/8	15,5 615 CI/8,33	17,9 715 CI/8,33	32,9 1 230 CI/7,85	65,3 2 490 CI/8	78,7 3 060 CI/8,15	126 4 980 CI/8,27	157 6 240 CI/8,31	252 9 940 CI/8,27	310 12 040 CI/8,14	472 18 510 CI/8,21	-	24 120 CI/8,15	31 190 CI/7,83	38 840 CI/7,83	46 960 CI/8	8	2000	

For n_1 lower than 560 min⁻¹ see page 195.

▲ Possible forced lubrication with heat exchanger: consult us.

9 - Selection tables (bevel helical gear reducers)

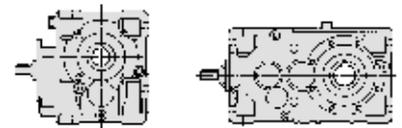

$n_{N2} \cdot L_h$ min ⁻¹ · h	i_N	P_{N2} kW																i_N	n_1 min ⁻¹	n_{N2} min ⁻¹	
		M_{N2} N m																			
		... / i																			
		50	63	64	80	81	100	125	140	160	180	200	225	250	280	320	321	360			
3 150 000	6,3	3,43 135 CI/6,53	6,06 240 CI/6,57	7,68 300 CI/6,57	13,7 515 CI/6,27	15,4 575 CI/6,27	27,1 1 060 CI/6,53	57,4 2 250 CI/6,57	-	113 4 230 CI/6,27	-	226 8 820 CI/6,53	-	452 17 750 CI/6,57	-	- 30 220 CI/6,27	- 37 780 CI/6,27	-	6,3	1600	250
	5	-	-	-	-	-	-	46 1 780 CI/5,06	-	90,9 3 390 CI/4,89	-	181 7 080 CI/5,11	-	363 14 020 CI/5,06	-	648 24 190 CI/4,89	810 30 240 CI/4,89	-	5	1250	
	4	-	-	-	-	-	-	-	-	-	-	148 5 790 CI/4,1	-	296 11 310 CI/4	-	528 19 700 CI/3,9	660 24 620 CI/3,9	-	4	1000	
2 800 000	63	-	-	-	-	-	-	2 810 C2I/62	5 150 C2I/65,2	6 740 C2I/65,5	10 300 C2I/64,2	11 920 C2I/63,2	20 600 C2I/62,1	23 500 C2I/63,3	32 540 C2I/65,1	40 680 C2I/65,1	46 990 C2I/64				
	63	120 ICI/60,1	230 ICI/63,6	280 ICI/63,6	475 ICI/66,2	560 ICI/66,2	1000 ICI/61,3	1 850 ICI/62,5	2 420 ICI/62,5	4 370 ICI/62,5	5 110 ICI/64,4	9 000 ICI/62,5	-	-	-	-	-				
	56	-	-	-	-	-	-	2 970 C2I/55,4	5 460 C2I/57	6 040 C2I/56,8	10 700 C2I/55,5	12 580 C2I/56,9	20 070 C2I/56,1	24 820 C2I/56,6	31 460 C2I/56	39 150 C2I/56	49 640 C2I/57,6				
	50	-	-	-	-	-	-	2 960 C2I/50,4	5 160 C2I/52,1	6 290 C2I/52,4	10 750 C2I/53,9	12 570 C2I/53,1	19 270 C2I/52,1	24 780 C2I/53,1	31 390 C2I/51,3	38 070 C2I/51,3	49 560 C2I/50,5				
	50	145 ICI/49	240 ICI/50,9	300 ICI/50,9	450 ICI/53	510 ICI/53	1 010 ICI/49,9	2 010 ICI/50	2 550 ICI/49,3	4 420 ICI/52,5	5 390 ICI/50,8	9 040 ICI/52,5	-	-	-	-	-				
	45	-	-	-	-	-	-	3 130 C2I/45,1	4 670 C2I/45,6	6 630 C2I/45,4	9 610 C2I/46,6	13 260 C2I/47,8	18 930 C2I/47,1	26 150 C2I/47,5	33 150 C2I/44,2	41 250 C2I/44,2	52 300 C2I/45,4				
	40	-	-	-	-	-	-	3 090 C2I/38,7	4 770 C2I/39,5	6 440 C2I/41	9 700 C2I/42,6	13 640 C2I/41,4	19 470 C2I/42,8	26 890 C2I/41,6	34 090 C2I/39,5	42 420 C2I/39,5	53 790 C2I/41				
	40	155 ICI/38,6	240 ICI/40,1	300 ICI/40,1	510 ICI/41,8	585 ICI/41,8	1 090 ICI/39,4	2 120 ICI/39,4	2 460 ICI/40,2	4 660 ICI/41,4	5 450 ICI/41,6	9 470 ICI/41,4	-	-	-	-	-				
	35,5	-	-	-	-	-	-	3 320 C2I/37,5	4 930 C2I/37,5	7 040 C2I/37,3	10 010 C2I/35,3	13 800 C2I/36,2	20 100 C2I/37,2	27 760 C2I/37,5	35 190 C2I/36,3	43 800 C2I/36,3	55 530 C2I/37,3				
	31,5	-	-	-	-	-	-	3 310 C2I/32	6 000 C2I/33,1	7 030 C2I/33,2	11 380 C2I/34,2	14 060 C2I/33,7	23 990 C2I/33,1	27 720 C2I/33,7	36 160 C2I/31,3	45 000 C2I/31,3	57 050 C2I/32,5				
	31,5	150 ICI/32,1	220 ICI/33	265 ICI/33	485 ICI/31,4	535 ICI/31,4	1 020 ICI/32,8	2 070 ICI/32,4	-	4 360 ICI/31,4	-	8 970 ICI/32,7	-	-	-	-	-				
	31,5	-	205 CI/31,3	245 CI/31,3	425 CI/32,5	515 CI/32,5	815 CI/30,1	1 630 CI/31,3	-	3 230 CI/30,8	-	5 460 CI/30,8	-	11 190 CI/31,7	-	-	-				
	28	-	-	-	-	-	-	3 510 C2I/28,6	5 620 C2I/28,9	7 420 C2I/28,8	10 560 C2I/29,5	14 850 C2I/30,3	22 470 C2I/29,9	29 280 C2I/30,1	37 120 C2I/28	46 190 C2I/28	58 560 C2I/28,8				
	25	-	-	-	-	-	-	3 380 C2I/24,5	5 340 C2I/25,1	7 020 C2I/26	10 850 C2I/27	15 000 C2I/26,3	21 780 C2I/27,2	30 080 C2I/26,4	38 140 C2I/25,1	47 460 C2I/25,1	60 170 C2I/26				
	25	125 CI/24,1	230 CI/25	285 CI/25	505 CI/26	590 CI/26	920 CI/24,1	2 010 CI/25	-	3 990 CI/24,6	-	7 970 CI/24,6	-	16 320 CI/25,4	-	-	-				

For n_1 lower than 560 min⁻¹ see page 195.

9 - Selection tables (bevel helical gear reducers)

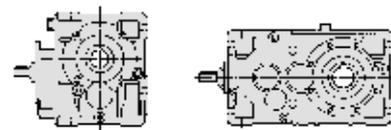

$n_{N2} \cdot L_h$ min ⁻¹ · h	i_N	P_{N2} kW M_{N2} N m ... / i																i_N	n_1 min ⁻¹	n_{N2} min ⁻¹		
		50	63	64	80	81	100	125	140	160	180	200	225	250	280	320	321				360	
2 800 000	22,4	-	-	-	-	-	-	-	3 610 C21/23,8	5 360 C21/23,8	7 660 C21/23,7	10 880 C21/22,4	15 160 C21/23	21 880 C21/23,6	30 200 C21/23,8	38 300 C21/23	47 680 C21/23	60 420 C21/23,7				
	20	-	-	-	-	-	-	-	3 200 C21/20,4	5 430 C21/20,6	7 130 C21/21,4	11 020 C21/20,5	13 300 C21/19,9	22 160 C21/21,5	27 390 C21/20,8	38 790 C21/20,6	48 150 C21/20,6	56 180 C21/21,4				
	20	125 CI/19,3	230 CI/20	285 CI/20	505 CI/20,8	595 CI/20,8	1 020 CI/19,3	2 040 CI/20	2 940 CI/20	4 460 CI/19,7	5 880 CI/20,3	9 160 CI/19,7	11 760 CI/20,3	18 310 CI/20,3	23 230 CI/20	30 030 CI/19,7	35 860 CI/19,7	45 830 CI/20,3				
	18	-	-	-	-	-	-	-	3 020 CI/18	4 750 CI/18	6 250 CI/18,7	9 450 CI/18	12 390 CI/18,7	18 810 CI/17,9	23 930 CI/18	28 930 CI/18	36 520 CI/18	48 520 CI/18,4				
	16	130 CI/15,2	235 CI/15,8	290 CI/15,8	505 CI/16,4	595 CI/16,4	1 040 CI/15,2	2 080 CI/15,8	3 020 CI/15,8	4 530 CI/15,5	6 400 CI/16	9 300 CI/15,5	12 710 CI/16	18 600 CI/16	25 470 CI/15,8	30 310 CI/16,3	37 800 CI/16,3	48 520 CI/16				
	14	-	-	-	-	-	-	-	3 200 CI/14,2	5 010 CI/14,2	6 640 CI/14,7	10 230 CI/14,2	13 080 CI/14,7	20 460 CI/14,1	25 220 CI/14,2	32 810 CI/14,2	38 930 CI/14,2	51 150 CI/14,5				
	12,5	3,5 CI/12,4	6,29 CI/12,6	7,97 CI/12,6	13,4 CI/13,1	15,5 CI/13,1	28,1 CI/12,4	57,1 CI/12,6	67,1 CI/12,9	117 CI/13	134 CI/13,1	235 CI/13	264 CI/12,8	- CI/12,6	- CI/12,9	- CI/12,8	- CI/12,8	- CI/12,6	12,5	2800	224	
	11,2	-	-	-	-	-	-	-	79 CI/11,3	106 CI/11,4	162 CI/11,7	213 CI/11,3	321 CI/11,7	414 CI/11,4	570 CI/11,3	770 CI/11,3	1010 CI/11	1320 CI/11	1710 CI/11,5	11,2	2500	
	10	3,27 CI/10,3	6,8 CI/10	8,31 CI/10	13,8 CI/10,4	16 CI/10,4	29,8 CI/9,81	58,4 CI/10	73,9 CI/10,2	114 CI/10,3	148 CI/10,4	227 CI/10,3	291 CI/10,2	468 CI/10,4	582 CI/10,2	- CI/10,2	- CI/10,2	- CI/10,2	10	2240		
	9	-	-	-	-	-	-	-	78,7 CI/9	118 CI/9,04	157 CI/9,33	236 CI/8,93	310 CI/9,33	472 CI/9,04	- CI/9	- CI/8,75	- CI/8,75	- CI/9,2	9	2000		
	8	3,69 CI/7,85	6,72 CI/8	8,51 CI/8	14,1 CI/8,33	16,4 CI/8,33	30 CI/7,85	59,5 CI/8	71,7 CI/8,15	115 CI/8,27	143 CI/8,31	229 CI/8,27	282 CI/8,14	430 CI/8,21	565 CI/8,15	760 CI/7,83	946 CI/7,83	- CI/8	8	1800		
	6,3	3,05 CI/6,53	5,39 CI/6,57	6,82 CI/6,57	12,2 CI/6,27	13,6 CI/6,27	24,1 CI/6,53	51 CI/6,57	- CI/6,27	101 CI/6,27	- CI/6,53	201 CI/6,53	- CI/6,53	402 CI/6,57	- CI/6,27	718 CI/6,27	898 CI/6,27	- CI/6,27	6,3	1400		
	5	-	-	-	-	-	-	41,6 CI/5,06	- CI/5,06	82,3 CI/4,89	- CI/4,89	164 CI/5,11	- CI/5,11	328 CI/5,06	- CI/5,06	586 CI/4,89	732 CI/4,89	- CI/4,89	5	1120		
	4	-	-	-	-	-	-	-	-	-	-	135 CI/4,1	- CI/4,1	269 CI/4	- CI/4	480 CI/3,9	600 CI/3,9	- CI/3,9	4	900		
2 500 000	71	-	-	-	-	-	-	2 890 C21/70,2	4 290 C21/72,3	5 640 C21/72	8 720 C21/70,3	12 260 C21/72,2	17 500 C21/71,2	24 180 C21/71,7	30 650 C21/71,1	38 140 C21/71,1	48 360 C21/73,1					
	63	-	-	-	-	-	-	2 880 C21/62	5 300 C21/65,2	6 970 C21/65,5	10 600 C21/64,2	12 240 C21/63,2	21 200 C21/62,1	24 120 C21/63,3	33 670 C21/65,1	42 080 C21/65,1	48 240 C21/64					
	63	125 ICI/60,1	230 ICI/63,6	285 ICI/63,6	495 ICI/66,2	580 ICI/66,2	1 030 ICI/61,3	1 910 ICI/62,5	2 480 ICI/62,5	4 500 ICI/62,5	5 240 ICI/64,4	9 250 ICI/62,5	-	-	-	-	-					
	56	-	-	-	-	-	-	3 050 C21/55,4	5 640 C21/57	6 240 C21/56,8	11 060 C21/55,5	12 930 C21/56,9	20 740 C21/56,1	25 500 C21/56,6	32 320 C21/56	40 230 C21/56	51 000 C21/57,6					

For n_1 lower than 560 min⁻¹ see page 195.

▲ Possible forced lubrication with heat exchanger: consult us.

9 - Selection tables (bevel helical gear reducers)

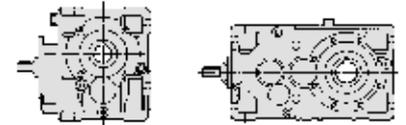

$n_{N2} \cdot L_h$ min ⁻¹ · h	i_N	P_{N2} kW																i_N	n_1 min ⁻¹	n_{N2} min ⁻¹			
		M_{N2} N m																					
		... / i																					
		50	63	64	80	81	100	125	140	160	180	200	225	250	280	320	321	360					
2 500 000	50	-	-	-	-	-	-	-	3 030 C2I/50,4	5 340 C2I/52,1	6 450 C2I/52,4	11 120 C2I/53,9	12 890 C2I/53,1	19 930 C2I/52,1	25 410 C2I/53,1	32 190 C2I/51,3	39 270 C2I/51,3	50 820 C2I/50,5					
	50	150 ICI/49	245 ICI/50,9	310 ICI/50,9	460 ICI/53	520 ICI/53	1 050 ICI/49,9	2 060 ICI/50	2 610 ICI/49,3	4 530 ICI/52,5	5 520 ICI/50,8	9 360 ICI/52,5	-	-	-	-	-	-	-	-	-	-	-
	45	-	-	-	-	-	-	-	3 220 C2I/45,1	4 820 C2I/45,6	6 820 C2I/45,4	9 920 C2I/46,6	13 640 C2I/47,8	19 470 C2I/47,1	26 890 C2I/47,5	34 090 C2I/44,2	42 420 C2I/44,2	53 790 C2I/45,4					
	40	-	-	-	-	-	-	-	3 200 C2I/38,7	4 930 C2I/39,5	6 650 C2I/41	10 010 C2I/42,6	14 080 C2I/41,4	20 100 C2I/42,8	27 760 C2I/41,6	35 190 C2I/39,5	43 800 C2I/39,5	55 530 C2I/41					
	40	155 ICI/38,6	250 ICI/40,1	310 ICI/40,1	525 ICI/41,8	605 ICI/41,8	1 130 ICI/39,4	2 190 ICI/39,4	2 540 ICI/40,2	4 810 ICI/41,4	5 630 ICI/41,6	9 780 ICI/41,4	-	-	-	-	-	-	-	-	-	-	-
	35,5	-	-	-	-	-	-	-	3 410 C2I/37,5	5 060 C2I/37,5	7 230 C2I/37,3	10 290 C2I/35,3	14 180 C2I/36,2	20 650 C2I/37,2	28 530 C2I/37,5	36 160 C2I/36,3	45 000 C2I/36,3	57 050 C2I/37,3					
	31,5	-	-	-	-	-	-	-	3 400 C2I/32	6 150 C2I/33,1	7 220 C2I/33,2	11 790 C2I/34,2	14 430 C2I/33,7	24 860 C2I/33,1	28 460 C2I/33,7	37 120 C2I/31,3	46 190 C2I/31,3	58 560 C2I/32,5					
	31,5	160 ICI/32,1	225 ICI/33	275 ICI/33	500 ICI/31,4	545 ICI/31,4	1 050 ICI/32,8	2 120 ICI/32,4	-	4 480 ICI/31,4	-	9 210 ICI/32,7	-	-	-	-	-	-	-	-	-	-	-
	31,5	-	210 CI/31,3	245 CI/31,3	445 CI/32,5	530 CI/32,5	845 CI/30,1	1 690 CI/31,3	-	3 340 CI/30,8	-	5 660 CI/30,8	-	11 490 CI/31,7	-	-	-	-	-	-	-	-	-
	28	-	-	-	-	-	-	-	3 600 C2I/28,6	5 830 C2I/28,9	7 630 C2I/28,8	10 850 C2I/29,5	15 250 C2I/30,3	23 280 C2I/29,9	30 080 C2I/30,1	38 140 C2I/28	47 460 C2I/28	60 170 C2I/28,8					
	25	-	-	-	-	-	-	-	3 420 C2I/24,5	5 410 C2I/25,1	7 120 C2I/26	11 000 C2I/27	15 210 C2I/26,3	22 080 C2I/27,2	30 490 C2I/26,4	38 660 C2I/25,1	48 100 C2I/25,1	60 990 C2I/26					
	25	130 CI/24,1	230 CI/25	285 CI/25	505 CI/26	595 CI/26	935 CI/24,1	2 040 CI/25	-	4 040 CI/24,6	-	8 080 CI/24,6	-	16 540 CI/25,4	-	-	-	-	-	-	-	-	-
	22,4	-	-	-	-	-	-	-	3 660 C2I/23,8	5 430 C2I/23,8	7 760 C2I/23,7	11 020 C2I/22,4	15 350 C2I/23	22 160 C2I/23,6	30 580 C2I/23,8	38 790 C2I/23	48 280 C2I/23	61 190 C2I/23,7					
	20	-	-	-	-	-	-	-	3 240 C2I/20,4	5 510 C2I/20,6	7 240 C2I/21,4	11 170 C2I/20,5	13 490 C2I/19,9	22 470 C2I/21,5	27 780 C2I/20,8	39 340 C2I/20,6	48 830 C2I/20,6	56 980 C2I/21,4					
	20	130 CI/19,3	235 CI/20	290 CI/20	505 CI/20,8	595 CI/20,8	1 040 CI/19,3	2 070 CI/20	2 980 CI/20	4 520 CI/19,7	5 960 CI/20,3	9 290 CI/19,7	11 930 CI/20,3	18 570 CI/20,3	23 560 CI/20	30 450 CI/19,7	36 370 CI/19,7	46 480 CI/20,3					
	18	-	-	-	-	-	-	-	3 060 CI/18	4 810 CI/18	6 340 CI/18,7	9 590 CI/18	12 560 CI/18,7	19 080 CI/17,9	24 270 CI/18	29 340 CI/18	37 050 CI/18	49 210 CI/18,4					
16	135 CI/15,2	240 CI/15,8	295 CI/15,8	510 CI/16,4	595 CI/16,4	1 060 CI/15,2	2 110 CI/15,8	3 060 CI/15,8	4 590 CI/15,5	6 490 CI/16	9 430 CI/15,5	12 900 CI/16	18 870 CI/16	25 830 CI/15,8	30 750 CI/16,3	38 350 CI/16,3	49 220 CI/16						
14	-	-	-	-	-	-	-	67,1	105	134	214	264	-	-	-	-	-	14	2800	200			

For n_1 lower than 560 min⁻¹ see page 195.

▲ Possible forced lubrication with heat exchanger: consult us.

9 - Selection tables (bevel helical gear reducers)

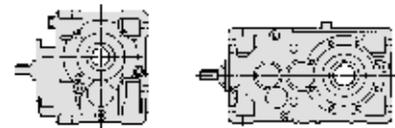

$n_{N2} \cdot L_h$ min ⁻¹ · h	i_N	P_{N2} kW																	i_N	n_1	n_{N2}
		M_{N2} N m																			
		... / i																			
		50	63	64	80	81	100	125	140	160	180	200	225	250	280	320	321	360			
2 500 000	12,5	3,17 150 CI/12,4	5,69 275 CI/12,6	7,21 345 CI/12,6	12,1 610 CI/13,1	14 705 CI/13,1	25,4 1 200 CI/12,4	51,7 2 490 CI/12,6	60,7 2 980 CI/12,9	106 5 290 CI/13	121 6 080 CI/13,1	213 10 580 CI/13	239 11 730 CI/12,8	- 20 480 CI/12,6	- 23 490 CI/12,9	- 31 770 CI/12,8	- 38 900 CI/12,8	- 45 720 CI/12,6	12,5	2500	200
	11,2	-	-	-	-	-	-	71,7 3 440 CI/11,3	96,5 4 690 CI/11,4	147 7 300 CI/11,7	193 9 270 CI/11,3	291 14 480 CI/11,7	386 18 760 CI/11,4	582 27 930 CI/11,3▲	- 32 430 CI/11	- 40 540 CI/11	- 52 950 CI/11,5	11,2	2240		
	10	2,96 145 CI/10,3	6,16 295 CI/10	7,52 360 CI/10	12,5 620 CI/10,4	14,5 720 CI/10,4	26,9 1 260 CI/9,81	52,9 2 520 CI/10	66,9 3 250 CI/10,2	103 5 080 CI/10,3	134 6 630 CI/10,4	205 10 130 CI/10,3	264 12 810 CI/10,2	424 20 220 CI/10	527 25 650 CI/10,2	- 36 010 CI/10,2	- 44 090 CI/10,2	- 49 590 CI/10	10	2000	
	9	-	-	-	-	-	-	71,7 3 420 CI/9	108 5 160 CI/9,04	143 7 100 CI/9,33	215 10 190 CI/8,93	282 13 980 CI/9,33	430 20 630 CI/9,04	565 26 960 CI/9▲	760 35 280 CI/8,75▲	946 43 940 CI/8,75▲	- 53 290 CI/9,2	9	1800		
	8	3,33 155 CI/7,85	6,06 290 CI/8	7,68 365 CI/8	12,7 635 CI/8,33	14,7 735 CI/8,33	27,1 1 270 CI/7,85	53,6 2 560 CI/8	64,6 3 150 CI/8,15	104 5 110 CI/8,27	129 6 410 CI/8,31	207 10 200 CI/8,27	255 12 370 CI/8,14	388 19 010 CI/8,21	509 24 770 CI/8,15	685 32 030 CI/7,83	853 39 890 CI/7,83	- 48 220 CI/8	8	1600	
	6,3	2,77 140 CI/6,53	4,84 245 CI/6,57	6,12 305 CI/6,57	11 525 CI/6,27	12,5 595 CI/6,27	21,6 1 080 CI/6,53	46 2 310 CI/6,57	-	90,9 4 350 CI/6,27	-	181 9 060 CI/6,53	-	363 18 220 CI/6,57	-	648 31 010 CI/6,27	810 38 760 CI/6,27	-	6,3	1250	
	5	-	-	-	-	-	-	37,6 1 810 CI/5,06	-	74,3 3 470 CI/4,89	-	148 7 230 CI/5,11	-	296 14 310 CI/5,06	-	528 24 660 CI/4,89	660 30 830 CI/4,89	-	5	1000	
	4	-	-	-	-	-	-	-	-	-	-	121 5 910 CI/4,1	-	242 11 540 CI/4	-	431 20 070 CI/3,9	538 25 090 CI/3,9	-	4	800	
	2 240 000	80	-	-	-	-	-	-	2 810 C2I/78,6	4 740 C2I/82,7	5 960 C2I/83,1	9 420 C2I/81,4	11 920 C2I/80,2	17 030 C2I/78,8	23 500 C2I/80,3	29 760 C2I/82,6	36 100 C2I/82,6	46 990 C2I/81,2			
		80	120 ICI/75,2	230 ICI/79,5	280 ICI/79,5	435 ICI/82,7	515 ICI/82,7	995 ICI/76,7	1 650 ICI/78,1	2 050 ICI/78,1	3 610 ICI/78,1	4 130 ICI/80,5	7 420 ICI/78,1	-	-	-	-	-			
71		-	-	-	-	-	-	2 970 C2I/70,2	4 400 C2I/72,3	5 790 C2I/72	8 950 C2I/70,3	12 580 C2I/72,2	17 970 C2I/71,2	24 820 C2I/71,7	31 460 C2I/71,1	39 150 C2I/71,1	49 640 C2I/73,1				
63		-	-	-	-	-	-	2 960 C2I/62	5 450 C2I/65,2	7 200 C2I/65,5	10 900 C2I/64,2	12 610 C2I/63,2	21 800 C2I/62,1	24 870 C2I/63,3	34 800 C2I/65,1	43 490 C2I/65,1	49 560 C2I/64				
63		130 ICI/60,1	230 ICI/63,6	285 ICI/63,6	510 ICI/66,2	600 ICI/66,2	1 060 ICI/61,3	1 980 ICI/62,5	2 550 ICI/62,5	4 620 ICI/62,5	5 390 ICI/64,4	9 500 ICI/62,5	-	-	-	-	-				
56		-	-	-	-	-	-	3 130 C2I/55,4	5 600 C2I/57	6 460 C2I/56,8	11 440 C2I/55,5	13 260 C2I/56,9	21 460 C2I/56,1	26 150 C2I/56,6	33 150 C2I/56	41 250 C2I/56	52 300 C2I/57,6				
50		-	-	-	-	-	-	3 120 C2I/50,4	5 510 C2I/52,1	6 630 C2I/52,4	11 480 C2I/53,9	13 260 C2I/53,1	20 570 C2I/52,1	26 140 C2I/53,1	33 110 C2I/51,3	40 530 C2I/51,3	52 270 C2I/50,5				
50		155 ICI/49	255 ICI/50,9	320 ICI/50,9	475 ICI/53	535 ICI/53	1 080 ICI/49,9	2 120 ICI/50	2 690 ICI/49,3	4 660 ICI/52,5	5 680 ICI/50,8	9 660 ICI/52,5	-	-	-	-	-				
45		-	-	-	-	-	-	3 320 C2I/45,1	4 990 C2I/45,6	7 040 C2I/45,4	10 280 C2I/46,6	14 080 C2I/47,8	20 100 C2I/47,1	27 760 C2I/47,5	35 190 C2I/44,2	43 800 C2I/44,2	55 530 C2I/45,4				
40	-	-	-	-	-	-	3 280 C2I/38,7	5 060 C2I/39,5	6 830 C2I/41	10 290 C2I/42,6	14 460 C2I/41,4	20 650 C2I/42,8	28 530 C2I/41,6	36 160 C2I/39,5	45 000 C2I/39,5	57 050 C2I/41					

For n_1 lower than 560 min⁻¹ see page 195.

▲ Possible forced lubrication with heat exchanger: consult us.

9 - Selection tables (bevel helical gear reducers)

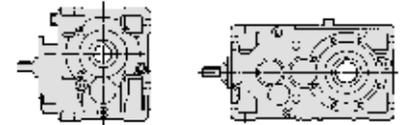

$n_{N2} \cdot L_h$ min ⁻¹ · h	i_N	P_{N2} kW																i_N	n_1	n_{N2} min ⁻¹	
		M_{N2} N m																			
		... / i																			
		50	63	64	80	81	100	125	140	160	180	200	225	250	280	320	321	360			
2 240 000	40	160 ICI/38,6	260 ICI/40,1	325 ICI/40,1	540 ICI/41,8	625 ICI/41,8	1 170 ICI/39,4	2 250 ICI/39,4	2 610 ICI/40,2	4 940 ICI/41,4	5 780 ICI/41,6	10 040 ICI/41,4	-	-	-	-	-	-			
	35,5	-	-	-	-	-	-	-	3 510 C2I/37,5	5 200 C2I/37,5	7 420 C2I/37,3	10 560 C2I/35,3	14 560 C2I/36,2	21 200 C2I/37,2	29 280 C2I/37,5	37 120 C2I/36,3	46 190 C2I/36,3	58 560 C2I/37,3			
	31,5	-	-	-	-	-	-	-	3 490 C2I/32	6 480 C2I/33,1	7 440 C2I/33,2	12 220 C2I/34,2	14 830 C2I/33,7	25 760 C2I/33,1	29 240 C2I/33,7	38 140 C2I/31,3	47 460 C2I/31,3	60 170 C2I/32,5			
	31,5	165 ICI/32,1	230 ICI/33	285 ICI/33	510 ICI/31,4	560 ICI/31,4	1 070 ICI/32,8	2 180 ICI/32,4	-	4 600 ICI/31,4	-	9 460 ICI/32,7	-	-	-	-	-	-			
	31,5	-	220 CI/31,3	245 CI/31,3	445 CI/32,5	555 CI/32,5	875 CI/30,1	1 750 CI/31,3	-	3 460 CI/30,8	-	5 870 CI/30,8	-	11 810 CI/31,7	-	-	-	-			
	28	-	-	-	-	-	-	-	3 650 C2I/28,6	6 030 C2I/28,9	7 730 C2I/28,8	11 000 C2I/29,5	15 460 C2I/30,3	24 090 C2I/29,9	30 490 C2I/30,1	38 660 C2I/28	48 100 C2I/28	60 990 C2I/28,8			
	25	-	-	-	-	-	-	-	3 470 C2I/24,5	5 480 C2I/25,1	7 210 C2I/26	11 130 C2I/27	15 400 C2I/26,3	22 590 C2I/27,2	30 880 C2I/26,4	39 140 C2I/25,1	48 710 C2I/25,1	61 760 C2I/26			
	25	135 CI/24,1	230 CI/25	285 CI/25	510 CI/26	600 CI/26	945 CI/24,1	2 070 CI/25	-	4 090 CI/24,6	-	8 180 CI/24,6	-	16 750 CI/25,4	-	-	-	-			
	22,4	-	-	-	-	-	-	-	3 710 C2I/23,8	5 510 C2I/23,8	7 870 C2I/23,7	11 170 C2I/22,4	15 570 C2I/23	22 470 C2I/23,6	31 020 C2I/23,8	39 340 C2I/23	48 970 C2I/23	62 060 C2I/23,7			
	20	-	-	-	-	-	-	-	3 290 C2I/20,4	5 590 C2I/20,6	7 340 C2I/21,4	11 330 C2I/20,5	13 680 C2I/19,9	22 790 C2I/21,5	28 180 C2I/20,8	39 900 C2I/20,6	49 530 C2I/20,6	57 790 C2I/21,4			
	20	135 CI/19,3	240 CI/20	295 CI/20	510 CI/20,8	600 CI/20,8	1 050 CI/19,3	2 100 CI/20	3 030 CI/20	4 580 CI/19,7	6 050 CI/20,3	9 420 CI/19,7	12 100 CI/20,3	18 840 CI/20,3	23 900 CI/20	30 890 CI/19,7	36 890 CI/19,7	47 140 CI/20,3			
	18	-	-	-	-	-	-	-	3 100 CI/18	4 880 CI/18	6 430 CI/18,7	9 730 CI/18	12 740 CI/18,7	19 350 CI/17,9	24 620 CI/18	29 760 CI/18	37 580 CI/18	49 920 CI/18,4			
	16	2,68 140 CI/15,2	4,54 245 CI/15,8	5,58 300 CI/15,8	9,29 520 CI/16,4	10,7 600 CI/16,4	20,7 1 070 CI/15,2	40,3 2 170 CI/15,8	57,7 3 110 CI/15,8	87,9 4 660 CI/15,5	121 6 580 CI/16	181 9 570 CI/15,5	240 13 080 CI/16	-	-	-	-	-	16	2800	180
	14	-	-	-	-	-	-	-	60,7 3 290 CI/14,2	94,9 5 150 CI/14,2	121 6 830 CI/14,7	194 10 520 CI/14,2	239 13 440 CI/14,7	-	-	-	-	-	14	2500	
	12,5	2,88 150 CI/12,4	5,17 280 CI/12,6	6,55 350 CI/12,6	11 615 CI/13,1	12,7 715 CI/13,1	23,1 1 220 CI/12,4	46,9 2 520 CI/12,6	55,1 3 020 CI/12,9	96,5 5 360 CI/13,1	110 6 160 CI/13,1	193 10 720 CI/13	217 11 880 CI/12,8	386 20 750 CI/12,6	434 23 800 CI/12,9	-	-	-	12,5	2240	
	11,2	-	-	-	-	-	-	-	64,9 3 490 CI/11,3	87,3 4 750 CI/11,4	133 7 400 CI/11,7	175 9 390 CI/11,3	264 14 680 CI/11,7	349 19 010 CI/11,4	527 28 320 CI/11,3	624 32 870 CI/11	780 41 090 CI/11	-	11,2	2000	
10	2,7 150 CI/10,3	5,61 300 CI/10	6,86 365 CI/10	11,4 630 CI/10,4	13,2 730 CI/10,4	24,6 1 280 CI/9,81	48,2 2 560 CI/10	60,9 3 300 CI/10,2	93,8 5 140 CI/10,3	122 6 720 CI/10,4	187 10 260 CI/10,3	240 12 970 CI/10,2	386 20 480 CI/10	480 25 980 CI/10,2	676 36 460 CI/10,2▲	828 44 650 CI/10,2▲	946 50 210 CI/10▲	10	1800		
9	-	-	-	-	-	-	-	64,6 3 470 CI/9	97 5 230 CI/9,04	129 7 200 CI/9,33	194 10 330 CI/8,93	255 14 180 CI/9,33	388 20 920 CI/9,04	509 27 340 CI/9	685 35 780 CI/8,75	853 44 560 CI/8,75	-	9	1600		

For n_1 lower than 560 min⁻¹ see page 195.

▲ Possible forced lubrication with heat exchanger: consult us.

9 - Selection tables (bevel helical gear reducers)

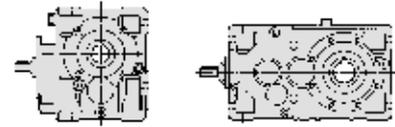

$n_{N2} \cdot L_h$ min ⁻¹ · h	i_N	P_{N2} kW																i_N	n_1	n_{N2}		
		M_{N2} N m																				
		... / i																				
		50	63	64	80	81	100	125	140	160	180	200	225	250	280	320	321	360				
2 240 000	8	2,96 160 CI/7,85	5,39 295 CI/8	6,82 370 CI/8	11,3 645 CI/8,33	13,1 745 CI/8,33	24,1 1 290 CI/7,85	47,7 2 600 CI/8	57,5 3 200 CI/8,15	92,1 5 190 CI/8,27	115 6 510 CI/8,31	184 10 370 CI/8,27	226 12 570 CI/8,14	345 19 320 CI/8,21	453 25 170 CI/8,15	609 32 550 CI/7,83	759 40 530 CI/7,83	898 49 000 CI/8▲	8	1400	180	
	6,3	2,57 145 CI/6,53	4,36 245 CI/6,57	5,51 310 CI/6,57	9,86 525 CI/6,27	11,5 615 CI/6,27	19,4 1 080 CI/6,53	41,6 2 330 CI/6,57	-	82,3 4 400 CI/6,27	-	164 9 150 CI/6,53	-	328 18 400 CI/6,57	-	586 31 310 CI/6,27	732 39 130 CI/6,27	-	6,3	1120		
	5	-	-	-	-	-	-	34,1 1 830 CI/5,06	-	67,6 3 510 CI/4,89	-	135 7 290 CI/5,11	-	269 14 440 CI/5,06	-	480 24 880 CI/4,89	600 31 100 CI/4,89	-	5	900		
	4	-	-	-	-	-	-	-	-	-	-	108 5 970 CI/4,1	-	217 11 650 CI/4	-	386 20 270 CI/3,9	482 25 340 CI/3,9	-	4	710		
2 000 000	90	-	-	-	-	-	-	2 890 C21/87,8	4 680 C21/90,4	5 710 C21/90	9 140 C21/87,9	12 260 C21/90,3	17 500 C21/89	24 180 C21/89,7	30 650 C21/88,8	38 140 C21/88,8	48 360 C21/91,4					
	80	-	-	-	-	-	-	2 880 C21/78,6	4 910 C21/82,7	6 120 C21/83,1	9 750 C21/81,4	12 240 C21/80,2	17 480 C21/78,8	24 120 C21/80,3	30 550 C21/82,6	37 050 C21/82,6	48 240 C21/81,2					
	80	125 ICI/75,2	230 ICI/79,5	290 ICI/79,5	450 ICI/82,7	530 ICI/82,7	1 030 ICI/76,7	1 700 ICI/78,1	2 110 ICI/78,1	3 710 ICI/78,1	4 270 ICI/80,5	7 620 ICI/78,1	-	-	-	-	-	-				
	71	-	-	-	-	-	-	3 050 C21/70,2	4 530 C21/72,3	5 950 C21/72	9 190 C21/70,3	12 930 C21/72,2	18 460 C21/71,2	25 500 C21/71,7	32 320 C21/71,1	40 230 C21/71,1	51 000 C21/73,1					
	63	-	-	-	-	-	-	3 030 C21/62	5 600 C21/65,2	7 450 C21/65,5	11 200 C21/64,2	13 050 C21/63,2	22 400 C21/62,1	25 730 C21/63,3	36 000 C21/65,1	45 000 C21/65,1	50 820 C21/64					
	63	130 ICI/60,1	230 ICI/63,6	290 ICI/63,6	510 ICI/66,2	600 ICI/66,2	1 090 ICI/61,3	2 050 ICI/62,5	2 610 ICI/62,5	4 750 ICI/62,5	5 520 ICI/64,4	9 750 ICI/62,5	-	-	-	-	-	-				
	56	-	-	-	-	-	-	3 220 C21/55,4	5 800 C21/57	6 660 C21/56,8	11 810 C21/55,5	13 640 C21/56,9	22 150 C21/56,1	26 890 C21/56,6	34 090 C21/56	42 420 C21/56	53 790 C21/57,6					
	50	-	-	-	-	-	-	3 220 C21/50,4	5 710 C21/52,1	6 840 C21/52,4	11 890 C21/53,9	13 690 C21/53,1	21 310 C21/52,1	26 980 C21/53,1	34 180 C21/51,3	41 990 C21/51,3	53 960 C21/50,5					
	50	155 ICI/49	265 ICI/50,9	330 ICI/50,9	490 ICI/53	555 ICI/53	1 120 ICI/49,9	2 190 ICI/50	2 780 ICI/49,3	4 810 ICI/52,5	5 870 ICI/50,8	10 000 ICI/52,5	-	-	-	-	-	-				
	45	-	-	-	-	-	-	3 410 C21/45,1	5 170 C21/45,6	7 230 C21/45,4	10 650 C21/46,6	14 460 C21/47,8	20 650 C21/47,1	28 530 C21/47,5	36 160 C21/44,2	45 000 C21/44,2	57 050 C21/45,4					
	40	-	-	-	-	-	-	3 370 C21/38,7	5 200 C21/39,5	7 010 C21/41	10 560 C21/42,6	14 850 C21/41,4	21 200 C21/42,8	29 280 C21/41,6	37 120 C21/39,5	46 190 C21/39,5	58 560 C21/41					
	40	165 ICI/38,6	270 ICI/40,1	335 ICI/40,1	555 ICI/41,8	640 ICI/41,8	1 220 ICI/39,4	2 310 ICI/39,4	2 680 ICI/40,2	5 070 ICI/41,4	5 940 ICI/41,6	10 310 ICI/41,4	-	-	-	-	-	-				
	35,5	-	-	-	-	-	-	3 600 C21/37,5	5 340 C21/37,5	7 630 C21/37,3	10 850 C21/35,3	14 960 C21/36,2	21 780 C21/37,2	30 080 C21/37,5	38 140 C21/36,3	47 460 C21/36,3	60 170 C21/37,3					
31,5	-	-	-	-	-	-	3 540 C21/32	6 500 C21/33,1	7 700 C21/33,2	12 640 C21/34,2	15 030 C21/33,7	25 900 C21/33,1	29 640 C21/33,7	38 660 C21/31,3	48 100 C21/31,3	60 990 C21/32,5						

For n_1 lower than 560 min⁻¹ see page 195.

9 - Selection tables (bevel helical gear reducers)

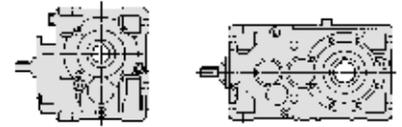

$n_{N2} \cdot L_h$ min ⁻¹ · h	i_N	P_{N2} kW																i_N	n_1	n_{N2} min ⁻¹		
		M_{N2} N m																				
		... / i																				
		50	63	64	80	81	100	125	140	160	180	200	225	250	280	320	321	360				
2 000 000	31,5	170 ICI/32,1	235 ICI/33	295 ICI/33	520 ICI/31,4	570 ICI/31,4	1 090 ICI/32,8	2 210 ICI/32,4	—	4 660 ICI/31,4	—	9 590 ICI/32,7	—	—	—	—	—	—				
	31,5	—	220 CI/31,3	245 CI/31,3	450 CI/32,5	560 CI/32,5	905 CI/30,1	1 810 CI/31,3	—	3 580 CI/30,8	—	6 070 CI/30,8	—	11 970 CI/31,7	—	—	—	—				
	28	—	—	—	—	—	—	—	3 700 C2I/28,6	6 220 C2I/28,9	7 830 C2I/28,8	11 270 C2I/29,5	15 660 C2I/30,3	24 860 C2I/29,9	30 880 C2I/30,1	39 140 C2I/28	48 710 C2I/28	61 760 C2I/28,8				
	25	—	—	—	—	—	—	—	3 510 C2I/24,5	5 590 C2I/25,1	7 310 C2I/26	11 290 C2I/27	15 620 C2I/26,3	23 410 C2I/27,2	31 320 C2I/26,4	39 700 C2I/25,1	49 400 C2I/25,1	62 640 C2I/26				
	25	140 CI/24,1	230 CI/25	290 CI/25	510 CI/26	600 CI/26	960 CI/24,1	2 100 CI/25	—	4 150 CI/24,6	—	8 300 CI/24,6	—	16 990 CI/25,4	—	—	—	—				
	22,4	—	—	—	—	—	—	—	3 770 C2I/23,8	5 590 C2I/23,8	7 980 C2I/23,7	11 330 C2I/22,4	15 790 C2I/23	22 790 C2I/23,6	31 460 C2I/23,8	39 900 C2I/23	49 670 C2I/23	62 950 C2I/23,7				
	20	—	—	—	—	—	—	—	3 340 C2I/20,4	5 670 C2I/20,6	7 440 C2I/21,4	11 490 C2I/20,5	13 880 C2I/19,9	23 120 C2I/21,5	28 580 C2I/20,8	40 470 C2I/20,6	50 240 C2I/20,6	58 620 C2I/21,4				
	20	140 CI/19,3	240 CI/20	300 CI/20	515 CI/20,8	600 CI/20,8	1 070 CI/19,3	2 130 CI/20	3 070 CI/20	4 650 CI/19,7	6 140 CI/20,3	9 560 CI/19,7	12 270 CI/20,3	19 110 CI/20,3	24 240 CI/20	31 330 CI/19,7	37 790 CI/19,7	47 820 CI/20,3				
	18	—	—	—	—	—	—	—	51,2 3 150 CI/18	80,7 4 950 CI/18	102 6 530 CI/18,7	161 9 870 CI/18	203 12 920 CI/18,7	—	—	—	—	—	18	2800	160	
	16	2,48 145 CI/15,2	4,11 250 CI/15,8	5,05 305 CI/15,8	8,41 525 CI/16,4	9,72 610 CI/16,4	18,7 1 090 CI/15,2	37,2 2 240 CI/15,8	52,3 3 150 CI/15,8	79,6 4 720 CI/15,5	109 6 670 CI/16	164 9 700 CI/15,5	217 13 260 CI/16	—	—	—	—	—	16	2500		
	14	—	—	—	—	—	—	—	55,1 3 340 CI/14,2	86,2 5 210 CI/14,2	110 6 920 CI/14,7	176 10 660 CI/14,2	217 13 620 CI/14,7	355 21 310 CI/14,1	434 26 270 CI/14,2	—	—	—	14	2240		
	12,5	2,61 155 CI/12,4	4,68 280 CI/12,6	5,92 355 CI/12,6	9,96 625 CI/13,1	11,5 725 CI/13,1	20,9 1 230 CI/12,4	42,4 2 560 CI/12,6	49,9 3 060 CI/12,9	87,3 5 430 CI/13	99,8 6 240 CI/13,1	175 10 870 CI/13	196 12 040 CI/12,8	349 21 040 CI/12,6	393 24 120 CI/12,9	533 32 630 CI/12,8	652 39 950 CI/12,8	780 46 960 CI/12,6	12,5	2000		
	11,2	—	—	—	—	—	—	—	59,1 3 530 CI/11,3	79,6 4 810 CI/11,4	121 7 500 CI/11,7	159 9 510 CI/11,3	240 14 870 CI/11,7	318 19 250 CI/11,4	480 28 670 CI/11,3	568 33 290 CI/11	710 41 610 CI/11	891 54 350 CI/11,5▲	11,2	1800		
	10	2,43 150 CI/10,3	5,06 300 CI/10	6,18 370 CI/10	10,3 640 CI/10,4	11,9 740 CI/10,4	22,1 1 300 CI/9,81	43,4 2 590 CI/10	54,9 3 340 CI/10,2	84,5 5 210 CI/10,3	110 6 810 CI/10,4	169 10 400 CI/10,3	217 13 160 CI/10,2	348 20 770 CI/10	433 26 350 CI/10,2	609 36 980 CI/10,2	746 45 280 CI/10,2	853 50 930 CI/10	10	1600		
	9	—	—	—	—	—	—	—	57,5 3 530 CI/9	86,2 5 310 CI/9,04	115 7 320 CI/9,33	172 10 500 CI/8,93	226 14 410 CI/9,33	345 21 260 CI/9,04	453 27 780 CI/9	609 36 360 CI/8,75	759 45 280 CI/8,75	875 54 910 CI/9,2▲	9	1400		
	8	2,65 160 CI/7,85	4,84 295 CI/8	6,11 375 CI/8	10,1 645 CI/8,33	11,7 750 CI/8,33	21,6 1 290 CI/7,85	42,8 2 620 CI/8	51,8 3 230 CI/8,15	83,1 5 250 CI/8,27	104 6 580 CI/8,31	166 10 470 CI/8,27	204 12 700 CI/8,14	311 19 510 CI/8,21	408 25 430 CI/8,15	549 32 850 CI/7,83	685 40 990 CI/7,83	810 49 490 CI/8	8	1250		
6,3	2,37 150 CI/6,53	3,91 245 CI/6,57	4,94 310 CI/6,57	8,85 530 CI/6,27	10,7 640 CI/6,27	17,4 1 090 CI/6,53	37,6 2 360 CI/6,57	—	74,3 4 450 CI/6,27	—	148 9 240 CI/6,53	—	296 18 580 CI/6,57	—	528 31 610 CI/6,27	660 39 510 CI/6,27	—	6,3	1000			
5	—	—	—	—	—	—	30,9 1 860 CI/5,06	—	60,8 3 550 CI/4,89	—	121 7 370 CI/5,11	—	242 14 590 CI/5,06	—	431 25 130 CI/4,89	538 31 410 CI/4,89	—	5	800			

For n_1 lower than 560 min⁻¹ see page 195.

9 - Selection tables (bevel helical gear reducers)

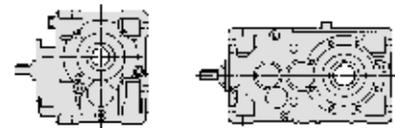

$n_{N2} \cdot L_h$ min ⁻¹ · h	i_N	P_{N2} kW M_{N2} N m ... / i																i_N	n_1 min ⁻¹	n_{N2} min ⁻¹	
		50	63	64	80	81	100	125	140	160	180	200	225	250	280	320	321				360
2 000 000	4	-	-	-	-	-	-	-	-	-	97,1 6 030 C1/4,1	-	194 11 770 C1/4	-	346 20 470 C1/3,9	432 25 590 C1/3,9	-	4	630	160	
1 800 000	100	-	-	-	-	-	-	2 810 C21/98,2	5 150 C21/103	5 970 C21/104	10 580 C21/102	11 920 C21/100	17 330 C21/98,5	23 500 C21/100	31 150 C21/103	38 930 C21/103	46 990 C21/102				
	100	-	190 IC1/99,4	235 IC1/99,4	410 IC1/103	460 IC1/103	1 110 IC1/100	1 940 IC1/102	2 420 IC1/100	4 930 IC1/106	5 800 IC1/102	10 300 IC1/106	-	-	-	-	-				
	90	-	-	-	-	-	-	2 970 C21/87,8	4 840 C21/90,4	5 860 C21/90	9 460 C21/87,9	12 580 C21/90,3	17 970 C21/89	24 820 C21/89,7	31 460 C21/88,8	39 150 C21/88,8	49 640 C21/91,4				
	80	-	-	-	-	-	-	2 960 C21/78,6	5 070 C21/82,7	6 290 C21/83,1	10 080 C21/81,4	12 570 C21/80,2	17 960 C21/78,8	24 780 C21/80,3	31 390 C21/82,6	38 070 C21/82,6	49 560 C21/81,2				
	80	130 IC1/75,2	230 IC1/79,5	290 IC1/79,5	465 IC1/82,7	550 IC1/82,7	1 060 IC1/76,7	1 750 IC1/78,1	2 160 IC1/78,1	3 810 IC1/78,1	4 410 IC1/80,5	7 830 IC1/78,1	-	-	-	-	-				
	71	-	-	-	-	-	-	3 130 C21/70,2	4 640 C21/72,3	6 100 C21/72	9 430 C21/70,3	13 260 C21/72,2	18 930 C21/71,2	26 150 C21/71,7	33 150 C21/71,1	41 250 C21/71,1	52 300 C21/73,1				
	63	-	-	-	-	-	-	3 120 C21/62	5 600 C21/65,2	7 690 C21/65,5	11 500 C21/64,2	13 460 C21/63,2	23 000 C21/62,1	26 550 C21/63,3	37 150 C21/65,1	46 440 C21/65,1	52 270 C21/64				
	63	135 IC1/60,1	230 IC1/63,6	290 IC1/63,6	510 IC1/66,2	605 IC1/66,2	1 120 IC1/61,3	2 110 IC1/62,5	2 690 IC1/62,5	4 870 IC1/62,5	5 680 IC1/64,4	10 000 IC1/62,5	-	-	-	-	-				
	56	-	-	-	-	-	-	3 320 C21/55,4	6 000 C21/57	6 900 C21/56,8	12 240 C21/55,5	14 080 C21/56,9	22 940 C21/56,1	27 760 C21/56,6	35 190 C21/56	43 800 C21/56	55 530 C21/57,6				
	50	-	-	-	-	-	-	3 310 C21/50,4	5 920 C21/52,1	7 030 C21/52,4	12 330 C21/53,9	14 060 C21/53,1	22 090 C21/52,1	27 720 C21/53,1	35 110 C21/51,3	43 520 C21/51,3	55 440 C21/50,5				
	50	155 IC1/49	275 IC1/50,9	330 IC1/50,9	505 IC1/53	570 IC1/53	1 160 IC1/49,9	2 250 IC1/50	2 850 IC1/49,3	4 940 IC1/52,5	6 030 IC1/50,8	10 370 IC1/52,5	-	-	-	-	-				
	45	-	-	-	-	-	-	3 510 C21/45,1	5 360 C21/45,6	7 420 C21/45,4	11 040 C21/46,6	14 850 C21/47,8	21 200 C21/47,1	29 280 C21/47,5	37 120 C21/44,2	46 190 C21/44,2	58 560 C21/45,4				
	40	-	-	-	-	-	-	3 460 C21/38,7	5 340 C21/39,5	7 200 C21/41	10 850 C21/42,6	15 250 C21/41,4	21 780 C21/42,8	30 080 C21/41,6	38 140 C21/39,5	47 460 C21/39,5	60 170 C21/41				
	40	170 IC1/38,6	280 IC1/40,1	345 IC1/40,1	570 IC1/41,8	655 IC1/41,8	1 260 IC1/39,4	2 370 IC1/39,4	2 750 IC1/40,2	5 210 IC1/41,4	6 100 IC1/41,6	10 590 IC1/41,4	-	-	-	-	-				
	35,5	-	-	-	-	-	-	3 650 C21/37,5	5 410 C21/37,5	7 730 C21/37,3	11 000 C21/35,3	15 160 C21/36,2	22 080 C21/37,2	30 490 C21/37,5	38 660 C21/36,3	48 100 C21/36,3	60 990 C21/37,3				
31,5	-	-	-	-	-	-	3 580 C21/32	6 520 C21/33,1	7 940 C21/33,2	12 950 C21/34,2	15 220 C21/33,7	25 990 C21/33,1	30 010 C21/33,7	39 140 C21/31,3	48 710 C21/31,3	61 760 C21/32,5					
31,5	170 IC1/32,1	245 IC1/33	305 IC1/33	525 IC1/31,4	575 IC1/31,4	1 120 IC1/32,8	2 240 IC1/32,4	-	4 720 IC1/31,4	-	9 710 IC1/32,7	-	-	-	-	-					

For n_1 lower than 560 min⁻¹ see page 195.

9 - Selection tables (bevel helical gear reducers)

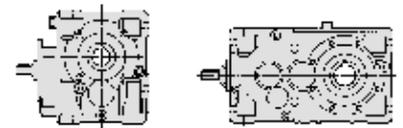

$n_{N2} \cdot L_h$ min ⁻¹ · h	i_N	P_{N2} kW																i_N	n_1 min ⁻¹	n_{N2} min ⁻¹		
		M_{N2} N m																				
		... / i																				
		50	63	64	80	81	100	125	140	160	180	200	225	250	280	320	321	360				
1 800 000	31,5	-	220 CI/31,3	245 CI/31,3	450 CI/32,5	560 CI/32,5	935 CI/30,1	1 870 CI/31,3	-	3 700 CI/30,8	-	6 260 CI/30,8	-	12 180 CI/31,7	-	-	-	-				
	28	-	-	-	-	-	-	-	3 750 C2I/28,6	6 450 C2I/28,9	7 940 C2I/28,8	11 680 C2I/29,5	15 880 C2I/30,3	25 750 C2I/29,9	31 320 C2I/30,1	39 700 C2I/28	49 400 C2I/28	62 640 C2I/28,8				
	25	-	-	-	-	-	-	-	3 560 C2I/24,5	5 790 C2I/25,1	7 410 C2I/26	11 450 C2I/27	15 840 C2I/26,3	24 260 C2I/27,2	31 770 C2I/26,4	40 270 C2I/25,1	50 110 C2I/25,1	63 530 C2I/26				
	25	145 CI/24,1	230 CI/25	290 CI/25	510 CI/26	605 CI/26	995 CI/24,1	2 130 CI/25	-	4 210 CI/24,6	-	8 420 CI/24,6	-	17 230 CI/25,4	-	-	-	-				
	22,4	-	-	-	-	-	-	-	3 820 C2I/23,8	5 690 C2I/23,8	8 090 C2I/23,7	11 490 C2I/22,4	16 020 C2I/23	23 120 C2I/23,6	31 920 C2I/23,8	40 470 C2I/23	50 380 C2I/23	63 850 C2I/23,7				
	20	-	-	-	-	-	-	-	48,6 3 380 C2I/20,4	81,8 5 750 C2I/20,6	104 7 550 C2I/21,4	167 11 660 C2I/20,5▲	207 14 070 C2I/19,9▲	-	23 450 C2I/20,8	-	41 050 C2I/20,6	-	59 450 C2I/21,4	20	2800	140
	20	2,22 145 CI/19,3	3,61 245 CI/20	4,43 300 CI/20	7,38 525 CI/20,8	8,53 605 CI/20,8	16,5 1 080 CI/19,3	31,7 2 160 CI/20	45,6 3 110 CI/20	70,2 4 710 CI/19,7	89,9 6 220 CI/20,3	144 9 690 CI/19,7	180 12 440 CI/20,3	-	19 380 CI/20,3	24 580 CI/20	31 780 CI/19,7	39 150 CI/19,7	48 500 CI/20,3	20	2800	
	18	-	-	-	-	-	-	-	46,4 3 190 CI/18	73 5 020 CI/18,7	92,8 6 610 CI/18,7	145 10 000 CI/18	184 13 100 CI/18,7	-	19 890 CI/17,9	25 310 CI/18	30 600 CI/18	38 630 CI/18	51 320 CI/18,4	18	2500	
	16	2,25 145 CI/15,2	3,73 250 CI/15,8	4,59 310 CI/15,8	7,63 535 CI/16,4	8,82 615 CI/16,4	17 1 100 CI/15,2	34,5 2 320 CI/15,8	47,4 3 190 CI/15,8	72,2 4 780 CI/15,5	99,1 6 760 CI/16	148 9 830 CI/15,5	197 13 430 CI/16	288 19 650 CI/16	400 26 910 CI/15,8	-	32 030 CI/16,3	39 940 CI/16,3	51 260 CI/16	16	2240	
	14	-	-	-	-	-	-	-	49,9 3 380 CI/14,2	78 5 280 CI/14,2	99,8 7 010 CI/14,7	159 10 800 CI/14,2	196 13 810 CI/14,7	321 21 600 CI/14,1	393 26 620 CI/14,2	511 34 630 CI/14,2	606 41 100 CI/14,2	780 54 000 CI/14,5	14	2000		
	12,5	2,37 155 CI/12,4	4,26 285 CI/12,6	5,4 360 CI/12,6	9,08 635 CI/13,1	10,5 735 CI/13,1	19 1 250 CI/12,4	38,7 2 590 CI/12,6	45,5 3 100 CI/12,9	79,6 5 500 CI/13	90,9 6 320 CI/13,1	159 11 010 CI/13	180 12 290 CI/12,8	318 21 300 CI/12,6	358 24 430 CI/12,9	486 33 040 CI/12,8	594 40 450 CI/12,8	710 47 550 CI/12,6	12,5	1800		
	11,2	-	-	-	-	-	-	-	53,3 3 580 CI/11,3	71,7 4 880 CI/11,4	109 7 600 CI/11,7	143 9 640 CI/11,3	217 15 080 CI/11,7	287 19 530 CI/11,4	433 29 080 CI/11,3	512 33 760 CI/11	640 42 200 CI/11	803 55 120 CI/11,5	11,2	1600		
	10	2,16 150 CI/10,3	4,5 305 CI/10	5,49 375 CI/10	9,12 650 CI/10,4	10,6 750 CI/10,4	19,7 1 320 CI/9,81	38,6 2 630 CI/10	48,8 3 400 CI/10,2	75,2 5 300 CI/10,3	97,7 6 920 CI/10,4	150 10 570 CI/10,3	193 13 370 CI/10,2	309 21 100 CI/10	385 26 770 CI/10,2	542 37 570 CI/10,2	663 46 010 CI/10,2	759 51 740 CI/10	10	1400		
	9	-	-	-	-	-	-	-	51,8 3 560 CI/9	77,8 5 370 CI/9,04	104 7 390 CI/9,33	155 10 600 CI/8,93	204 14 560 CI/9,33	311 21 460 CI/9,04	408 28 070 CI/9	549 36 700 CI/8,75	685 45 790 CI/8,75	789 55 470 CI/9,2	9	1250		
	8	2,38 160 CI/7,85	4,36 295 CI/8	5,49 375 CI/8	9,12 650 CI/8,33	10,6 750 CI/8,33	19,4 1 300 CI/7,85	38,6 2 630 CI/8	46,9 3 260 CI/8,15	75,2 5 300 CI/8,27	93,8 6 650 CI/8,31	152 10 690 CI/8,27	185 12 830 CI/8,14	281 19 690 CI/8,21	370 25 690 CI/8,15	496 33 150 CI/7,83	620 41 430 CI/7,83	732 49 960 CI/8	8	1120		
	6,3	2,2 155 CI/6,53	3,61 250 CI/6,57	4,52 315 CI/6,57	8 530 CI/6,27	9,9 660 CI/6,27	15,8 1 090 CI/6,53	34,1 2 380 CI/6,57	-	67,6 4 500 CI/6,27	-	135 9 320 CI/6,53	-	269 18 760 CI/6,57	-	480 31 890 CI/6,27	600 39 870 CI/6,27	-	6,3	900		
	5	-	-	-	-	-	-	28,4 1 930 CI/5,06	-	54,6 3 590 CI/4,89	-	110 7 580 CI/5,11	-	217 14 740 CI/5,06	-	386 25 380 CI/4,89	482 31 720 CI/4,89	-	5	710		
	4	-	-	-	-	-	-	-	-	-	-	87,2 6 090 CI/4,1	-	174 11 890 CI/4	-	309 20 600 CI/3,9	386 25 700 CI/3,9	-	4	560		

For n_1 lower than 560 min⁻¹ see page 195.

▲ Possible forced lubrication with heat exchanger: consult us.

9 - Selection tables (bevel helical gear reducers)

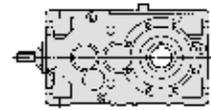
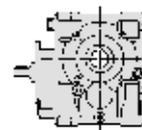

$n_{N2} \cdot L_h$ min ⁻¹ · h	i_N	P_{N2} kW																i_N	n_1	n_{N2} min ⁻¹		
		M_{N2} N m																				
		... / i																				
		50	63	64	80	81	100	125	140	160	180	200	225	250	280	320	321	360				
1 600 000	100	-	-	-	-	-	-	-	2 880 C2I/98,2	5 300 C2I/103	6 180 C2I/104	10 600 C2I/102	12 240 C2I/100	17 930 C2I/98,5	24 120 C2I/100	32 220 C2I/103	40 280 C2I/103	48 240 C2I/102				
	100	-	195 ICI/99,4	245 ICI/99,4	425 ICI/103	475 ICI/103	1 140 ICI/100	2 010 ICI/102	2 480 ICI/100	5 100 ICI/106	5 800 ICI/102	10 600 ICI/106	-	-	-	-	-	-	-			
	90	-	-	-	-	-	-	-	3 050 C2I/87,8	5 000 C2I/90,4	6 020 C2I/90	9 770 C2I/87,9	12 930 C2I/90,3	18 460 C2I/89	25 500 C2I/89,7	32 320 C2I/88,8	40 230 C2I/88,8	51 000 C2I/91,4				
	80	-	-	-	-	-	-	-	3 030 C2I/78,6	5 250 C2I/82,7	6 450 C2I/83,1	10 430 C2I/81,4	12 890 C2I/80,2	18 410 C2I/78,8	25 410 C2I/80,3	32 190 C2I/82,6	39 040 C2I/82,6	50 820 C2I/81,2				
	80	130 ICI/75,2	230 ICI/79,5	290 ICI/79,5	480 ICI/82,7	565 ICI/82,7	1 100 ICI/76,7	1 800 ICI/78,1	2 220 ICI/78,1	3 900 ICI/78,1	4 560 ICI/80,5	8 030 ICI/78,1	-	-	-	-	-	-	-			
	71	-	-	-	-	-	-	-	3 220 C2I/70,2	4 770 C2I/72,3	6 280 C2I/72	9 700 C2I/70,3	13 640 C2I/72,2	19 470 C2I/71,2	26 890 C2I/71,7	34 090 C2I/71,1	42 420 C2I/71,1	53 790 C2I/73,1				
	63	-	-	-	-	-	-	-	3 220 C2I/62	5 800 C2I/65,2	7 970 C2I/65,5	11 800 C2I/64,2	13 950 C2I/63,2	23 600 C2I/62,1	27 510 C2I/63,3	38 490 C2I/65,1	48 110 C2I/65,1	53 960 C2I/64				
	63	140 ICI/60,1	230 ICI/63,6	290 ICI/63,6	515 ICI/66,2	605 ICI/66,2	1 150 ICI/61,3	2 190 ICI/62,5	2 780 ICI/62,5	5 000 ICI/62,5	5 870 ICI/64,4	10 300 ICI/62,5	-	-	-	-	-	-	-			
	56	-	-	-	-	-	-	-	3 410 C2I/55,4	6 150 C2I/57	7 160 C2I/56,8	12 680 C2I/55,5	14 460 C2I/56,9	23 780 C2I/56,1	28 530 C2I/56,6	36 160 C2I/56	45 000 C2I/56	57 050 C2I/57,6				
	50	-	-	-	-	-	-	-	3 400 C2I/50,4	6 130 C2I/52,1	7 220 C2I/52,4	12 780 C2I/53,9	14 430 C2I/53,1	22 890 C2I/52,1	28 460 C2I/53,1	36 090 C2I/51,3	45 110 C2I/51,3	56 910 C2I/50,5				
	50	160 ICI/49	280 ICI/50,9	330 ICI/50,9	515 ICI/53	585 ICI/53	1 200 ICI/49,9	2 310 ICI/50	2 930 ICI/49,3	5 070 ICI/52,5	6 190 ICI/50,8	10 750 ICI/52,5	-	-	-	-	-	-	-			
	45	-	-	-	-	-	-	-	3 600 C2I/45,1	5 560 C2I/45,6	7 630 C2I/45,4	11 440 C2I/46,6	15 250 C2I/47,8	21 780 C2I/47,1	30 080 C2I/47,5	38 140 C2I/44,2	47 460 C2I/44,2	60 170 C2I/45,4				
	40	-	-	-	-	-	-	-	3 510 C2I/38,7	5 410 C2I/39,5	7 300 C2I/41	11 000 C2I/42,6	15 460 C2I/41,4	22 080 C2I/42,8	30 490 C2I/41,6	38 660 C2I/39,5	48 100 C2I/39,5	60 990 C2I/41				
	40	175 ICI/38,6	285 ICI/40,1	360 ICI/40,1	575 ICI/41,8	665 ICI/41,8	1 300 ICI/39,4	2 410 ICI/39,4	2 790 ICI/40,2	5 400 ICI/41,4	6 180 ICI/41,6	10 950 ICI/41,4	-	-	-	-	-	-	-			
	35,5	-	-	-	-	-	-	-	3 700 C2I/37,5	5 480 C2I/37,5	7 830 C2I/37,3	11 130 C2I/35,3	15 350 C2I/36,2	22 360 C2I/37,2	30 880 C2I/37,5	39 140 C2I/36,3	48 710 C2I/36,3	61 760 C2I/37,3				
	31,5	-	-	-	-	-	-	-	3 630 C2I/32	6 540 C2I/33,1	8 230 C2I/33,2	13 000 C2I/34,2	15 440 C2I/33,7	26 080 C2I/33,1	30 440 C2I/33,7	39 700 C2I/31,3	49 400 C2I/31,3	62 640 C2I/32,5				
31,5	170 ICI/32,1	255 ICI/33	315 ICI/33	535 ICI/31,4	585 ICI/31,4	1 160 ICI/32,8	2 270 ICI/32,4	-	4 790 ICI/31,4	-	9 850 ICI/32,7	-	-	-	-	-	-	-				
31,5	-	220 CI/31,3	245 CI/31,3	450 CI/32,5	560 CI/32,5	970 CI/30,1	1 850 CI/31,3	-	3 650 CI/30,8	-	6 490 CI/30,8	-	12 620 CI/31,7	-	-	-	-	-				

For n_1 lower than 560 min⁻¹ see page 195.

9 - Selection tables (bevel helical gear reducers)

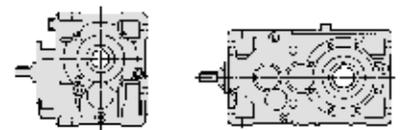

$n_{N2} \cdot L_h$ min ⁻¹ · h	i_N	P_{N2} kW																i_N	n_1 min ⁻¹	n_{N2} min ⁻¹		
		M_{N2} N m																				
		... / i																				
		50	63	64	80	81	100	125	140	160	180	200	225	250	280	320	321	360				
1 600 000	28	-	-	-	-	-	-	-	3 800 C2I/28,6	6 680 C2I/28,9	8 050 C2I/28,8	12 100 C2I/29,5	16 110 C2I/30,3	26 680 C2I/29,9	31 770 C2I/30,1	40 270 C2I/28	50 110 C2I/28	63 530 C2I/28,8				
	25	-	-	-	-	-	-	-	3 620 C2I/24,5	6 000 C2I/25,1	7 520 C2I/26	11 620 C2I/27	16 070 C2I/26,3	25 150 C2I/27,2	32 220 C2I/26,4	40 850 C2I/25,1	50 830 C2I/25,1	64 450 C2I/26				
	25	145 CI/24,1	230 CI/25	290 CI/25	520 CI/26	605 CI/26	1 030 CI/24,1	2 160 CI/25	-	4 270 CI/24,6	-	8 540 CI/24,6	-	17 480 CI/25,4	-	-	-	-	-			
	22,4	-	-	-	-	-	-	-	47,7 3 870 C2I/23,8	72,7 5 890 C2I/23,8	102 8 210 C2I/23,7	153 11 660 C2I/22,4▲	207 16 250 C2I/23,6	-	-	-	-	-	22,4	2800	125	
	20	-	-	-	-	-	-	-	44 3 430 C2I/20,4	74,1 5 820 C2I/20,6	93,8 7 650 C2I/21,4	151 11 820 C2I/20,5	188 14 270 C2I/19,9	-	-	-	-	-	20	2500		
	20	1,99 145 CI/19,3	3,26 250 CI/20	4,01 305 CI/20	6,68 530 CI/20,8	7,72 615 CI/20,8	14,9 1 100 CI/19,3	28,7 2 190 CI/20	41,3 3 150 CI/20	63,5 4 780 CI/19,7	81,4 6 310 CI/20,3	131 9 820 CI/19,7	163 12 610 CI/20,3	-	-	-	-	-	20	2500		
	18	-	-	-	-	-	-	-	42,1 3 230 CI/18	66,3 5 090 CI/18	84,2 6 700 CI/18,7	132 10 130 CI/18	167 13 270 CI/18,7	265 20 150 CI/17,9	334 25 640 CI/18	-	-	-	18	2240		
	16	2,02 145 CI/15,2	3,38 255 CI/15,8	4,15 315 CI/15,8	6,91 540 CI/16,4	7,98 625 CI/16,4	15,4 1 110 CI/15,2	31,8 2 400 CI/15,8	42,9 3 230 CI/15,8	65,4 4 850 CI/15,5	89,7 6 850 CI/16	134 9 960 CI/15,5	178 13 620 CI/16	261 19 920 CI/16	362 27 270 CI/15,8	418 32 460 CI/16,3	521 40 480 CI/16,3	680 51 960 CI/16	16	2000		
	14	-	-	-	-	-	-	-	45,5 3 420 CI/14,2	71,1 5 350 CI/14,2	90,9 7 100 CI/14,7	145 10 940 CI/14,2	179 13 980 CI/14,7	293 21 880 CI/14,1	358 26 960 CI/14,2	466 35 070 CI/14,2	553 41 620 CI/14,2	710 54 680 CI/14,5	14	1800		
	12,5	2,14 160 CI/12,4	3,84 290 CI/12,6	4,87 365 CI/12,6	8,19 640 CI/13,1	9,48 745 CI/13,1	17,2 1 270 CI/12,4	34,9 2 630 CI/12,6	41 3 150 CI/12,9	71,7 5 580 CI/13	82 6 410 CI/13,1	143 11 160 CI/13	166 12 730 CI/12,8	287 21 600 CI/12,6	323 24 770 CI/12,9	438 33 510 CI/12,8	536 41 030 CI/12,8	640 48 220 CI/12,6	12,5	1600		
	11,2	-	-	-	-	-	-	-	47,4 3 640 CI/11,3	63,8 4 960 CI/11,4	97,1 7 720 CI/11,7	128 9 800 CI/11,3	193 15 320 CI/11,7	255 19 840 CI/11,4	385 29 550 CI/11,3	456 34 300 CI/11	569 42 880 CI/11	714 56 010 CI/11,5	11,2	1400		
	10	1,94 155 CI/10,3	4,03 310 CI/10	4,92 375 CI/10	8,17 650 CI/10,4	9,46 755 CI/10,4	17,7 1 330 CI/9,81	34,7 2 650 CI/10	44 3 430 CI/10,2	67,8 5 350 CI/10,3	88,1 6 990 CI/10,4	138 10 880 CI/10,3	174 13 500 CI/10,2	279 21 300 CI/10	347 27 030 CI/10,2	489 37 950 CI/10,2	598 46 440 CI/10,2	685 52 330 CI/10	10	1250		
9	-	-	-	-	-	-	-	46,9 3 600 CI/9	70,5 5 430 CI/9,04	93,8 7 470 CI/9,33	141 10 700 CI/8,93	185 14 700 CI/9,33	281 21 660 CI/9,04	370 28 360 CI/9	496 37 030 CI/8,75	620 46 280 CI/8,75	714 56 010 CI/9,2	9	1120			
8	2,14 160 CI/7,85	3,91 300 CI/8	4,92 375 CI/8	8,17 650 CI/8,33	9,46 755 CI/8,33	17,4 1 310 CI/7,85	34,7 2 650 CI/8	42,3 3 290 CI/8,15	67,8 5 350 CI/8,27	84,6 6 710 CI/8,31	140 11 060 CI/8,27	167 12 960 CI/8,14	253 19 870 CI/8,21	333 25 950 CI/8,15	447 33 450 CI/7,83	560 41 890 CI/7,83	660 50 440 CI/8	8	1000			
6,3	2,03 160 CI/6,53	3,33 260 CI/6,57	4,16 325 CI/6,57	7,15 535 CI/6,27	9,12 680 CI/6,27	14,1 1 100 CI/6,53	30,9 2 420 CI/6,57	-	60,8 4 550 CI/6,27	-	121 9 420 CI/6,53	-	242 18 950 CI/6,57	-	431 32 210 CI/6,27	538 40 260 CI/6,27	-	6,3	800			
5	-	-	-	-	-	-	26,1 2 000 CI/5,06	-	49 3 630 CI/4,89	-	101 7 850 CI/5,11	-	195 14 950 CI/5,06	-	346 25 630 CI/4,89	432 32 040 CI/4,89	-	5	630			
1 400 000	125	-	-	-	-	-	-	2 660 C2I/123	5 150 C2I/129	6 020 C2I/130	10 300 C2I/127	11 670 C2I/125	17 470 C2I/123	21 000 C2I/125	30 700 C2I/129	38 370 C2I/129	41 820 C2I/127					
	125	-	-	-	-	1000 ICI/123	2 000 ICI/127	2 430 ICI/127	4 370 ICI/126	6 050 ICI/130	9 000 ICI/126	-	-	-	-	-	-					

For n_1 lower than 560 min⁻¹ see page 195.

9 - Selection tables (bevel helical gear reducers)

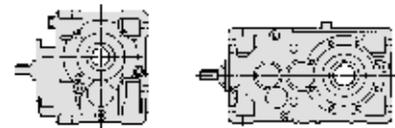

$n_{N2} \cdot L_h$ min ⁻¹ · h	i_N	P_{N2} kW M_{N2} N m ... / i																i_N	n_1 min ⁻¹	n_{N2} min ⁻¹	
		50	63	64	80	81	100	125	140	160	180	200	225	250	280	320	321				360
1 400 000	100	-	-	-	-	-	-	2 960 C2I/98,2	5 450 C2I/103	6 390 C2I/104	10 900 C2I/102	12 570 C2I/100	18 530 C2I/98,5	24 780 C2I/100	33 300 C2I/103	41 630 C2I/103	49 560 C2I/102				
	100	-	200 ICI/99,4	250 ICI/99,4	435 ICI/103	485 ICI/103	1 180 ICI/100	2 080 ICI/102	2 550 ICI/100	5 270 ICI/106	6 000 ICI/102	11 070 ICI/106	-	-	-	-	-				
	90	-	-	-	-	-	-	3 130 C2I/87,8	5 170 C2I/90,4	6 170 C2I/90	10 110 C2I/87,9	13 260 C2I/90,3	18 930 C2I/89	26 150 C2I/89,7	33 150 C2I/88,8	41 250 C2I/88,8	52 300 C2I/91,4				
	80	-	-	-	-	-	-	3 120 C2I/78,6	5 420 C2I/82,7	6 630 C2I/83,1	10 760 C2I/81,4	13 260 C2I/80,2	18 940 C2I/78,8	26 140 C2I/80,3	33 110 C2I/82,6	40 150 C2I/82,6	52 270 C2I/81,2				
	80	135 ICI/75,2	235 ICI/79,5	290 ICI/79,5	500 ICI/82,7	585 ICI/82,7	1 130 ICI/76,7	1 850 ICI/78,1	2 280 ICI/78,1	4 020 ICI/78,1	4 710 ICI/80,5	8 260 ICI/78,1	-	-	-	-	-				
	71	-	-	-	-	-	-	3 320 C2I/70,2	4 930 C2I/72,3	6 480 C2I/72	10 010 C2I/70,3	14 080 C2I/72,2	20 100 C2I/71,2	27 760 C2I/71,7	35 190 C2I/71,1	43 800 C2I/71,1	55 530 C2I/73,1				
	63	-	-	-	-	-	-	3 310 C2I/62	6 000 C2I/65,2	8 260 C2I/65,5	12 200 C2I/64,2	14 460 C2I/63,2	24 300 C2I/62,1	28 510 C2I/63,3	39 890 C2I/65,1	49 870 C2I/65,1	55 440 C2I/64				
	63	140 ICI/60,1	235 ICI/63,6	290 ICI/63,6	515 ICI/66,2	605 ICI/66,2	1 180 ICI/61,3	2 270 ICI/62,5	2 850 ICI/62,5	5 150 ICI/62,5	6 030 ICI/64,4	10 600 ICI/62,5	-	-	-	-	-				
	56	-	-	-	-	-	-	3 510 C2I/55,4	6 300 C2I/57	7 420 C2I/56,8	13 140 C2I/55,5	14 850 C2I/56,9	24 650 C2I/56,1	29 280 C2I/56,6	37 120 C2I/56	46 190 C2I/56	58 560 C2I/57,6				
	50	-	-	-	-	-	-	3 490 C2I/50,4	6 350 C2I/52,1	7 420 C2I/52,4	13 050 C2I/53,9	14 830 C2I/53,1	23 720 C2I/52,1	29 240 C2I/53,1	37 380 C2I/51,3	46 730 C2I/51,3	58 470 C2I/50,5				
	50	160 ICI/49	280 ICI/50,9	330 ICI/50,9	530 ICI/53	600 ICI/53	1 240 ICI/49,9	2 370 ICI/50	3 010 ICI/49,3	5 250 ICI/52,5	6 400 ICI/50,8	11 070 ICI/52,5	-	-	-	-	-				
	45	-	-	-	-	-	-	3 650 C2I/45,1	5 750 C2I/45,6	7 730 C2I/45,4	11 830 C2I/46,6	15 460 C2I/47,8	22 180 C2I/47,1	30 490 C2I/47,5	38 660 C2I/44,2	48 100 C2I/44,2	60 990 C2I/45,4				
	40	-	-	-	-	-	-	3 550 C2I/38,7	5 480 C2I/39,5	7 390 C2I/41	11 170 C2I/42,6	15 660 C2I/41,4	22 360 C2I/42,8	30 880 C2I/41,6	39 140 C2I/39,5	48 710 C2I/39,5	61 760 C2I/41				
	40	175 ICI/38,6	285 ICI/40,1	360 ICI/40,1	585 ICI/41,8	675 ICI/41,8	1 350 ICI/39,4	2 440 ICI/39,4	2 830 ICI/40,2	5 570 ICI/41,4	6 260 ICI/41,6	11 300 ICI/41,4	-	-	-	-	-				
	35,5	-	-	-	-	-	-	3 750 C2I/37,5	5 560 C2I/37,5	7 940 C2I/37,3	11 290 C2I/35,3	15 570 C2I/36,2	22 670 C2I/37,2	31 320 C2I/37,5	39 700 C2I/36,3	49 400 C2I/36,3	62 640 C2I/37,3				
	31,5	-	-	-	-	-	-	3 690 C2I/32	6 570 C2I/33,1	8 530 C2I/33,2	13 050 C2I/34,2	15 660 C2I/33,7	26 180 C2I/33,1	30 870 C2I/33,7	40 270 C2I/31,3	50 110 C2I/31,3	63 530 C2I/32,5				
	31,5	175 ICI/32,1	260 ICI/33	325 ICI/33	540 ICI/31,4	595 ICI/31,4	1 200 ICI/32,8	2 300 ICI/32,4	-	4 860 ICI/31,4	-	9 990 ICI/32,7	-	-	-	-	-				
	31,5	-	225 CI/31,3	250 CI/31,3	455 CI/32,5	565 CI/32,5	975 CI/30,1	1 900 CI/31,3	-	3 810 CI/30,8	-	6 730 CI/30,8	-	13 080 CI/31,7	-	-	-				

For n_1 lower than 560 min⁻¹ see page 195.

▲ Possible forced lubrication with heat exchanger: consult us.

9 - Selection tables (bevel helical gear reducers)

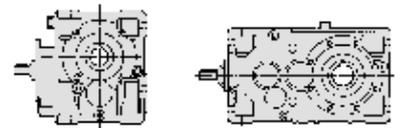

$n_{N2} \cdot L_h$ min ⁻¹ · h	i_N	P_{N2} kW																i_N	n_1 min ⁻¹	n_{N2} min ⁻¹		
		M_{N2} N m																				
		... / i																				
		50	63	64	80	81	100	125	140	160	180	200	225	250	280	320	321	360				
1 400 000	28	-	-	-	-	-	-	-	3 860 C21/28,6	6 920 C21/28,9	8 170 C21/28,8	12 550 C21/29,5	16 340 C21/30,3	26 790 C21/29,9	32 220 C21/30,1	40 850 C21/28	50 830 C21/28	64 450 C21/28,8				
	25	-	-	-	-	-	-	-	43,8 3 670 C21/24,5	72,7 6 220 C21/25,1	86 7 630 C21/26	129 11 890 C21/27 ▲	182 16 300 C21/26,3 ▲	-	-	-	-	-	25	2800	112	
	25	1,79 145 C1/24,1	2,74 235 C1/25	3,44 295 C1/25	5,94 525 C1/26	6,85 605 C1/26	12,8 1 050 C1/24,1	25,7 2 190 C1/25	-	51,6 4 330 C1/24,6	-	103 8 660 C1/24,6	-	-	-	-	-	-	25	2800		
	22,4	-	-	-	-	-	-	-	43,2 3 930 C21/23,8	67,2 6 100 C21/23,8	92,1 8 320 C21/23,7	139 11 900 C21/22,4	188 16 470 C21/23	-	-	-	-	-	22,4	2500		
	20	-	-	-	-	-	-	-	39,9 3 470 C21/20,4	67,2 5 900 C21/20,6	85,2 7 750 C21/21,4	137 11 970 C21/20,5	170 14 450 C21/19,9	263 24 080 C21/21,5 ▲	335 29 770 C21/20,8 ▲	-	-	-	20	2240		
	20	1,79 145 C1/19,3	2,96 255 C1/20	3,64 310 C1/20	6,06 540 C1/20,8	7 620 C1/20,8	13,7 1 130 C1/19,3	26 2 220 C1/20	37,5 3 200 C1/20	57,7 4 840 C1/19,7	73,9 6 390 C1/20,3	119 9 950 C1/19,7	148 12 780 C1/20,3	230 19 910 C1/20,3	296 25 250 C1/20	-	-	-	20	2240		
	18	-	-	-	-	-	-	-	38,1 3 280 C1/18	60 5 160 C1/18	76,2 6 790 C1/18,7	119 10 270 C1/18	151 13 450 C1/18,7	239 20 430 C1/17,9	302 25 990 C1/18	366 31 420 C1/18	462 39 670 C1/18	600 52 700 C1/18,4	18	2000		
	16	1,82 145 C1/15,2	3,08 260 C1/15,8	3,78 315 C1/15,8	6,3 550 C1/16,4	7,28 635 C1/16,4	14 1 130 C1/15,2	29,6 2 470 C1/15,8	39,1 3 270 C1/15,8	59,7 4 910 C1/15,5	81,7 6 940 C1/16	123 10 130 C1/15,5	162 13 790 C1/16	237 20 170 C1/16	330 27 620 C1/15,8	381 32 870 C1/16,3	475 41 000 C1/16,3	620 52 620 C1/16	16	1800		
	14	-	-	-	-	-	-	-	41 3 470 C1/14,2	64,1 5 430 C1/14,2	82 7 200 C1/14,7	131 11 090 C1/14,2	161 14 180 C1/14,7	264 22 190 C1/14,1	323 27 340 C1/14,2	420 35 570 C1/14,2	498 42 210 C1/14,2	640 55 460 C1/14,5	14	1600		
	12,5	1,9 160 C1/12,4	3,42 295 C1/12,6	4,33 370 C1/12,6	7,28 650 C1/13,1	8,42 755 C1/13,1	15,3 1 290 C1/12,4	31 2 670 C1/12,6	36,4 3 200 C1/12,9	63,8 5 670 C1/13	72,9 6 510 C1/13,1	128 11 340 C1/13	151 13 250 C1/12,8	255 21 950 C1/12,6	287 25 170 C1/12,9	389 34 050 C1/12,8	476 41 690 C1/12,8	569 49 000 C1/12,6	12,5	1400		
	11,2	-	-	-	-	-	-	-	42,6 3 660 C1/11,3	57,6 5 020 C1/11,4	87,2 7 780 C1/11,7	115 9 900 C1/11,3	174 15 470 C1/11,7	230 20 050 C1/11,4	347 29 840 C1/11,3	411 34 640 C1/11	513 43 300 C1/11	644 56 560 C1/11,5	11,2	1250		
	10	1,79 155 C1/10,3	3,62 310 C1/10	4,42 375 C1/10	7,34 650 C1/10,4	8,5 755 C1/10,4	15,9 1 330 C1/9,81	31,3 2 670 C1/10	39,7 3 450 C1/10,2	61,3 5 400 C1/10,3	79,6 7 050 C1/10,4	128 11 250 C1/10,3	159 13 790 C1/10,2	252 21 490 C1/10	314 27 290 C1/10,2	442 38 320 C1/10,2	541 46 860 C1/10,2	620 52 890 C1/10	10	1120		
	9	-	-	-	-	-	-	-	42,3 3 640 C1/9	63,6 5 490 C1/9,04	84,6 7 540 C1/9,33	127 10 860 C1/8,93	167 14 850 C1/9,33	253 21 870 C1/9,04	333 28 650 C1/9	447 37 370 C1/8,75	560 46 790 C1/8,75	644 56 560 C1/9,2	9	1000		
	8	1,97 165 C1/7,85	3,54 300 C1/8	4,44 375 C1/8	7,37 650 C1/8,33	8,54 755 C1/8,33	15,8 1 310 C1/7,85	31,4 2 670 C1/8	38,4 3 320 C1/8,15	61,6 5 400 C1/8,27	76,9 6 780 C1/8,31	130 11 410 C1/8,27	151 13 080 C1/8,14	230 20 050 C1/8,21	303 26 200 C1/8,15	406 33 740 C1/7,83	509 42 310 C1/7,83	600 50 890 C1/8	8	900		
	6,3	1,85 160 C1/6,53	3,06 270 C1/6,57	3,82 340 C1/6,57	6,37 535 C1/6,27	8,27 695 C1/6,27	12,6 1 100 C1/6,53	28,4 2 510 C1/6,57	-	54,6 4 600 C1/6,27	-	110 9 680 C1/6,53	-	217 19 150 C1/6,57	-	386 32 530 C1/6,27	482 40 660 C1/6,27	-	6,3	710		
5	-	-	-	-	-	-	24,1 2 070 C1/5,06	-	44,1 3 670 C1/4,89	-	93,3 8 130 C1/5,11	-	180 15 490 C1/5,06	-	310 25 880 C1/4,89	388 32 340 C1/4,89	-	5	560			
1 250 000	125	-	-	-	-	-	-	2 750 C21/123	5 300 C21/129	6 230 C21/130	10 600 C21/127	12 070 C21/125	18 070 C21/123	21 550 C21/125	31 760 C21/129	39 700 C21/129	42 930 C21/127					
	125	-	-	-	-	1 030 ICI/123	2 060 ICI/127	2 510 ICI/127	4 500 ICI/126	6 260 ICI/130	9 250 ICI/126	-	-	-	-	-	-					

For n_1 lower than 560 min⁻¹ see page 195.

▲ Possible forced lubrication with heat exchanger: consult us.

9 - Selection tables (bevel helical gear reducers)

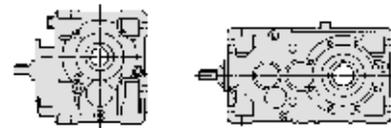

$n_{N2} \cdot L_h$ min ⁻¹ · h	i_N	P_{N2} kW M_{N2} N m ... / i																i_N	n_1 min ⁻¹	n_{N2} min ⁻¹	
		50	63	64	80	81	100	125	140	160	180	200	225	250	280	320	321				360
1 250 000	100	-	-	-	-	-	-	-	3 030 C2I/98,2	5 600 C2I/103	6 610 C2I/104	11 200 C2I/102	12 890 C2I/100	19 170 C2I/98,5	25 410 C2I/100	34 450 C2I/103	43 070 C2I/103	50 820 C2I/102			
	100	-	205 ICI/99,4	250 ICI/99,4	450 ICI/103	500 ICI/103	1 180 ICI/100	2 150 ICI/102	2 610 ICI/100	5 460 ICI/106	6 150 ICI/102	11 110 ICI/106	-	-	-	-	-	-			
	90	-	-	-	-	-	-	-	3 220 C2I/87,8	5 340 C2I/90,4	6 350 C2I/90	10 430 C2I/87,9	13 640 C2I/90,3	19 470 C2I/89	26 890 C2I/89,7	34 090 C2I/88,8	42 420 C2I/88,8	53 790 C2I/91,4			
	80	-	-	-	-	-	-	-	3 220 C2I/78,6	5 610 C2I/82,7	6 840 C2I/83,1	11 150 C2I/81,4	13 690 C2I/80,2	19 550 C2I/78,8	26 980 C2I/80,3	34 180 C2I/82,6	41 460 C2I/82,6	53 960 C2I/81,2			
	80	140 ICI/75,2	235 ICI/79,5	295 ICI/79,5	515 ICI/82,7	605 ICI/82,7	1 180 ICI/76,7	1 920 ICI/78,1	2 360 ICI/78,1	4 150 ICI/78,1	4 790 ICI/80,5	8 520 ICI/78,1	-	-	-	-	-	-			
	71	-	-	-	-	-	-	-	3 410 C2I/70,2	5 090 C2I/72,3	6 660 C2I/72	10 290 C2I/70,3	14 460 C2I/72,2	20 650 C2I/71,2	28 530 C2I/71,7	36 160 C2I/71,1	45 000 C2I/71,1	57 050 C2I/73,1			
	63	-	-	-	-	-	-	-	3 400 C2I/62	6 150 C2I/65,2	8 560 C2I/65,5	12 500 C2I/64,2	14 980 C2I/63,2	25 000 C2I/62,1	29 550 C2I/63,3	41 350 C2I/65,1	51 690 C2I/65,1	56 910 C2I/64			
	63	145 ICI/60,1	235 ICI/63,6	295 ICI/63,6	520 ICI/66,2	610 ICI/66,2	1 220 ICI/61,3	2 350 ICI/62,5	2 930 ICI/62,5	5 300 ICI/62,5	6 220 ICI/64,4	11 150 ICI/62,5	-	-	-	-	-	-			
	56	-	-	-	-	-	-	-	3 600 C2I/55,4	6 500 C2I/57	7 680 C2I/56,8	13 200 C2I/55,5	15 250 C2I/56,9	25 530 C2I/56,1	30 080 C2I/56,6	38 140 C2I/56	47 460 C2I/56	60 170 C2I/57,6			
	50	-	-	-	-	-	-	-	3 540 C2I/50,4	6 570 C2I/52,1	7 520 C2I/52,4	13 100 C2I/53,9	15 030 C2I/53,1	24 540 C2I/52,1	29 730 C2I/53,1	38 680 C2I/51,3	48 350 C2I/51,3	59 270 C2I/50,5			
	50	160 ICI/49	285 ICI/50,9	335 ICI/50,9	540 ICI/53	610 ICI/53	1 240 ICI/49,9	2 410 ICI/50	3 050 ICI/49,3	5 430 ICI/52,5	6 620 ICI/50,8	11 110 ICI/52,5	-	-	-	-	-	-			
	45	-	-	-	-	-	-	-	3 700 C2I/45,1	5 930 C2I/45,6	7 830 C2I/45,4	12 210 C2I/46,6	15 660 C2I/47,8	22 890 C2I/47,1	30 880 C2I/47,5	39 140 C2I/44,2	48 710 C2I/44,2	61 760 C2I/45,4			
	40	-	-	-	-	-	-	-	3 600 C2I/38,7	5 560 C2I/39,5	7 500 C2I/41	11 570 C2I/42,6	15 880 C2I/41,4	22 670 C2I/42,8	31 320 C2I/41,6	39 700 C2I/39,5	49 400 C2I/39,5	62 640 C2I/41			
	40	175 ICI/38,6	290 ICI/40,1	360 ICI/40,1	590 ICI/41,8	685 ICI/41,8	1 390 ICI/39,4	2 470 ICI/39,4	2 870 ICI/40,2	5 770 ICI/41,4	6 350 ICI/41,6	11 710 ICI/41,4	-	-	-	-	-	-			
	35,5	-	-	-	-	-	-	-	3 800 C2I/37,5	5 640 C2I/37,5	8 050 C2I/37,3	11 450 C2I/35,3	15 790 C2I/36,2	23 000 C2I/37,2	31 770 C2I/37,5	40 270 C2I/36,3	50 110 C2I/36,3	63 530 C2I/37,3			
	31,5	-	-	-	-	-	-	-	3 740 C2I/32	6 590 C2I/33,1	8 840 C2I/33,2	13 100 C2I/34,2	15 890 C2I/33,7	26 280 C2I/33,1	31 320 C2I/33,7	40 850 C2I/31,3	50 830 C2I/31,3	64 450 C2I/32,5			
31,5	175 ICI/32,1	270 ICI/33	340 ICI/33	550 ICI/31,4	600 ICI/31,4	1 250 ICI/32,8	2 330 ICI/32,4	-	4 930 ICI/31,4	-	10 130 ICI/32,7	-	-	-	-	-	-				
31,5	-	225 CI/31,3	250 CI/31,3	455 CI/32,5	565 CI/32,5	1000 CI/30,1	1 950 CI/31,3	-	3 830 CI/30,8	-	6 970 CI/30,8	-	13 560 CI/31,7	-	-	-	-				

For n_1 lower than 560 min⁻¹ see page 195.

▲ Possible forced lubrication with heat exchanger: consult us.

9 - Selection tables (bevel helical gear reducers)

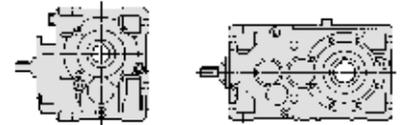

$n_{N2} \cdot L_h$ min ⁻¹ · h	i_N	P_{N2} kW																i_N	n_1	n_{N2} min ⁻¹		
		M_{N2} N m																				
		... / i																				
		50	63	64	80	81	100	125	140	160	180	200	225	250	280	320	321	360				
1 250 000	28	-	-	-	-	-	-	-	40,1 3 910 C21/28,6	72,7 7 170 C21/28,9	84,3 8 290 C21/28,8	129 13 000 C21/29,5▲	160 16 570 C21/30,3▲	-	-	-	-	-	28	2800	100	
	25	-	-	-	-	-	-	-	39,7 3 720 C21/24,5	67,2 6 430 C21/25,1	77,8 7 730 C21/26	119 12 300 C21/27	165 16 520 C21/26,3	-	-	-	-	-	25	2500		
	25	1,6 145 C1/24,1	2,47 235 C1/25	3,11 295 C1/25	5,38 535 C1/26	6,13 610 C1/26	11,5 1 050 C1/24,1	23,2 2 220 C1/25	-	46,7 4 390 C1/24,6	-	93,4 8 780 C1/24,6	-	-	-	-	-	-	25	2500		
	22,4	-	-	-	-	-	-	-	39,2 3 980 C21/23,8	62,2 6 300 C21/23,8	83,6 8 430 C21/23,7	129 12 300 C21/22,4	170 16 680 C21/23	241 24 300 C21/23,6▲	328 33 240 C21/23,8▲	-	-	-	-	22,4	2240	
	20	-	-	-	-	-	-	-	36,1 3 520 C21/20,4	60,8 5 980 C21/20,6	77,1 7 860 C21/21,4	124 12 140 C21/20,5	154 14 650 C21/19,9	238 24 410 C21/21,5	303 30 170 C21/20,8	-	-	-	-	20	2000	
	20	1,6 145 C1/19,3	2,68 255 C1/20	3,3 315 C1/20	5,49 545 C1/20,8	6,34 630 C1/20,8	12,7 1 170 C1/19,3	23,6 2 250 C1/20	33,9 3 240 C1/20	52,2 4 910 C1/19,7	66,9 6 480 C1/20,3	107 10 090 C1/19,7	134 12 950 C1/20,3	208 20 180 C1/20,3	268 25 590 C1/20	352 33 080 C1/19,7	461 43 310 C1/19,7	521 50 490 C1/20,3	20	2000		
	18	-	-	-	-	-	-	-	34,7 3 320 C1/18	54,7 5 220 C1/18,7	69,5 6 880 C1/18,7	109 10 400 C1/18	138 13 630 C1/18,7	218 20 690 C1/17,9	276 26 320 C1/18	333 31 820 C1/18	428 40 860 C1/18	547 53 370 C1/18,4	18	1800		
	16	1,62 145 C1/15,2	2,78 260 C1/15,8	3,41 320 C1/15,8	5,68 555 C1/16,4	6,56 640 C1/16,4	12,7 1 150 C1/15,2	26,7 2 510 C1/15,8	35,3 3 320 C1/15,8	54,9 5 090 C1/15,5	73,7 7 030 C1/16	113 10 490 C1/15,5	148 14 130 C1/16	214 20 460 C1/16	298 28 010 C1/15,8	343 33 340 C1/16,3	428 41 580 C1/16,3	559 53 360 C1/16	16	1600		
	14	-	-	-	-	-	-	-	36,4 3 530 C1/14,2	57 5 510 C1/14,2	72,9 7 320 C1/14,7	116 11 270 C1/14,2	143 14 410 C1/14,7	235 22 540 C1/14,1	287 27 780 C1/14,2	373 36 140 C1/14,2	443 42 890 C1/14,2	569 56 350 C1/14,5	14	1400		
	12,5	1,73 165 C1/12,4	3,07 295 C1/12,6	3,88 375 C1/12,6	6,52 655 C1/13,1	7,55 760 C1/13,1	13,7 1 290 C1/12,4	27,9 2 680 C1/12,6	32,9 3 230 C1/12,9	57,6 5 740 C1/13	65,7 6 580 C1/13,1	115 11 460 C1/13	139 13 660 C1/12,8	230 22 180 C1/12,6	259 25 430 C1/12,9	351 34 380 C1/12,8	430 42 100 C1/12,8	513 49 490 C1/12,6	12,5	1250		
	11,2	-	-	-	-	-	-	-	38,4 3 680 C1/11,3	52,2 5 080 C1/11,4	78,7 7 830 C1/11,7	104 10 000 C1/11,3	157 15 610 C1/11,7	208 20 240 C1/11,4	314 30 120 C1/11,3	372 34 970 C1/11	464 43 710 C1/11	582 57 100 C1/11,5	11,2	1120		
	10	1,65 160 C1/10,3	3,24 310 C1/10	3,96 380 C1/10	6,58 655 C1/10,4	7,61 755 C1/10,4	14,3 1 340 C1/9,81	28,1 2 680 C1/10	35,4 3 450 C1/10,2	55,3 5 450 C1/10,3	71,8 7 120 C1/10,4	118 11 640 C1/10,3	147 14 270 C1/10,2	227 21 690 C1/10	283 27 550 C1/10,2	399 38 700 C1/10,2	487 47 290 C1/10,2	560 53 470 C1/10	10	1000		
	9	-	-	-	-	-	-	-	38,4 3 670 C1/9	57,8 5 540 C1/9,04	76,9 7 610 C1/9,33	118 11 200 C1/8,93	151 15 000 C1/9,33	230 22 060 C1/9,04	303 28 920 C1/9	406 37 680 C1/8,75	509 47 260 C1/8,75	585 57 080 C1/9,2	9	900		
	8	1,82 170 C1/7,85	3,16 300 C1/8	3,96 380 C1/8	6,58 655 C1/8,33	7,61 755 C1/8,33	14,1 1 320 C1/7,85	28,1 2 680 C1/8	34,5 3 360 C1/8,15	55,3 5 450 C1/8,27	69 6 850 C1/8,31	120 11 820 C1/8,27	136 13 220 C1/8,14	206 20 240 C1/8,21	272 26 470 C1/8,15	364 34 050 C1/7,83	458 42 790 C1/7,83	538 51 400 C1/8	8	800		
6,3	1,65 165 C1/6,53	2,81 280 C1/6,57	3,52 350 C1/6,57	5,68 540 C1/6,27	7,37 700 C1/6,27	11,2 1 110 C1/6,53	26,1 2 600 C1/6,57	-	49 4 660 C1/6,27	-	101 10 040 C1/6,53	-	194 19 340 C1/6,57	-	346 32 850 C1/6,27	432 41 060 C1/6,27	-	6,3	630			
1 120 000	160	-	-	-	-	-	-	2 900 C21/151	4 370 C21/154	6 300 C21/158	9 000 C21/151	12 500 C21/156	18 000 C21/156	24 260 C21/154	31 500 C21/156	37 500 C21/156	47 850 C21/161					
	160	-	-	-	-	1000 ICI/154	2 000 ICI/159	2 120 ICI/159	4 370 ICI/157	5 100 ICI/162	7 420 ICI/157	-	-	-	-	-	-					
	125	-	-	-	-	-	-	2 840 C21/123	5 450 C21/129	6 440 C21/130	10 900 C21/127	12 470 C21/125	18 680 C21/123	22 140 C21/125	32 820 C21/129	41 030 C21/129	44 110 C21/127					

For n_1 lower than 560 min⁻¹ see page 195.

▲ Possible forced lubrication with heat exchanger: consult us.

9 - Selection tables (bevel helical gear reducers)

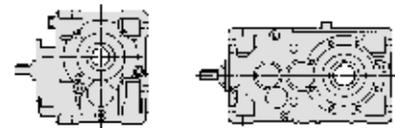

$n_{N2} \cdot L_h$ min ⁻¹ · h	i_N	P_{N2} kW																i_N	n_1	n_{N2}		
		M_{N2} N m																				
		... / i																				
		50	63	64	80	81	100	125	140	160	180	200	225	250	280	320	321	360				
1 120 000	125	-	-	-	-	-	1 060 ICI/123	2 120 ICI/127	2 600 ICI/127	4 620 ICI/126	6 470 ICI/130	9 500 ICI/126	-	-	-	-	-	-				
	100	-	-	-	-	-	-	-	3 120 C2I/98,2	5 600 C2I/103	6 820 C2I/104	11 500 C2I/102	13 260 C2I/100	19 790 C2I/98,5	26 140 C2I/100	35 560 C2I/103	44 450 C2I/103	52 270 C2I/102				
	100	-	210 ICI/99,4	255 ICI/99,4	460 ICI/103	515 ICI/103	1 250 ICI/100	2 220 ICI/102	2 690 ICI/100	5 630 ICI/106	6 300 ICI/102	11 150 ICI/106	-	-	-	-	-	-	-			
	90	-	-	-	-	-	-	-	3 320 C2I/87,8	5 530 C2I/90,4	6 560 C2I/90	10 810 C2I/87,9	14 080 C2I/90,3	20 100 C2I/89	27 760 C2I/89,7	35 190 C2I/88,8	43 800 C2I/88,8	55 530 C2I/91,4				
	80	-	-	-	-	-	-	-	3 310 C2I/78,6	5 810 C2I/82,7	7 030 C2I/83,1	11 550 C2I/81,4	14 060 C2I/80,2	20 090 C2I/78,8	27 720 C2I/80,3	35 110 C2I/82,6	42 970 C2I/82,6	55 440 C2I/81,2				
	80	140 ICI/75,2	235 ICI/79,5	295 ICI/79,5	520 ICI/82,7	610 ICI/82,7	1 190 ICI/76,7	1 990 ICI/78,1	2 420 ICI/78,1	4 260 ICI/78,1	4 870 ICI/80,5	8 760 ICI/78,1	-	-	-	-	-	-	-			
	71	-	-	-	-	-	-	-	3 510 C2I/70,2	5 270 C2I/72,3	6 840 C2I/72	10 560 C2I/70,3	14 850 C2I/72,2	21 200 C2I/71,2	29 280 C2I/71,7	37 120 C2I/71,1	46 190 C2I/71,1	58 560 C2I/73,1				
	63	-	-	-	-	-	-	-	3 490 C2I/62	6 300 C2I/65,2	8 870 C2I/65,5	13 120 C2I/64,2	15 520 C2I/63,2	26 330 C2I/62,1	30 610 C2I/63,3	42 840 C2I/65,1	53 550 C2I/65,1	58 470 C2I/64				
	63	150 ICI/60,1	235 ICI/63,6	295 ICI/63,6	520 ICI/66,2	610 ICI/66,2	1 250 ICI/61,3	2 430 ICI/62,5	3 010 ICI/62,5	5 540 ICI/62,5	6 440 ICI/64,4	11 190 ICI/62,5	-	-	-	-	-	-	-			
	56	-	-	-	-	-	-	-	3 650 C2I/55,4	6 700 C2I/57	7 890 C2I/56,8	13 600 C2I/55,5	15 460 C2I/56,9	26 420 C2I/56,1	30 490 C2I/56,6	38 660 C2I/56	48 100 C2I/56	60 990 C2I/57,6				
	50	-	-	-	-	-	-	-	3 580 C2I/50,4	6 610 C2I/52,1	7 610 C2I/52,4	13 140 C2I/53,9	15 300 C2I/53,1	25 330 C2I/52,1	30 690 C2I/53,1	39 920 C2I/51,3	49 900 C2I/51,3	60 020 C2I/50,5				
	50	160 ICI/49	285 ICI/50,9	335 ICI/50,9	545 ICI/53	630 ICI/53	1 250 ICI/49,9	2 440 ICI/50	3 090 ICI/49,3	5 610 ICI/52,5	6 830 ICI/50,8	11 150 ICI/52,5	-	-	-	-	-	-	-			
	45	-	-	-	-	-	-	-	3 750 C2I/45,1	6 150 C2I/45,6	7 940 C2I/45,4	12 650 C2I/46,6	15 880 C2I/47,8	23 710 C2I/47,1	31 320 C2I/47,5	39 700 C2I/44,2	49 400 C2I/44,2	62 640 C2I/45,4				
	40	-	-	-	-	-	-	-	3 660 C2I/38,7	5 640 C2I/39,5	7 600 C2I/41	11 990 C2I/42,6	16 110 C2I/41,4	23 000 C2I/42,8	31 770 C2I/41,6	40 270 C2I/39,5	50 110 C2I/39,5	63 530 C2I/41				
	40	175 ICI/38,6	290 ICI/40,1	360 ICI/40,1	600 ICI/41,8	695 ICI/41,8	1 450 ICI/39,4	2 510 ICI/39,4	2 910 ICI/40,2	5 980 ICI/41,4	6 440 ICI/41,6	12 140 ICI/41,4	-	-	-	-	-	-	-			
	35,5	-	-	-	-	-	-	-	3 860 C2I/37,5	5 720 C2I/37,5	8 170 C2I/37,3	11 620 C2I/35,3	16 020 C2I/36,2	23 330 C2I/37,2	32 220 C2I/37,5	40 850 C2I/36,3	50 830 C2I/36,3	64 450 C2I/37,3				
	31,5	-	-	-	-	-	-	-	34,8 C2I/32	58,7 C2I/33,1	78,7 C2I/33,2	113 C2I/34,2▲	140 C2I/33,7▲	-	-	-	-	-	-	31,5	2800	90
31,5	1,64 ICI/32,1	2,5 ICI/33	3,12 ICI/33	5,19 ICI/31,4	5,7 ICI/31,4	11,6 ICI/32,8	21,4 ICI/32,4	-	46,7 ICI/31,4	-	92,4 ICI/32,7	-	-	-	-	-	-	-	31,5	2800		

For n_1 lower than 560 min⁻¹ see page 195.

▲ Possible forced lubrication with heat exchanger: consult us.

9 - Selection tables (bevel helical gear reducers)

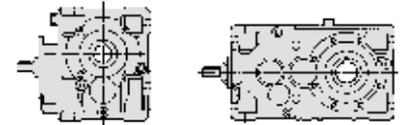

$n_{N2} \cdot L_h$ min ⁻¹ · h	i_N	P_{N2} kW																i_N	n_1 min ⁻¹	n_{N2} min ⁻¹		
		M_{N2} N m																				
		... / i																				
		50	63	64	80	81	100	125	140	160	180	200	225	250	280	320	321	360				
1 120 000	31,5	-	2,11 225 CI/31,3	2,34 250 CI/31,3	4,12 455 CI/32,5	5,13 570 CI/32,5	10 1 030 CI/30,1	18,7 2 000 CI/31,3	-	36,6 3 840 CI/30,8	-	68,8 7 220 CI/30,8	-	-	14 040 CI/31,7	-	-	-	-	31,5	2800	90
	28	-	-	-	-	-	-	-	36,3 3 970 C2I/28,6	65,2 7 200 C2I/28,9	76,3 8 400 C2I/28,8	119 13 450 C2I/29,5	145 16 800 C2I/30,3	-	-	-	-	-	28	2500		
	25	-	-	-	-	-	-	-	36 3 770 C2I/24,5	62,2 6 650 C2I/25,1	70,7 7 830 C2I/26	110 12 710 C2I/27	149 16 740 C2I/26,3	241 27 850 C2I/27,2▲	299 33 560 C2I/26,4▲	-	-	-	25	2240		
	25	1,44 150 CI/24,1	2,24 240 CI/25	2,83 300 CI/25	4,88 540 CI/26	5,56 615 CI/26	10,3 1 060 CI/24,1	21,5 2 290 CI/25	-	43,1 4 530 CI/24,6	-	84,8 8 890 CI/24,6	-	-	168 18 200 CI/25,4	-	-	-	-	25	2240	
	22,4	-	-	-	-	-	-	-	35,5 4 030 C2I/23,8	57,5 6 520 C2I/23,8	75,7 8 550 C2I/23,7	119 12 720 C2I/22,4	154 16 910 C2I/23	223 25 150 C2I/23,6	296 33 690 C2I/23,8	-	-	-	-	22,4	2000	
	20	-	-	-	-	-	-	-	32,9 3 570 C2I/20,4	55,5 6 060 C2I/20,6	70,2 7 960 C2I/21,4	113 12 290 C2I/20,5	140 14 840 C2I/19,9	217 24 720 C2I/21,5	277 30 560 C2I/20,8	396 43 270 C2I/20,6▲	492 53 710 C2I/20,6▲	553 62 670 C2I/21,4▲	20	1800		
	20	1,45 150 CI/19,3	2,44 260 CI/20	3 320 CI/20	5 550 CI/20,8	5,78 640 CI/20,8	11,8 1 200 CI/19,3	21,5 2 280 CI/20	30,9 3 280 CI/20	47,6 4 970 CI/19,7	60,9 6 560 CI/20,3	97,8 10 220 CI/19,7	122 13 120 CI/20,3	190 20 430 CI/20,3	244 25 920 CI/20	321 33 500 CI/19,7	428 44 700 CI/19,7	475 51 120 CI/20,3	20	1800		
	18	-	-	-	-	-	-	-	31,3 3 360 CI/18	49,3 5 300 CI/18	62,6 6 980 CI/18	98,2 10 550 CI/18	124 13 820 CI/18,7	197 20 980 CI/17,9	248 26 690 CI/18	300 32 270 CI/18	394 42 330 CI/18	493 54 130 CI/18,4	18	1600		
	16	1,43 150 CI/15,2	2,47 265 CI/15,8	3,03 325 CI/15,8	5,05 565 CI/16,4	5,83 650 CI/16,4	11,5 1 200 CI/15,2	23,5 2 520 CI/15,8	31,4 3 370 CI/15,8	50 5 300 CI/15,5	65,5 7 150 CI/16	103 10 920 CI/15,5	135 14 710 CI/16	190 20 790 CI/16	265 28 460 CI/15,8	305 33 880 CI/16,3	381 42 240 CI/16,3	497 54 220 CI/16	16	1400		
	14	-	-	-	-	-	-	-	32,9 3 560 CI/14,2	51,2 5 550 CI/14,2	65,7 7 390 CI/14,7	105 11 340 CI/14,2	131 14 770 CI/14,7	211 22 680 CI/14,1	259 28 070 CI/14,2	337 36 500 CI/14,2	399 43 300 CI/14,2	513 56 910 CI/14,5	14	1250		
	12,5	1,61 170 CI/12,4	2,76 295 CI/12,6	3,49 375 CI/12,6	5,86 655 CI/13,1	6,78 760 CI/13,1	12,3 1 300 CI/12,4	25,1 2 700 CI/12,6	29,7 3 260 CI/12,9	52,2 5 800 CI/13	59,5 6 650 CI/13,1	104 11 570 CI/13	125 13 710 CI/12,8	208 22 400 CI/12,6	234 25 690 CI/12,9	317 34 700 CI/12,8	389 42 500 CI/12,8	464 49 960 CI/12,6	12,5	1120		
	11,2	-	-	-	-	-	-	-	34,5 3 710 CI/11,3	47,1 5 130 CI/11,4	70,7 7 880 CI/11,7	93,9 10 100 CI/11,3	141 15 720 CI/11,7	188 20 450 CI/11,4	283 30 410 CI/11,3	335 35 310 CI/11	419 44 140 CI/11	525 57 660 CI/11,5	11,2	1000		
	10	1,53 170 CI/10,3	2,92 310 CI/10	3,58 380 CI/10	5,94 655 CI/10,4	6,87 760 CI/10,4	13 1 350 CI/9,81	25,4 2 700 CI/10	31,9 3 450 CI/10,2	50,2 5 500 CI/10,3	65,2 7 180 CI/10,4	110 12 010 CI/10,3	132 14 270 CI/10,2	206 21 880 CI/10	257 27 800 CI/10,2	362 39 050 CI/10,2	442 47 700 CI/10,2	509 54 020 CI/10	10	900		
	9	-	-	-	-	-	-	-	34,5 3 710 CI/9	51,9 5 600 CI/9,04	69 7 690 CI/9,33	109 11 610 CI/8,93	136 15 150 CI/9,33	206 22 270 CI/9,04	272 29 220 CI/9	364 38 040 CI/8,75	458 47 790 CI/8,75	525 57 660 CI/9,2	9	800		
8	1,66 175 CI/7,85	2,82 305 CI/8	3,53 380 CI/8	5,86 655 CI/8,33	6,78 760 CI/8,33	12,6 1 330 CI/7,85	25,3 2 720 CI/8	31,6 3 460 CI/8,15	49,6 5 510 CI/8,27	61,9 6 920 CI/8,31	110 12 250 CI/8,27	122 13 410 CI/8,14	185 20 440 CI/8,21	244 26 750 CI/8,15	326 34 370 CI/7,83	411 43 270 CI/7,83	482 51 910 CI/8	8	710			
6,3	1,47 165 CI/6,53	2,59 290 CI/6,57	3,24 365 CI/6,57	5,08 545 CI/6,27	6,58 705 CI/6,27	10 1 120 CI/6,53	24,1 2 700 CI/6,57	-	44,8 4 780 CI/6,27	-	93,3 10 400 CI/6,53	-	174 19 500 CI/6,57	-	310 33 170 CI/6,27	386 41 200 CI/6,27	-	6,3	560			
1 000 000	160	-	-	-	-	-	-	3 000 C2I/151	4 500 C2I/154	6 300 C2I/158	9 250 C2I/151	12 800 C2I/156	18 500 C2I/156	25 100 C2I/154	31 500 C2I/156	38 700 C2I/156	49 510 C2I/161					
	160	-	-	-	-	1 030 ICI/154	2 060 ICI/159	2 200 ICI/159	4 500 ICI/157	5 270 ICI/162	7 620 ICI/157	-	-	-	-	-	-					

For n_1 lower than 560 min⁻¹ see page 195.

▲ Possible forced lubrication with heat exchanger: consult us.

9 - Selection tables (bevel helical gear reducers)

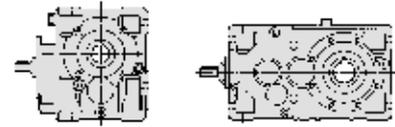

$n_{N2} \cdot L_h$ min ⁻¹ · h	i_N	P_{N2} kW																i_N	n_1	n_{N2}	
		M_{N2} N m																			
		... / i																			
		50	63	64	80	81	100	125	140	160	180	200	225	250	280	320	321	360			
1 000 000	125	-	-	-	-	-	-	-	2 940 C2I/123	5 600 C2I/129	6 660 C2I/130	11 200 C2I/127	12 910 C2I/125	19 320 C2I/123	22 710 C2I/125	33 960 C2I/129	42 450 C2I/129	45 230 C2I/127			
	125	-	-	-	-	-	1 090 ICI/123	2 180 ICI/127	2 690 ICI/127	4 750 ICI/126	6 700 ICI/130	9 750 ICI/126	-	-	-	-	-	-			
	100	-	-	-	-	-	-	-	3 220 C2I/98,2	5 800 C2I/103	7 060 C2I/104	11 800 C2I/102	13 690 C2I/100	20 500 C2I/98,5	26 980 C2I/100	36 840 C2I/103	46 050 C2I/103	53 960 C2I/102			
	100	-	220 ICI/99,4	270 ICI/99,4	485 ICI/103	530 ICI/103	1 250 ICI/100	2 300 ICI/102	2 780 ICI/100	5 690 ICI/106	6 500 ICI/102	11 190 ICI/106	-	-	-	-	-	-			
	90	-	-	-	-	-	-	-	3 410 C2I/87,8	5 730 C2I/90,4	6 740 C2I/90	11 200 C2I/87,9	14 460 C2I/90,3	20 650 C2I/89	28 530 C2I/89,7	36 160 C2I/88,8	45 000 C2I/88,8	57 050 C2I/91,4			
	80	-	-	-	-	-	-	-	3 400 C2I/78,6	6 030 C2I/82,7	7 220 C2I/83,1	11 980 C2I/81,4	14 430 C2I/80,2	20 620 C2I/78,8	28 460 C2I/80,3	36 050 C2I/82,6	44 540 C2I/82,6	56 910 C2I/81,2			
	80	150 ICI/75,2	235 ICI/79,5	295 ICI/79,5	520 ICI/82,7	615 ICI/82,7	1 190 ICI/76,7	2 060 ICI/78,1	2 490 ICI/78,1	4 370 ICI/78,1	5 000 ICI/80,5	8 990 ICI/78,1	-	-	-	-	-	-			
	71	-	-	-	-	-	-	-	3 600 C2I/70,2	5 460 C2I/72,3	7 020 C2I/72	10 850 C2I/70,3	15 250 C2I/72,2	21 780 C2I/71,2	30 080 C2I/71,7	38 140 C2I/71,1	47 460 C2I/71,1	60 170 C2I/73,1			
	63	-	-	-	-	-	-	-	3 540 C2I/62	6 500 C2I/65,2	8 950 C2I/65,5	13 170 C2I/64,2	16 060 C2I/63,2	26 420 C2I/62,1	31 670 C2I/63,3	44 320 C2I/65,1	55 400 C2I/65,1	59 270 C2I/64			
	63	150 ICI/60,1	235 ICI/63,6	295 ICI/63,6	520 ICI/66,2	615 ICI/66,2	1 280 ICI/61,3	2 520 ICI/62,5	3 050 ICI/62,5	5 560 ICI/62,5	6 670 ICI/64,4	11 230 ICI/62,5	-	-	-	-	-	-			
	56	-	-	-	-	-	-	-	3 700 C2I/55,4	6 700 C2I/57	7 920 C2I/56,8	13 600 C2I/55,5	15 660 C2I/56,9	27 020 C2I/56,1	30 880 C2I/56,6	39 370 C2I/56	49 210 C2I/56	61 760 C2I/57,6			
	50	-	-	-	-	-	-	-	3 630 C2I/50,4	6 640 C2I/52,1	7 850 C2I/52,4	13 190 C2I/53,9	15 850 C2I/53,1	26 240 C2I/52,1	31 790 C2I/53,1	41 360 C2I/51,3	51 690 C2I/51,3	60 870 C2I/50,5			
	50	160 ICI/49	285 ICI/50,9	335 ICI/50,9	555 ICI/53	655 ICI/53	1 250 ICI/49,9	2 470 ICI/50	3 130 ICI/49,3	5 690 ICI/52,5	7 080 ICI/50,8	11 190 ICI/52,5	-	-	-	-	-	-			
	45	-	-	-	-	-	-	-	3 800 C2I/45,1	6 370 C2I/45,6	8 050 C2I/45,4	13 110 C2I/46,6	16 110 C2I/47,8	24 580 C2I/47,1	31 770 C2I/47,5	40 270 C2I/44,2	50 110 C2I/44,2	63 530 C2I/45,4			
	40	-	-	-	-	-	-	-	3 710 C2I/38,7	5 720 C2I/39,5	7 710 C2I/41	12 430 C2I/42,6	16 340 C2I/41,4	23 330 C2I/42,8	32 220 C2I/41,6	40 850 C2I/39,5	50 830 C2I/39,5	64 450 C2I/41			
	40	175 ICI/38,6	290 ICI/40,1	365 ICI/40,1	610 ICI/41,8	705 ICI/41,8	1 500 ICI/39,4	2 540 ICI/39,4	2 950 ICI/40,2	6 200 ICI/41,4	6 530 ICI/41,6	12 470 ICI/41,4	-	-	-	-	-	-			
	35,5	-	-	-	-	-	-	-	30,6 C2I/37,5	45,4 C2I/37,5	65,1 C2I/37,3	97,9 C2I/35,3	131 C2I/36,2	186 C2I/37,2	255 C2I/37,5	-	-	-	35,5	2800	80
	31,5	-	-	-	-	-	-	-	31,5 C2I/32	52,6 C2I/33,1	70,5 C2I/33,2	101 C2I/34,2	127 C2I/33,7	-	-	-	-	-	31,5	2500	

For n_1 lower than 560 min⁻¹ see page 195.

9 - Selection tables (bevel helical gear reducers)

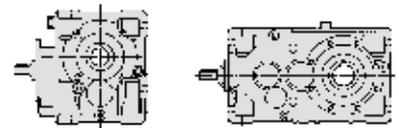

$n_{N2} \cdot L_h$ min ⁻¹ · h	i_N	P_{N2} kW																i_N	n_1	n_{N2} min ⁻¹		
		M_{N2} N m																				
		... / i																				
		50	63	64	80	81	100	125	140	160	180	200	225	250	280	320	321	360				
1 000 000	31,5	1,5 185 ICI/32,1	2,31 290 ICI/33	2,89 365 ICI/33	4,7 565 ICI/31,4	5,16 620 ICI/31,4	10,7 1 340 ICI/32,8	19,4 2 400 ICI/32,4	-	42,3 5 070 ICI/31,4	-	85,3 10 660 ICI/32,7	-	-	-	-	-	-	-	31,5	2500	80
	31,5	-	1,89 225 CI/31,3	2,1 250 CI/31,3	3,69 460 CI/32,5	4,59 570 CI/32,5	8,97 1 030 CI/30,1	16,8 2 010 CI/31,3	-	32,8 3 860 CI/30,8	-	63,6 7 470 CI/30,8	-	14 530 CI/31,7	-	-	-	-	-	31,5	2500	
	28	-	-	-	-	-	-	-	33 4 020 C2I/28,6	58,6 7 230 C2I/28,9	69,3 8 510 C2I/28,8	110 13 900 C2I/29,5	132 17 020 C2I/30,3	212 27 070 C2I/29,9▲	261 33 560 C2I/30,1▲	-	-	-	-	28	2240	
	25	-	-	-	-	-	-	-	32,6 3 820 C2I/24,5	57,5 6 880 C2I/25,1	64 7 940 C2I/26	102 13 150 C2I/27	135 16 960 C2I/26,3	219 28 350 C2I/27,2	270 34 020 C2I/26,4	-	-	-	-	25	2000	
	25	1,29 150 CI/24,1	2,03 240 CI/25	2,56 305 CI/25	4,42 550 CI/26	5,03 625 CI/26	9,23 1 060 CI/24,1	19,8 2 370 CI/25	-	39,8 4 680 CI/24,6	-	76,7 9 020 CI/24,6	-	152 18 450 CI/25,4	-	-	-	-	-	25	2000	
	22,4	-	-	-	-	-	-	-	32,3 4 080 C2I/23,8	53,4 6 730 C2I/23,8	69 8 650 C2I/23,7	111 13 130 C2I/22,4	140 17 130 C2I/23	207 25 950 C2I/23,6	270 34 120 C2I/23,8	355 43 270 C2I/23▲	441 53 870 C2I/23▲	544 68 260 C2I/23,7▲	-	22,4	1800	
	20	-	-	-	-	-	-	-	29,7 3 620 C2I/20,4	50 6 140 C2I/20,6	63,3 8 070 C2I/21,4	102 12 460 C2I/20,5	127 15 050 C2I/19,9	196 25 070 C2I/21,5	249 30 990 C2I/20,8	357 43 880 C2I/20,6	443 54 470 C2I/20,6	499 63 560 C2I/21,4	-	20	1600	
	20	1,29 150 CI/19,3	2,2 265 CI/20	2,71 325 CI/20	4,51 560 CI/20,8	5,21 645 CI/20,8	10,8 1 250 CI/19,3	19,4 2 310 CI/20	27,9 3 330 CI/20	42,9 5 040 CI/19,7	54,9 6 650 CI/20,3	88,1 10 360 CI/19,7	110 13 300 CI/20,3	171 20 720 CI/20,3	220 26 280 CI/20	289 33 970 CI/19,7	394 46 310 CI/19,7	428 51 850 CI/20,3	-	20	1600	
	18	-	-	-	-	-	-	-	27,8 3 420 CI/18	43,8 5 380 CI/18	55,7 7 090 CI/18,7	87,3 10 720 CI/18	110 14 000 CI/18,7	175 21 320 CI/17,9	221 27 120 CI/18	267 32 790 CI/18	359 44 060 CI/18	434 54 500 CI/18,4	-	18	1400	
	16	1,28 150 CI/15,2	2,21 265 CI/15,8	2,72 325 CI/15,8	4,52 565 CI/16,4	5,22 655 CI/16,4	10,7 1 240 CI/15,2	21 2 530 CI/15,8	28,3 3 420 CI/15,8	46,2 5 480 CI/15,5	58,9 7 190 CI/16	94,6 11 230 CI/15,5	125 15 220 CI/16	172 21 000 CI/16	238 28 650 CI/15,8	275 34 200 CI/16,3	343 42 640 CI/16,3	446 54 490 CI/16	-	16	1250	
	14	-	-	-	-	-	-	-	29,7 3 600 CI/14,2	46,1 5 580 CI/14,2	59,5 7 470 CI/14,7	94,2 11 400 CI/14,2	122 15 270 CI/14,7	190 22 800 CI/14,1	234 28 360 CI/14,2	304 36 850 CI/14,2	361 43 700 CI/14,2	464 57 450 CI/14,5	-	14	1120	
	12,5	1,48 175 CI/12,4	2,48 300 CI/12,6	3,13 375 CI/12,6	5,25 660 CI/13,1	6,08 765 CI/13,1	11,1 1 310 CI/12,4	22,6 2 720 CI/12,6	26,8 3 290 CI/12,9	47,1 5 870 CI/13	53,7 6 710 CI/13,1	93,9 11 690 CI/13	112 13 750 CI/12,8	188 22 620 CI/12,6	211 25 950 CI/12,9	286 35 030 CI/12,8	350 42 910 CI/12,8	419 50 440 CI/12,6	-	12,5	1000	
11,2	-	-	-	-	-	-	-	31,2 3 730 CI/11,3	42,9 5 190 CI/11,4	64 7 930 CI/11,7	85,3 10 190 CI/11,3	128 15 820 CI/11,7	171 20 640 CI/11,4	257 30 680 CI/11,3	304 35 630 CI/11	380 44 530 CI/11	477 58 180 CI/11,5	-	11,2	900		
10	1,41 175 CI/10,3	2,6 310 CI/10	3,19 380 CI/10	5,3 660 CI/10,4	6,13 760 CI/10,4	11,6 1 360 CI/9,81	23,2 2 770 CI/10	28,4 3 450 CI/10,2	45,1 5 560 CI/10,3	58,5 7 250 CI/10,4	101 12 440 CI/10,3	117 14 270 CI/10,2	185 22 080 CI/10	231 28 070 CI/10,2	325 39 450 CI/10,2	397 48 150 CI/10,2	458 54 620 CI/10	-	10	800		
9	-	-	-	-	-	-	-	31,6 3 820 CI/9	46,6 5 670 CI/9,04	61,9 7 770 CI/9,33	100 12 030 CI/8,93	122 15 370 CI/9,33	185 22 490 CI/9,04	244 29 530 CI/9	326 38 390 CI/8,75	411 48 330 CI/8,75	471 58 250 CI/9,2	-	9	710		
8	1,47 175 CI/7,85	2,52 305 CI/8	3,14 380 CI/8	5,22 660 CI/8,33	6,04 765 CI/8,33	11,2 1 330 CI/7,85	23,3 2 820 CI/8	29 3 590 CI/8,15	44,4 5 570 CI/8,27	55,5 6 990 CI/8,31	101 12 700 CI/8,27	113 13 900 CI/8,14	166 20 630 CI/8,21	219 27 030 CI/8,15	292 34 690 CI/7,83	368 43 750 CI/7,83	432 52 420 CI/8	-	8	630		
900 000	200	-	-	-	-	775 ICI/192	1 850 ICI/199	-	3 650 ICI/196	-	7 150 ICI/196	-	-	-	-	-	-	-	-	-	-	-
	160	-	-	-	-	-	-	3 150 C2I/151	4 620 C2I/154	6 500 C2I/158	9 500 C2I/151	13 200 C2I/156	19 000 C2I/156	25 940 C2I/154	32 500 C2I/156	40 000 C2I/156	51 160 C2I/161	-	-	-	-	

For n_1 lower than 560 min⁻¹ see page 195.

▲ Possible forced lubrication with heat exchanger: consult us.

9 - Selection tables (bevel helical gear reducers)

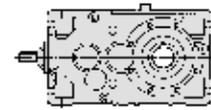
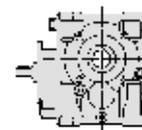

$n_{N2} \cdot L_h$ min ⁻¹ · h	i_N	P_{N2} kW M_{N2} N m ... / i																i_N	n_1 min ⁻¹	n_{N2} min ⁻¹	
		50	63	64	80	81	100	125	140	160	180	200	225	250	280	320	321				360
		900 000	160	-	-	-	-	-	1 060 ICI/154	2 120 ICI/159	2 270 ICI/159	4 700 ICI/157	5 420 ICI/162	7 830 ICI/157	-	-	-				-
	125	-	-	-	-	-	-	-	3 040 C2I/123	5 600 C2I/129	6 880 C2I/130	11 500 C2I/127	13 320 C2I/125	19 940 C2I/123	23 360 C2I/125	35 050 C2I/129	43 810 C2I/129	46 520 C2I/127			
	125	-	-	-	-	-	1 120 ICI/123	2 240 ICI/127	2 770 ICI/127	4 870 ICI/126	6 910 ICI/130	10 000 ICI/126	-	-	-	-	-	-			
	100	-	-	-	-	-	-	-	3 310 C2I/98,2	6 000 C2I/103	7 320 C2I/104	12 200 C2I/102	14 190 C2I/100	21 250 C2I/98,5	27 720 C2I/100	38 180 C2I/103	47 730 C2I/103	55 440 C2I/102			
	100	-	225 ICI/99,4	280 ICI/99,4	485 ICI/103	545 ICI/103	1 260 ICI/100	2 380 ICI/102	2 850 ICI/100	5 710 ICI/106	6 700 ICI/102	11 230 ICI/106	-	-	-	-	-	-			
	90	-	-	-	-	-	-	-	3 510 C2I/87,8	5 940 C2I/90,4	6 910 C2I/90	11 610 C2I/87,9	14 850 C2I/90,3	21 200 C2I/89	29 280 C2I/89,7	37 120 C2I/88,8	46 190 C2I/88,8	58 560 C2I/91,4			
	80	-	-	-	-	-	-	-	3 490 C2I/78,6	6 240 C2I/82,7	7 420 C2I/83,1	12 410 C2I/81,4	14 830 C2I/80,2	21 190 C2I/78,8	29 240 C2I/80,3	37 030 C2I/82,6	46 140 C2I/82,6	58 470 C2I/81,2			
	80	150 ICI/75,2	235 ICI/79,5	295 ICI/79,5	525 ICI/82,7	615 ICI/82,7	1 190 ICI/76,7	2 140 ICI/78,1	2 550 ICI/78,1	4 490 ICI/78,1	5 140 ICI/80,5	9 240 ICI/78,1	-	-	-	-	-	-			
	71	-	-	-	-	-	-	-	3 650 C2I/70,2	5 650 C2I/72,3	7 120 C2I/72	11 090 C2I/70,3	15 460 C2I/72,2	22 080 C2I/71,2	30 490 C2I/71,7	38 660 C2I/71,1	48 100 C2I/71,1	60 990 C2I/73,1			
	63	-	-	-	-	-	-	-	3 580 C2I/62	6 660 C2I/65,2	8 980 C2I/65,5	13 210 C2I/64,2	16 580 C2I/63,2	26 510 C2I/62,1	32 690 C2I/63,3	45 720 C2I/65,1	57 150 C2I/65,1	60 020 C2I/64			
	63	150 ICI/60,1	235 ICI/63,6	295 ICI/63,6	525 ICI/66,2	615 ICI/66,2	1 280 ICI/61,3	2 540 ICI/62,5	3 090 ICI/62,5	5 580 ICI/62,5	6 880 ICI/64,4	11 270 ICI/62,5	-	-	-	-	-	-			
	56	-	-	-	-	-	-	-	3 750 C2I/55,4	6 700 C2I/57	7 950 C2I/56,8	14 050 C2I/55,5	15 880 C2I/56,9	27 120 C2I/56,1	31 320 C2I/56,6	40 780 C2I/56	50 980 C2I/56	62 640 C2I/57,6			
	50	-	-	-	-	-	-	-	3 690 C2I/50,4	6 660 C2I/52,1	8 130 C2I/52,4	13 240 C2I/53,9	16 430 C2I/53,1	26 560 C2I/52,1	32 950 C2I/53,1	42 860 C2I/51,3	53 580 C2I/51,3	61 750 C2I/50,5			
	50	160 ICI/49	285 ICI/50,9	335 ICI/50,9	575 ICI/53	680 ICI/53	1 260 ICI/49,9	2 510 ICI/50	3 180 ICI/49,3	5 710 ICI/52,5	7 340 ICI/50,8	11 230 ICI/52,5	-	-	-	-	-	-			
	45	-	-	-	-	-	-	-	3 860 C2I/45,1	6 600 C2I/45,6	8 170 C2I/45,4	13 590 C2I/46,6	16 340 C2I/47,8	25 480 C2I/47,1	32 220 C2I/47,5	40 850 C2I/44,2	50 830 C2I/44,2	64 450 C2I/45,4			
	40	-	-	-	-	-	-	-	28,5 C2I/38,7	44 C2I/39,5	55,9 C2I/41	88,7 C2I/42,6	117 C2I/41,4	164 C2I/42,8	231 C2I/41,6	-	-	-	40	2800	71
	40	1,34 ICI/38,6	2,13 ICI/40,1	2,66 ICI/40,1	4,32 ICI/41,8	5 ICI/41,8	11,6 ICI/39,4	19,2 ICI/39,4	21,8 ICI/40,2	45,5 ICI/41,4	46,7 ICI/41,6	88,7 ICI/41,4	-	-	-	-	-	40	2800		
	35,5	-	-	-	-	-	-	-	27,7 C2I/37,5	41,1 C2I/37,5	58,9 C2I/37,3	88,6 C2I/35,3	119 C2I/36,2	169 C2I/37,2	231 C2I/37,5	-	-	-	35,5	2500	

For n_1 lower than 560 min⁻¹ see page 195.

▲ Possible forced lubrication with heat exchanger: consult us.

9 - Selection tables (bevel helical gear reducers)

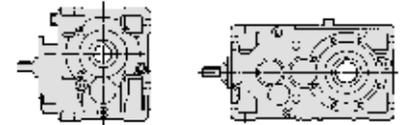

$n_{N2} \cdot L_h$ min ⁻¹ · h	i_N	P_{N2} kW																i_N	n_1	n_{N2} min ⁻¹		
		M_{N2} N m																				
		... / i																				
		50	63	64	80	81	100	125	140	160	180	200	225	250	280	320	321	360				
900 000	31,5	-	-	-	-	-	-	-	28,6 3 900 C2I/32	47,3 6 660 C2I/33,1	63,4 8 980 C2I/33,2	90,9 13 240 C2I/34,2	115 16 550 C2I/33,7	188 26 560 C2I/33,1▲	240 34 430 C2I/33,7▲	318 42 540 C2I/31,3▲	396 52 940 C2I/31,3▲	484 67 130 C2I/32,5▲	31,5	2240	71	
	31,5	1,35 185 ICI/32,1	2,14 300 ICI/33	2,67 375 ICI/33	4,26 570 ICI/31,4	4,68 625 ICI/31,4	9,89 1 380 ICI/32,8	17,6 2 430 ICI/32,4	-	38,4 5 130 ICI/31,4	-	79 11 010 ICI/32,7	-	-	-	-	-	-	-	31,5	2240	
	31,5	-	1,7 225 CI/31,3	1,89 250 CI/31,3	3,32 460 CI/32,5	4,13 570 CI/32,5	8,07 1 040 CI/30,1	15,1 2 010 CI/31,3	-	29,5 3 870 CI/30,8	-	58,9 7 720 CI/30,8	-	111 15 020 CI/31,7	-	-	-	-	-	31,5	2240	
	28	-	-	-	-	-	-	-	29,8 4 070 C2I/28,6	52,5 7 250 C2I/28,9	63,8 8 780 C2I/28,8	99,9 14 080 C2I/29,5	119 17 250 C2I/30,3	190 27 170 C2I/29,9	237 34 020 C2I/30,1	-	-	-	-	28	2000	
	25	-	-	-	-	-	-	-	29,7 3 870 C2I/24,5	53,4 7 100 C2I/25,1	59,3 8 180 C2I/26	94,7 13 570 C2I/27	123 17 180 C2I/26,3	197 28 440 C2I/27,2	246 34 450 C2I/26,4	328 43 670 C2I/25,1▲	409 54 340 C2I/25,1▲	499 68 900 C2I/26▲	25	1800		
	25	1,16 150 CI/24,1	1,85 245 CI/25	2,33 310 CI/25	4,03 555 CI/26	4,59 635 CI/26	8,34 1 070 CI/24,1	18,4 2 440 CI/25	-	36 4 700 CI/24,6	-	69,9 9 130 CI/24,6	-	139 18 690 CI/25,4	-	-	-	-	-	25	1800	
	22,4	-	-	-	-	-	-	-	29,2 4 140 C2I/23,8	49,2 6 970 C2I/23,8	62,2 8 780 C2I/23,7	102 13 600 C2I/22,4	127 17 370 C2I/23	191 26 890 C2I/23,6	244 34 600 C2I/23,8	320 43 880 C2I/23	398 54 630 C2I/23	490 69 230 C2I/23,7	22,4	1600		
	20	-	-	-	-	-	-	-	26,4 3 680 C2I/20,4	44,8 6 290 C2I/20,6	56,3 8 200 C2I/21,4	92,7 12 950 C2I/20,5	113 15 290 C2I/19,9	174 25 470 C2I/21,5	222 31 490 C2I/20,6	317 44 590 C2I/20,6	394 55 350 C2I/20,6	443 64 580 C2I/21,4	20	1400		
	20	1,13 150 CI/19,3	1,96 265 CI/20	2,41 330 CI/20	4,01 570 CI/20,8	4,63 655 CI/20,8	9,86 1 300 CI/19,3	17,2 2 350 CI/20	24,8 3 380 CI/20	38,6 5 190 CI/19,7	48,8 6 760 CI/20,3	78,4 10 530 CI/19,7	97,7 13 520 CI/20,3	152 21 050 CI/20,3	196 26 710 CI/20	257 34 520 CI/19,7	356 47 790 CI/19,7	388 53 640 CI/20,3	20	1400		
	18	-	-	-	-	-	-	-	24,9 3 420 CI/18	39,5 5 430 CI/18	49,7 7 090 CI/18,7	78,7 10 820 CI/18	98,2 14 000 CI/18,7	158 21 530 CI/17,9	197 27 120 CI/18	241 33 100 CI/18	331 45 580 CI/18	388 54 500 CI/18,4	18	1250		
	16	1,15 150 CI/15,2	1,99 265 CI/15,8	2,44 330 CI/15,8	4,06 570 CI/16,4	4,7 655 CI/16,4	9,86 1 280 CI/15,2	18,9 2 540 CI/15,8	26,3 3 530 CI/15,8	42,2 5 580 CI/15,5	53 7 230 CI/16	85,1 11 260 CI/15,5	115 15 730 CI/16	159 21 710 CI/16	214 28 840 CI/15,8	249 34 520 CI/16,3	310 43 020 CI/16,3	401 54 750 CI/16	16	1120		
	14	-	-	-	-	-	-	-	26,8 3 640 CI/14,2	41,5 5 630 CI/14,2	53,7 7 540 CI/14,7	84,6 11 470 CI/14,2	112 15 770 CI/14,7	170 22 940 CI/14,1	211 28 650 CI/14,2	275 37 210 CI/14,2	325 44 110 CI/14,2	419 58 010 CI/14,5	14	1000		
	12,5	1,34 175 CI/12,4	2,24 300 CI/12,6	2,83 380 CI/12,6	4,74 660 CI/13,1	5,49 765 CI/13,1	10 1 310 CI/12,4	20,4 2 730 CI/12,6	24,4 3 320 CI/12,9	42,9 5 930 CI/13	48,7 6 780 CI/13,1	85,3 11 800 CI/13	101 13 800 CI/12,8	171 22 840 CI/12,6	192 26 200 CI/12,9	260 35 340 CI/12,8	318 43 300 CI/12,8	383 51 310 CI/12,6	12,5	900		
	11,2	-	-	-	-	-	-	-	27,9 3 750 CI/11,3	38,6 5 250 CI/11,4	57,3 7 980 CI/11,7	76,6 10 300 CI/11,3	116 16 200 CI/11,7	153 20 850 CI/11,4	231 30 990 CI/11,3	273 35 980 CI/11	341 44 970 CI/11	428 58 760 CI/11,5	11,2	800		
	10	1,3 180 CI/10,3	2,32 310 CI/10	2,84 380 CI/10	4,72 660 CI/10,4	5,46 765 CI/10,4	10,4 1 370 CI/9,81	21,4 2 870 CI/10	25,2 3 450 CI/10,2	40,4 5 610 CI/10,3	52,4 7 320 CI/10,4	92,8 12 900 CI/10,3	104 14 270 CI/10,2	166 22 290 CI/10	207 28 350 CI/10,2	291 39 850 CI/10,2	355 48 600 CI/10,2	411 55 240 CI/10	10	710		
	9	-	-	-	-	-	-	-	29 3 960 CI/9	41,8 5 730 CI/9,04	55,5 7 850 CI/9,33	92,1 12 470 CI/8,93	113 15 930 CI/9,33	166 22 700 CI/9,04	219 29 840 CI/9	292 38 750 CI/8,75	368 48 870 CI/8,75	422 58 840 CI/9,2	9	630		
8	1,31 175 CI/7,85	2,25 305 CI/8	2,8 380 CI/8	4,65 660 CI/8,33	5,39 765 CI/8,33	10 1 340 CI/7,85	21,4 2 920 CI/8	26,7 3 720 CI/8,15	39,7 5 600 CI/8,27	49,8 7 060 CI/8,31	93,3 13 160 CI/8,27	104 14 400 CI/8,14	149 20 830 CI/8,21	196 27 200 CI/8,15	262 35 010 CI/7,83	331 44 220 CI/7,83	388 52 930 CI/8	8	560			
800 000	200	-	-	-	-	800 ICI/192	1 900 ICI/199	-	3 750 ICI/196	-	7 400 ICI/196	-	-	-	-	-	-	-				

For n_1 lower than 560 min⁻¹ see page 195.

▲ Possible forced lubrication with heat exchanger: consult us.

9 - Selection tables (bevel helical gear reducers)

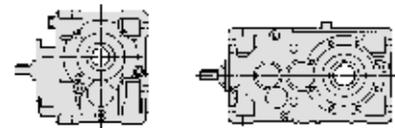

$n_{N2} \cdot L_h$ min ⁻¹ · h	i_N	P_{N2} kW M_{N2} N m ... / i																i_N	n_1 min ⁻¹	n_{N2} min ⁻¹	
		50	63	64	80	81	100	125	140	160	180	200	225	250	280	320	321				360
800 000	160	-	-	-	-	-	-	-	3 150 C2I/151	4 750 C2I/154	6 700 C2I/158	9 750 C2I/151	13 600 C2I/156	19 500 C2I/156	26 840 C2I/154	33 500 C2I/156	40 000 C2I/156	52 930 C2I/161			
	160	-	-	-	-	-	1 090 ICI/154	2 180 ICI/159	2 350 ICI/159	4 720 ICI/157	5 440 ICI/162	8 030 ICI/157	-	-	-	-	-	-			
	125	-	-	-	-	-	-	-	3 150 C2I/123	5 800 C2I/129	7 120 C2I/130	11 800 C2I/127	13 800 C2I/125	20 660 C2I/123	24 110 C2I/125	36 310 C2I/129	45 380 C2I/129	48 030 C2I/127			
	125	-	-	-	-	-	1 150 ICI/123	2 300 ICI/127	2 870 ICI/127	5 000 ICI/126	6 990 ICI/130	10 300 ICI/126	-	-	-	-	-	-			
	100	-	-	-	-	-	-	-	3 400 C2I/98,2	6 150 C2I/103	7 590 C2I/104	12 500 C2I/102	14 710 C2I/100	22 030 C2I/98,5	28 460 C2I/100	39 580 C2I/103	49 470 C2I/103	56 910 C2I/102			
	100	-	235 ICI/99,4	285 ICI/99,4	490 ICI/103	560 ICI/103	1 260 ICI/100	2 470 ICI/102	2 950 ICI/100	5 740 ICI/106	6 900 ICI/102	11 280 ICI/106	-	-	-	-	-	-			
	90	-	-	-	-	-	-	-	3 600 C2I/87,8	6 160 C2I/90,4	7 100 C2I/90	12 030 C2I/87,9	15 250 C2I/90,3	21 780 C2I/89	30 080 C2I/89,7	38 140 C2I/88,8	47 460 C2I/88,8	60 170 C2I/91,4			
	80	-	-	-	-	-	-	-	3 540 C2I/78,6	6 460 C2I/82,7	7 520 C2I/83,1	12 830 C2I/81,4	15 030 C2I/80,2	21 480 C2I/78,8	29 640 C2I/80,3	38 190 C2I/82,6	47 740 C2I/82,6	59 270 C2I/81,2			
	80	150 ICI/75,2	240 ICI/79,5	295 ICI/79,5	525 ICI/82,7	620 ICI/82,7	1 200 ICI/76,7	2 210 ICI/78,1	2 590 ICI/78,1	4 550 ICI/78,1	5 210 ICI/80,5	9 360 ICI/78,1	-	-	-	-	-	-			
	71	-	-	-	-	-	-	-	3 700 C2I/70,2	5 830 C2I/72,3	7 210 C2I/72	11 450 C2I/70,3	15 660 C2I/72,2	22 360 C2I/71,2	30 880 C2I/71,7	39 140 C2I/71,1	48 710 C2I/71,1	61 760 C2I/73,1			
	63	-	-	-	-	-	-	-	3 630 C2I/62	6 690 C2I/65,2	9 010 C2I/65,5	13 260 C2I/64,2	17 170 C2I/63,2	26 610 C2I/62,1	33 870 C2I/63,3	45 890 C2I/65,1	57 360 C2I/65,1	60 870 C2I/64			
	63	150 ICI/60,1	240 ICI/63,6	295 ICI/63,6	525 ICI/66,2	620 ICI/66,2	1 340 ICI/61,3	2 550 ICI/62,5	3 130 ICI/62,5	5 600 ICI/62,5	6 980 ICI/64,4	11 310 ICI/62,5	-	-	-	-	-	-			
	56	-	-	-	-	-	-	-	3 800 C2I/55,4	6 900 C2I/57	7 980 C2I/56,8	14 100 C2I/55,5	16 110 C2I/56,9	27 220 C2I/56,1	31 770 C2I/56,6	42 270 C2I/56	52 840 C2I/56	63 530 C2I/57,6			
	50	-	-	-	-	-	-	-	3 740 C2I/50,4	6 690 C2I/52,1	8 430 C2I/52,4	13 290 C2I/53,9	17 030 C2I/53,1	26 660 C2I/52,1	34 150 C2I/53,1	44 430 C2I/51,3	55 540 C2I/51,3	62 630 C2I/50,5			
	50	160 ICI/49	285 ICI/50,9	335 ICI/50,9	595 ICI/53	685 ICI/53	1 260 ICI/49,9	2 540 ICI/50	3 220 ICI/49,3	5 740 ICI/52,5	7 600 ICI/50,8	11 280 ICI/52,5	-	-	-	-	-	-			
	45	-	-	-	-	-	-	-	25,5 C2I/45,1	44 C2I/45,6	53,5 C2I/45,4	88,7 C2I/46,6	102 C2I/47,8	164 C2I/47,1	202 C2I/47,5	32 680 C2I/44,2	41 430 C2I/44,2	51 550 C2I/44,2	65 360 C2I/45,4	45	2800
40	-	-	-	-	-	-	-	25,8 C2I/38,7	40,6 C2I/39,5	50,6 C2I/41	81,9 C2I/42,6	106 C2I/41,4	152 C2I/42,8	209 C2I/41,6	-	-	-	-	40	2500	
40	1,2 ICI/38,6	1,92 ICI/40,1	2,39 ICI/40,1	3,91 ICI/41,8	4,53 ICI/41,8	10,4 ICI/39,4	17,3 ICI/39,4	19,8 ICI/40,2	42 ICI/41,4	42,3 ICI/41,6	79,5 ICI/41,4	-	-	-	-	-	-	40	2500		

For n_1 lower than 560 min⁻¹ see page 195.

9 - Selection tables (bevel helical gear reducers)

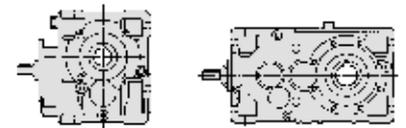

$n_{N2} \cdot L_h$ min ⁻¹ · h	i_N	P_{N2} kW																i_N	n_1	n_{N2} min ⁻¹		
		M_{N2} N m																				
		... / i																				
		50	63	64	80	81	100	125	140	160	180	200	225	250	280	320	321	360				
800 000	35,5	-	-	-	-	-	-	-	25,1 4 020	37,6 6 010	53,5 8 510	80,4 12 100	108 16 680	153 24 300	210 33 560	275 42 540	342 52 940	422 67 130	35,5	2240	63	
	31,5	-	-	-	-	-	-	-	25,8 3 950	42,4 6 690	56,8 9 010	81,4 13 290	104 16 770	169 26 660	215 34 550	288 43 120	359 53 670	438 68 040	31,5	2000		
	31,5	1,21 185	1,97 310	2,43 380	3,86 580	4,24 635	9,13 1 430	15,9 2 460	-	34,7 5 200	-	71,7 11 200	-	-	-	-	-	-	31,5	2000		
	31,5	-	1,52 225	1,69 250	2,97 460	3,7 575	7,23 1 040	13,5 2 020	-	26,4 3 880	-	54 7 930	-	103 15 530	-	-	-	-	31,5	2000		
	28	-	-	-	-	-	-	-	-	27,2 4 120	47,4 7 280	59,3 9 060	90,2 14 120	109 17 470	172 27 260	216 34 450	294 43 670	366 54 340	451 68 900	28	1800	
	25	-	-	-	-	-	-	-	-	26,8 3 920	49,2 7 350	54,6 8 480	87,2 14 060	111 17 420	176 28 550	222 34 940	296 44 290	368 55 110	450 69 880	25	1600	
	25	1,04 150	1,66 250	2,1 315	3,63 565	4,14 640	7,44 1 070	16,4 2 450	-	32,1 4 710	-	63 9 260	-	125 18 950	-	-	-	-	25	1600		
	22,4	-	-	-	-	-	-	-	-	25,9 4 210	44,8 7 250	55,3 8 920	92,4 14 110	113 17 650	169 27 280	217 35 160	284 44 590	354 55 510	436 70 340	22,4	1400	
	20	-	-	-	-	-	-	-	-	23,7 3 700	41,4 6 500	50,8 8 290	85,7 13 400	102 15 450	160 26 310	200 31 820	285 44 870	355 55 840	400 65 260	20	1250	
	20	1,02 150	1,75 270	2,16 330	3,59 570	4,15 660	9,1 1 340	15,8 2 420	22,4 3 420	35,7 5 370	44,1 6 840	70,4 10 590	88,2 13 660	137 21 180	177 26 990	231 34 690	319 47 960	358 55 500	20	1250		
	18	-	-	-	-	-	-	-	-	22,3 3 420	35,7 5 480	44,5 7 090	71,2 10 920	88 14 000	143 21 730	177 27 120	218 33 400	307 47 110	347 54 500	18	1120	
	16	1,03 150	1,78 270	2,19 330	3,64 570	4,21 660	9,11 1 320	16,9 2 550	23,8 3 580	37,8 5 600	47,7 7 280	76,2 11 300	107 16 270	147 22 460	193 29 030	224 34 850	284 44 040	368 56 270	16	1000		
	14	-	-	-	-	-	-	-	-	24,4 3 670	38,6 5 810	48,7 7 610	76,6 11 530	101 15 820	154 23 060	192 28 920	249 37 540	297 44 680	380 58 530	14	900	
	12,5	1,2 175	2,01 300	2,53 380	4,23 665	4,89 765	8,93 1 320	18,7 2 810	21,9 3 360	38,6 6 000	43,8 6 850	76,6 11 920	90,4 13 850	153 23 070	172 26 470	233 35 680	286 43 720	353 53 160	12,5	800		
	11,2	-	-	-	-	-	-	-	-	25 3 780	34,6 5 310	51,2 8 040	68,7 10 410	104 16 360	137 21 070	207 31 290	245 36 340	306 45 420	384 59 350	11,2	710	
10	1,18 185	2,06 315	2,53 385	4,2 665	4,86 770	9,25 1 380	19,6 2 970	22,3 3 450	36,7 5 750	47 7 390	84,3 13 200	92,6 14 300	148 22 500	185 28 630	261 40 250	318 49 060	368 55 850	10	630			
9	-	-	-	-	-	-	-	-	26,1 4 000	37,5 5 790	49,8 7 930	82,1 12 500	104 16 500	149 22 910	196 30 140	262 39 110	331 49 400	379 59 420	9	560		
710 000	200	-	-	-	-	825 ICI/192	1 950 ICI/199	-	3 750 ICI/196	-	7 650 ICI/196	-	-	-	-	-	-	-				

For n_1 lower than 560 min⁻¹ see page 195.

▲ Possible forced lubrication with heat exchanger: consult us.

9 - Selection tables (bevel helical gear reducers)

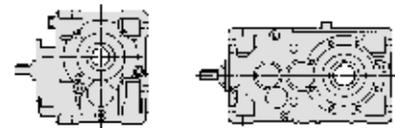

$n_{N2} \cdot L_h$ min ⁻¹ · h	i_N	P_{N2} kW																i_N	n_1	n_{N2}		
		M_{N2} N m																				
		... / i																				
		50	63	64	80	81	100	125	140	160	180	200	225	250	280	320	321	360				
710 000	160	-	-	-	-	-	-	-	3 250 C2I/151	4 870 C2I/154	6 900 C2I/158	10 000 C2I/151	14 000 C2I/156	20 000 C2I/156	27 700 C2I/154	34 500 C2I/156	41 200 C2I/156	54 630 C2I/161				
	160	-	-	-	-	-	1 120 ICI/154	2 240 ICI/159	2 420 ICI/159	4 730 ICI/157	5 460 ICI/162	8 260 ICI/157	-	-	-	-	-	-				
	125	-	-	-	-	-	-	-	3 260 C2I/123	6 000 C2I/129	7 380 C2I/130	12 200 C2I/127	14 300 C2I/125	21 410 C2I/123	24 770 C2I/125	37 630 C2I/129	47 040 C2I/129	49 340 C2I/127				
	125	-	-	-	-	-	1 180 ICI/123	2 360 ICI/127	2 980 ICI/127	5 150 ICI/126	7 010 ICI/130	10 600 ICI/126	-	-	-	-	-	-	-			
	100	-	-	-	-	-	-	-	3 490 C2I/98,2	6 300 C2I/103	7 860 C2I/104	12 800 C2I/102	15 240 C2I/100	22 820 C2I/98,5	29 240 C2I/100	41 000 C2I/103	51 250 C2I/103	58 470 C2I/102				
	100	-	240 ICI/99,4	285 ICI/99,4	490 ICI/103	575 ICI/103	1 270 ICI/100	2 560 ICI/102	3 060 ICI/100	5 760 ICI/106	7 100 ICI/102	11 320 ICI/106	-	-	-	-	-	-	-			
	90	-	-	-	-	-	-	-	3 650 C2I/87,8	6 370 C2I/90,4	7 200 C2I/90	12 450 C2I/87,9	15 460 C2I/90,3	22 080 C2I/89	30 490 C2I/89,7	38 660 C2I/88,8	48 100 C2I/88,8	60 990 C2I/91,4				
	80	-	-	-	-	-	-	-	3 580 C2I/78,6	6 670 C2I/82,7	7 610 C2I/83,1	13 250 C2I/81,4	15 220 C2I/80,2	22 010 C2I/78,8	30 010 C2I/80,3	39 420 C2I/82,6	49 270 C2I/82,6	60 020 C2I/81,2				
	80	150 ICI/75,2	240 ICI/79,5	300 ICI/79,5	525 ICI/82,7	620 ICI/82,7	1 200 ICI/76,7	2 280 ICI/78,1	2 620 ICI/78,1	4 610 ICI/78,1	5 270 ICI/80,5	9 480 ICI/78,1	-	-	-	-	-	-	-			
	71	-	-	-	-	-	-	-	3 750 C2I/70,2	6 040 C2I/72,3	7 310 C2I/72	11 860 C2I/70,3	15 880 C2I/72,2	22 670 C2I/71,2	31 320 C2I/71,7	39 700 C2I/71,1	49 400 C2I/71,1	62 640 C2I/73,1				
	63	-	-	-	-	-	-	-	3 690 C2I/62	6 710 C2I/65,2	9 040 C2I/65,5	13 310 C2I/64,2	17 800 C2I/63,2	26 710 C2I/62,1	34 610 C2I/63,3	46 060 C2I/65,1	57 580 C2I/65,1	61 750 C2I/64				
	63	150 ICI/60,1	245 ICI/63,6	300 ICI/63,6	530 ICI/66,2	620 ICI/66,2	1 340 ICI/61,3	2 560 ICI/62,5	3 180 ICI/62,5	5 620 ICI/62,5	7 010 ICI/64,4	11 350 ICI/62,5	-	-	-	-	-	-	-			
	56	-	-	-	-	-	-	-	3 860 C2I/55,4	6 900 C2I/57	8 010 C2I/56,8	14 160 C2I/55,5	16 610 C2I/56,9	27 320 C2I/56,1	32 510 C2I/56,6	43 470 C2I/56	54 340 C2I/56	64 450 C2I/57,6				
	50	-	-	-	-	-	-	-	22 C2I/50,4	37,7 C2I/52,1	48,9 C2I/52,4	72,6 C2I/53,9	97,5 C2I/53,1	150 C2I/52,1	191 C2I/53,1	-	-	-	-	50	2800	56
	50	0,97 160 ICI/49	1,66 290 ICI/50,9	1,95 340 ICI/50,9	3,4 615 ICI/53	3,81 690 ICI/53	7,44 1 270 ICI/49,9	15,1 2 580 ICI/50	19,4 3 270 ICI/49,3	32,2 5 760 ICI/52,5	45,5 7 880 ICI/50,8	63,2 11 320 ICI/52,5	-	-	-	-	-	-	50	2800		
	45	-	-	-	-	-	-	-	3 970 C2I/45,1	7 080 C2I/45,6	8 400 C2I/45,4	14 180 C2I/46,6	16 800 C2I/47,8	27 310 C2I/47,1	33 130 C2I/47,5	41 990 C2I/44,2	52 250 C2I/44,2	66 250 C2I/45,4		45	2500	
40	-	-	-	-	-	-	-	23,4 C2I/38,7	37,6 C2I/39,5	46 C2I/41	75,8 C2I/42,6	96,4 C2I/41,4	140 C2I/42,8	189 C2I/41,6	252 C2I/39,5	314 C2I/39,5	384 C2I/41		40	2240		
40	1,08 175 ICI/38,6	1,74 300 ICI/40,1	2,14 365 ICI/40,1	3,55 635 ICI/41,8	4,11 735 ICI/41,8	9,31 1 560 ICI/39,4	15,8 2 650 ICI/39,4	17,9 3 070 ICI/40,2	38 6 710 ICI/41,4	38,9 6 900 ICI/41,6	71,5 12 610 ICI/41,4	-	-	-	-	-	-	40	2240			

For n_1 lower than 560 min⁻¹ see page 195.

9 - Selection tables (bevel helical gear reducers)

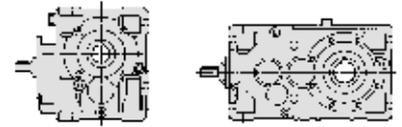

$n_{N2} \cdot L_h$ min ⁻¹ · h	i_N	P_{N2} kW																i_N	n_1	n_{N2} min ⁻¹		
		M_{N2} N m																				
		... / i																				
		50	63	64	80	81	100	125	140	160	180	200	225	250	280	320	321	360				
710 000	35,5	-	-	-	-	-	-	-	22,7 4 070	34,7 6 220	48,4 8 620	72,8 12 270	97,7 16 910	138 24 630	190 34 020	249 43 120	310 53 670	382 68 040	35,5	2000	56	
									C21/37,5	C21/37,5	C21/37,3	C21/35,3	C21/36,2	C21/37,2	C21/37,5	C21/36,3	C21/36,3	C21/37,3				
	31,5	-	-	-	-	-	-	-	23,6 4 000	38,3 6 710	51,3 9 040	73,5 13 330	95,1 16 980	152 26 750	194 34 670	263 43 670	327 54 340	400 68 900	31,5	1800		
									C21/32	C21/33,1	C21/33,2	C21/34,2	C21/33,7	C21/33,1	C21/33,7	C21/31,3	C21/31,3	C21/32,5				
	31,5	1,09 185	1,83 320	2,19 385	3,52 585	3,86 645	8,36 1 450	14,5 2 490	-	31,7 5 270	-	64,8 11 230	-	-	-	-	-	-	31,5	1800		
		ICI/32,1	ICI/33	ICI/33	ICI/31,4	ICI/31,4	ICI/32,8	ICI/32,4		ICI/31,4		ICI/32,7										
	31,5	-	1,37 230	1,53 255	2,69 465	3,34 575	6,53 1 040	12,2 2 030	-	23,9 3 900	-	48,7 7 960	-	95,2 16 030	-	-	-	-	31,5	1800		
			CI/31,3	CI/31,3	CI/32,5	CI/32,5	CI/30,1	CI/31,3		CI/30,8		CI/30,8		CI/31,7								
	28	-	-	-	-	-	-	-	-	24,5 4 180	42,3 7 300	54,6 9 390	80,5 14 180	97,9 17 720	153 27 360	194 34 940	265 44 290	330 55 110	406 69 880	28	1600	
										C21/28,6	C21/28,9	C21/28,8	C21/29,5	C21/30,3	C21/29,9	C21/30,1	C21/28	C21/28	C21/28,8			
	25	-	-	-	-	-	-	-	-	23,8 3 980	43,6 7 460	49,7 8 820	79,5 14 640	98,8 17 700	155 28 670	198 35 500	263 45 000	328 56 000	400 71 000	25	1400	
										C21/24,5	C21/25,1	C21/26	C21/27	C21/26,3	C21/27,2	C21/26,4	C21/25,1	C21/25,1	C21/26			
	25	0,91 150	1,48 250	1,87 320	3,23 570	3,68 650	6,61 1 090	14,4 2 460	-	28,2 4 730	-	56 9 410	-	111 19 250	-	-	-	-	25	1400		
		CI/24,1	CI/25	CI/25	CI/26	CI/26	CI/24,1	CI/25		CI/24,6		CI/24,6		CI/25,4								
22,4	-	-	-	-	-	-	-	-	23,3 4 240	40,3 7 310	49,6 8 970	82,8 14 160	102 17 830	152 27 370	195 35 380	255 44 870	318 55 840	392 70 780	22,4	1250		
									C21/23,8	C21/23,8	C21/23,7	C21/22,4	C21/23	C21/23,6	C21/23,8	C21/23	C21/23	C21/23,7				
20	-	-	-	-	-	-	-	-	21,3 3 710	38,3 6 720	46 8 370	79,3 13 850	91,9 15 600	149 27 190	181 32 140	256 45 000	319 56 000	362 65 920	20	1120		
									C21/20,4	C21/20,6	C21/21,4	C21/20,5	C21/19,9	C21/21,5	C21/20,8	C21/20,6	C21/20,6	C21/21,4				
20	0,91 150	1,58 270	1,94 330	3,23 570	3,73 660	8,18 1 340	14,6 2 500	20,2 3 450	33,1 5 550	40 6 910	63,4 10 650	79,8 13 800	123 21 300	160 27 260	208 34 850	287 48 120	326 56 330	20	1120			
	CI/19,3	CI/20	CI/20	CI/20,8	CI/20,8	CI/19,3	CI/20	CI/20	CI/19,7	CI/20,3	CI/19,7	CI/20,3	CI/20,3	CI/20	CI/19,7	CI/19,7	CI/20,3					
18	-	-	-	-	-	-	-	-	19,9 3 420	32,2 5 530	39,8 7 090	64,2 11 030	78,5 14 000	129 21 940	158 27 120	196 33 710	283 48 700	310 54 500	18	1000		
									CI/18	CI/18	CI/18,7	CI/18	CI/18,7	CI/17,9	CI/18	CI/18	CI/18	CI/18,4				
16	0,93 150	1,61 270	1,98 330	3,29 570	3,8 660	8,33 1 340	15,3 2 560	21,5 3 590	34,1 5 620	43,1 7 320	68,8 11 340	96,3 16 350	136 23 180	175 29 210	204 35 160	263 45 460	342 58 080	16	900			
	CI/15,2	CI/15,8	CI/15,8	CI/16,4	CI/16,4	CI/15,2	CI/15,8	CI/15,8	CI/15,5	CI/16	CI/15,5	CI/16	CI/16	CI/16	CI/15,8	CI/16,3	CI/16,3	CI/16				
14	-	-	-	-	-	-	-	-	21,9 3 710	35,5 6 020	43,8 7 690	69,7 11 810	90,4 15 880	138 23 200	172 29 220	224 37 920	273 46 290	341 59 110	14	800		
									CI/14,2	CI/14,2	CI/14,7	CI/14,2	CI/14,7	CI/14,1	CI/14,2	CI/14,2	CI/14,2	CI/14,5				
12,5	1,07 175	1,79 305	2,25 380	3,77 665	4,36 770	8,04 1 340	17,2 2 910	19,6 3 390	34,6 6 070	39,2 6 920	68,7 12 040	80,5 13 900	137 23 310	155 26 750	209 36 030	256 44 160	325 55 100	12,5	710			
	CI/12,4	CI/12,6	CI/12,6	CI/13,1	CI/13,1	CI/12,4	CI/12,6	CI/12,9	CI/13	CI/13,1	CI/13	CI/12,8	CI/12,6	CI/12,9	CI/12,8	CI/12,8	CI/12,6					
11,2	-	-	-	-	-	-	-	-	22,3 3 800	31,8 5 500	45,8 8 090	61,6 10 510	92,5 16 360	123 21 280	185 31 600	219 36 700	274 45 870	344 59 940	11,2	630		
									CI/11,3	CI/11,4	CI/11,7	CI/11,3	CI/11,7	CI/11,4	CI/11,3	CI/11	CI/11,5					
10	1,05 185	1,84 315	2,26 385	3,75 665	4,34 770	8,27 1 380	17,4 2 970	19,8 3 450	33,8 5 960	42,1 7 460	74,9 13 200	83,1 14 430	133 22 710	166 28 900	234 40 640	286 49 510	331 56 460	10	560			
	CI/10,3	CI/10	CI/10	CI/10,4	CI/10,4	CI/9,81	CI/10	CI/10,2	CI/10,3	CI/10,4	CI/10,3	CI/10,2	CI/10	CI/10,2	CI/10,2	CI/10,2	CI/10					
630 000	200	-	-	-	-	850 ICI/192	2 000 ICI/199	-	3 870 ICI/196	-	7 910 ICI/196	-	-	-	-	-	-	-				
	160	-	-	-	-	-	-	3 350 C21/151	5 000 C21/154	7 100 C21/158	10 300 C21/151	14 500 C21/156	20 600 C21/156	28 690 C21/154	35 500 C21/156	42 500 C21/156	56 600 C21/161					

For n_1 lower than 560 min⁻¹ see page 195.

9 - Selection tables (bevel helical gear reducers)

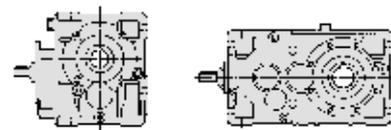

$n_{N2} \cdot L_h$ min ⁻¹ · h	i_N	P_{N2} kW M_{N2} N m ... / i																i_N	n_1 min ⁻¹	n_{N2} min ⁻¹	
		50	63	64	80	81	100	125	140	160	180	200	225	250	280	320	321				360
630 000	160	-	-	-	-	-	1 150 ICI/154	2 300 ICI/159	2 510 ICI/159	4 750 ICI/157	5 480 ICI/162	8 520 ICI/157	-	-	-	-	-	-			
	125	-	-	-	-	-	-	-	3 380 C2I/123	6 150 C2I/129	7 650 C2I/130	12 500 C2I/127	14 820 C2I/125	22 200 C2I/123	25 430 C2I/125	39 010 C2I/129	48 760 C2I/129	50 650 C2I/127			
	125	-	-	-	-	-	1 220 ICI/123	2 430 ICI/127	3 090 ICI/127	5 300 ICI/126	7 040 ICI/130	10 900 ICI/126	-	-	-	-	-	-			
	100	-	-	-	-	-	-	-	3 590 C2I/98,2	6 500 C2I/103	8 130 C2I/104	13 360 C2I/102	15 770 C2I/100	23 610 C2I/98,5	29 640 C2I/100	42 420 C2I/103	53 020 C2I/103	59 270 C2I/102			
	100	-	240 ICI/99,4	285 ICI/99,4	495 ICI/103	580 ICI/103	1 270 ICI/100	2 650 ICI/102	3 160 ICI/100	5 780 ICI/106	7 300 ICI/102	11 360 ICI/106	-	-	-	-	-	-			
	90	-	-	-	-	-	-	-	3 700 C2I/87,8	6 580 C2I/90,4	7 290 C2I/90	12 850 C2I/87,9	15 660 C2I/90,3	22 360 C2I/89	30 880 C2I/89,7	39 140 C2I/88,8	48 710 C2I/88,8	61 760 C2I/91,4			
	80	-	-	-	-	-	-	-	3 630 C2I/78,6	6 740 C2I/82,7	7 720 C2I/83,1	13 360 C2I/81,4	15 440 C2I/80,2	22 800 C2I/78,8	30 440 C2I/80,3	40 840 C2I/82,6	51 050 C2I/82,6	60 870 C2I/81,2			
	80	150 ICI/75,2	240 ICI/79,5	300 ICI/79,5	530 ICI/82,7	625 ICI/82,7	1 210 ICI/76,7	2 370 ICI/78,1	2 660 ICI/78,1	4 680 ICI/78,1	5 350 ICI/80,5	9 620 ICI/78,1	-	-	-	-	-	-			
	71	-	-	-	-	-	-	-	3 800 C2I/70,2	6 260 C2I/72,3	7 420 C2I/72	12 290 C2I/70,3	16 110 C2I/72,2	23 000 C2I/71,2	31 770 C2I/71,7	40 270 C2I/71,1	50 110 C2I/71,1	63 530 C2I/73,1			
	63	-	-	-	-	-	-	-	3 740 C2I/62	6 740 C2I/65,2	9 080 C2I/65,5	13 360 C2I/64,2	18 450 C2I/63,2	26 810 C2I/62,1	34 750 C2I/63,3	46 230 C2I/65,1	57 790 C2I/65,1	62 630 C2I/64			
	63	150 ICI/60,1	245 ICI/63,6	305 ICI/63,6	530 ICI/66,2	625 ICI/66,2	1 350 ICI/61,3	2 570 ICI/62,5	3 220 ICI/62,5	5 650 ICI/62,5	7 040 ICI/64,4	11 390 ICI/62,5	-	-	-	-	-	-			
	56	-	-	-	-	-	-	-	20,7 C2I/55,4	36,5 C2I/57	41,5 C2I/56,8	75,1 C2I/55,5	88,6 C2I/56,9	143 C2I/56,1	175 C2I/56,6	-	-	-	56	2800	50
	50	-	-	-	-	-	-	-	20 C2I/50,4	33,8 C2I/52,1	45,1 C2I/52,4	65 C2I/53,9	90 C2I/53,1	135 C2I/52,1	171 C2I/53,1	-	-	-	50	2500	
	50	0,87 ICI/49	1,49 ICI/50,9	1,75 ICI/50,9	3,05 ICI/53	3,41 ICI/53	6,67 ICI/49,9	13,7 ICI/50	17,6 ICI/49,3	28,8 ICI/52,5	42 ICI/50,8	56,8 ICI/52,5	-	-	-	-	-	50	2500		
	45	-	-	-	-	-	-	-	20,9 C2I/45,1	37,6 C2I/45,6	43,9 C2I/45,4	71,7 C2I/46,6	83,5 C2I/47,8	137 C2I/47,1	167 C2I/47,5	226 C2I/44,2	281 C2I/44,2	347 C2I/45,4	45	2240	
	40	-	-	-	-	-	-	-	21,2 C2I/38,7	34,7 C2I/39,5	41,6 C2I/41	70,1 C2I/42,6	87,2 C2I/41,4	130 C2I/42,8	171 C2I/41,6	228 C2I/39,5	284 C2I/39,5	348 C2I/41	40	2000	
	40	0,96 ICI/38,6	1,57 ICI/40,1	1,93 ICI/40,1	3,22 ICI/41,8	3,72 ICI/41,8	8,34 ICI/39,4	14,3 ICI/39,4	16,2 ICI/40,2	34,1 ICI/41,4	35,9 ICI/41,6	64 ICI/41,4	-	-	-	-	-	40	2000		
	35,5	-	-	-	-	-	-	-	20,7 C2I/37,5	32,3 C2I/37,5	44,1 C2I/37,3	66,3 C2I/35,3	89,1 C2I/36,2	126 C2I/37,2	173 C2I/37,5	227 C2I/36,3	282 C2I/36,3	348 C2I/37,3	35,5	1800	

For n_1 lower than 560 min⁻¹ see page 195.

9 - Selection tables (bevel helical gear reducers)

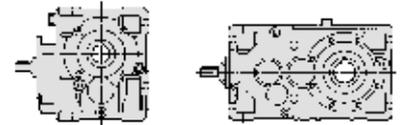

$n_{N2} \cdot L_h$ min ⁻¹ · h	i_N	P_{N2} kW																i_N	n_1	n_{N2} min ⁻¹	
		M_{N2} N m																			
		... / i																			
		50	63	64	80	81	100	125	140	160	180	200	225	250	280	320	321	360			
630 000	31,5	-	-	-	-	-	-	-	21,2 4 050 C21/32	34,1 6 740 C21/33,1	45,8 9 080 C21/33,2	65,6 13 380 C21/34,2	87,2 17 530 C21/33,7	136 26 850 C21/33,1	173 34 800 C21/33,7	237 44 290 C21/31,3	295 55 110 C21/31,3	360 69 880 C21/32,5	31,5	1600	50
	31,5	0,97 185 ICI/32,1	1,67 330 ICI/33	1,95 385 ICI/33	3,17 595 ICI/31,4	3,48 655 ICI/31,4	7,46 1 460 ICI/32,8	13,1 2 530 ICI/32,4	-	28,5 5 340 ICI/31,4	-	57,8 11 280 ICI/32,7	-	-	-	-	-	-	31,5	1600	
	31,5	-	1,23 230 CI/31,3	1,36 255 CI/31,3	2,4 465 CI/32,5	2,98 580 CI/32,5	5,82 1 050 CI/30,1	10,9 2 030 CI/31,3	-	21,3 3 910 CI/30,8	-	43,5 7 980 CI/30,8	-	87,2 16 520 CI/31,7	-	-	-	-	31,5	1600	
	28	-	-	-	-	-	-	-	21,8 4 250 C21/28,6	37,2 7 330 C21/28,9	49,7 9 770 C21/28,8	70,7 14 240 C21/29,5	87,1 18 000 C21/30,3	135 27 480 C21/29,9	173 35 560 C21/30,1	236 45 000 C21/28	293 56 000 C21/28	361 71 000 C21/28,8	28	1400	
	25	-	-	-	-	-	-	-	21,4 4 010 C21/24,5	39,1 7 480 C21/25,1	45 8 940 C21/26	72,1 14 880 C21/27	88,8 17 820 C21/26,3	139 28 770 C21/27,2	176 35 500 C21/26,4	235 45 000 C21/25,1	292 56 000 C21/25,1	357 71 000 C21/26	25	1250	
	25	0,82 150 CI/24,1	1,33 255 CI/25	1,68 320 CI/25	2,89 575 CI/26	3,3 655 CI/26	5,93 1 090 CI/24,1	12,9 2 470 CI/25	-	25,3 4 750 CI/24,6	-	50,5 9 500 CI/24,6	-	100 19 460 CI/25,4	-	-	-	-	25	1250	
	22,4	-	-	-	-	-	-	-	20,9 4 250 C21/23,8	36,2 7 340 C21/23,8	44,6 9 000 C21/23,7	74,5 14 210 C21/22,4	91,9 18 000 C21/23	136 27 470 C21/23,6	175 35 500 C21/23,8	229 45 000 C21/23	286 56 000 C21/23	352 71 000 C21/23,7	22,4	1120	
	20	-	-	-	-	-	-	-	19,2 3 740 C21/20,4	35,4 6 960 C21/20,6	41,4 8 440 C21/21,4	73,3 14 330 C21/20,5	82,9 15 760 C21/19,9	137 28 130 C21/21,5	163 32 470 C21/20,8	229 45 000 C21/20,6	285 56 000 C21/20,6	327 66 600 C21/21,4	20	1000	
	20	0,82 150 CI/19,3	1,41 270 CI/20	1,74 330 CI/20	2,89 575 CI/20,8	3,34 665 CI/20,8	7,33 1 350 CI/19,3	13,5 2 570 CI/20	18,2 3 480 CI/20	30 5 640 CI/19,7	36,1 6 990 CI/20,3	57 10 720 CI/19,7	72 13 940 CI/20,3	111 21 430 CI/20,3	144 27 550 CI/20	186 35 010 CI/19,7	257 48 290 CI/19,7	292 56 530 CI/20,3	20	1000	
	18	-	-	-	-	-	-	-	17,9 3 420 CI/18	29,2 5 580 CI/18	35,8 7 090 CI/18,7	58,3 11 130 CI/18	70,7 14 000 CI/18,7	117 22 140 CI/17,9	142 27 120 CI/18	178 34 000 CI/18	255 48 700 CI/18	279 54 500 CI/18,4	18	900	
	16	0,83 150 CI/15,2	1,43 270 CI/15,8	1,76 330 CI/15,8	2,93 575 CI/16,4	3,39 665 CI/16,4	7,43 1 350 CI/15,2	13,7 2 570 CI/15,8	19,1 3 600 CI/15,8	30,4 5 640 CI/15,5	39,7 7 580 CI/16	61,4 11 380 CI/15,5	86 16 410 CI/16	123 23 450 CI/16	156 29 410 CI/15,8	183 35 500 CI/16,3	235 45 650 CI/16,3	315 60 170 CI/16	16	800	
	14	-	-	-	-	-	-	-	19,6 3 750 CI/14,2	32,7 6 240 CI/14,2	39,2 7 770 CI/14,7	64,1 12 240 CI/14,2	80,5 15 940 CI/14,7	123 23 340 CI/14,1	155 29 530 CI/14,2	201 38 290 CI/14,2	251 47 980 CI/14,2	307 59 810 CI/14,5	14	710	
12,5	0,95 180 CI/12,4	1,6 305 CI/12,6	2,01 385 CI/12,6	3,35 670 CI/13,1	3,88 775 CI/13,1	7,39 1 390 CI/12,4	15,8 3 020 CI/12,6	17,6 3 430 CI/12,9	31,5 6 210 CI/13	35,4 7 030 CI/13,1	61,6 12 170 CI/13	71,7 13 960 CI/12,8	123 23 550 CI/12,6	139 27 030 CI/12,9	187 36 380 CI/12,8	231 44 940 CI/12,8	291 55 730 CI/12,6	12,5	630		
11,2	-	-	-	-	-	-	-	19,9 3 830 CI/11,3	29,3 5 700 CI/11,4	41 8 150 CI/11,7	55,3 10 620 CI/11,3	82,2 16 360 CI/11,7	111 21 500 CI/11,4	166 31 900 CI/11,3	197 37 050 CI/11	245 46 200 CI/11	309 60 510 CI/11,5	11,2	560		
560 000	200	-	-	-	-	875 ICI/192	2 060 ICI/199	-	4 000 ICI/196	-	8 160 ICI/196	-	-	-	-	-	-				
	160	-	-	-	-	-	-	3 450 C21/151	5 150 C21/154	7 300 C21/158	10 600 C21/151	14 500 C21/156	21 200 C21/156	29 740 C21/154	36 500 C21/156	43 700 C21/156	58 660 C21/161				
	160	-	-	-	-	1 210 ICI/154	2 360 ICI/159	2 600 ICI/159	4 770 ICI/157	5 500 ICI/162	8 760 ICI/157	-	-	-	-	-	-				
	125	-	-	-	-	-	-	3 500 C21/123	6 300 C21/129	7 930 C21/130	12 800 C21/127	15 360 C21/125	22 990 C21/123	26 130 C21/125	40 410 C21/129	50 510 C21/129	52 040 C21/127				

For n_1 lower than 560 min⁻¹ see page 195.

9 - Selection tables (bevel helical gear reducers)

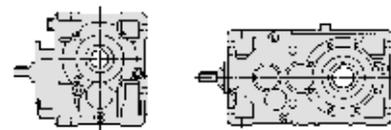

$n_{N2} \cdot L_h$ min ⁻¹ · h	i_N	P_{N2} kW																i_N	n_1	n_{N2} min ⁻¹			
		M_{N2} N m																					
		... / i																					
		50	63	64	80	81	100	125	140	160	180	200	225	250	280	320	321	360					
560 000	125	-	-	-	-	-	1 250 ICI/123	2 500 ICI/127	3 200 ICI/127	5 450 ICI/126	7 060 ICI/130	11 440 ICI/126	-	-	-	-	-	-					
	100	-	-	-	-	-	-	-	3 700 C2I/98,2	6 500 C2I/103	8 390 C2I/104	13 410 C2I/102	16 270 C2I/100	24 370 C2I/98,5	30 010 C2I/100	43 780 C2I/103	54 730 C2I/103	60 020 C2I/102					
	100	-	240 ICI/99,4	285 ICI/99,4	495 ICI/103	580 ICI/103	1 280 ICI/100	2 730 ICI/102	3 270 ICI/100	5 800 ICI/106	7 300 ICI/102	11 400 ICI/106	-	-	-	-	-	-	-				
	90	-	-	-	-	-	-	-	3 750 C2I/87,8	6 810 C2I/90,4	7 540 C2I/90	13 310 C2I/87,9	15 880 C2I/90,3	22 810 C2I/89	31 320 C2I/89,7	39 700 C2I/88,8	49 400 C2I/88,8	62 640 C2I/91,4					
	80	-	-	-	-	-	-	-	3 690 C2I/78,6	6 760 C2I/82,7	7 990 C2I/83,1	13 410 C2I/81,4	15 660 C2I/80,2	23 630 C2I/78,8	30 870 C2I/80,3	42 320 C2I/82,6	52 910 C2I/82,6	61 750 C2I/81,2					
	80	150 ICI/75,2	245 ICI/79,5	300 ICI/79,5	530 ICI/82,7	625 ICI/82,7	1 210 ICI/76,7	2 450 ICI/78,1	2 700 ICI/78,1	4 740 ICI/78,1	5 430 ICI/80,5	9 750 ICI/78,1	-	-	-	-	-	-	-				
	71	-	-	-	-	-	-	-	3 860 C2I/70,2	6 490 C2I/72,3	7 520 C2I/72	12 740 C2I/70,3	16 340 C2I/72,2	23 330 C2I/71,2	32 220 C2I/71,7	40 850 C2I/71,1	50 830 C2I/71,1	64 450 C2I/73,1					
	63	-	-	-	-	-	-	-	17,9 C2I/62	30,4 C2I/65,2	40,8 C2I/65,5	61,3 13 410	88,6 19 110	127 26 910	162 34 870	-	46 410 C2I/65,1	58 010 C2I/65,1	64 840 C2I/64	63	2800	45	
	63	0,74 150 ICI/60,1	1,15 250 ICI/63,6	1,42 310 ICI/63,6	2,37 535 ICI/66,2	2,77 625 ICI/66,2	6,48 1 350 ICI/61,3	12,1 2 580 ICI/62,5	15,3 3 270 ICI/62,5	26,6 5 670 ICI/62,5	32,2 7 060 ICI/64,4	53,6 11 430 ICI/62,5	-	-	-	-	-	-	63	2800			
	56	-	-	-	-	-	-	-	18,8 3 970 C2I/55,4	32,6 7 100 C2I/57	37,2 8 070 C2I/56,8	67,3 14 260 C2I/55,5	81,9 17 810 C2I/56,9	128 27 520 C2I/56,1	161 34 840 C2I/56,6	-	43 790 C2I/56	54 730 C2I/56	66 250 C2I/57,6	56	2500		
	50	-	-	-	-	-	-	-	18,1 3 900 C2I/50,4	30,4 6 760 C2I/52,1	40,8 9 110 C2I/52,4	58,5 13 430 C2I/53,9	83,4 18 860 C2I/53,1	121 26 950 C2I/52,1	154 34 930 C2I/53,1	212 46 380 C2I/51,3	265 57 980 C2I/51,3	303 65 230 C2I/50,5	50	2240			
	50	0,78 165 ICI/49	1,34 290 ICI/50,9	1,57 340 ICI/50,9	2,74 620 ICI/53	3,07 695 ICI/53	6 1 280 ICI/49,9	12,4 2 650 ICI/50	16 3 360 ICI/49,3	26 5 810 ICI/52,5	38 8 220 ICI/50,8	51,6 11 540 ICI/52,5	-	-	-	-	-	-	50	2240			
	45	-	-	-	-	-	-	-	18,9 4 070 C2I/45,1	33,8 7 360 C2I/45,6	39,8 8 620 C2I/45,4	64,2 14 280 C2I/46,6	77 17 580 C2I/47,8	122 27 560 C2I/47,1	154 34 970 C2I/47,5	208 43 770 C2I/44,2	259 54 710 C2I/44,2	314 68 040 C2I/45,4	45	2000			
	40	-	-	-	-	-	-	-	19,3 3 960 C2I/38,7	32,3 6 770 C2I/39,5	37,9 8 250 C2I/41	65,1 14 700 C2I/42,6	79,5 17 470 C2I/41,4	121 27 390 C2I/42,8	156 34 450 C2I/41,6	208 43 670 C2I/39,5	259 54 340 C2I/39,5	317 68 900 C2I/41	40	1800			
	40	0,87 180 ICI/38,6	1,44 305 ICI/40,1	1,76 375 ICI/40,1	2,93 650 ICI/41,8	3,39 750 ICI/41,8	7,53 1 570 ICI/39,4	13 2 720 ICI/39,4	14,8 3 150 ICI/40,2	30,8 6 760 ICI/41,4	33,4 7 370 ICI/41,6	57,8 12 690 ICI/41,4	-	-	-	-	-	-	40	1800			
	35,5	-	-	-	-	-	-	-	18,7 4 180 C2I/37,5	29,7 6 650 C2I/37,5	39,8 8 860 C2I/37,3	59,9 12 630 C2I/35,3	80,3 17 370 C2I/36,2	114 25 290 C2I/37,2	156 34 940 C2I/37,5	205 44 290 C2I/36,3	255 55 110 C2I/36,3	314 69 880 C2I/37,3	35,5	1600			
31,5	-	-	-	-	-	-	-	18,9 4 120 C2I/32	30 6 760 C2I/33,1	40,2 9 120 C2I/33,2	57,7 13 440 C2I/34,2	79,5 18 240 C2I/33,7	120 26 960 C2I/33,1	152 34 940 C2I/33,7	211 45 000 C2I/31,3	262 56 000 C2I/31,3	320 71 000 C2I/32,5	31,5	1400				
31,5	0,85 185 ICI/32,1	1,46 330 ICI/33	1,72 385 ICI/33	2,82 605 ICI/31,4	3,09 665 ICI/31,4	6,55 1 470 ICI/32,8	11,6 2 570 ICI/32,4	-	25,4 5 430 ICI/31,4	-	50,8 11 320 ICI/32,7	-	-	-	-	-	-	31,5	1400				

For n_1 lower than 560 min⁻¹ see page 195.

9 - Selection tables (bevel helical gear reducers)

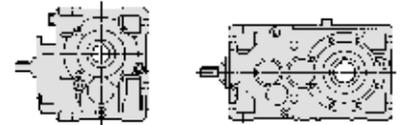

$n_{N2} \cdot L_h$ min ⁻¹ · h	i_N	P_{N2} kW																i_N	n_1	n_{N2}	
		M_{N2} N m																			
		... / i																			
		50	63	64	80	81	100	125	140	160	180	200	225	250	280	320	321	360			
560 000	31,5	-	1,08 230 CI/31,3	1,2 255 CI/31,3	2,1 465 CI/32,5	2,62 580 CI/32,5	5,12 1 050 CI/30,1	9,58 2 040 CI/31,3	-	18,7 3 930 CI/30,8	-	38,2 8 020 CI/30,8	-	76,6 16 590 CI/31,7	-	-	-	-	31,5	1400	45
	28	-	-	-	-	-	-	-	19,5 4 250 C2I/28,6	33,3 7 360 C2I/28,9	45 9 900 C2I/28,8	63,3 14 290 C2I/29,5	77,7 18 000 C2I/30,3	121 27 580 C2I/29,9	160 36 790 C2I/30,1	210 45 000 C2I/28	262 56 000 C2I/28	323 71 000 C2I/28,8	28	1250	
	25	-	-	-	-	-	-	-	19,3 4 030 C2I/24,5	35,1 7 510 C2I/25,1	40,5 8 970 C2I/26	64,8 14 930 C2I/27	80,1 17 940 C2I/26,3	125 28 870 C2I/27,2	158 35 500 C2I/26,4	211 45 000 C2I/25,1	262 56 000 C2I/25,1	320 71 000 C2I/26	25	1120	
	25	0,74 150 CI/24,1	1,2 255 CI/25	1,51 320 CI/25	2,6 575 CI/26	2,97 660 CI/26	5,34 1 100 CI/24,1	11,6 2 480 CI/25	-	22,8 4 790 CI/24,6	-	45,7 9 590 CI/24,6	-	90,8 19 660 CI/25,4	-	-	-	-	25	1120	
	22,4	-	-	-	-	-	-	-	18,7 4 250 C2I/23,8	32,5 7 370 C2I/23,8	39,8 9 000 C2I/23,7	66,7 14 260 C2I/22,4	82 18 000 C2I/23	122 27 570 C2I/23,6	156 35 500 C2I/23,8	205 45 000 C2I/23	255 56 000 C2I/23	314 71 000 C2I/23,7	22,4	1000	
	20	-	-	-	-	-	-	-	17,3 3 750 C2I/20,4	32,9 7 180 C2I/20,6	37,5 8 490 C2I/21,4	68,1 14 790 C2I/20,5	75,3 15 900 C2I/19,9	127 28 860 C2I/21,5	148 32 770 C2I/20,8	206 45 000 C2I/20,6	256 56 000 C2I/20,6	297 67 220 C2I/21,4	20	900	
	20	0,74 150 CI/19,3	1,27 270 CI/20	1,57 335 CI/20	2,61 575 CI/20,8	3,02 665 CI/20,8	6,62 1 350 CI/19,3	12,2 2 580 CI/20	16,5 3 510 CI/20	27,1 5 660 CI/19,7	32,8 7 060 CI/20,3	51,6 10 770 CI/19,7	65,4 14 080 CI/20,3	100 21 550 CI/20,3	131 27 810 CI/20	168 35 160 CI/19,7	232 48 450 CI/19,7	264 56 720 CI/20,3	20	900	
	18	-	-	-	-	-	-	-	15,9 3 420 CI/18	26,2 5 630 CI/18	31,8 7 090 CI/18,7	52,3 11 240 CI/18	62,8 14 000 CI/18,7	105 22 350 CI/17,9	126 27 120 CI/18	160 34 320 CI/18	227 48 700 CI/18	248 54 500 CI/18,4	18	800	
	16	0,74 150 CI/15,2	1,27 270 CI/15,8	1,57 335 CI/15,8	2,61 575 CI/16,4	3,02 665 CI/16,4	6,62 1 350 CI/15,2	12,1 2 570 CI/15,8	17,1 3 620 CI/15,8	27,1 5 660 CI/15,5	36,5 7 860 CI/16	54,7 11 430 CI/15,5	76,6 16 470 CI/16	109 23 530 CI/16	140 29 620 CI/15,8	164 35 850 CI/16,3	209 45 830 CI/16,3	290 62 360 CI/16	16	710	
	14	-	-	-	-	-	-	-	17,6 3 780 CI/14,2	30 6 460 CI/14,2	35,4 7 900 CI/14,7	57,3 12 330 CI/14,2	71,7 16 000 CI/14,7	110 23 480 CI/14,1	139 29 840 CI/14,2	180 38 670 CI/14,2	231 49 730 CI/14,2	282 62 000 CI/14,5	14	630	
12,5	0,85 180 CI/12,4	1,43 305 CI/12,6	1,79 385 CI/12,6	2,99 670 CI/13,1	3,46 775 CI/13,1	6,81 1 440 CI/12,4	14,3 3 070 CI/12,6	16,2 3 540 CI/12,9	29 6 440 CI/13	32,6 7 280 CI/13,1	55,3 12 290 CI/13	63,9 14 000 CI/12,8	111 23 780 CI/12,6	124 27 200 CI/12,9	168 36 720 CI/12,8	206 45 000 CI/12,8	259 55 730 CI/12,6	12,5	560		
500 000	200	-	-	-	-	900 ICI/192	2 120 ICI/199	-	4 120 ICI/196	-	8 460 ICI/196	-	-	-	-	-	-	-	-	-	-
	160	-	-	-	-	-	-	3 630 C2I/151	5 300 C2I/154	7 500 C2I/158	10 900 C2I/151	15 000 C2I/156	21 800 C2I/156	30 830 C2I/154	37 500 C2I/156	45 000 C2I/156	60 800 C2I/161	-	-	-	-
	160	-	-	-	-	1 220 ICI/154	2 490 ICI/159	2 700 ICI/159	4 780 ICI/157	5 520 ICI/162	8 990 ICI/157	-	-	-	-	-	-	-	-	-	-
	125	-	-	-	-	-	-	3 620 C2I/123	6 500 C2I/129	8 200 C2I/130	13 200 C2I/127	15 890 C2I/125	23 790 C2I/123	26 940 C2I/125	41 810 C2I/129	52 260 C2I/129	52 750 C2I/127	-	-	-	-
	125	-	-	-	-	1 280 ICI/123	2 590 ICI/127	3 310 ICI/127	5 690 ICI/126	7 090 ICI/130	11 480 ICI/126	-	-	-	-	-	-	-	-	-	-
	100	-	-	-	-	-	-	3 840 C2I/98,2	6 700 C2I/103	8 700 C2I/104	13 460 C2I/102	16 860 C2I/100	25 240 C2I/98,5	30 440 C2I/100	45 360 C2I/103	56 690 C2I/103	60 870 C2I/102	-	-	-	-
	100	-	240 ICI/99,4	285 ICI/99,4	495 ICI/103	585 ICI/103	1 280 ICI/100	2 830 ICI/102	3 380 ICI/100	5 820 ICI/106	7 500 ICI/102	11 440 ICI/106	-	-	-	-	-	-	-	-	-

For n_1 lower than 560 min⁻¹ see page 195.

9 - Selection tables (bevel helical gear reducers)

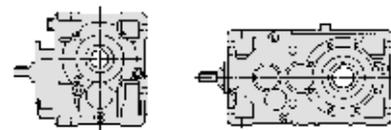

$n_{N2} \cdot L_h$ min ⁻¹ · h	i_N	P_{N2} kW																i_N	n_1	n_{N2}		
		M_{N2} N m																				
		... / i																				
		50	63	64	80	81	100	125	140	160	180	200	225	250	280	320	321	360				
500 000	90	-	-	-	-	-	-	-	3 800 C21/87,8	6 900 C21/90,4	7 810 C21/90	13 790 C21/87,9	16 110 C21/90,3	23 650 C21/89	31 770 C21/89,7	40 460 C21/88,8	50 570 C21/88,8	63 530 C21/91,4				
	80	-	-	-	-	-	-	-	3 740 C21/78,6	6 790 C21/82,7	8 290 C21/83,1	13 460 C21/81,4	16 140 C21/80,2	24 490 C21/78,8	31 320 C21/80,3	43 870 C21/82,6	54 840 C21/82,6	62 630 C21/81,2				
	80	150 ICI/75,2	245 ICI/79,5	305 ICI/79,5	535 ICI/82,7	625 ICI/82,7	1 220 ICI/76,7	2 490 ICI/78,1	2 740 ICI/78,1	4 810 ICI/78,1	5 500 ICI/80,5	9 890 ICI/78,1	-	-	-	-	-	-	-			
	71	-	-	-	-	-	-	-	16,3 3 910 C21/70,2	27,3 6 720 C21/72,3	31,1 7 630 C21/72	55 13 200 C21/70,3	67,3 16 570 C21/72,2	97,4 23 660 C21/71,2	134 32 680 C21/71,7	-	-	-	71	2800	40	
	63	-	-	-	-	-	-	-	16,2 3 840 C21/62	27,3 6 790 C21/65,2	36,5 9 140 C21/65,5	54,9 13 460 C21/64,2	79,6 19 210 C21/63,2	114 27 000 C21/62,1	145 35 000 C21/63,3	-	-	-	63	2500		
	63	0,66 150 ICI/60,1	1,04 255 ICI/63,6	1,29 315 ICI/63,6	2,14 540 ICI/66,2	2,48 625 ICI/66,2	5,8 1 360 ICI/61,3	10,8 2 590 ICI/62,5	13,9 3 310 ICI/62,5	23,8 5 690 ICI/62,5	28,8 7 090 ICI/64,4	48,1 11 480 ICI/62,5	-	-	-	-	-	-	63	2500		
	56	-	-	-	-	-	-	-	17 4 020 C21/55,4	30,4 7 380 C21/57	33,4 8 100 C21/56,8	60,5 14 310 C21/55,5	75,8 18 400 C21/56,9	115 27 620 C21/56,1	149 36 010 C21/56,6	184 43 940 C21/56	230 54 920 C21/56	273 67 130 C21/57,6	56	2240		
	50	-	-	-	-	-	-	-	16,4 3 950 C21/50,4	27,3 6 790 C21/52,1	36,5 9 140 C21/52,4	52,4 13 480 C21/53,9	75,9 19 240 C21/53,1	109 27 040 C21/52,1	138 35 050 C21/53,1	190 46 550 C21/51,3	238 58 190 C21/51,3	274 66 120 C21/50,5	50	2000		
	50	0,7 165 ICI/49	1,2 290 ICI/50,9	1,41 340 ICI/50,9	2,46 620 ICI/53	2,75 695 ICI/53	5,37 1 280 ICI/49,9	11,2 2 680 ICI/50	14,5 3 400 ICI/49,3	23,5 5 890 ICI/52,5	34 8 250 ICI/50,8	46,7 11 700 ICI/52,5	-	-	-	-	-	-	50	2000		
	45	-	-	-	-	-	-	-	17,2 4 120 C21/45,1	30,5 7 380 C21/45,6	36,2 8 730 C21/45,4	58 14 330 C21/46,6	71,5 18 140 C21/47,8	111 27 660 C21/47,1	143 36 090 C21/47,5	187 43 910 C21/44,2	234 54 890 C21/44,2	286 68 900 C21/45,4	45	1800		
	40	-	-	-	-	-	-	-	17,4 4 020 C21/38,7	29,7 7 010 C21/39,5	34,2 8 360 C21/41	58,9 14 980 C21/42,6	71,7 17 720 C21/41,4	111 28 370 C21/42,8	141 34 940 C21/41,6	188 44 290 C21/39,5	234 55 110 C21/39,5	286 69 880 C21/41	40	1600		
	40	0,78 180 ICI/38,6	1,29 310 ICI/40,1	1,59 380 ICI/40,1	2,64 660 ICI/41,8	3,06 765 ICI/41,8	6,72 1 580 ICI/39,4	11,7 2 760 ICI/39,4	13,3 3 200 ICI/40,2	27,5 6 780 ICI/41,4	30,8 7 630 ICI/41,6	51,6 12 740 ICI/41,4	-	-	-	-	-	-	40	1600		
	35,5	-	-	-	-	-	-	-	16,6 4 250 C21/37,5	27,1 6 920 C21/37,5	35,4 9 000 C21/37,3	54,6 13 140 C21/35,3	71,4 17 650 C21/36,2	101 25 700 C21/37,2	139 35 500 C21/37,5	182 45 000 C21/36,3	226 56 000 C21/36,3	279 71 000 C21/37,3	35,5	1400		
	31,5	-	-	-	-	-	-	-	16,9 4 120 C21/32	26,9 6 790 C21/33,1	36 9 150 C21/33,2	51,7 13 490 C21/34,2	73,4 18 870 C21/33,7	107 27 060 C21/33,1	136 35 070 C21/33,7	188 45 000 C21/31,3	234 56 000 C21/31,3	286 71 000 C21/32,5	31,5	1250		
	31,5	0,77 190 ICI/32,1	1,31 330 ICI/33	1,54 385 ICI/33	2,54 610 ICI/31,4	2,78 665 ICI/31,4	5,87 1 470 ICI/32,8	10,4 2 570 ICI/32,4	-	22,9 5 480 ICI/31,4	-	45,5 11 360 ICI/32,7	-	-	-	-	-	-	31,5	1250		
	31,5	-	0,97 230 CI/31,3	1,07 255 CI/31,3	1,89 470 CI/32,5	2,35 585 CI/32,5	4,58 1 050 CI/30,1	8,58 2 050 CI/31,3	-	16,8 3 940 CI/30,8	-	34,2 8 050 CI/30,8	-	68,7 16 650 CI/31,7	-	-	-	-	31,5	1250		
	28	-	-	-	-	-	-	-	17,4 4 250 C21/28,6	29,9 7 390 C21/28,9	40,5 9 930 C21/28,8	57 14 340 C21/29,5	69,6 18 000 C21/30,3	109 27 670 C21/29,9	148 38 020 C21/30,1	188 45 000 C21/28	235 56 000 C21/28	289 71 000 C21/28,8	28	1120		
	25	-	-	-	-	-	-	-	17,3 4 060 C21/24,5	31,5 7 540 C21/25,1	36,3 9 000 C21/26	58,1 14 990 C21/27	71,8 18 000 C21/26,3	112 28 980 C21/27,2	141 35 500 C21/26,4	188 45 000 C21/25,1	234 56 000 C21/25,1	286 71 000 C21/26	25	1000		

For n_1 lower than 560 min⁻¹ see page 195.

9 - Selection tables (bevel helical gear reducers)

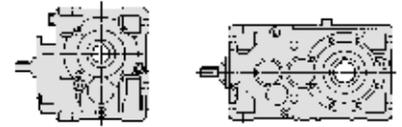

$n_{N2} \cdot L_h$ min ⁻¹ · h	i_N	P_{N2} kW																i_N	n_1 min ⁻¹	n_{N2} min ⁻¹		
		M_{N2} N m																				
		... / i																				
		50	63	64	80	81	100	125	140	160	180	200	225	250	280	320	321	360				
500 000	25	0,66 150 CI/24,1	1,07 255 CI/25	1,35 325 CI/25	2,33 580 CI/26	2,67 660 CI/26	4,79 1 100 CI/24,1	10,4 2 490 CI/25	-	20,6 4 840 CI/24,6	-	41,4 9 730 CI/24,6	-	81,9 19 860 CI/25,4	-	-	-	-	-	25	1000	40
	22,4	-	-	-	-	-	-	-	16,8 4 250 C2I/23,8	29,3 7 390 C2I/23,8	36,5 9 160 C2I/23,7	60,3 14 310 C2I/22,4	73,8 18 000 C2I/23	110 27 660 C2I/23,6	142 35 770 C2I/23,8	184 45 000 C2I/23	229 56 000 C2I/23	283 71 000 C2I/23,7	22,4	900		
	20	-	-	-	-	-	-	-	15,5 3 770 C2I/20,4	30,3 7 440 C2I/20,6	33,6 8 570 C2I/21,4	61,2 14 960 C2I/20,5	67,6 16 070 C2I/19,9	113 28 960 C2I/21,5	133 33 120 C2I/20,8	183 45 000 C2I/20,6	228 56 000 C2I/20,6	266 67 930 C2I/21,4	20	800		
	20	0,66 150 CI/19,3	1,14 270 CI/20	1,4 335 CI/20	2,33 580 CI/20,8	2,69 670 CI/20,8	5,9 1 360 CI/19,3	10,8 2 590 CI/20	14,8 3 530 CI/20	24,2 5 680 CI/19,7	29,5 7 140 CI/20,3	46,1 10 840 CI/19,7	58,8 14 230 CI/20,3	89,4 21 680 CI/20,3	118 28 100 CI/20	150 35 340 CI/19,7	207 48 630 CI/19,7	235 56 930 CI/20,3	20	800		
	18	-	-	-	-	-	-	-	14,1 3 420 CI/18	23,5 5 690 CI/18	28,2 7 090 CI/18,7	46,9 11 350 CI/18	55,8 14 000 CI/18,7	93,9 22 570 CI/17,9	112 27 120 CI/18	143 34 640 CI/18	201 48 700 CI/18	220 54 500 CI/18,4	18	710		
	16	0,66 150 CI/15,2	1,13 270 CI/15,8	1,4 335 CI/15,8	2,33 580 CI/16,4	2,69 670 CI/16,4	5,9 1 360 CI/15,2	10,8 2 570 CI/15,8	15,2 3 630 CI/15,8	24,1 5 680 CI/15,5	33,6 8 150 CI/16	48,7 11 470 CI/15,5	68,1 16 500 CI/16	97,2 23 600 CI/16	126 30 020 CI/15,8	147 36 190 CI/16,3	187 46 000 CI/16,3	267 64 640 CI/16	16	630		
	14	-	-	-	-	-	-	-	16,2 3 910 CI/14,2	26,8 6 480 CI/14,2	32,6 8 180 CI/14,7	51,1 12 370 CI/14,2	63,7 16 000 CI/14,7	98,2 23 600 CI/14,1	125 30 140 CI/14,2	161 39 050 CI/14,2	207 50 000 CI/14,2	259 64 090 CI/14,5	14	560		
	450 000	200	-	-	-	-	-	925 ICI/192	2 180 ICI/199	-	4 250 ICI/196	-	8 500 ICI/196	-	-	-	-	-	-			
160		-	-	-	-	-	-	-	3 640 C2I/151	5 450 C2I/154	7 750 C2I/158	11 500 C2I/151	15 500 C2I/156	22 400 C2I/156	30 700 C2I/154	38 700 C2I/156	46 200 C2I/156	62 990 C2I/161				
160		-	-	-	-	-	1 220 ICI/154	2 500 ICI/159	2 790 ICI/159	4 800 ICI/157	5 540 ICI/162	9 240 ICI/157	-	-	-	-	-	-				
125		-	-	-	-	-	-	-	3 740 C2I/123	6 500 C2I/129	8 460 C2I/130	13 500 C2I/127	16 400 C2I/125	24 550 C2I/123	27 810 C2I/125	43 150 C2I/129	53 930 C2I/129	53 420 C2I/127				
125		-	-	-	-	-	1 280 ICI/123	2 600 ICI/127	3 420 ICI/127	5 710 ICI/126	7 110 ICI/130	11 520 ICI/126	-	-	-	-	-	-				
100		-	-	-	-	-	-	-	3 980 C2I/98,2	6 810 C2I/103	9 010 C2I/104	13 510 C2I/102	17 470 C2I/100	26 160 C2I/98,5	30 870 C2I/100	46 730 C2I/103	58 420 C2I/103	61 750 C2I/102				
100		-	240 ICI/99,4	290 ICI/99,4	500 ICI/103	585 ICI/103	1 290 ICI/100	2 890 ICI/102	3 510 ICI/100	5 840 ICI/106	7 500 ICI/102	11 480 ICI/106	-	-	-	-	-	-				
90		-	-	-	-	-	-	-	3 860 C2I/87,8	6 900 C2I/90,4	8 100 C2I/90	14 300 C2I/87,9	16 340 C2I/90,3	24 510 C2I/89	32 220 C2I/89,7	41 940 C2I/88,8	52 420 C2I/88,8	64 450 C2I/91,4				
80		-	-	-	-	-	-	-	14,2 3 790 C2I/78,6	24,2 6 810 C2I/82,7	30,3 8 580 C2I/83	48,7 13 510 C2I/81,4	61,1 16 720 C2I/80,2	94,4 25 370 C2I/78,8	116 31 760 C2I/80,3	-	-	-	80	2800	35,5	
80		0,59 150 ICI/75,2	0,92 250 ICI/79,5	1,14 310 ICI/79,5	1,9 535 ICI/82,7	2,23 630 ICI/82,7	4,67 1 220 ICI/76,7	9,37 2 500 ICI/78,1	10,4 2 770 ICI/78,1	18,3 4 880 ICI/78,1	20,3 5 580 ICI/80,5	37,7 10 030 ICI/78,1	-	-	-	-	-	-	80	2800		
71	-	-	-	-	-	-	-	14,8 3 970 C2I/70,2	25,2 6 960 C2I/72,3	28,1 7 730 C2I/72	50,8 13 650 C2I/70,3	60,9 16 800 C2I/72,2	88,2 23 980 C2I/71,2	121 33 130 C2I/71,7	-	-	-	71	2500			

For n_1 lower than 560 min⁻¹ see page 195.

9 - Selection tables (bevel helical gear reducers)

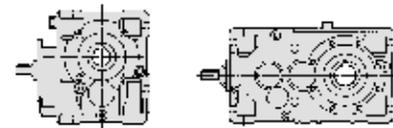

$n_{N2} \cdot L_h$ min ⁻¹ · h	i_N	P_{N2} kW																i_N	n_1	n_{N2} min ⁻¹	
		M_{N2} N m																			
		... / i																			
		50	63	64	80	81	100	125	140	160	180	200	225	250	280	320	321	360			
450 000	63	-	-	-	-	-	-	-	14,9 3 920	24,5 6 810	32,9 9 180	49,4 13 510	71,5 19 280	102 27 100	130 35 120	168 46 730	210 58 420	254 69 330	63	2240	35,5
									C21/62	C21/65,2	C21/65,5	C21/64,2	C21/63,2	C21/62,1	C21/63,3	C21/65,1	C21/65,1	C21/64			
	63	0,59 150	0,95 255	1,17 315	1,94 550	2,24 635	5,22 1 360	9,75 2 600	12,6 3 360	21,4 5 710	25,9 7 110	43,2 11 520	-	-	-	-	-	-	63	2240	
		ICI/60,1	ICI/63,6	ICI/63,6	ICI/66,2	ICI/66,2	ICI/61,3	ICI/62,5	ICI/62,5	ICI/62,5	ICI/64,4	ICI/62,5									
	56	-	-	-	-	-	-	-	15,4 4 070	27,2 7 410	30 8 120	54,2 14 360	70 19 040	103 27 720	138 37 250	165 44 090	206 55 120	247 68 040	56	2000	
									C21/55,4	C21/57	C21/56,8	C21/55,5	C21/56,9	C21/56,1	C21/56,6	C21/56	C21/56	C21/57,6			
	50	-	-	-	-	-	-	-	14,9 4 000	24,6 6 810	33 9 170	47,3 13 520	68,6 19 310	98,1 27 130	125 35 170	172 46 700	214 58 380	251 67 100	50	1800	
									C21/50,4	C21/52,1	C21/52,4	C21/53,9	C21/53,1	C21/52,1	C21/53,1	C21/51,3	C21/51,3	C21/50,5			
	50	0,63 165	1,08 295	1,27 345	2,22 625	2,48 700	4,85 1 290	10,3 2 740	13,2 3 450	21,4 5 970	30,7 8 280	42,6 11 850	-	-	-	-	-	-	50	1800	
		ICI/49	ICI/50,9	ICI/50,9	ICI/53	ICI/53	ICI/49,9	ICI/50	ICI/49,3	ICI/52,5	ICI/50,8	ICI/52,5									
	45	-	-	-	-	-	-	-	15,5 4 180	27,2 7 410	33 8 950	51,8 14 380	65,9 18 790	98,7 27 760	132 37 390	168 44 290	209 55 110	258 69 880	45	1600	
									C21/45,1	C21/45,6	C21/45,4	C21/46,6	C21/47,8	C21/47,1	C21/47,5	C21/44,2	C21/44,2	C21/45,4			
	40	-	-	-	-	-	-	-	15,5 4 090	27,1 7 300	30,4 8 500	51,8 15 040	63,7 18 000	99,5 29 080	125 35 500	167 45 000	208 56 000	254 71 000	40	1400	
									C21/38,7	C21/39,5	C21/41	C21/42,6	C21/41,4	C21/42,8	C21/41,6	C21/39,5	C21/39,5	C21/41			
	40	0,68 180	1,15 315	1,41 385	2,35 670	2,72 775	5,9 1 590	10,4 2 800	11,9 3 250	24,1 6 810	28 7 940	45,3 12 790	-	-	-	-	-	-	40	1400	
		ICI/38,6	ICI/40,1	ICI/40,1	ICI/41,8	ICI/41,8	ICI/39,4	ICI/39,4	ICI/40,2	ICI/41,4	ICI/41,6	ICI/41,4									
35,5	-	-	-	-	-	-	-	14,8 4 250	25 7 160	31,6 9 000	50,4 13 600	64,4 17 830	93,4 26 570	126 36 080	162 45 000	202 56 000	249 71 000	35,5	1250		
								C21/37,5	C21/37,5	C21/37,3	C21/35,3	C21/36,2	C21/37,2	C21/37,5	C21/36,3	C21/36,3	C21/37,3				
31,5	-	-	-	-	-	-	-	15,1 4 120	24,2 6 810	32,4 9 180	46,4 13 530	67,3 19 320	96,3 27 150	122 35 190	168 45 000	210 56 080	256 71 000	31,5	1120		
								C21/32	C21/33,1	C21/33,2	C21/34,2	C21/33,7	C21/33,1	C21/33,7	C21/31,3	C21/31,3	C21/32,5				
31,5	0,69 190	1,18 330	1,38 385	2,29 615	2,52 675	5,28 1 480	9,31 2 570	-	20,7 5 530	-	40,9 11 400	-	-	-	-	-	-	31,5	1120		
	ICI/32,1	ICI/33	ICI/33	ICI/31,4	ICI/31,4	ICI/32,8	ICI/32,4		ICI/31,4		ICI/32,7										
31,5	-	0,87 230	0,96 255	1,7 470	2,11 585	4,12 1 060	7,72 2 060	-	15,1 3 950	-	30,8 8 070	-	61,7 16 710	-	-	-	-	31,5	1120		
		CI/31,3	CI/31,3	CI/32,5	CI/32,5	CI/30,1	CI/31,3		CI/30,8		CI/30,8		CI/31,7								
28	-	-	-	-	-	-	-	15,6 4 250	26,8 7 410	36,3 9 970	51 14 390	62,8 18 170	97,3 27 770	137 39 330	168 45 000	209 56 000	258 71 000	28	1000		
								C21/28,6	C21/28,9	C21/28,8	C21/29,5	C21/30,3	C21/29,9	C21/30,1	C21/28	C21/28	C21/28,8				
25	-	-	-	-	-	-	-	15,7 4 080	28,4 7 560	32,7 9 030	52,5 15 040	64,6 18 000	101 29 070	127 35 520	169 45 000	211 56 000	257 71 000	25	900		
								C21/24,5	C21/25,1	C21/26	C21/27	C21/26,3	C21/27,2	C21/26,4	C21/25,1	C21/25,1	C21/26				
25	0,6 150	0,97 255	1,22 325	2,1 580	2,41 665	4,33 1 110	9,41 2 500	-	18,7 4 880	-	37,4 9 770	-	74,5 20 060	-	-	-	-	25	900		
	CI/24,1	CI/25	CI/25	CI/26	CI/26	CI/24,1	CI/25		CI/24,6		CI/24,6		CI/25,4								
22,4	-	-	-	-	-	-	-	15 4 250	26,2 7 420	33,6 9 490	53,8 14 360	65,6 18 000	98,4 27 760	130 37 060	164 45 000	204 56 000	251 71 000	22,4	800		
								C21/23,8	C21/23,8	C21/23,7	C21/22,4	C21/23	C21/23,6	C21/23,8	C21/23	C21/23	C21/23,7				
20	-	-	-	-	-	-	-	13,8 3 800	27,3 7 570	30,9 8 880	54,5 15 000	60,6 16 230	100 29 000	120 33 610	162 45 000	202 56 000	239 68 640	20	710		
								C21/20,4	C21/20,6	C21/21,4	C21/20,5	C21/19,9	C21/21,5	C21/20,8	C21/20,6	C21/20,6	C21/21,4				
20	0,59 150	1,01 270	1,25 335	2,07 580	2,39 670	5,25 1 360	9,66 2 600	13,2 3 550	21,5 5 700	26,5 7 230	41,8 11 060	52,7 14 380	80,4 21 960	106 28 400	134 35 510	184 48 820	209 57 150	20	710		
	CI/19,3	CI/20	CI/20	CI/20,8	CI/20,8	CI/19,3	CI/20	CI/20	CI/19,7	CI/20,3	CI/19,7	CI/20,3	CI/20,3	CI/20	CI/19,7	CI/19,7	CI/20,3				

For n_1 lower than 560 min⁻¹ see page 195.

9 - Selection tables (bevel helical gear reducers)

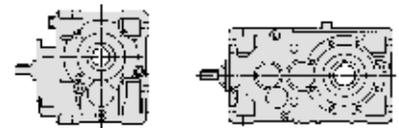

$n_{N2} \cdot L_h$ min ⁻¹ · h	i_N	P_{N2} kW																i_N	n_1	n_{N2}	
		M_{N2} N m																			
		... / i																			
		50	63	64	80	81	100	125	140	160	180	200	225	250	280	320	321	360			
450 000	18	-	-	-	-	-	-	-	12,5 3 420 CI/18	21 5 740 CI/18	25,1 7 090 CI/18,7	42 11 460 CI/18	49,5 14 000 CI/18,7	84,2 22 800 CI/17,9	99,4 27 120 CI/18	128 34 970 CI/18	178 48 700 CI/18	195 54 500 CI/18,4	18	630	35,5
	16	0,59 150 CI/15,2	1,01 270 CI/15,8	1,25 335 CI/15,8	2,07 580 CI/16,4	2,4 670 CI/16,4	5,25 1 360 CI/15,2	9,56 2 570 CI/15,8	13,6 3 640 CI/15,8	21,5 5 700 CI/15,5	30,2 8 250 CI/16	43,4 11 500 CI/15,5	60,5 16 500 CI/16	86,4 23 600 CI/16	116 31 100 CI/15,8	132 36 500 CI/16,3	166 46 170 CI/16,3	245 66 960 CI/16	16	560	
400 000	200	-	-	-	-	-	950 ICI/192	2 240 ICI/199	-	4 450 ICI/196	-	8 750 ICI/196	-	-	-	-	-	-			
	160	-	-	-	-	-	-	-	3 650 C2I/151	5 600 C2I/154	7 750 C2I/158	11 550 C2I/151	15 500 C2I/156	23 000 C2I/156	31 950 C2I/154	38 700 C2I/156	47 500 C2I/156	63 000 C2I/161			
	160	-	-	-	-	-	1 230 ICI/154	2 510 ICI/159	2 810 ICI/159	4 820 ICI/157	5 560 ICI/162	9 450 ICI/157	-	-	-	-	-	-			
	125	-	-	-	-	-	-	-	3 870 C2I/123	6 700 C2I/129	8 770 C2I/130	13 550 C2I/127	16 500 C2I/125	25 440 C2I/123	28 810 C2I/125	44 700 C2I/129	55 870 C2I/129	54 960 C2I/127			
	125	-	-	-	-	-	1 320 ICI/123	2 610 ICI/127	3 540 ICI/127	5 730 ICI/126	7 140 ICI/130	11 560 ICI/126	-	-	-	-	-	-			
	100	-	-	-	-	-	-	-	4 120 C2I/98,2	6 830 C2I/103	9 210 C2I/104	13 560 C2I/102	18 110 C2I/100	27 120 C2I/98,5	31 320 C2I/100	46 910 C2I/103	58 640 C2I/103	62 630 C2I/102			
	100	-	245 ICI/99,4	290 ICI/99,4	500 ICI/103	585 ICI/103	1 290 ICI/100	2 900 ICI/102	3 630 ICI/100	5 860 ICI/106	7 750 ICI/102	11 530 ICI/106	-	-	-	-	-	-			
	90	-	-	-	-	-	-	-	13,1 3 910 C2I/87,8	23 7 100 C2I/90,4	26,6 8 160 C2I/90	48,1 14 420 C2I/87,9	54,9 16 900 C2I/90,3	83,7 25 390 C2I/89	107 32 680 C2I/89,7	-	-	-	90	2800	31,5
	80	-	-	-	-	-	-	-	12,9 3 860 C2I/78,6	21,6 6 840 C2I/82,7	28 8 880 C2I/83,1	43,6 13 560 C2I/81,4	56,5 17 290 C2I/80,2	87,2 26 250 C2I/78,8	105 32 190 C2I/80,3	-	-	-	80	2500	
	80	0,53 155 ICI/75,2	0,84 255 ICI/79,5	1,03 315 ICI/79,5	1,71 540 ICI/82,7	2 630 ICI/82,7	4,18 1 230 ICI/76,7	8,39 2 500 ICI/78,1	9,42 2 810 ICI/78,1	16,6 4 950 ICI/78,1	18,4 5 660 ICI/80,5	34,1 10 170 ICI/78,1	-	-	-	-	-	-	80	2500	
	71	-	-	-	-	-	-	-	13,4 4 020 C2I/70,2	23,3 7 190 C2I/72,3	25,9 7 950 C2I/72	47,1 14 110 C2I/70,3	55,3 17 020 C2I/72,2	80,8 24 520 C2I/71,2	110 33 560 C2I/71,7	140 42 540 C2I/71,1	175 52 940 C2I/71,1	215 67 130 C2I/73,1	71	2240	
	63	-	-	-	-	-	-	-	13,7 4 060 C2I/62	22 6 830 C2I/65,2	29,4 9 210 C2I/65,5	44,2 13 550 C2I/64,2	64,1 19 350 C2I/63,2	91,7 27 190 C2I/62,1	117 35 250 C2I/63,3	151 46 900 C2I/65,1	189 58 630 C2I/65,1	235 71 730 C2I/64	63	2000	
	63	0,53 155 ICI/60,1	0,86 260 ICI/63,6	1,06 320 ICI/63,6	1,76 555 ICI/66,2	2,03 640 ICI/66,2	4,67 1 370 ICI/61,3	8,74 2 610 ICI/62,5	11,4 3 400 ICI/62,5	19,2 5 730 ICI/62,5	23,4 7 190 ICI/64,4	38,7 11 560 ICI/62,5	-	-	-	-	-	-	63	2000	
	56	-	-	-	-	-	-	-	14 4 120 C2I/55,4	24,6 7 430 C2I/57	27,1 8 150 C2I/55,8	49 14 410 C2I/55,5	65,1 19 650 C2I/56,9	93,4 27 810 C2I/56,1	128 38 450 C2I/56,6	149 44 240 C2I/56	186 55 300 C2I/56	225 68 900 C2I/57,6	56	1800	
	50	-	-	-	-	-	-	-	13,5 4 050 C2I/50,4	22 6 830 C2I/52,1	29,4 9 210 C2I/52,4	42,2 13 580 C2I/53,9	61,2 19 380 C2I/53,1	87,5 27 230 C2I/52,1	111 35 300 C2I/53,1	153 46 880 C2I/51,3	191 58 600 C2I/51,3	231 69 510 C2I/50,5	50	1600	
	50	0,56 165 ICI/49	0,97 295 ICI/50,9	1,13 345 ICI/50,9	1,98 625 ICI/53	2,22 700 ICI/53	4,34 1 290 ICI/49,9	9,5 2 840 ICI/50	11,9 3 490 ICI/49,3	19,3 6 050 ICI/52,5	27,4 8 310 ICI/50,8	38,4 12 020 ICI/52,5	-	-	-	-	-	-	50	1600	

For n_1 lower than 560 min⁻¹ see page 195.

9 - Selection tables (bevel helical gear reducers)

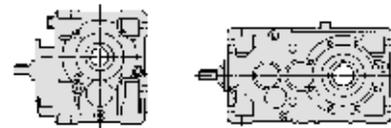

$n_{N2} \cdot L_h$ min ⁻¹ · h	i_N	P_{N2} kW															i_N	n_1	n_{N2}			
		M_{N2} N m																				
		... / i																				
50	63	64	80	81	100	125	140	160	180	200	225	250	280	320	321	360						
400 000	45	-	-	-	-	-	-	13,8 4 250	23,9 7 440	30,1 9 320	45,5 14 440	60 19 560	86,7 27 870	120 38 920	149 45 000	186 56 000	229 71 000	45	1400	31,5		
								C21/45,1	C21/45,6	C21/45,4	C21/46,6	C21/47,8	C21/47,1	C21/47,5	C21/44,2	C21/44,2	C21/45,4					
	40	-	-	-	-	-	-	13,9 4 110	25 7 550	27,8 8 700	46,4 15 100	56,9 18 000	89,2 29 190	112 35 500	150 45 170	187 56 460	227 71 000	40	1250			
									C21/38,7	C21/39,5	C21/41	C21/42,6	C21/41,4	C21/42,8	C21/41,6	C21/39,5	C21/39,5	C21/41				
	40	0,61 180	1,03 315	1,26 385	2,1 670	2,43 775	5,29 1 590	9,58 2 880	10,6 3 250	21,6 6 840	25,4 8 060	40,6 12 840	-	-	-	-	-	40	1250			
									ICI/38,6	ICI/40,1	ICI/40,1	ICI/41,8	ICI/41,8	ICI/39,4	ICI/39,4	ICI/40,2	ICI/41,4	ICI/41,6	ICI/41,4			
	35,5	-	-	-	-	-	-	-	13,3 4 250	23,2 7 400	28,3 9 000	46,7 14 050	58,3 18 000	86,5 27 460	117 37 290	146 45 000	181 56 000	223 71 000	35,5	1120		
									C21/37,5	C21/37,5	C21/37,3	C21/35,3	C21/36,2	C21/37,2	C21/37,5	C21/36,3	C21/36,3	C21/37,3				
	31,5	-	-	-	-	-	-	-	13,5 4 120	21,6 6 840	29 9 210	41,6 13 580	60,3 19 390	86,3 27 250	110 35 320	155 46 410	194 58 020	229 71 000	31,5	1000		
									C21/32	C21/33,1	C21/33,2	C21/34,2	C21/33,7	C21/33,1	C21/33,7	C21/31,3	C21/31,3	C21/32,5				
	31,5	0,62 190	1,06 335	1,23 385	2,05 615	2,33 700	4,73 1 480	8,31 2 570	-	18,5 5 530	-	36,6 11 440	-	-	-	-	-	31,5	1000			
										ICI/31,4		ICI/32,7										
31,5	-	0,78 230	0,86 260	1,52 470	1,89 585	3,69 1 060	6,92 2 060	-	13,5 3 970	-	27,6 8 100	-	55,3 16 770	-	-	-	31,5	1000				
									CI/31,3		CI/30,8		CI/31,7									
28	-	-	-	-	-	-	-	14 4 250	24,2 7 440	32,7 10 000	46,1 14 440	58,3 18 760	87,9 27 860	125 39 810	151 45 000	188 56 000	232 71 000	28	900			
								C21/28,6	C21/28,9	C21/28,8	C21/29,5	C21/30,3	C21/29,9	C21/30,1	C21/28	C21/28	C21/28,8					
25	-	-	-	-	-	-	-	14 4 110	25,4 7 590	29,2 9 060	46,8 15 090	57,4 18 000	90 29 180	117 36 800	150 45 000	187 56 000	229 71 000	25	800			
								C21/24,5	C21/25,1	C21/26	C21/27	C21/26,3	C21/27,2	C21/26,4	C21/25,1	C21/25,1	C21/26					
25	0,53 155	0,87 260	1,09 325	1,87 580	2,16 670	3,86 1 110	8,39 2 500	-	16,8 4 930	-	33,6 9 860	-	67,1 20 340	-	-	-	25	800				
									CI/24,1		CI/24,6		CI/25,4									
22,4	-	-	-	-	-	-	-	13,3 4 250	23,3 7 450	30,9 9 840	47,9 14 420	58,2 18 000	87,7 27 860	120 38 410	145 45 000	181 56 000	223 71 000	22,4	710			
								C21/23,8	C21/23,8	C21/23,7	C21/22,4	C21/23	C21/23,6	C21/23,8	C21/23	C21/23	C21/23,7					
20	-	-	-	-	-	-	-	12,3 3 820	24,4 7 600	28,4 9 210	48,3 15 000	54,3 16 400	89,1 29 000	110 34 840	144 45 000	179 56 000	214 69 360	20	630			
								C21/20,4	C21/20,6	C21/21,4	C21/20,5	C21/19,9	C21/21,5	C21/20,8	C21/20,6	C21/20,6	C21/21,4					
20	0,52 155	0,9 270	1,1 335	1,84 580	2,12 670	4,66 1 360	8,6 2 610	11,7 3 550	19,2 5 730	23,8 7 310	38,4 11 460	47,3 14 530	73,9 22 760	94,7 28 700	120 35 680	164 49 000	187 57 360	20	630			
								CI/19,3	CI/20	CI/20	CI/19,7	CI/20,3	CI/20,3	CI/20	CI/19,7	CI/19,7	CI/20,3					
18	-	-	-	-	-	-	-	11,1 3 420	18,9 5 790	22,3 7 090	37,7 11 570	44 14 000	75,5 23 000	88,4 27 120	115 35 290	159 48 700	174 54 500	18	560			
								CI/18	CI/18	CI/18,7	CI/18	CI/18,7	CI/17,9	CI/18	CI/18	CI/18	CI/18,4					
355 000	200	-	-	-	-	975 ICI/192	2 320 ICI/199	-	4 460 ICI/196	-	9 110 ICI/196	-	-	-	-	-	-					
	160	-	-	-	-	-	-	3 660 C21/151	5 740 C21/154	8 000 C21/158	11 580 C21/151	16 000 C21/156	23 000 C21/156	32 050 C21/154	40 000 C21/156	47 500 C21/156	63 000 C21/161					
	160	-	-	-	-	1 230 ICI/154	2 510 ICI/159	2 820 ICI/159	4 840 ICI/157	5 580 ICI/162	9 750 ICI/157	-	-	-	-	-	-					
	125	-	-	-	-	-	-	3 870 C21/123	6 860 C21/129	8 750 C21/130	13 600 C21/127	17 040 C21/125	26 360 C21/123	29 860 C21/125	46 330 C21/129	57 910 C21/129	56 960 C21/127					

For n_1 lower than 560 min⁻¹ see page 195.

9 - Selection tables (bevel helical gear reducers)

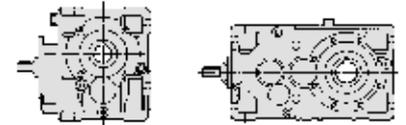

$n_{N2} \cdot L_h$ min ⁻¹ · h	i_N	P_{N2} kW																i_N	n_1	n_{N2} min ⁻¹	
		M_{N2} N m																			
		... / i																			
		50	63	64	80	81	100	125	140	160	180	200	225	250	280	320	321	360			
355 000	125	-	-	-	-	-	1 320 ICI/123	2 620 ICI/127	3 620 ICI/127	5 750 ICI/126	7 170 ICI/130	11 600 ICI/126	-	-	-	-	-	-			
	100	-	-	-	-	-	-	-	12,5 C21/98,2	19,5 C21/103	26,1 C21/104	39,2 C21/102	54 C21/100	81,3 C21/98,5	92,9 C21/100	-	-	-	100	2800	28
	100	-	0,72 245 ICI/99,4	0,86 290 ICI/99,4	1,42 500 ICI/103	1,67 590 ICI/103	3,79 1 300 ICI/100	8,4 2 920 ICI/102	10,7 3 670 ICI/100	16,3 5 880 ICI/106	22,3 7 750 ICI/102	32,1 11 570 ICI/106	-	-	-	-	-	-	100	2800	
	90	-	-	-	-	-	-	-	11,8 3 970 C21/87,8	20,6 7 100 C21/90,4	23,8 8 180 C21/90	43,1 14 470 C21/87,9	50,7 17 480 C21/90,3	77,3 26 270 C21/89	96,7 33 130 C21/89,7	-	-	-	90	2500	
	80	-	-	-	-	-	-	-	11,9 3 990 C21/78,6	19,5 6 860 C21/82,7	25,9 9 180 C21/83,1	39,2 13 610 C21/81,4	52,3 17 870 C21/80,2	80,8 27 130 C21/78,8	95,3 32 620 C21/80,3	134 47 080 C21/82,6	167 58 860 C21/82,6	188 65 230 C21/81,2	80	2240	
	80	0,48 155 ICI/75,2	0,76 255 ICI/79,5	0,93 315 ICI/79,5	1,55 550 ICI/82,7	1,8 635 ICI/82,7	3,76 1 230 ICI/76,7	7,55 2 510 ICI/78,1	8,55 2 850 ICI/78,1	15 5 010 ICI/78,1	16,7 5 730 ICI/80,5	30,9 10 310 ICI/78,1	-	-	-	-	-	-	80	2240	
	71	-	-	-	-	-	-	-	12,1 4 070 C21/70,2	21,5 7 440 C21/72,3	23,8 8 180 C21/72	43,1 14 470 C21/70,3	50 17 250 C21/72,2	74,6 25 370 C21/71,2	99,3 34 020 C21/71,7	127 43 270 C21/71,1	159 54 090 C21/71,1	195 68 040 C21/73,1	71	2000	
	63	-	-	-	-	-	-	-	12,7 4 190 C21/62	19,8 6 860 C21/65,5	26,6 9 240 C21/65,5	39,9 13 600 C21/64,2	57,9 19 410 C21/63,2	82,8 27 280 C21/62,1	105 35 360 C21/63,3	136 47 060 C21/65,1	170 58 820 C21/65,1	218 74 040 C21/64	63	1800	
	63	0,48 155 ICI/60,1	0,78 265 ICI/63,6	0,96 325 ICI/63,6	1,6 565 ICI/66,2	1,85 650 ICI/66,2	4,22 1 370 ICI/61,3	7,89 2 620 ICI/62,5	10,4 3 450 ICI/62,5	17,3 5 750 ICI/62,5	21,3 7 280 ICI/64,4	35 11 600 ICI/62,5	-	-	-	-	-	-	63	1800	
	56	-	-	-	-	-	-	-	12,7 4 180 C21/55,4	21,9 7 460 C21/57	24,1 8 180 C21/56,8	43,7 14 460 C21/55,5	58,4 19 830 C21/56,9	83,3 27 910 C21/56,1	118 39 730 C21/56,6	133 44 410 C21/56	166 55 510 C21/56	203 69 880 C21/57,6	56	1600	
	50	-	-	-	-	-	-	-	12 4 120 C21/50,4	19,3 6 860 C21/52,1	25,9 9 250 C21/52,4	37,1 13 630 C21/53,9	53,7 19 460 C21/53,1	76,9 27 350 C21/52,1	97,8 35 450 C21/53,1	135 47 080 C21/51,3	168 58 840 C21/51,3	210 72 350 C21/50,5	50	1400	
	50	0,5 165 ICI/49	0,85 295 ICI/50,9	1 345 ICI/50,9	1,74 630 ICI/53	1,96 710 ICI/53	3,86 1 310 ICI/49,9	8,54 2 910 ICI/50	10,6 3 550 ICI/49,3	17,2 6 150 ICI/52,5	24,1 8 350 ICI/50,8	34,1 12 210 ICI/52,5	-	-	-	-	-	-	50	1400	
	45	-	-	-	-	-	-	-	12,3 4 250 C21/45,1	21,4 7 470 C21/45,6	27,8 9 640 C21/45,4	40,7 14 490 C21/46,6	55,4 20 240 C21/47,8	77,7 27 970 C21/47,1	110 39 970 C21/47,5	133 45 000 C21/44,2	166 56 000 C21/44,2	205 71 000 C21/45,4	45	1250	
	40	-	-	-	-	-	-	-	12,5 4 140 C21/38,7	22,6 7 620 C21/39,5	25,7 8 990 C21/41	41,7 15 150 C21/42,6	51,3 18 120 C21/41,4	80,2 29 290 C21/42,8	103 36 410 C21/41,6	139 46 680 C21/39,5	173 58 350 C21/39,5	203 71 000 C21/41	40	1120	
	40	0,55 180 ICI/38,6	0,92 315 ICI/40,1	1,13 385 ICI/40,1	1,88 670 ICI/41,8	2,17 775 ICI/41,8	4,76 1 600 ICI/39,4	8,87 2 980 ICI/39,4	9,49 3 250 ICI/40,2	19,4 6 860 ICI/41,4	22,8 8 090 ICI/41,6	36,5 12 880 ICI/41,4	-	-	-	-	-	-	40	1120	
	35,5	-	-	-	-	-	-	-	11,9 4 250 C21/37,5	20,9 7 470 C21/37,5	25,3 9 000 C21/37,3	42,9 14 470 C21/35,3	52 18 000 C21/36,2	78,6 27 960 C21/37,2	108 38 580 C21/37,5	130 45 000 C21/36,3	162 56 000 C21/36,3	199 71 000 C21/37,3	35,5	1000	
31,5	-	-	-	-	-	-	-	12,1 4 120 C21/32	19,5 6 860 C21/33,1	26,2 9 240 C21/33,2	37,6 13 630 C21/34,2	54,5 19 450 C21/33,7	77,9 27 340 C21/33,1	99,1 35 430 C21/33,7	144 47 900 C21/31,3	180 59 880 C21/31,3	206 71 000 C21/32,5	31,5	900		
31,5	0,56 190 ICI/32,1	0,95 335 ICI/33	1,11 385 ICI/33	1,84 615 ICI/31,4	2,16 720 ICI/31,4	4,27 1 490 ICI/32,8	7,61 2 610 ICI/32,4	-	16,6 5 530 ICI/31,4	-	33,1 11 480 ICI/32,7	-	-	-	-	-	-	31,5	900		

For n_1 lower than 560 min⁻¹ see page 195.

9 - Selection tables (bevel helical gear reducers)

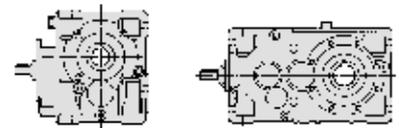

$n_{N2} \cdot L_h$ min ⁻¹ · h	i_N	P_{N2} kW																i_N	n_1	n_{N2}	
		M_{N2} N m																			
		... / i																			
		50	63	64	80	81	100	125	140	160	180	200	225	250	280	320	321	360			
355 000	31,5	-	0,7 235 CI/31,3	0,78 260 CI/31,3	1,37 475 CI/32,5	1,71 590 CI/32,5	3,34 1 070 CI/30,1	6,24 2 070 CI/31,3	-	12,2 3 980 CI/30,8	-	24,9 8 130 CI/30,8	-	50 16 820 CI/31,7	-	-	-	-	31,5	900	28
	28	-	-	-	-	-	-	12,5 4 250 C2I/28,6	21,6 7 460 C2I/28,9	29,2 10 040 C2I/28,8	41,1 14 490 C2I/29,5	53,7 19 430 C2I/30,3	78,4 27 970 C2I/29,9	111 39 950 C2I/30,1	135 45 000 C2I/28	168 56 000 C2I/28	207 71 000 C2I/28,8	28	800		
	25	-	-	-	-	-	-	12,5 4 140 C2I/24,5	22,6 7 620 C2I/25,1	26 9 100 C2I/26	41,7 15 150 C2I/27	51 18 000 C2I/26,3	80,2 29 290 C2I/27,2	108 38 140 C2I/26,4	138 46 410 C2I/25,1	172 58 020 C2I/25,1	203 71 000 C2I/26	25	710		
	25	0,47 155 CI/24,1	0,77 260 CI/25	0,98 330 CI/25	1,66 580 CI/26	1,92 670 CI/26	3,45 1 120 CI/24,1	7,48 2 510 CI/25	-	15 4 980 CI/24,6	-	30,1 9 960 CI/24,6	-	60 20 490 CI/25,4	-	-	-	-	25	710	
	22,4	-	-	-	-	-	-	-	11,8 4 250 C2I/23,8	20,8 7 470 C2I/23,8	28,4 10 190 C2I/23,7	42,7 14 470 C2I/22,4	53 18 470 C2I/23	78,1 27 970 C2I/23,6	110 39 810 C2I/23,8	129 45 000 C2I/23	161 56 000 C2I/23	198 71 000 C2I/23,7	22,4	630	
	20	-	-	-	-	-	-	-	11 3 840 C2I/20,4	21,7 7 630 C2I/20,6	26,2 9 540 C2I/21,4	43 15 000 C2I/20,5	48,8 16 580 C2I/19,9	79,2 29 000 C2I/21,5	102 36 090 C2I/20,8	128 45 000 C2I/20,6	160 56 170 C2I/20,6	192 70 060 C2I/21,4	20	560	
	20	0,47 155 CI/19,3	0,8 270 CI/20	0,98 335 CI/20	1,64 580 CI/20,8	1,89 670 CI/20,8	4,14 1 360 CI/19,3	7,68 2 620 CI/20	10,4 3 550 CI/20	17,1 5 750 CI/19,7	21,4 7 390 CI/20,3	34,2 11 500 CI/19,7	42,4 14 680 CI/20,3	68,1 23 580 CI/20,3	85 29 000 CI/20	108 36 410 CI/19,7	146 49 180 CI/19,7	166 57 580 CI/20,3	20	560	
	315 000	200	-	-	-	-	1000 ICI/192	2 330 ICI/199	-	4 480 ICI/196	-	9 150 ICI/196	-	-	-	-	-	-	-		
160		-	-	-	-	-	-	3 680 C2I/151	5 760 C2I/154	8 000 C2I/158	11 630 C2I/151	16 000 C2I/156	23 940 C2I/156	32 170 C2I/154	40 000 C2I/156	49 350 C2I/156	65 000 C2I/161				
160		-	-	-	-	1 230 ICI/154	2 520 ICI/159	2 830 ICI/159	4 850 ICI/157	5 600 ICI/162	10 100 ICI/157	-	-	-	-	-	-	-			
125		-	-	-	-	-	-	4 000 C2I/123	6 880 C2I/129	8 750 C2I/130	13 650 C2I/127	17 110 C2I/125	27 330 C2I/123	30 950 C2I/125	47 240 C2I/129	59 050 C2I/129	59 040 C2I/127				
125		-	-	-	-	1 380 ICI/123	2 630 ICI/127	3 630 ICI/127	5 770 ICI/126	7 190 ICI/130	11 650 ICI/126	-	-	-	-	-	-	-			
100		-	-	-	-	-	-	11,2 4 210 C2I/98,2	17,4 6 880 C2I/103	23,4 9 280 C2I/104	35,1 13 660 C2I/102	48,4 18 540 C2I/100	72,8 27 400 C2I/98,5	85,9 32 910 C2I/100	-	-	-	-	100	2500	25
100		-	0,64 245 ICI/99,4	0,77 290 ICI/99,4	1,28 505 ICI/103	1,5 590 ICI/103	3,4 1 300 ICI/100	7,53 2 930 ICI/102	9,62 3 690 ICI/100	14,6 5 910 ICI/106	19,9 7 750 ICI/102	28,8 11 610 ICI/106	-	-	-	-	-	-	100	2500	
90		-	-	-	-	-	-	-	10,9 4 080 C2I/87,8	18,9 7 300 C2I/90,4	21,4 8 210 C2I/90	38,7 14 520 C2I/87,9	47 18 070 C2I/90,3	71,6 27 150 C2I/89	87,8 33 560 C2I/89,7	118 44 580 C2I/88,8	147 55 720 C2I/88,8	172 67 130 C2I/91,4	90	2240	
80		-	-	-	-	-	-	-	11 4 130 C2I/78,6	17,4 6 880 C2I/82,7	23,4 9 280 C2I/83,1	35,1 13 660 C2I/81,4	48,3 18 490 C2I/80,2	72,8 27 400 C2I/78,8	86,2 33 060 C2I/80,3	120 47 250 C2I/82,6	150 59 070 C2I/82,6	170 66 120 C2I/81,2	80	2000	
80		0,43 155 ICI/75,2	0,69 260 ICI/79,5	0,85 320 ICI/79,5	1,41 555 ICI/82,7	1,63 640 ICI/82,7	3,37 1 230 ICI/76,7	6,76 2 520 ICI/78,1	7,74 2 890 ICI/78,1	13,6 5 080 ICI/78,1	15,1 5 810 ICI/80,5	28 10 450 ICI/78,1	-	-	-	-	-	-	80	2000	
71		-	-	-	-	-	-	-	11,1 4 120 C2I/70,2	19,5 7 490 C2I/72,3	21,5 8 210 C2I/72	38,9 14 520 C2I/70,3	45,6 17 470 C2I/72,2	69,3 26 190 C2I/71,2	90,5 34 450 C2I/71,7	118 44 570 C2I/71,1	148 55 720 C2I/71,1	178 68 900 C2I/73,1	71	1800	

For n_1 lower than 560 min⁻¹ see page 195.

9 - Selection tables (bevel helical gear reducers)

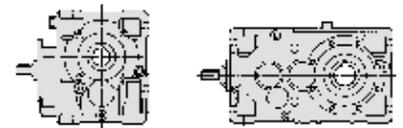

$n_{N2} \cdot L_h$ min ⁻¹ · h	i_N	P_{N2} kW																i_N	n_1	n_{N2}		
		M_{N2} N m																				
		... / i																				
		50	63	64	80	81	100	125	140	160	180	200	225	250	280	320	321	360				
315 000	63	-	-	-	-	-	-	-	11,7 4 340 C21/62	17,7 6 880 C21/65,2	23,7 9 270 C21/65,5	35,6 13 650 C21/64,2	51,6 19 480 C21/63,2	73,9 27 380 C21/62,1	93,9 35 490 C21/63,3	122 47 230 C21/65,1	152 59 040 C21/65,1	201 76 700 C21/64	63	1600	25	
	63	0,43 155 ICI/60,1	0,7 270 ICI/63,6	0,87 330 ICI/63,6	1,45 570 ICI/66,2	1,67 660 ICI/66,2	3,77 1 380 ICI/61,3	7,04 2 630 ICI/62,5	9,5 3 550 ICI/62,5	15,5 5 770 ICI/62,5	19,2 7 380 ICI/64,4	31,2 11 640 ICI/62,5	-	-	-	-	-	-	63	1600		
	56	-	-	-	-	-	-	-	11,3 4 250 C21/55,4	19,3 7 490 C21/57	21,2 8 220 C21/56,8	38,4 14 520 C21/55,5	51,3 19 920 C21/56,9	73,2 28 030 C21/56,1	103 39 900 C21/56,6	118 45 000 C21/56	146 56 000 C21/56	183 71 850 C21/57,6	56	1400		
	50	-	-	-	-	-	-	-	11 4 260 C21/50,4	17,3 6 890 C21/52,1	23,2 9 280 C21/52,4	33,2 13 680 C21/53,9	48,2 19 530 C21/53,1	68,9 27 450 C21/52,1	87,6 35 570 C21/53,1	121 47 240 C21/51,3	151 59 050 C21/51,3	194 74 850 C21/50,5	50	1250		
	50	0,44 165 ICI/49	0,76 295 ICI/50,9	0,89 345 ICI/50,9	1,56 630 ICI/53	1,76 710 ICI/53	3,46 1 320 ICI/49,9	7,66 2 920 ICI/50	9,58 3 610 ICI/49,3	15,3 6 150 ICI/52,5	21,6 8 380 ICI/50,8	30,8 12 330 ICI/52,5	-	-	-	-	-	-	50	1250		
	45	-	-	-	-	-	-	-	11,1 4 250 C21/45,1	19,3 7 490 C21/45,6	25,7 9 960 C21/45,4	36,6 14 540 C21/46,6	50,6 20 600 C21/47,8	69,9 28 070 C21/47,1	99 40 100 C21/47,5	120 45 000 C21/44,2	149 56 000 C21/44,2	183 71 000 C21/45,4	45	1120		
	40	-	-	-	-	-	-	-	11,3 4 160 C21/38,7	20,3 7 650 C21/39,5	23,3 9 130 C21/41	37,4 15 200 C21/42,6	47,4 18 750 C21/41,4	71,9 29 390 C21/42,8	94,9 37 670 C21/41,6	128 48 300 C21/39,5	160 60 370 C21/39,5	181 71 000 C21/41	40	1000		
	40	0,49 180 ICI/38,6	0,82 315 ICI/40,1	1,01 385 ICI/40,1	1,68 670 ICI/41,8	1,94 775 ICI/41,8	4,26 1 600 ICI/39,4	8,19 3 080 ICI/39,4	8,47 3 250 ICI/40,2	17,4 6 880 ICI/41,4	20,4 8 120 ICI/41,6	32,7 12 930 ICI/41,4	-	-	-	-	-	-	40	1000		
	35,5	-	-	-	-	-	-	-	10,7 4 250 C21/37,5	18,9 7 500 C21/37,5	22,7 9 000 C21/37,3	38,8 14 520 C21/35,3	46,8 18 000 C21/36,2	71 28 060 C21/37,2	99,3 39 530 C21/37,5	117 45 000 C21/36,3	146 56 000 C21/36,3	179 71 000 C21/37,3	35,5	900		
	31,5	-	-	-	-	-	-	-	10,8 4 120 C21/32	17,4 6 880 C21/33,1	23,4 9 280 C21/33,2	33,5 13 680 C21/34,2	48,6 19 520 C21/33,7	69,5 27 440 C21/33,1	88,4 35 560 C21/33,7	133 49 630 C21/31,3	166 62 030 C21/31,3	183 71 000 C21/32,5	31,5	800		
	31,5	0,5 190 ICI/32,1	0,85 335 ICI/33	0,98 385 ICI/33	1,66 625 ICI/31,4	1,95 730 ICI/31,4	3,81 1 490 ICI/32,8	7,01 2 710 ICI/32,4	-	14,8 5 530 ICI/31,4	-	29,5 11 530 ICI/32,7	-	-	-	-	-	-	31,5	800		
	31,5	-	0,63 235 CI/31,3	0,7 260 CI/31,3	1,22 475 CI/32,5	1,52 590 CI/32,5	2,98 1 070 CI/30,1	5,57 2 080 CI/31,3	-	10,9 4 000 CI/30,8	-	22,2 8 160 CI/30,8	-	44,6 16 880 CI/31,7	-	-	-	-	31,5	800		
	28	-	-	-	-	-	-	-	11,1 4 250 C21/28,6	19,3 7 490 C21/28,9	26 10 080 C21/28,8	36,6 14 540 C21/29,5	49,4 20 140 C21/30,3	69,8 28 070 C21/29,9	99 40 110 C21/30,1	119 45 000 C21/28	149 56 000 C21/28	183 71 000 C21/28,8	28	710		
	25	-	-	-	-	-	-	-	11,2 4 160 C21/24,5	20,1 7 650 C21/25,1	23,2 9 130 C21/26	37,1 15 210 C21/27	45,4 18 080 C21/26,3	71,4 29 400 C21/27,2	99 39 530 C21/26,4	127 48 110 C21/25,1	158 60 130 C21/25,1	180 71 000 C21/26	25	630		
	25	0,42 155 CI/24,1	0,69 260 CI/25	0,87 330 CI/25	1,47 580 CI/26	1,7 670 CI/26	3,07 1 120 CI/24,1	6,66 2 520 CI/25	-	13,5 5 030 CI/24,6	-	26,9 10 050 CI/24,6	-	53,8 20 700 CI/25,4	-	-	-	-	25	630		
22,4	-	-	-	-	-	-	-	10,5 4 250 C21/23,8	18,5 7 500 C21/23,8	25,3 10 220 C21/23,7	38 14 500 C21/22,4	48,8 19 140 C21/23	69,5 28 000 C21/23,6	98,6 40 000 C21/23,8	115 45 000 C21/23	143 56 000 C21/23	176 71 000 C21/23,7	22,4	560			
280 000	200	-	-	-	-	1000 ICI/192	2 340 ICI/199	-	4 490 ICI/196	-	9 180 ICI/196	-	-	-	-	-	-	-				
	160	-	-	-	-	-	-	3 690 C21/151	5 790 C21/154	8 250 C21/158	11 670 C21/151	16 500 C21/156	24 030 C21/156	32 290 C21/154	41 200 C21/156	49 530 C21/156	65 000 C21/161					

For n_1 lower than 560 min⁻¹ see page 195.

9 - Selection tables (bevel helical gear reducers)

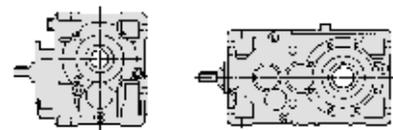

$n_{N2} \cdot L_h$ min ⁻¹ · h	i_N	P_{N2} kW																i_N	n_1	n_{N2} min ⁻¹		
		M_{N2} N m																				
		... / i																				
		50	63	64	80	81	100	125	140	160	180	200	225	250	280	320	321	360				
280 000	160	-	-	-	-	-	1 240 ICI/154	2 530 ICI/159	2 840 ICI/159	4 870 ICI/157	5 620 ICI/162	10 470 ICI/157	-	-	-	-	-	-	-	-	-	-
	125	-	-	-	-	-	-	-	9,81 4 110 C2I/123	15,7 6 910 C2I/129	20,6 9 110 C2I/130	31,6 13 700 C2I/127	40,2 17 170 C2I/125	65,5 27 490 C2I/123	74,9 32 060 C2I/125	-	47 420 C2I/129	59 270 C2I/129	61 170 C2I/127	125	2800	22,4
	125	-	-	-	-	-	3,3 1 380 ICI/123	6,08 2 640 ICI/127	8,4 3 640 ICI/127	13,5 5 790 ICI/126	16,3 7 220 ICI/130	27,3 11 690 ICI/126	-	-	-	-	-	-	-	125	2800	
	100	-	-	-	-	-	-	-	10,1 4 230 C2I/98,2	15,7 6 910 C2I/103	21 9 310 C2I/104	31,6 13 700 C2I/102	43,5 18 600 C2I/100	65,5 27 490 C2I/98,5	79,5 34 020 C2I/100	108 47 420 C2I/103	135 59 270 C2I/103	153 66 360 C2I/102	100	2240		
	100	-	0,58 245 ICI/99,4	0,69 290 ICI/99,4	1,15 505 ICI/103	1,35 595 ICI/103	3,05 1 300 ICI/100	6,77 2 940 ICI/102	8,65 3 700 ICI/100	13,2 5 930 ICI/106	18,4 8 000 ICI/102	26,1 11 760 ICI/106	-	-	-	-	-	-	-	100	2240	
	90	-	-	-	-	-	-	-	10,1 4 220 C2I/87,8	17,4 7 520 C2I/90,4	19,2 8 240 C2I/90	34,7 14 570 C2I/87,9	43,4 18 690 C2I/90,3	66,1 28 090 C2I/89	79,5 34 020 C2I/89,7	105 44 740 C2I/88,8	132 55 920 C2I/88,8	156 68 040 C2I/91,4	90	2000		
	80	-	-	-	-	-	-	-	10,2 4 260 C2I/78,6	15,7 6 910 C2I/82,7	21,1 9 310 C2I/83,1	31,7 13 700 C2I/81,4	44,9 19 090 C2I/80,2	65,8 27 490 C2I/78,8	78,6 33 480 C2I/80,3	108 47 410 C2I/82,6	135 59 260 C2I/82,6	155 66 960 C2I/81,2	80	1800		
	80	0,39 155 ICI/75,2	0,63 265 ICI/79,5	0,77 325 ICI/79,5	1,28 565 ICI/82,7	1,48 650 ICI/82,7	3,04 1 240 ICI/76,7	6,11 2 530 ICI/78,1	7,06 2 920 ICI/78,1	12,4 5 140 ICI/78,1	13,8 5 880 ICI/80,5	25,5 10 580 ICI/78,1	-	-	-	-	-	-	-	80	1800	
	71	-	-	-	-	-	-	-	9,98 4 180 C2I/70,2	17,4 7 520 C2I/72,3	19,2 8 240 C2I/72	34,7 14 570 C2I/70,3	41,3 17 810 C2I/72,2	63,8 27 130 C2I/71,2	81,6 34 940 C2I/71,7	105 44 740 C2I/71,1	132 55 920 C2I/71,1	160 69 880 C2I/73,1	71	1600		
	63	-	-	-	-	-	-	-	10,7 4 520 C2I/62	15,5 6 910 C2I/65,2	20,8 9 310 C2I/65,5	31,3 13 710 C2I/64,2	45,4 19 570 C2I/63,2	64,9 27 500 C2I/62,1	82,5 35 640 C2I/63,3	107 47 430 C2I/65,1	133 59 290 C2I/65,1	177 77 470 C2I/64	63	1400		
	63	0,38 155 ICI/60,1	0,63 270 ICI/63,6	0,77 335 ICI/63,6	1,28 580 ICI/66,2	1,48 670 ICI/66,2	3,31 1 380 ICI/61,3	6,18 2 640 ICI/62,5	8,54 3 640 ICI/62,5	13,6 5 790 ICI/62,5	17,1 7 500 ICI/64,4	27,4 11 690 ICI/62,5	-	-	-	-	-	-	-	63	1400	
	56	-	-	-	-	-	-	-	10 4 250 C2I/55,4	17,3 7 520 C2I/57	19 8 250 C2I/56,8	34,4 14 570 C2I/55,5	46 19 990 C2I/56,9	65,6 28 130 C2I/56,1	92,7 40 040 C2I/56,6	105 45 000 C2I/56	131 56 000 C2I/56	169 74 330 C2I/57,6	56	1250		
	50	-	-	-	-	-	-	-	10,2 4 400 C2I/50,4	15,5 6 910 C2I/52,1	20,8 9 310 C2I/52,4	29,9 13 730 C2I/53,9	43,3 19 600 C2I/53,1	61,9 27 540 C2I/52,1	78,8 35 700 C2I/53,1	108 47 410 C2I/51,3	135 59 260 C2I/51,3	180 77 360 C2I/50,5	50	1120		
	50	0,4 165 ICI/49	0,68 295 ICI/50,9	0,8 350 ICI/50,9	1,4 635 ICI/53	1,58 715 ICI/53	3,1 1 320 ICI/49,9	6,88 2 930 ICI/50	8,8 3 700 ICI/49,3	13,7 6 150 ICI/52,5	19,4 8 400 ICI/50,8	27,8 12 440 ICI/52,5	-	-	-	-	-	-	-	50	1120	
	45	-	-	-	-	-	-	-	9,87 4 250 C2I/45,1	17,3 7 520 C2I/45,6	23,3 10 110 C2I/45,4	32,8 14 600 C2I/46,6	45,3 20 680 C2I/47,8	62,6 28 170 C2I/47,1	88,7 40 250 C2I/47,5	107 45 000 C2I/44,2	133 56 000 C2I/44,2	166 72 030 C2I/45,4	45	1000		
	40	-	-	-	-	-	-	-	10,2 4 180 C2I/38,7	18,3 7 670 C2I/39,5	21,1 9 160 C2I/41	33,8 15 250 C2I/42,6	44 19 350 C2I/41,4	64,9 29 490 C2I/42,8	88,2 38 880 C2I/41,6	119 49 850 C2I/39,5	149 62 310 C2I/39,5	163 71 000 C2I/41	40	900		
40	0,45 180 ICI/38,6	0,74 315 ICI/40,1	0,91 385 ICI/40,1	1,51 670 ICI/41,8	1,75 775 ICI/41,8	3,85 1 610 ICI/39,4	7,54 3 160 ICI/39,4	7,62 3 250 ICI/40,2	15,7 6 910 ICI/41,4	18,5 8 140 ICI/41,6	29,5 12 970 ICI/41,4	-	-	-	-	-	-	-	40	900		
35,5	-	-	-	-	-	-	-	9,49 4 250 C2I/37,5	16,8 7 530 C2I/37,5	20,3 9 050 C2I/37,3	34,6 14 570 C2I/35,3	41,6 18 000 C2I/36,2	63,3 28 160 C2I/37,2	88,6 39 680 C2I/37,5	104 45 000 C2I/36,3	129 56 000 C2I/36,3	159 71 000 C2I/37,3	35,5	800			

For n_1 lower than 560 min⁻¹ see page 195.

9 - Selection tables (bevel helical gear reducers)

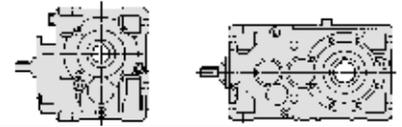

$n_{N2} \cdot L_h$ min ⁻¹ · h	i_N	P_{N2} kW																i_N	n_1 min ⁻¹	n_{N2} min ⁻¹		
		M_{N2} N m																				
		...																				
		I_i																				
		50	63	64	80	81	100	125	140	160	180	200	225	250	280	320	321	360				
280 000	31,5	-	-	-	-	-	-	-	9,87 4 250 C2I/32	15,5 6 910 C2I/33,1	20,8 9 310 C2I/33,2	29,9 13 730 C2I/34,2	43,3 19 600 C2I/33,7	61,9 27 540 C2I/33,1	78,7 35 700 C2I/33,7	120 50 640 C2I/31,3	150 63 300 C2I/31,3	162 71 000 C2I/32,5	31,5	710	22,4	
	31,5	0,44 190 ICI/32,1	0,76 335 ICI/33	0,87 385 ICI/33	1,48 625 ICI/31,4	1,74 735 ICI/31,4	3,39 1 500 ICI/32,8	6,45 2 810 ICI/32,4	-	13,1 5 530 ICI/31,4	-	26,3 11 570 ICI/32,7	-	-	-	-	-	-	31,5	710		
	31,5	-	0,56 235 CI/31,3	0,62 260 CI/31,3	1,09 475 CI/32,5	1,36 595 CI/32,5	2,65 1 070 CI/30,1	4,96 2 090 CI/31,3	-	9,66 4 000 CI/30,8	-	19,8 8 190 CI/30,8	-	39,7 16 950 CI/31,7	-	-	-	-	-	31,5		710
	28	-	-	-	-	-	-	-	9,81 4 250 C2I/28,6	17,2 7 520 C2I/28,9	23,2 10 120 C2I/28,8	32,6 14 600 C2I/29,5	45 20 680 C2I/30,3	62,2 28 180 C2I/29,9	88,2 40 260 C2I/30,1	106 45 000 C2I/28	132 56 000 C2I/28	163 71 000 C2I/28,8	28	630		
	25	-	-	-	-	-	-	-	10 4 190 C2I/24,5	18 7 680 C2I/25,1	20,7 9 170 C2I/26	33,1 15 260 C2I/27	41,8 18 730 C2I/26,3	63,7 29 510 C2I/27,2	89 40 000 C2I/26,4	117 49 840 C2I/25,1	146 62 300 C2I/25,1	160 71 000 C2I/26	25	560		
	25	0,38 155 CI/24,1	0,61 260 CI/25	0,78 330 CI/25	1,31 580 CI/26	1,51 670 CI/26	2,73 1 120 CI/24,1	5,94 2 530 CI/25	-	12,1 5 070 CI/24,6	-	24,2 10 150 CI/24,6	-	48,3 20 920 CI/25,4	-	-	-	-	-	25		560
250 000	200	-	-	-	-	1 030 ICI/192	2 350 ICI/199	-	4 510 ICI/196	-	9 210 ICI/196	-	-	-	-	-	-	-	-	-	-	
	160	-	-	-	-	-	-	3 710 C2I/151	5 810 C2I/154	8 430 C2I/158	11 710 C2I/151	16 890 C2I/156	24 120 C2I/156	32 410 C2I/154	42 260 C2I/156	49 720 C2I/156	67 000 C2I/161	-	-	-	-	
	160	-	-	-	-	1 240 ICI/154	2 540 ICI/159	2 850 ICI/159	4 890 ICI/157	5 640 ICI/162	10 850 ICI/157	-	-	-	-	-	-	-	-	-	-	
	125	-	-	-	-	-	-	8,79 4 120 C2I/123	14,1 6 930 C2I/129	18,4 9 140 C2I/130	28,3 13 750 C2I/127	36 17 230 C2I/125	58,7 27 590 C2I/123	69,2 33 170 C2I/125	-	-	-	-	125	2500	20	
	125	-	-	-	-	2,96 1 390 ICI/123	5,45 2 650 ICI/127	7,53 3 660 ICI/127	12,1 5 810 ICI/126	14,6 7 250 ICI/130	24,4 11 730 ICI/126	-	-	-	-	-	-	125	2500			
	100	-	-	-	-	-	-	9,05 4 240 C2I/98,2	14,1 6 930 C2I/103	18,8 9 340 C2I/104	28,3 13 750 C2I/102	39 18 670 C2I/100	58,7 27 590 C2I/98,5	73,4 35 190 C2I/100	96,5 47 590 C2I/103	121 59 480 C2I/103	142 68 650 C2I/102	100	2000			
	100	-	0,52 245 ICI/99,4	0,62 295 ICI/99,4	1,03 505 ICI/103	1,21 595 ICI/103	2,74 1 310 ICI/100	6,07 2 950 ICI/102	7,75 3 710 ICI/100	11,8 5 950 ICI/106	16,4 8 000 ICI/102	23,6 11 920 ICI/106	-	-	-	-	-	-	100	2000		
	90	-	-	-	-	-	-	9,15 4 260 C2I/87,8	15,7 7 540 C2I/90,4	17,3 8 270 C2I/90	31,3 14 620 C2I/87,9	39,5 18 900 C2I/90,3	59,8 28 210 C2I/89	72,4 34 450 C2I/89,7	95,2 44 890 C2I/88,8	119 56 110 C2I/88,8	142 68 900 C2I/91,4	90	1800			
	80	-	-	-	-	-	-	9,41 4 410 C2I/78,6	14,1 6 930 C2I/82,7	18,8 9 340 C2I/83,1	28,3 13 750 C2I/81,4	41 19 630 C2I/80,2	58,7 27 590 C2I/78,8	70,9 33 990 C2I/80,3	96,5 47 590 C2I/82,6	121 59 480 C2I/82,6	140 67 910 C2I/81,2	80	1600			
	80	0,35 155 ICI/75,2	0,56 270 ICI/79,5	0,69 330 ICI/79,5	1,16 570 ICI/82,7	1,34 660 ICI/82,7	2,72 1 240 ICI/76,7	5,45 2 540 ICI/78,1	6,36 2 970 ICI/78,1	11,2 5 220 ICI/78,1	12,4 5 970 ICI/80,5	23 10 730 ICI/78,1	-	-	-	-	-	-	80	1600		
	71	-	-	-	-	-	-	8,87 4 250 C2I/70,2	15,3 7 550 C2I/72,3	16,9 8 290 C2I/72	30,5 14 630 C2I/70,3	37,6 18 530 C2I/72,2	58,1 28 240 C2I/71,2	72,5 35 500 C2I/71,7	92,8 45 000 C2I/71,1	116 56 160 C2I/71,1	142 71 000 C2I/73,1	71	1400			
	63	-	-	-	-	-	-	9,75 4 610 C2I/62	13,9 6 930 C2I/65,2	18,7 9 350 C2I/65,5	28,1 13 760 C2I/64,2	40,7 19 640 C2I/63,2	58,2 27 600 C2I/62,1	74 35 770 C2I/63,3	95,7 47 600 C2I/65,1	120 59 500 C2I/65,1	159 77 740 C2I/64	63	1250			

For n_1 lower than 560 min⁻¹ see page 195.

9 - Selection tables (bevel helical gear reducers)

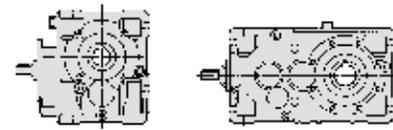

$n_{N2} \cdot L_h$ min ⁻¹ · h	i_N	P_{N2} kW																i_N	n_1	n_{N2}		
		M_{N2} N m																				
		... / i																				
		50	63	64	80	81	100	125	140	160	180	200	225	250	280	320	321	360				
250 000	63	0,34 155 ICI/60,1	0,56 270 ICI/63,6	0,69 335 ICI/63,6	1,15 580 ICI/66,2	1,33 670 ICI/66,2	2,97 1 390 ICI/61,3	5,54 2 650 ICI/62,5	7,66 3 660 ICI/62,5	12,2 5 810 ICI/62,5	15,2 7 500 ICI/64,4	24,6 11 730 ICI/62,5	-	-	-	-	-	-	63	1250	20	
	56	-	-	-	-	-	-	-	9,14 4 320 C2I/55,4	15,5 7 540 C2I/57	17,1 8 280 C2I/56,8	30,9 14 620 C2I/55,5	41,3 20 060 C2I/56,9	59 28 230 C2I/56,1	83,3 40 180 C2I/56,6	94,2 45 000 C2I/56	117 56 130 C2I/56	156 76 820 C2I/57,6	56	1120		
	50	-	-	-	-	-	-	-	9,45 4 550 C2I/50,4	13,9 6 930 C2I/52,1	18,7 9 350 C2I/52,4	26,8 13 780 C2I/53,9	38,8 19 670 C2I/53,1	55,5 27 640 C2I/52,1	70,6 35 830 C2I/53,1	97,1 47 580 C2I/51,3	121 59 470 C2I/51,3	161 77 700 C2I/50,5	50	1000		
	50	0,36 165 ICI/49	0,61 300 ICI/50,9	0,72 350 ICI/50,9	1,26 635 ICI/53	1,41 715 ICI/53	2,77 1 320 ICI/49,9	6,17 2 940 ICI/50	7,88 3 710 ICI/49,3	12,3 6 150 ICI/52,5	17,4 8 430 ICI/50,8	24,8 12 440 ICI/52,5	-	-	-	-	-	-	50	1000		
	45	-	-	-	-	-	-	-	8,89 4 250 C2I/45,1	15,6 7 540 C2I/45,6	21,1 10 150 C2I/45,4	29,6 14 640 C2I/46,6	40,9 20 750 C2I/47,8	56,5 28 260 C2I/47,1	80,1 40 380 C2I/47,5	96 45 000 C2I/44,2	120 56 100 C2I/44,2	154 74 350 C2I/45,4	45	900		
	40	-	-	-	-	-	-	-	9,12 4 210 C2I/38,7	16,4 7 750 C2I/39,5	18,8 9 200 C2I/41	30,4 15 460 C2I/42,6	40,3 19 920 C2I/41,4	58,5 29 900 C2I/42,8	81,2 40 280 C2I/41,6	108 51 130 C2I/39,5	135 63 910 C2I/39,5	145 71 000 C2I/41	40	800		
	40	0,4 185 ICI/38,6	0,66 315 ICI/40,1	0,81 385 ICI/40,1	1,34 670 ICI/41,8	1,55 775 ICI/41,8	3,43 1 610 ICI/39,4	6,73 3 170 ICI/39,4	7,01 3 360 ICI/40,2	14 6 930 ICI/41,4	16,5 8 170 ICI/41,6	26,4 13 020 ICI/41,4	-	-	-	-	-	-	40	800		
	35,5	-	-	-	-	-	-	-	8,42 4 250 C2I/37,5	15 7 550 C2I/37,5	18,7 9 380 C2I/37,3	30,8 14 630 C2I/35,3	37,7 18 380 C2I/36,2	56,4 28 270 C2I/37,2	78,9 39 820 C2I/37,5	92,2 45 000 C2I/36,3	115 56 170 C2I/36,3	144 72 300 C2I/37,3	35,5	710		
	31,5	-	-	-	-	-	-	-	9,08 4 400 C2I/32	13,8 6 940 C2I/33,1	18,6 9 350 C2I/33,2	26,6 13 780 C2I/34,2	38,6 19 670 C2I/33,7	55,2 27 650 C2I/33,1	70,1 35 830 C2I/33,7	108 51 180 C2I/31,3	135 63 970 C2I/31,3	144 71 000 C2I/32,5	31,5	630		
	31,5	0,39 190 ICI/32,1	0,67 335 ICI/33	0,77 385 ICI/33	1,32 630 ICI/31,4	1,55 740 ICI/31,4	3,02 1 500 ICI/32,8	5,93 2 910 ICI/32,4	-	11,6 5 530 ICI/31,4	-	23,4 11 610 ICI/32,7	-	-	-	-	-	-	31,5	630		
	31,5	-	0,5 235 CI/31,3	0,55 260 CI/31,3	0,97 480 CI/32,5	1,21 595 CI/32,5	2,36 1 080 CI/30,1	4,42 2 090 CI/31,3	-	8,58 4 000 CI/30,8	-	17,6 8 220 CI/30,8	-	35,3 17 000 CI/31,7	-	-	-	-	31,5	630		
	28	-	-	-	-	-	-	-	8,72 4 250 C2I/28,6	15,3 7 550 C2I/28,9	20,7 10 150 C2I/28,8	29,1 14 650 C2I/29,5	40,2 20 760 C2I/30,3	55,5 28 280 C2I/29,9	78,7 40 410 C2I/30,1	94,2 45 000 C2I/28	117 56 000 C2I/28	146 71 580 C2I/28,8	28	560		
224 000	200	-	-	-	-	1 030 ICI/192	2 350 ICI/199	-	4 530 ICI/196	-	9 250 ICI/196	-	-	-	-	-	-	-	-	-	-	
	160	-	-	-	-	-	-	7,24 3 720 C2I/151	11,1 5 830 C2I/154	15,7 8 460 C2I/158	22,8 11 760 C2I/151	31,8 16 950 C2I/156	45,4 24 210 C2I/156	62 32 540 C2I/154	-	42 420 C2I/156	49 900 C2I/156	67 000 C2I/161	160	2800	18	
	160	-	-	-	-	2,38 1 250 ICI/154	4,71 2 550 ICI/159	5,27 2 860 ICI/159	9,16 4 910 ICI/157	10,3 5 660 ICI/162	20,9 11 180 ICI/157	-	-	-	-	-	-	-	160	2800		
	125	-	-	-	-	-	-	7,9 4 140 C2I/123	12,6 6 960 C2I/129	16,6 9 170 C2I/130	25,5 13 800 C2I/127	32,4 17 290 C2I/125	52,8 27 690 C2I/123	64,1 34 280 C2I/125	86,8 47 750 C2I/129	108 59 690 C2I/129	121 65 400 C2I/127	125	2240			
	125	-	-	-	-	2,66 1 390 ICI/123	4,9 2 660 ICI/127	6,77 3 670 ICI/127	10,9 5 830 ICI/126	13,2 7 270 ICI/130	22 11 770 ICI/126	-	-	-	-	-	-	-	125	2240		
	100	-	-	-	-	-	-	8,17 4 260 C2I/98,2	12,7 6 960 C2I/103	17 9 370 C2I/104	25,6 13 800 C2I/102	35,2 18 730 C2I/100	53 27 680 C2I/98,5	67,4 35 880 C2I/100	87,2 47 740 C2I/103	109 59 680 C2I/103	132 70 860 C2I/102	100	1800			

For n_1 lower than 560 min⁻¹ see page 195.

9 - Selection tables (bevel helical gear reducers)

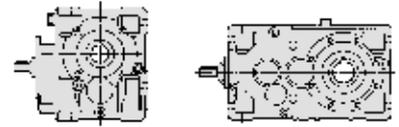

$n_{N2} \cdot L_h$ min ⁻¹ · h	i_N	P_{N2} kW																i_N	n_1	n_{N2} min ⁻¹		
		M_{N2} N m																				
		... / i																				
		50	63	64	80	81	100	125	140	160	180	200	225	250	280	320	321	360				
224 000	100	-	0,47 245 ICI/99,4	0,56 295 ICI/99,4	0,93 510 ICI/103	1,09 600 ICI/103	2,47 1 310 ICI/100	5,48 2 960 ICI/102	7 3 720 ICI/100	10,7 5 970 ICI/106	15,2 8 250 ICI/102	21,5 12 070 ICI/106	-	-	-	-	-	-	100	1800	18	
	90	-	-	-	-	-	-	8,17 4 280 C21/87,8	14,1 7 610 C21/90,4	15,5 8 300 C21/90	28 14 720 C21/87,9	35,2 18 970 C21/90,3	53,5 28 400 C21/89	65,3 34 940 C21/89,7	85,5 45 360 C21/88,8	107 56 700 C21/88,8	128 69 880 C21/91,4	90	1600			
	80	-	-	-	-	-	-	8,57 4 590 C21/78,6	12,3 6 960 C21/82,7	16,6 9 380 C21/83,1	24,9 13 810 C21/81,4	36 19 710 C21/80,2	51,6 27 710 C21/78,8	64,6 35 380 C21/80,3	84,8 47 790 C21/82,6	106 59 730 C21/82,6	125 69 000 C21/81,2	80	1400			
	80	0,3 155 ICI/75,2	0,5 270 ICI/79,5	0,62 335 ICI/79,5	1,03 580 ICI/82,7	1,19 670 ICI/82,7	2,39 1 250 ICI/76,7	4,79 2 550 ICI/78,1	5,63 3 000 ICI/78,1	9,94 5 300 ICI/78,1	10,9 6 000 ICI/80,5	20,8 11 060 ICI/78,1	-	-	-	-	-	-	80	1400		
	71	-	-	-	-	-	-	-	7,92 4 250 C21/70,2	13,8 7 630 C21/72,3	15,2 8 340 C21/72	27,5 14 770 C21/70,3	34,8 19 180 C21/72,2	52,4 28 510 C21/71,2	64,8 35 500 C21/71,7	83,8 45 520 C21/71,1	105 56 900 C21/71,1	127 71 000 C21/73,1	71	1250		
	63	-	-	-	-	-	-	-	8,77 4 630 C21/62	12,5 6 960 C21/65,2	16,8 9 380 C21/65,5	25,2 13 800 C21/64,2	36,6 19 700 C21/63,2	52,3 27 690 C21/62,1	66,5 35 890 C21/63,3	86 47 760 C21/65,1	108 59 710 C21/65,1	143 78 010 C21/64	63	1120		
	63	0,3 155 ICI/60,1	0,5 270 ICI/63,6	0,62 335 ICI/63,6	1,03 580 ICI/66,2	1,19 670 ICI/66,2	2,67 1 390 ICI/61,3	4,98 2 660 ICI/62,5	6,88 3 670 ICI/62,5	10,9 5 830 ICI/62,5	13,7 7 500 ICI/64,4	22,1 11 770 ICI/62,5	-	-	-	-	-	-	63	1120		
	56	-	-	-	-	-	-	-	8,41 4 450 C21/55,4	14 7 620 C21/57	15,4 8 330 C21/55,5	27,8 14 740 C21/55,5	37 20 130 C21/56,9	53,1 28 440 C21/56,1	74,6 40 320 C21/56,6	84,9 45 420 C21/56	106 56 780 C21/56	144 79 480 C21/57,6	56	1000		
	50	-	-	-	-	-	-	-	8,65 4 630 C21/50,4	12,6 6 960 C21/52,1	16,9 9 380 C21/52,4	24,2 13 820 C21/53,9	35 19 730 C21/53,1	50,1 27 730 C21/52,1	63,7 35 940 C21/53,1	87,7 47 730 C21/51,3	110 59 670 C21/51,3	146 77 960 C21/50,5	50	900		
	50	0,32 170 ICI/49	0,55 300 ICI/50,9	0,65 350 ICI/50,9	1,13 640 ICI/53	1,27 715 ICI/53	2,49 1 320 ICI/49,9	5,57 2 950 ICI/50	7,12 3 720 ICI/49,3	11 6 150 ICI/52,5	15,7 8 460 ICI/50,8	22,3 12 440 ICI/52,5	-	-	-	-	-	-	50	900		
	45	-	-	-	-	-	-	-	8,08 4 350 C21/45,1	14 7 620 C21/45,6	18,8 10 190 C21/45,4	26,7 14 850 C21/46,6	36,9 21 030 C21/47,8	50,9 28 650 C21/47,1	72,2 40 940 C21/47,5	86 45 320 C21/44,2	107 56 650 C21/44,2	142 77 020 C21/45,4	45	800		
	40	-	-	-	-	-	-	-	8,15 4 240 C21/38,7	14,6 7 750 C21/39,5	16,7 9 230 C21/41	27,1 15 500 C21/42,6	35,9 19 990 C21/41,4	52,8 30 440 C21/42,8	72,4 40 450 C21/41,6	97,9 52 060 C21/39,5	122 65 070 C21/39,5	131 72 070 C21/41	40	710		
	40	0,35 185 ICI/38,6	0,58 315 ICI/40,1	0,72 385 ICI/40,1	1,19 670 ICI/41,8	1,38 775 ICI/41,8	3,06 1 620 ICI/39,4	6 3 180 ICI/39,4	6,45 3 480 ICI/40,2	12,5 6 960 ICI/41,4	14,7 8 210 ICI/41,6	23,5 13 070 ICI/41,4	-	-	-	-	-	-	40	710		
	35,5	-	-	-	-	-	-	-	7,49 4 260 C21/37,5	13,5 7 670 C21/37,5	17,2 9 730 C21/37,3	27,6 14 760 C21/35,3	34,7 19 050 C21/36,2	50,8 28 670 C21/37,2	70,3 39 970 C21/37,5	83 45 610 C21/36,3	104 57 010 C21/36,3	133 74 940 C21/37,3	35,5	630		
	31,5	-	-	-	-	-	-	-	8,36 4 560 C21/32	12,3 6 960 C21/33,1	16,6 9 380 C21/33,2	23,7 13 830 C21/34,2	34,4 19 740 C21/33,7	49,2 27 750 C21/33,1	62,6 35 970 C21/33,7	97,5 52 100 C21/31,3	122 65 120 C21/31,3	129 71 610 C21/32,5	31,5	560		
	31,5	0,35 195 ICI/32,1	0,6 335 ICI/33	0,69 385 ICI/33	1,17 630 ICI/31,4	1,38 740 ICI/31,4	2,68 1 500 ICI/32,8	5,46 3 010 ICI/32,4	-	10,3 5 530 ICI/31,4	-	20,9 11 660 ICI/32,7	-	-	-	-	-	-	31,5	560		
31,5	-	0,44 235 CI/31,3	0,49 265 CI/31,3	0,87 480 CI/32,5	1,08 600 CI/32,5	2,11 1 080 CI/30,1	3,94 2 100 CI/31,3	-	7,62 4 000 CI/30,8	-	15,7 8 250 CI/30,8	-	31,4 17 000 CI/31,7	-	-	-	-	31,5	560			
200 000	200	-	-	-	-	1 060 ICI/192	2 360 ICI/199	-	4 550 ICI/196	-	9 280 ICI/196	-	-	-	-	-	-	-				

For n_1 lower than 560 min⁻¹ see page 195.

9 - Selection tables (bevel helical gear reducers)

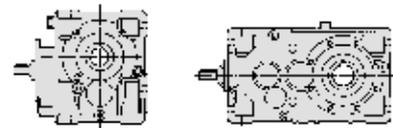

$n_{N2} \cdot L_h$ min ⁻¹ · h	i_N	P_{N2} kW																i_N	n_1	n_{N2} min ⁻¹		
		M_{N2} Nm																				
		... / i																				
		50	63	64	80	81	100	125	140	160	180	200	225	250	280	320	321	360				
200 000	160	-	-	-	-	-	-	-	6,49 3 730 C2I/151	9,95 5 850 C2I/154	14 8 490 C2I/158	20,4 11 800 C2I/151	28,5 17 010 C2I/156	40,7 24 300 C2I/156	55,6 32 650 C2I/154	- 42 570 C2I/156	- 50 080 C2I/156	- 69 000 C2I/161	160	2500	16	
	160	-	-	-	-	-	2,13 1 250 ICI/154	4,22 2 560 ICI/159	4,72 2 870 ICI/159	8,21 4 930 ICI/157	9,19 5 680 ICI/162	18,7 11 220 ICI/157	-	-	-	-	-	-	160	2500		
	125	-	-	-	-	-	-	-	7,08 4 150 C2I/123	11,4 7 020 C2I/129	14,9 9 210 C2I/130	22,9 13 890 C2I/127	29 17 350 C2I/125	47,4 27 870 C2I/123	59,2 35 460 C2I/125	78,3 48 240 C2I/129	97,9 60 310 C2I/129	112 67 660 C2I/127	125	2000		
	125	-	-	-	-	-	2,38 1 400 ICI/123	4,39 2 670 ICI/127	6,07 3 680 ICI/127	9,75 5 850 ICI/126	11,8 7 300 ICI/130	19,7 11 810 ICI/126	-	-	-	-	-	-	-	125		2000
	100	-	-	-	-	-	-	-	7,29 4 270 C2I/98,2	11,4 7 020 C2I/103	15,3 9 450 C2I/104	22,9 13 890 C2I/102	31,4 18 800 C2I/100	47,4 27 870 C2I/98,5	60,3 36 120 C2I/100	78,3 48 240 C2I/103	97,9 60 310 C2I/103	121 73 410 C2I/102	100	1600		
	100	-	0,42 250 ICI/99,4	0,5 295 ICI/99,4	0,83 510 ICI/103	0,97 600 ICI/103	2,2 1 320 ICI/100	4,89 2 970 ICI/102	6,25 3 740 ICI/100	9,61 6 050 ICI/106	13,9 8 500 ICI/102	19,4 12 240 ICI/106	-	-	-	-	-	-	-	100		1600
	90	-	-	-	-	-	-	-	7,17 4 300 C2I/87,8	12,6 7 750 C2I/90,4	13,7 8 380 C2I/90	25 15 020 C2I/87,9	30,9 19 050 C2I/90,3	47,7 28 980 C2I/89	58 35 500 C2I/89,7	76,4 46 280 C2I/88,8	95,5 57 850 C2I/88,8	114 71 000 C2I/91,4	90	1400		
	80	-	-	-	-	-	-	-	7,77 4 660 C2I/78,6	11,1 7 040 C2I/82,7	14,9 9 490 C2I/83,1	22,4 13 940 C2I/81,4	32,5 19 900 C2I/80,2	46,5 27 970 C2I/78,8	59,1 36 250 C2I/80,3	76,7 48 420 C2I/82,6	95,9 60 520 C2I/82,6	115 71 170 C2I/81,2	80	1250		
	80	0,27 155 ICI/75,2	0,45 270 ICI/79,5	0,55 335 ICI/79,5	0,92 580 ICI/82,7	1,06 670 ICI/82,7	2,14 1 250 ICI/76,7	4,29 2 560 ICI/78,1	5,03 3 000 ICI/78,1	8,88 5 300 ICI/78,1	9,76 6 000 ICI/80,5	18,8 11 220 ICI/78,1	-	-	-	-	-	-	-	80		1250
	71	-	-	-	-	-	-	-	7,33 4 390 C2I/70,2	12,6 7 750 C2I/72,3	13,7 8 380 C2I/72	25 15 020 C2I/70,3	32,2 19 820 C2I/72,2	47,7 28 980 C2I/71,2	58 35 500 C2I/71,7	76,4 46 280 C2I/71,1	95,5 57 850 C2I/71,1	114 71 000 C2I/73,1	71	1120		
	63	-	-	-	-	-	-	-	7,87 4 650 C2I/62	11,3 7 030 C2I/65,2	15,1 9 470 C2I/65,5	22,7 13 910 C2I/64,2	32,9 19 860 C2I/63,2	47,1 27 910 C2I/62,1	59,8 36 170 C2I/63,3	77,7 48 310 C2I/65,1	97,1 60 390 C2I/65,1	129 78 900 C2I/64	63	1000		
	63	0,27 155 ICI/60,1	0,45 270 ICI/63,6	0,55 335 ICI/63,6	0,92 580 ICI/66,2	1,06 670 ICI/66,2	2,39 1 400 ICI/61,3	4,46 2 660 ICI/62,5	6,17 3 680 ICI/62,5	9,81 5 850 ICI/62,5	12,2 7 500 ICI/64,4	19,8 11 810 ICI/62,5	-	-	-	-	-	-	-	63		1000
	56	-	-	-	-	-	-	-	7,59 4 460 C2I/55,4	12,8 7 740 C2I/57	13,9 8 370 C2I/56,8	25,4 14 970 C2I/55,5	33,4 20 200 C2I/56,9	48,5 28 900 C2I/56,1	67,4 40 460 C2I/56,6	77,6 46 150 C2I/56	97 57 690 C2I/56	134 82 030 C2I/57,6	56	900		
	50	-	-	-	-	-	-	-	7,75 4 670 C2I/50,4	11,3 7 030 C2I/52,1	15,1 9 470 C2I/52,4	21,8 14 010 C2I/53,9	31,6 20 000 C2I/53,1	45,2 28 110 C2I/52,1	57,4 36 440 C2I/53,1	78,7 48 200 C2I/51,3	98,4 60 250 C2I/51,3	131 78 720 C2I/50,5	50	800		
	50	0,29 170 ICI/49	0,49 300 ICI/50,9	0,58 350 ICI/50,9	1,01 640 ICI/53	1,13 715 ICI/53	2,21 1 320 ICI/49,9	4,97 2 970 ICI/50	6,35 3 740 ICI/49,3	9,82 6 150 ICI/52,5	14 8 490 ICI/50,8	19,9 12 440 ICI/52,5	-	-	-	-	-	-	-	50		800
	45	-	-	-	-	-	-	-	7,44 4 510 C2I/45,1	12,6 7 750 C2I/45,6	16,7 10 220 C2I/45,4	24,1 15 120 C2I/46,6	33,3 21 410 C2I/47,8	46 29 170 C2I/47,1	65,3 41 680 C2I/47,5	77,7 46 140 C2I/44,2	97,1 57 680 C2I/44,2	131 79 830 C2I/45,4	45	710		
40	-	-	-	-	-	-	-	7,25 4 250 C2I/38,7	12,9 7 750 C2I/39,5	14,9 9 250 C2I/41	24 15 500 C2I/42,6	31,9 20 000 C2I/41,4	47,7 31 000 C2I/42,8	64,5 40 600 C2I/41,6	88,5 53 010 C2I/39,5	111 66 260 C2I/39,5	120 74 700 C2I/41	40	630			
40	0,32 185 ICI/38,6	0,52 315 ICI/40,1	0,64 385 ICI/40,1	1,06 670 ICI/41,8	1,22 775 ICI/41,8	2,74 1 640 ICI/39,4	5,37 3 210 ICI/39,4	5,93 3 610 ICI/40,2	11,2 7 030 ICI/41,4	13,1 8 240 ICI/41,6	20,9 13 120 ICI/41,4	-	-	-	-	-	-	-	40	630		

For n_1 lower than 560 min⁻¹ see page 195.

9 - Selection tables (bevel helical gear reducers)

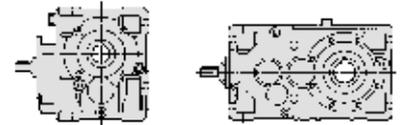

$n_{N2} \cdot L_h$ min ⁻¹ · h	i_N	P_{N2} kW																i_N	n_1 min ⁻¹	n_{N2} min ⁻¹	
		M_{N2} N m																			
		... / i																			
		50	63	64	80	81	100	125	140	160	180	200	225	250	280	320	321	360			
200 000	35,5	-	-	-	-	-	-	-	6,9 4 420 C21/37,5	12,1 7 750 C21/37,5	15,8 10 070 C21/37,3	25 15 030 C21/35,3	31,9 19 730 C21/36,2	45,9 29 180 C21/37,2	62,5 40 000 C21/37,5	75,1 46 430 C21/36,3	93,8 58 030 C21/36,3	122 77 500 C21/37,3	35,5	560	16
180 000	200	-	-	-	-	-	1,62 1 060 ICI/192	3,5 2 370 ICI/199	-	6,81 4 560 ICI/196	-	13,9 9 310 ICI/196	-	-	-	-	-	-	200	2800	14
	160	-	-	-	-	-	-	-	5,83 3 750 C21/151	8,95 5 870 C21/154	12,6 8 520 C21/158	18,3 11 840 C21/151	25,7 17 070 C21/156	36,6 24 380 C21/156	50 32 760 C21/154	64,1 42 720 C21/156	75,5 50 260 C21/156	101 69 000 C21/161	160	2240	
	160	-	-	-	-	-	1,92 1 260 ICI/154	3,79 2 570 ICI/159	4,25 2 880 ICI/159	7,42 4 970 ICI/157	8,31 5 730 ICI/162	16,8 11 260 ICI/157	-	-	-	-	-	-	160	2240	
	125	-	-	-	-	-	-	-	6,4 4 170 C21/123	10,4 7 130 C21/129	13,4 9 240 C21/130	20,9 14 110 C21/127	26,2 17 410 C21/125	43,4 28 320 C21/123	53,5 35 600 C21/125	71,6 49 020 C21/129	89,5 61 270 C21/129	104 69 830 C21/127	125	1800	
	125	-	-	-	-	-	2,15 1 400 ICI/123	3,97 2 680 ICI/127	5,48 3 700 ICI/127	8,8 5 870 ICI/126	10,7 7 320 ICI/130	17,8 11 850 ICI/126	-	-	-	-	-	-	125	1800	
	100	-	-	-	-	-	-	-	6,41 4 290 C21/98,2	10,2 7 160 C21/103	13,6 9 620 C21/104	20,4 14 170 C21/102	27,6 18 880 C21/100	42,3 28 440 C21/98,5	53,8 36 860 C21/100	69,9 49 230 C21/103	87,4 61 540 C21/103	110 76 410 C21/102	100	1400	
	100	-	0,37 250 ICI/99,4	0,44 295 ICI/99,4	0,73 515 ICI/103	0,85 600 ICI/103	1,94 1 330 ICI/100	4,29 2 980 ICI/102	5,49 3 750 ICI/100	8,54 6 150 ICI/106	12,2 8 530 ICI/102	17,3 12 440 ICI/106	-	-	-	-	-	-	100	1400	
	90	-	-	-	-	-	-	-	6,43 4 310 C21/87,8	11,2 7 750 C21/90,4	12,3 8 430 C21/90	22,7 15 280 C21/87,9	27,7 19 110 C21/90,3	43,4 29 490 C21/89	52,9 36 210 C21/89,7	69,4 47 080 C21/88,8	86,7 58 850 C21/88,8	102 71 150 C21/91,4	90	1250	
	80	-	-	-	-	-	-	-	7,08 4 740 C21/78,6	10,2 7 160 C21/82,7	13,6 9 620 C21/83,1	20,4 14 170 C21/81,4	29,6 20 230 C21/80,2	42,3 28 440 C21/78,8	53,8 36 860 C21/80,3	69,9 49 230 C21/82,6	87,4 61 540 C21/82,6	106 73 560 C21/81,2	80	1120	
	80	0,24 155 ICI/75,2	0,4 270 ICI/79,5	0,49 335 ICI/79,5	0,82 580 ICI/82,7	0,95 670 ICI/82,7	1,92 1 260 ICI/76,7	3,86 2 570 ICI/78,1	4,5 3 000 ICI/78,1	7,96 5 300 ICI/78,1	8,74 6 000 ICI/80,5	16,9 11 260 ICI/78,1	-	-	-	-	-	-	80	1120	
	71	-	-	-	-	-	-	-	6,68 4 480 C21/70,2	11,2 7 750 C21/72,3	12,3 8 430 C21/72	22,7 15 280 C21/70,3	29,4 20 280 C21/72,2	43,4 29 490 C21/71,2	51,8 35 500 C21/71,7	69,4 47 080 C21/71,1	86,7 58 850 C21/71,1	102 71 000 C21/73,1	71	1000	
	63	-	-	-	-	-	-	-	7,19 4 730 C21/62	10,3 7 140 C21/65,2	13,8 9 610 C21/65,5	20,8 14 130 C21/64,2	30,1 20 180 C21/63,2	43 28 360 C21/62,1	54,7 36 750 C21/63,3	71 49 090 C21/65,1	88,8 61 360 C21/65,1	118 80 170 C21/64	63	900	
	63	0,25 155 ICI/60,1	0,4 270 ICI/63,6	0,5 335 ICI/63,6	0,83 580 ICI/66,2	0,95 670 ICI/66,2	2,16 1 400 ICI/61,3	4,03 2 670 ICI/62,5	5,57 3 690 ICI/62,5	8,85 5 870 ICI/62,5	11 7 500 ICI/64,4	17,9 11 850 ICI/62,5	-	-	-	-	-	-	63	900	
	56	-	-	-	-	-	-	-	6,78 4 480 C21/55,4	11,4 7 750 C21/57	12,4 8 430 C21/56,8	23 15 240 C21/55,5	29,8 20 270 C21/56,9	43,9 29 420 C21/56,1	60,1 40 610 C21/56,6	70,2 46 980 C21/56	87,8 58 730 C21/56	120 82 710 C21/57,6	56	800	
	50	-	-	-	-	-	-	-	7 4 750 C21/50,4	10,2 7 150 C21/52,1	13,7 9 640 C21/52,4	19,7 14 270 C21/53,9	28,5 20 370 C21/53,1	40,8 28 620 C21/52,1	51,9 37 100 C21/53,1	71,1 49 080 C21/51,3	88,9 61 350 C21/51,3	118 80 160 C21/50,5	50	710	
	50	0,26 170 ICI/49	0,44 300 ICI/50,9	0,52 355 ICI/50,9	0,9 640 ICI/53	1,01 720 ICI/53	1,97 1 320 ICI/49,9	4,43 2 980 ICI/50	5,66 3 750 ICI/49,3	8,71 6 150 ICI/52,5	12,5 8 530 ICI/50,8	17,6 12 440 ICI/52,5	-	-	-	-	-	-	50	710	
45	-	-	-	-	-	-	-	6,84 4 670 C21/45,1	11,2 7 750 C21/45,6	14,9 10 260 C21/45,4	21,8 15 390 C21/46,6	30,1 21 800 C21/47,8	41,6 29 710 C21/47,1	59 42 440 C21/47,5	70,2 46 980 C21/44,2	87,7 58 730 C21/44,2	120 82 740 C21/45,4	45	630		

For n_1 lower than 560 min⁻¹ see page 195.

9 - Selection tables (bevel helical gear reducers)

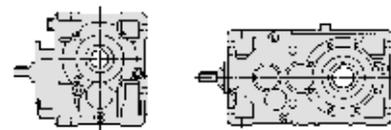

$n_{N2} \cdot L_h$ min ⁻¹ · h	i_N	P_{N2} kW																i_N	n_1	n_{N2} min ⁻¹	
		M_{N2} N m																			
		... / i																			
		50	63	64	80	81	100	125	140	160	180	200	225	250	280	320	321	360			
180 000	40	-	-	-	-	-	-	-	6,45 4 250 C21/38,7	11,5 7 750 C21/39,5	13,2 9 250 C21/41	21,3 15 500 C21/42,6	28,3 20 000 C21/41,4	43,1 31 500 C21/42,8	57,5 40 750 C21/41,6	80 53 960 C21/39,5	100 67 450 C21/39,5	111 77 380 C21/41	40	560	14
	40	0,29 190 ICI/38,6	0,46 315 ICI/40,1	0,57 390 ICI/40,1	0,94 670 ICI/41,8	1,1 785 ICI/41,8	2,48 1 670 ICI/39,4	4,86 3 270 ICI/39,4	5,46 3 740 ICI/40,2	10,1 7 160 ICI/41,4	11,6 8 250 ICI/41,6	18,7 13 170 ICI/41,4	-	-	-	-	-	-	-	40	560
160 000	200	-	-	-	-	-	1,49 1 090 ICI/192	3,14 2 380 ICI/199	-	6,1 4 580 ICI/196	-	12,5 9 350 ICI/196	-	-	-	-	-	-	200	2500	12,5
	160	-	-	-	-	-	-	-	5,23 3 760 C21/151	8,06 5 920 C21/154	11,4 8 600 C21/158	16,5 11 920 C21/151	23,1 17 180 C21/156	32,9 24 550 C21/156	44,9 32 980 C21/154	57,9 43 160 C21/156	68,1 50 770 C21/156	92,4 71 000 C21/161	160	2000	
	160	-	-	-	-	-	1,72 1 260 ICI/154	3,4 2 580 ICI/159	3,81 2 890 ICI/159	6,72 5 040 ICI/157	7,52 5 810 ICI/162	15,1 11 300 ICI/157	-	-	-	-	-	-	160	2000	
	125	-	-	-	-	-	-	-	5,71 4 180 C21/123	9,41 7 260 C21/129	12 9 270 C21/130	18,9 14 370 C21/127	23,4 17 480 C21/125	39,2 28 830 C21/123	47,7 35 730 C21/125	64,8 49 900 C21/129	81 62 380 C21/129	95,5 72 350 C21/127	125	1600	
	125	-	-	-	-	-	1,93 1 420 ICI/123	3,56 2 700 ICI/127	4,89 3 710 ICI/127	7,91 5 940 ICI/126	9,55 7 380 ICI/130	16 11 990 ICI/126	-	-	-	-	-	-	125	1600	
	100	-	-	-	-	-	-	-	5,74 4 310 C21/98,2	9,22 7 280 C21/103	12,2 9 650 C21/104	18,6 14 420 C21/102	24,7 18 950 C21/100	38,5 28 930 C21/98,5	48,9 37 500 C21/100	63,5 50 080 C21/103	79,4 62 600 C21/103	101 78 640 C21/102	100	1250	
	100	-	0,33 250 ICI/99,4	0,39 300 ICI/99,4	0,65 515 ICI/103	0,77 605 ICI/103	1,74 1 330 ICI/100	3,85 2 990 ICI/102	4,96 3 800 ICI/100	7,63 6 150 ICI/106	11,1 8 630 ICI/102	15,4 12 440 ICI/106	-	-	-	-	-	-	100	1250	
	90	-	-	-	-	-	-	-	5,78 4 330 C21/87,8	10,1 7 750 C21/90,4	11 8 480 C21/90	20,7 15 500 C21/87,9	24,9 19 180 C21/90,3	39,5 29 980 C21/89	48,9 37 420 C21/89,7	63,2 47 870 C21/88,8	79 59 840 C21/88,8	94,4 73 530 C21/91,4	90	1120	
	80	-	-	-	-	-	-	-	6,43 4 820 C21/78,6	9,22 7 280 C21/82,7	12,2 9 650 C21/83,1	18,6 14 420 C21/81,4	26,9 20 580 C21/80,2	38,5 28 930 C21/78,8	48,9 37 500 C21/80,3	63,5 50 080 C21/82,6	79,4 62 600 C21/82,6	98,1 76 100 C21/81,2	80	1000	
	80	0,22 160 ICI/75,2	0,36 270 ICI/79,5	0,44 335 ICI/79,5	0,73 580 ICI/82,7	0,85 670 ICI/82,7	1,72 1 260 ICI/76,7	3,46 2 580 ICI/78,1	4,02 3 000 ICI/78,1	7,1 5 300 ICI/78,1	7,81 6 000 ICI/80,5	15,1 11 300 ICI/78,1	-	-	-	-	-	-	80	1000	
	71	-	-	-	-	-	-	-	6,03 4 490 C21/70,2	10,1 7 750 C21/72,3	11,1 8 480 C21/72	20,8 15 500 C21/70,3	26,6 20 350 C21/72,2	39,7 29 960 C21/71,2	47,4 36 090 C21/71,7	63,4 47 840 C21/71,1	79,3 59 800 C21/71,1	91,5 71 000 C21/73,1	71	900	
	63	-	-	-	-	-	-	-	6,51 4 810 C21/62	9,34 7 270 C21/65,2	12,3 9 650 C21/65,5	18,8 14 390 C21/64,2	27,2 20 540 C21/63,2	38,9 28 870 C21/62,1	49,5 37 410 C21/63,3	64,3 49 970 C21/65,1	80,4 62 460 C21/65,1	107 81 610 C21/64	63	800	
	63	0,22 160 ICI/60,1	0,36 270 ICI/63,6	0,44 335 ICI/63,6	0,73 580 ICI/66,2	0,85 670 ICI/66,2	1,94 1 420 ICI/61,3	3,61 2 700 ICI/62,5	4,97 3 710 ICI/62,5	7,95 5 930 ICI/62,5	9,76 7 500 ICI/64,4	16,1 11 980 ICI/62,5	-	-	-	-	-	-	63	800	
	56	-	-	-	-	-	-	-	6,04 4 490 C21/55,4	10,1 7 750 C21/57	11,1 8 480 C21/56,8	20,8 15 500 C21/55,5	26,6 20 350 C21/56,9	39,7 29 960 C21/56,1	53,6 40 760 C21/56,6	63,5 47 840 C21/56	79,3 59 800 C21/56	107 83 030 C21/57,6	56	710	
	50	-	-	-	-	-	-	-	6,33 4 840 C21/50,4	9,22 7 280 C21/52,1	12,4 9 820 C21/52,4	17,8 14 530 C21/53,9	25,8 20 740 C21/53,1	36,9 29 150 C21/52,1	46,9 37 780 C21/53,1	64,3 49 970 C21/51,3	80,3 62 470 C21/51,3	107 81 620 C21/50,5	50	630	
	50	0,23 170 ICI/49	0,39 300 ICI/50,9	0,46 355 ICI/50,9	0,8 645 ICI/53	0,9 720 ICI/53	1,74 1 320 ICI/49,9	3,94 2 990 ICI/50	5,06 3 780 ICI/49,3	7,73 6 150 ICI/52,5	11,2 8 620 ICI/50,8	15,6 12 440 ICI/52,5	-	-	-	-	-	-	50	630	

For n_1 lower than 560 min⁻¹ see page 195.

9 - Selection tables (bevel helical gear reducers)

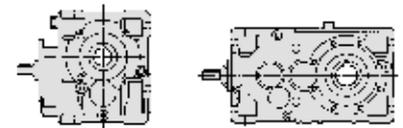

$n_{N2} \cdot L_h$ min ⁻¹ · h	i_N	P_{N2} kW																i_N	n_1	n_{N2} min ⁻¹	
		M_{N2} N m																			
		... / i																			
		50	63	64	80	81	100	125	140	160	180	200	225	250	280	320	321	360			
160 000	45	-	-	-	-	-	-	-	6,3 4 840 C2I/45,1	9,96 7 750 C2I/45,6	13,3 10 300 C2I/45,4	19,5 15 500 C2I/46,6	26,7 21 800 C2I/47,8	37,6 30 240 C2I/47,1	53,3 43 200 C2I/47,5	63,5 47 830 C2I/44,2	79,4 59 790 C2I/44,2	111 85 720 C2I/45,4	45	560	12,5
140 000	200	-	-	-	-	-	1,34 1 100 ICI/192	2,82 2 390 ICI/199	-	5,49 4 590 ICI/196	-	11,2 9 380 ICI/196	-	-	-	-	-	-	200	2240	11,2
	160	-	-	-	-	-	-	-	4,78 3 820 C2I/151	7,37 6 010 C2I/154	10,4 8 730 C2I/158	15,1 12 110 C2I/151	21,1 17 460 C2I/156	30,1 24 940 C2I/156	41,1 33 510 C2I/154	52,9 43 850 C2I/156	62,2 51 590 C2I/156	83,2 71 000 C2I/161	160	1800	
	160	-	-	-	-	-	1,55 1 270 ICI/154	3,07 2 590 ICI/159	3,47 2 920 ICI/159	6,12 5 100 ICI/157	6,85 5 880 ICI/162	13,6 11 340 ICI/157	-	-	-	-	-	-	160	1800	
	125	-	-	-	-	-	-	-	5,01 4 200 C2I/123	8,4 7 400 C2I/129	10,5 9 310 C2I/130	16,9 14 660 C2I/127	20,5 17 550 C2I/125	35 29 410 C2I/123	41,9 35 880 C2I/125	57,8 50 920 C2I/129	72,3 63 650 C2I/129	84,1 72 830 C2I/127	125	1400	
	125	-	-	-	-	-	1,73 1 450 ICI/123	3,18 2 760 ICI/127	4,29 3 720 ICI/127	7,07 6 060 ICI/126	8,49 7 500 ICI/130	14,3 12 230 ICI/126	-	-	-	-	-	-	125	1400	
	100	-	-	-	-	-	-	-	5,16 4 320 C2I/98,2	8,4 7 400 C2I/103	10,9 9 690 C2I/104	16,9 14 660 C2I/102	22,3 19 020 C2I/100	35 29 410 C2I/98,5	44,6 38 120 C2I/100	57,8 50 920 C2I/103	72,3 63 650 C2I/103	91,1 78 910 C2I/102	100	1120	
	100	-	0,3 255 ICI/99,4	0,35 300 ICI/99,4	0,59 515 ICI/103	0,69 605 ICI/103	1,56 1 330 ICI/100	3,46 3 000 ICI/102	4,52 3 860 ICI/100	6,83 6 150 ICI/106	9,76 8 500 ICI/102	13,8 12 440 ICI/106	-	-	-	-	-	-	100	1120	
	90	-	-	-	-	-	-	-	5,18 4 340 C2I/87,8	8,98 7 750 C2I/90,4	9,89 8 500 C2I/90	18,5 15 500 C2I/87,9	22,3 19 250 C2I/90,3	35,9 30 500 C2I/89	45,2 38 710 C2I/89,7	57,4 48 700 C2I/88,8	71,7 60 870 C2I/88,8	87,2 76 070 C2I/91,4	90	1000	
	80	-	-	-	-	-	-	-	5,88 4 900 C2I/78,6	8,44 7 400 C2I/82,7	11 9 680 C2I/83,1	17 14 650 C2I/81,4	24,6 20 910 C2I/80,2	35,2 29 390 C2I/78,8	44,7 38 100 C2I/80,3	58,1 50 880 C2I/82,6	72,6 63 600 C2I/82,6	91,1 78 550 C2I/81,2	80	900	
	80	0,2 160 ICI/75,2	0,32 270 ICI/79,5	0,4 335 ICI/79,5	0,66 580 ICI/82,7	0,76 670 ICI/82,7	1,56 1 270 ICI/76,7	3,12 2 590 ICI/78,1	3,62 3 000 ICI/78,1	6,39 5 300 ICI/78,1	7,03 6 000 ICI/80,5	13,7 11 330 ICI/78,1	-	-	-	-	-	-	80	900	
	71	-	-	-	-	-	-	-	5,38 4 510 C2I/70,2	8,98 7 750 C2I/72,3	9,89 8 500 C2I/72	18,5 15 500 C2I/70,3	23,7 20 420 C2I/72,2	35,9 30 500 C2I/71,2	43,7 37 390 C2I/71,7	57,4 48 700 C2I/71,1	71,7 60 870 C2I/71,1	83,9 73 230 C2I/73,1	71	800	
	63	-	-	-	-	-	-	-	5,88 4 900 C2I/62	8,44 7 400 C2I/65,2	11 9 680 C2I/65,5	17 14 650 C2I/64,2	24,6 20 910 C2I/63,2	35,2 29 390 C2I/62,1	44,7 38 100 C2I/63,3	58,1 50 880 C2I/65,1	72,6 63 600 C2I/65,1	96,5 83 100 C2I/64	63	710	
	63	0,2 160 ICI/60,1	0,32 270 ICI/63,6	0,39 335 ICI/63,6	0,65 580 ICI/66,2	0,75 670 ICI/66,2	1,75 1 440 ICI/61,3	3,27 2 750 ICI/62,5	4,43 3 720 ICI/62,5	7,19 6 040 ICI/62,5	8,66 7 500 ICI/64,4	14,5 12 190 ICI/62,5	-	-	-	-	-	-	63	710	
	56	-	-	-	-	-	-	-	5,36 4 500 C2I/55,4	8,97 7 750 C2I/57	9,88 8 500 C2I/56,8	18,4 15 500 C2I/55,5	23,7 20 420 C2I/56,9	35,8 30 500 C2I/56,1	47,7 40 910 C2I/56,6	57,3 48 710 C2I/56	71,7 60 890 C2I/56	95,4 83 340 C2I/57,6	56	630	
	50	-	-	-	-	-	-	-	5,73 4 930 C2I/50,4	8,34 7 410 C2I/52,1	11,2 9 990 C2I/52,4	16,1 14 790 C2I/53,9	23,3 21 110 C2I/53,1	33,4 29 670 C2I/52,1	42,4 38 460 C2I/53,1	58,1 50 870 C2I/51,3	72,7 63 590 C2I/51,3	96,6 83 090 C2I/50,5	50	560	
50	0,2 170 ICI/49	0,35 305 ICI/50,9	0,41 355 ICI/50,9	0,72 645 ICI/53	0,8 725 ICI/53	1,55 1 320 ICI/49,9	3,52 3 000 ICI/50	4,58 3 850 ICI/49,3	6,87 6 150 ICI/52,5	10,1 8 770 ICI/50,8	13,9 12 440 ICI/52,5	-	-	-	-	-	-	50	560		
125 000	200	-	-	-	-	1,2 1 100 ICI/192	2,53 2 400 ICI/199	-	4,92 4 610 ICI/196	-	10 9 410 ICI/196	-	-	-	-	-	-	-	200	2000	10

For n_1 lower than 560 min⁻¹ see page 195.

9 - Selection tables (bevel helical gear reducers)

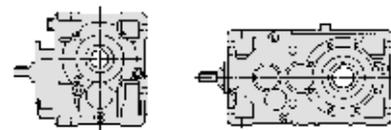

$n_{N2} \cdot L_h$ min ⁻¹ · h	i_N	P_{N2} kW																i_N	n_1	n_{N2} min ⁻¹			
		M_{N2} N m																					
		... / i																					
		50	63	64	80	81	100	125	140	160	180	200	225	250	280	320	321	360					
125 000	160	-	-	-	-	-	-	-	4,33 3 890 C2I/151	6,67 6 120 C2I/154	9,4 8 890 C2I/158	13,6 12 330 C2I/151	19,1 17 770 C2I/156	27,2 25 390 C2I/156	37,2 34 110 C2I/154	47,9 44 640 C2I/156	56,3 52 520 C2I/156	76 73 000 C2I/161	160	1600	10		
	160	-	-	-	-	-	1,38 1 270 ICI/154	2,74 2 600 ICI/159	3,13 2 970 ICI/159	5,52 5 180 ICI/157	6,18 5 970 ICI/162	12,1 11 380 ICI/157	-	-	-	-	-	-	160	1600			
	125	-	-	-	-	-	-	-	4,49 4 210 C2I/123	7,6 7 500 C2I/129	9,42 9 340 C2I/130	15,4 14 920 C2I/127	18,4 17 610 C2I/125	31,8 29 920 C2I/123	37,6 36 010 C2I/125	52,5 51 800 C2I/129	65,7 64 750 C2I/129	75,4 73 090 C2I/127	125	1250			
	125	-	-	-	-	-	1,55 1 460 ICI/123	2,89 2 810 ICI/127	3,85 3 740 ICI/127	6,42 6 160 ICI/126	7,58 7 500 ICI/130	13 12 440 ICI/126	-	-	-	-	-	-	-	125		1250	
	100	-	-	-	-	-	-	-	4,62 4 340 C2I/98,2	7,6 7 500 C2I/103	9,8 9 720 C2I/104	15,4 14 920 C2I/102	19,9 19 080 C2I/100	31,8 29 920 C2I/98,5	40,5 38 780 C2I/100	52,5 51 800 C2I/103	65,7 64 750 C2I/103	81,7 79 190 C2I/102	100	1000			
	100	-	0,27 255 ICI/99,4	0,32 300 ICI/99,4	0,53 520 ICI/103	0,62 610 ICI/103	1,4 1 340 ICI/100	3,1 3 010 ICI/102	4,1 3 930 ICI/100	6,1 6 150 ICI/106	8,72 8 500 ICI/102	12,3 12 440 ICI/106	-	-	-	-	-	-	-	100		1000	
	90	-	-	-	-	-	-	-	4,68 4 360 C2I/87,8	8,08 7 750 C2I/90,4	8,9 8 500 C2I/90	16,6 15 500 C2I/87,9	20,2 19 310 C2I/90,3	32,8 30 990 C2I/89	41 39 020 C2I/89,7	52,5 49 480 C2I/88,8	65,6 61 850 C2I/88,8	81 78 510 C2I/91,4	90	900			
	80	-	-	-	-	-	-	-	5,32 4 990 C2I/78,6	7,6 7 500 C2I/82,7	9,8 9 720 C2I/83,1	15,4 14 920 C2I/81,4	22,2 21 200 C2I/80,2	31,8 29 920 C2I/78,8	40,5 38 780 C2I/80,3	52,5 51 800 C2I/82,6	65,7 64 750 C2I/82,6	83,9 81 370 C2I/81,2	80	800			
	80	0,18 160 ICI/75,2	0,29 270 ICI/79,5	0,35 335 ICI/79,5	0,59 580 ICI/82,7	0,69 675 ICI/82,7	1,39 1 270 ICI/76,7	2,78 2 600 ICI/78,1	3,22 3 000 ICI/78,1	5,68 5 300 ICI/78,1	6,25 6 000 ICI/80,5	12,2 11 380 ICI/78,1	-	-	-	-	-	-	-	80		800	
	71	-	-	-	-	-	-	-	4,79 4 530 C2I/70,2	7,97 7 750 C2I/72,3	8,78 8 500 C2I/72	16,4 15 500 C2I/70,3	21,1 20 500 C2I/72,2	32,4 31 050 C2I/71,2	40,2 38 750 C2I/71,7	51,9 49 590 C2I/71,1	64,8 61 980 C2I/71,1	77,2 75 900 C2I/73,1	71	710			
	63	-	-	-	-	-	-	-	5,31 4 990 C2I/62	7,59 7 500 C2I/65,2	9,79 9 720 C2I/65,5	15,3 14 920 C2I/64,2	22,1 21 200 C2I/63,2	31,8 29 930 C2I/62,1	40,4 38 790 C2I/63,3	52,5 51 810 C2I/65,1	65,6 64 760 C2I/65,1	87,2 84 620 C2I/64	63	630			
	63	0,18 165 ICI/60,1	0,28 270 ICI/63,6	0,35 335 ICI/63,6	0,58 580 ICI/66,2	0,68 680 ICI/66,2	1,56 1 450 ICI/61,3	2,95 2 800 ICI/62,5	3,94 3 740 ICI/62,5	6,49 6 150 ICI/62,5	7,68 7 500 ICI/64,4	13,1 12 420 ICI/62,5	-	-	-	-	-	-	-	63		630	
	56	-	-	-	-	-	-	-	4,77 4 500 C2I/55,4	7,97 7 750 C2I/57	8,78 8 500 C2I/56,8	16,4 15 500 C2I/55,5	21,1 20 500 C2I/56,9	32,4 31 050 C2I/56,1	42,6 41 070 C2I/56,6	51,9 49 580 C2I/56	64,9 61 980 C2I/56	85,1 83 650 C2I/57,6	56	560			
	112 000	200	-	-	-	-	1,08 1 110 ICI/192	2,28 2 410 ICI/199	-	4,44 4 630 ICI/196	-	9,06 9 450 ICI/196	-	-	-	-	-	-	-	200		1800	9
		160	-	-	-	-	-	-	3,86 3 970 C2I/151	5,95 6 250 C2I/154	8,39 9 070 C2I/158	12,2 12 580 C2I/151	17 18 130 C2I/156	24,3 25 910 C2I/156	33,2 34 810 C2I/154	42,7 45 550 C2I/156	50,3 53 590 C2I/156	66,5 73 000 C2I/161	160	1400			
160		-	-	-	-	1,22 1 280 ICI/154	2,41 2 610 ICI/159	2,77 3 000 ICI/159	4,91 5 260 ICI/157	5,43 6 000 ICI/162	10,7 11 430 ICI/157	-	-	-	-	-	-	-	160	1400			
125		-	-	-	-	-	-	4,04 4 230 C2I/123	6,81 7 500 C2I/129	8,47 9 380 C2I/130	14 15 160 C2I/127	16,5 17 670 C2I/125	29 30 420 C2I/123	33,8 36 130 C2I/125	47,9 52 670 C2I/129	59,1 65 000 C2I/129	67,8 73 340 C2I/127	125	1120				
125		-	-	-	-	1,39 1 460 ICI/123	2,63 2 850 ICI/127	3,46 3 750 ICI/127	5,85 6 270 ICI/126	6,79 7 500 ICI/130	11,8 12 650 ICI/126	-	-	-	-	-	-	-	125	1120			

For n_1 lower than 560 min⁻¹ see page 195.

9 - Selection tables (bevel helical gear reducers)

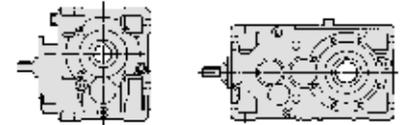

$n_{N2} \cdot L_h$ min ⁻¹ · h	i_N	P_{N2} kW																i_N	n_1	n_{N2} min ⁻¹	
		50	63	64	80	81	100	125	140	160	180	200	225	250	280	320	321				360
112 000	100	-	-	-	-	-	-	4,18 4 350	6,84 7 500	8,85 9 750	14 15 150	18 19 150	29,1 30 400	36,6 38 990	48 52 630	59,3 65 000	73,7 79 460	100	900	9	
	100	-	0,24 255 ICI/99,4	0,28 300 ICI/99,4	0,47 520 ICI/103	0,56 610 ICI/103	1,26 1 340 ICI/100	2,8 3 020 ICI/102	3,75 3 990 ICI/100	5,49 6 150 ICI/106	8,07 8 750 ICI/102	11,1 12 440 ICI/106	-	-	-	-	-	100	900		
	90	-	-	-	-	-	-	4,17 4 370	7,18 7 750	7,91 8 500	14,8 15 500	18 19 380	29,7 31 500	36,6 39 160	47,5 50 370	59,4 62 960	73,7 80 390	90	800		
	80	-	-	-	-	-	-	4,73 5 000	6,75 7 500	8,73 9 750	13,9 15 190	19,7 21 200	28,8 30 470	36,6 39 490	47,5 52 740	58,5 65 000	77,2 84 340	80	710		
	80	0,16 165 ICI/75,2	0,25 270 ICI/79,5	0,31 335 ICI/79,5	0,53 585 ICI/82,7	0,62 690 ICI/82,7	1,24 1 270 ICI/76,7	2,48 2 610 ICI/78,1	2,85 3 000 ICI/78,1	5,04 5 300 ICI/78,1	5,54 6 000 ICI/80,5	10,9 11 420 ICI/78,1	-	-	-	-	-	80	710		
	71	-	-	-	-	-	-	4,27 4 540	7,07 7 750	7,79 8 500	14,5 15 500	18,8 20 580	29,2 31 500	36,9 40 170	46,9 50 490	58,6 63 110	71 78 670	71	630		
	63	-	-	-	-	-	-	4,73 5 000	6,75 7 500	8,73 9 750	13,9 15 190	19,7 21 200	28,8 30 470	36,6 39 490	47,5 52 740	58,5 65 000	77,8 85 000	63	560		
	63	0,16 165 ICI/60,1	0,25 270 ICI/63,6	0,31 335 ICI/63,6	0,52 590 ICI/66,2	0,61 690 ICI/66,2	1,39 1 450 ICI/61,3	2,67 2 850 ICI/62,5	3,52 3 750 ICI/62,5	5,88 6 260 ICI/62,5	6,83 7 500 ICI/64,4	11,9 12 640 ICI/62,5	-	-	-	-	-	63	560		
	100 000	200	-	-	-	-	0,97 1 110 ICI/192	2,04 2 410 ICI/199	-	3,96 4 640 ICI/196	-	8,09 9 480 ICI/196	-	-	-	-	-	-	200	1600	8
		160	-	-	-	-	-	-	3,51 4 040 ICI/151	5,41 6 360 ICI/154	7,62 9 230 ICI/158	11,1 12 800 ICI/151	15,5 18 450 ICI/156	22,1 26 350 ICI/156	30,1 35 410 ICI/154	38,7 46 200 ICI/156	45,7 54 500 ICI/156	59,4 73 000 ICI/161	160	1250	
160		-	-	-	-	1,09 1 280 ICI/154	2,16 2 620 ICI/159	2,47 3 000 ICI/159	4,38 5 260 ICI/157	4,85 6 000 ICI/162	9,55 11 470 ICI/157	-	-	-	-	-	-	160	1250		
125		-	-	-	-	-	-	3,62 4 240 ICI/123	6,08 7 500 ICI/129	7,59 9 410 ICI/130	12,7 15 430 ICI/127	14,8 17 740 ICI/125	26,1 30 700 ICI/123	30,3 36 260 ICI/125	43 53 000 ICI/129	52,7 65 000 ICI/129	60,7 73 610 ICI/127	125	1000		
125		-	-	-	-	1,25 1 470 ICI/123	2,39 2 900 ICI/127	3,1 3 760 ICI/127	5,31 6 380 ICI/126	6,06 7 500 ICI/130	10,6 12 710 ICI/126	-	-	-	-	-	-	125	1000		
100		-	-	-	-	-	-	3,73 4 370 ICI/98,2	6,08 7 500 ICI/103	7,9 9 790 ICI/104	12,7 15 430 ICI/102	16,1 19 220 ICI/100	26,1 30 700 ICI/98,5	32,7 39 130 ICI/100	43 53 000 ICI/103	52,7 65 000 ICI/103	65,8 79 750 ICI/102	100	800		
100		-	0,22 255 ICI/99,4	0,25 300 ICI/99,4	0,42 520 ICI/103	0,5 615 ICI/103	1,13 1 350 ICI/100	2,5 3 030 ICI/102	3,39 4 060 ICI/100	4,88 6 150 ICI/106	7,18 8 750 ICI/102	9,87 12 440 ICI/106	-	-	-	-	-	100	800		
90		-	-	-	-	-	-	3,72 4 390 ICI/87,8	6,37 7 750 ICI/90,4	7,02 8 500 ICI/90	13,1 15 500 ICI/87,9	16 19 460 ICI/90,3	26,3 31 500 ICI/89	32,6 39 310 ICI/89,7	42,9 51 290 ICI/88,8	53,6 64 110 ICI/88,8	65,6 80 690 ICI/91,4	90	710		
80		-	-	-	-	-	-	4,2 5 000 ICI/78,6	5,99 7 500 ICI/82,7	7,74 9 750 ICI/83,1	12,5 15 460 ICI/81,4	17,4 21 200 ICI/80,2	25,7 30 700 ICI/78,8	33 40 210 ICI/80,3	42,3 53 000 ICI/82,6	51,9 65 000 ICI/82,6	69 85 000 ICI/81,2	80	630		
80		0,14 165 ICI/75,2	0,23 270 ICI/79,5	0,28 335 ICI/79,5	0,48 595 ICI/82,7	0,56 700 ICI/82,7	1,1 1 280 ICI/76,7	2,21 2 620 ICI/78,1	2,53 3 000 ICI/78,1	4,48 5 300 ICI/78,1	4,92 6 000 ICI/80,5	9,68 11 460 ICI/78,1	-	-	-	-	-	80	630		

For n_1 lower than 560 min⁻¹ see page 195.

9 - Selection tables (bevel helical gear reducers)

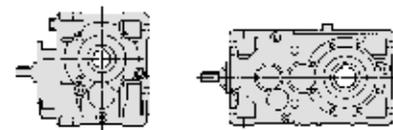

$n_{N2} \cdot L_h$ min ⁻¹ · h	i_N	P_{N2} kW																i_N	n_1	n_{N2}	
		M_{N2} N m																			
		... / i																			
		50	63	64	80	81	100	125	140	160	180	200	225	250	280	320	321	360			
100 000	71	-	-	-	-	-	-	-	3,81 4 560 C2I/70,2	6,28 7 750 C2I/72,3	6,92 8 500 C2I/72	12,9 15 500 C2I/70,3	16,7 20 600 C2I/72,2	25,9 31 500 C2I/71,2	33,7 41 200 C2I/71,7	42,4 51 400 C2I/71,1	53 64 250 C2I/71,1	65,4 81 500 C2I/73,1	71	560	8
90 000	200	-	-	-	-	-	0,85 1 110 ICI/192	1,79 2 420 ICI/199	-	3,48 4 660 ICI/196	-	7,1 9 520 ICI/196	-	-	-	-	-	-	200	1400	7,1
	160	-	-	-	-	-	-	-	3,2 4 110 C2I/151	4,93 6 460 C2I/154	6,85 9 250 C2I/158	10,1 13 010 C2I/151	13,9 18 500 C2I/156	19,9 26 500 C2I/156	27,4 36 000 C2I/154	34,7 46 200 C2I/156	40,9 54 500 C2I/156	53,2 73 000 C2I/161	160	1120	
	160	-	-	-	-	-	0,98 1 280 ICI/154	1,94 2 630 ICI/159	2,21 3 000 ICI/159	3,92 5 260 ICI/157	4,35 6 000 ICI/162	8,59 11 510 ICI/157	-	-	-	-	-	-	160	1120	
	125	-	-	-	-	-	-	-	3,27 4 260 C2I/123	5,47 7 500 C2I/129	6,85 9 440 C2I/130	11,5 15 500 C2I/127	13,4 17 800 C2I/125	23,5 30 700 C2I/123	27,3 36 380 C2I/125	38,7 53 000 C2I/129	47,5 65 000 C2I/129	54,8 73 850 C2I/127	125	900	
	125	-	-	-	-	-	1,13 1 470 ICI/123	2,19 2 950 ICI/127	2,8 3 780 ICI/127	4,86 6 480 ICI/126	5,46 7 500 ICI/130	9,56 12 750 ICI/126	-	-	-	-	-	-	125	900	
	100	-	-	-	-	-	-	-	3,31 4 370 C2I/98,2	5,4 7 500 C2I/103	7,03 9 830 C2I/104	11,3 15 500 C2I/102	14,3 19 290 C2I/100	23,2 30 700 C2I/98,5	29,1 39 280 C2I/100	38,2 53 000 C2I/103	46,8 65 000 C2I/103	58,6 80 000 C2I/102	100	710	
	100	-	0,19 255 ICI/99,4	0,23 305 ICI/99,4	0,38 525 ICI/103	0,44 615 ICI/103	1 1 350 ICI/100	2,22 3 040 ICI/102	3,07 4 140 ICI/100	4,33 6 150 ICI/106	6,37 8 750 ICI/102	8,76 12 440 ICI/106	-	-	-	-	-	-	100	710	
	90	-	-	-	-	-	-	-	3,31 4 400 C2I/87,8	5,66 7 750 C2I/90,4	6,23 8 500 C2I/90	11,6 15 500 C2I/87,9	14,3 19 500 C2I/90,3	23,3 31 500 C2I/89	29 39 460 C2I/89,7	38,8 52 230 C2I/88,8	48,5 65 280 C2I/88,8	58,5 81 000 C2I/91,4	90	630	
	80	-	-	-	-	-	-	-	3,73 5 000 C2I/78,6	5,32 7 500 C2I/82,7	6,88 9 750 C2I/83,1	11,2 15 500 C2I/81,4	15,5 21 200 C2I/80,2	22,9 30 700 C2I/78,8	29,9 40 930 C2I/80,3	37,6 53 000 C2I/82,6	46,2 65 000 C2I/82,6	61,4 85 000 C2I/81,2	80	560	
	80	0,13 165 ICI/75,2	0,2 275 ICI/79,5	0,25 345 ICI/79,5	0,43 610 ICI/82,7	0,5 710 ICI/82,7	0,98 1 280 ICI/76,7	1,97 2 630 ICI/78,1	2,25 3 000 ICI/78,1	3,98 5 300 ICI/78,1	4,37 6 000 ICI/80,5	8,63 11 500 ICI/78,1	-	-	-	-	-	-	80	560	
80 000	200	-	-	-	-	-	0,76 1 120 ICI/192	1,6 2 430 ICI/199	-	3,12 4 680 ICI/196	-	6,37 9 550 ICI/196	-	-	-	-	-	-	200	1250	6,3
	160	-	-	-	-	-	-	-	2,9 4 180 C2I/151	4,42 6 500 C2I/154	6,11 9 250 C2I/158	9,12 13 200 C2I/151	12,4 18 500 C2I/156	17,8 26 500 C2I/156	24,8 36 500 C2I/154	31 46 200 C2I/156	36,5 54 500 C2I/156	47,5 73 000 C2I/161	160	1000	
	160	-	-	-	-	-	0,88 1 290 ICI/154	1,74 2 640 ICI/159	1,98 3 000 ICI/159	3,5 5 260 ICI/157	3,88 6 000 ICI/162	7,69 11 550 ICI/157	-	-	-	-	-	-	160	1000	
	125	-	-	-	-	-	-	-	2,92 4 270 C2I/123	4,86 7 500 C2I/129	6,12 9 480 C2I/130	10,2 15 500 C2I/127	11,9 17 860 C2I/125	20,9 30 700 C2I/123	24,4 36 520 C2I/125	34,4 53 000 C2I/129	42,2 65 000 C2I/129	48,9 74 130 C2I/127	125	800	
	125	-	-	-	-	-	1,01 1 480 ICI/123	1,98 3 000 ICI/127	2,5 3 790 ICI/127	4,33 6 500 ICI/126	4,85 7 500 ICI/130	8,53 12 800 ICI/126	-	-	-	-	-	-	125	800	
	100	-	-	-	-	-	-	-	2,94 4 370 C2I/98,2	4,79 7 500 C2I/103	6,27 9 860 C2I/104	10 15 500 C2I/102	12,7 19 360 C2I/100	20,6 30 700 C2I/98,5	25,9 39 430 C2I/100	33,9 53 000 C2I/103	41,5 65 000 C2I/103	52 80 000 C2I/102	100	630	
	100	-	0,17 255 ICI/99,4	0,2 305 ICI/99,4	0,34 525 ICI/103	0,39 615 ICI/103	0,89 1 360 ICI/100	1,98 3 060 ICI/102	2,77 4 210 ICI/100	3,84 6 150 ICI/106	5,65 8 750 ICI/102	7,77 12 440 ICI/106	-	-	-	-	-	-	100	630	

For n_1 lower than 560 min⁻¹ see page 195.

9 - Selection tables (bevel helical gear reducers)

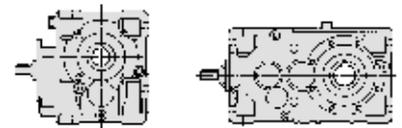

$n_{N2} \cdot L_h$ min ⁻¹ · h	i_N	P_{N2} kW																i_N	n_1	n_{N2} min ⁻¹		
		M_{N2} N m																				
		... / i																				
		50	63	64	80	81	100	125	140	160	180	200	225	250	280	320	321	360				
80 000	90	-	-	-	-	-	-	-	2,95 4 420 C21/87,8	5,03 7 750 C21/90,4	5,54 8 500 C21/90	10,3 15 500 C21/87,9	12,7 19 500 C21/90,3	20,8 31 500 C21/89	25,9 39 610 C21/89,7	35,1 53 160 C21/88,8	43,9 66 450 C21/88,8	52,2 81 300 C21/91,4	90	560	6,3	
	71 000	200	-	-	-	-	-	0,68 1 120 ICI/192	1,44 2 440 ICI/199	-	2,8 4 700 ICI/196	-	5,72 9 590 ICI/196	-	-	-	-	-	-	200	1120	5,6
160		-	-	-	-	-	-	-	2,66 4 240 C21/151	3,98 6 500 C21/154	5,5 9 250 C21/158	8,21 13 200 C21/151	11,2 18 500 C21/156	16 26 500 C21/156	22,4 36 500 C21/154	27,9 46 200 C21/156	32,9 54 500 C21/156	42,8 73 000 C21/161	160	900		
160		-	-	-	-	-	0,79 1 290 ICI/154	1,57 2 640 ICI/159	1,78 3 000 ICI/159	3,15 5 260 ICI/157	3,49 6 000 ICI/162	6,95 11 590 ICI/157	-	-	-	-	-	-	160	900		
125		-	-	-	-	-	-	-	2,6 4 290 C21/123	4,32 7 500 C21/129	5,44 9 500 C21/130	9,06 15 500 C21/127	10,6 17 930 C21/125	18,5 30 700 C21/123	21,7 36 660 C21/125	30,5 53 000 C21/129	37,4 65 000 C21/129	43,6 74 400 C21/127	125	710		
125		-	-	-	-	-	0,9 1 480 ICI/123	1,75 3 000 ICI/127	2,22 3 810 ICI/127	3,84 6 500 ICI/126	4,31 7 500 ICI/130	7,57 12 800 ICI/126	-	-	-	-	-	-	-	125	710	
100		-	-	-	-	-	-	-	2,61 4 370 C21/98,2	4,26 7 500 C21/103	5,59 9 900 C21/104	8,93 15 500 C21/102	11,4 19 430 C21/100	18,3 30 700 C21/98,5	23,1 39 580 C21/100	30,1 53 000 C21/103	36,9 65 000 C21/103	46,2 80 000 C21/102	100	560		
100		-	0,15 255 ICI/99,4	0,18 305 ICI/99,4	0,3 530 ICI/103	0,35 615 ICI/103	0,8 1 360 ICI/100	1,77 3 070 ICI/100	2,51 4 290 ICI/100	3,42 6 150 ICI/106	5,02 8 750 ICI/102	6,91 12 440 ICI/106	-	-	-	-	-	-	100	560		
63 000		200	-	-	-	-	-	0,61 1 130 ICI/192	1,29 2 450 ICI/199	-	2,51 4 710 ICI/196	-	5,13 9 620 ICI/196	-	-	-	-	-	-	200	1000	5
	160	-	-	-	-	-	-	-	2,4 4 320 C21/151	3,54 6 500 C21/154	4,89 9 250 C21/158	7,3 13 200 C21/151	9,93 18 500 C21/156	14,2 26 500 C21/156	19,9 36 500 C21/154	24,8 46 200 C21/156	29,2 54 500 C21/156	38 73 000 C21/161	160	800		
	160	-	-	-	-	-	0,71 1 300 ICI/154	1,4 2 650 ICI/159	1,58 3 000 ICI/159	2,8 5 260 ICI/157	3,1 6 000 ICI/162	6,2 11 630 ICI/157	-	-	-	-	-	-	160	800		
	125	-	-	-	-	-	-	-	2,31 4 310 C21/123	3,83 7 500 C21/129	4,83 9 500 C21/130	8,04 15 500 C21/127	9,48 18 000 C21/125	16,5 30 700 C21/123	19,3 36 790 C21/125	27,1 53 000 C21/129	33,2 65 000 C21/129	38,8 74 680 C21/127	125	630		
	125	-	-	-	-	-	0,8 1 490 ICI/123	1,56 3 000 ICI/127	1,98 3 820 ICI/127	3,41 6 500 ICI/126	3,82 7 500 ICI/130	6,72 12 800 ICI/126	-	-	-	-	-	-	125	630		
56 000	200	-	-	-	-	-	0,55 1 130 ICI/192	1,17 2 460 ICI/199	-	2,27 4 730 ICI/196	-	4,63 9 650 ICI/196	-	-	-	-	-	-	200	900	4,5	
	160	-	-	-	-	-	-	-	2,16 4 370 C21/151	3,14 6 500 C21/154	4,34 9 250 C21/158	6,48 13 200 C21/151	8,81 18 500 C21/156	12,6 26 500 C21/156	17,6 36 500 C21/154	22 46 200 C21/156	25,9 54 500 C21/156	33,7 73 000 C21/161	160	710		
	160	-	-	-	-	-	0,63 1 300 ICI/154	1,25 2 660 ICI/159	1,4 3 000 ICI/159	2,49 5 260 ICI/157	2,76 6 000 ICI/162	5,52 11 670 ICI/157	-	-	-	-	-	-	160	710		
	125	-	-	-	-	-	-	-	2,06 4 320 C21/123	3,4 7 500 C21/129	4,29 9 500 C21/130	7,15 15 500 C21/127	8,43 18 000 C21/125	14,6 30 700 C21/123	17,3 36 930 C21/125	24,1 53 000 C21/129	29,5 65 000 C21/129	34,6 74 960 C21/127	125	560		
	125	-	-	-	-	-	0,71 1 490 ICI/123	1,38 3 000 ICI/127	1,77 3 830 ICI/127	3,03 6 500 ICI/126	3,4 7 500 ICI/130	5,97 12 800 ICI/126	-	-	-	-	-	-	125	560		

For n_1 lower than 560 min⁻¹ see page 195.

9 - Selection tables (bevel helical gear reducers)

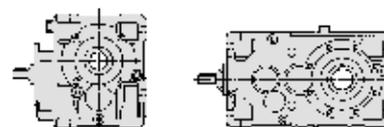

$n_{N2} \cdot L_h$ min ⁻¹ · h	i_N	P_{N2} kW M_{N2} N m ... / i																i_N	n_1 min ⁻¹	n_{N2} min ⁻¹	
		50	63	64	80	81	100	125	140	160	180	200	225	250	280	320	321				360
50 000	200	-	-	-	-	-	0,49 1 130 ICI/192	1,04 2 470 ICI/199	-	2,02 4 750 ICI/196	-	4,13 9 690 ICI/196	-	-	-	-	-	-	200	800	4
	160	-	-	-	-	-	-	-	1,91 4 370 C2I/151	2,79 6 500 C2I/154	3,85 9 250 C2I/158	5,75 13 200 C2I/151	7,82 18 500 C2I/156	11,2 26 500 C2I/156	15,7 36 500 C2I/154	19,5 46 200 C2I/156	23 54 500 C2I/156	29,9 73 000 C2I/161	160	630	
	160	-	-	-	-	-	0,56 1 310 ICI/154	1,11 2 670 ICI/159	1,25 3 000 ICI/159	2,21 5 260 ICI/157	2,44 6 000 ICI/162	4,92 11 720 ICI/157	-	-	-	-	-	-	160	630	
45 000	200	-	-	-	-	-	0,44 1 140 ICI/192	0,93 2 480 ICI/199	-	1,8 4 760 ICI/196	-	3,68 9 730 ICI/196	-	-	-	-	-	-	200	710	3,55
	160	-	-	-	-	-	-	-	1,7 4 370 C2I/151	2,48 6 500 C2I/154	3,42 9 250 C2I/158	5,11 13 200 C2I/151	6,95 18 500 C2I/156	9,95 26 500 C2I/156	13,9 36 500 C2I/154	17,3 46 200 C2I/156	20,5 54 500 C2I/156	26,6 73 000 C2I/161	160	560	
	160	-	-	-	-	-	0,5 1 310 ICI/154	0,99 2 680 ICI/159	1,11 3 000 ICI/159	1,96 5 260 ICI/157	2,17 6 000 ICI/162	4,39 11 760 ICI/157	-	-	-	-	-	-	160	560	
40 000	200	-	-	-	-	-	0,39 1 140 ICI/192	0,83 2 490 ICI/199	-	1,61 4 780 ICI/196	-	3,27 9 750 ICI/196	-	-	-	-	-	-	200	630	3,15
35 500	200	-	-	-	-	-	0,35 1 150 ICI/192	0,74 2 500 ICI/199	-	1,43 4 800 ICI/196	-	2,91 9 750 ICI/196	-	-	-	-	-	-	200	560	2,8

9 For n_1 lower than 560 min⁻¹ see page 195.

9 - Selection tables (bevel helical gear reducers)

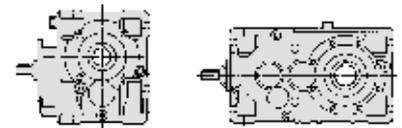

Summary of transmission ratios i , torques M_{N_2} [N m] valid for $n_1 \leq 90 \text{ min}^{-1}$

Train of gears	i_N	Gear reducer size																
		i																
		M_{N_2} [N m]																
		50	63	64	80	81	100	125	140	160	180	200	225	250	280	320	321	360
CI	4	-	-	-	-	-	-	-	-	-	-	4,1 6 320	-	4 ¹⁾ 12 350	-	3,9 21 430	3,9 26 790	-
	5	-	-	-	-	-	-	5,06 2 310	-	4,89 3 830	-	5,11 8 880	-	5,06 18 500	-	4,89 31 430	4,89 39 120	-
	6,3	6,53 173	6,57 321	6,57 400	6,27 665	6,27 744	6,53 1 350	6,57 3 000	-	6,27 5 600	-	6,53 11 350	-	6,57 24 040	-	6,27 40 290	6,27 50 140	-
	8	7,85 195	8 ¹⁾ 324	8 ¹⁾ 405	8,33 690	8,33 811	7,85 1 630	8 3 380	8,15 4 180	8,27 7 380	8,31 8 310	8,27 14 370	8,14 15 850	8,21 25 310	8,15 33 400	7,83 42 420	7,83 52 790	8 ¹⁾ 64 010
	9	-	-	-	-	-	-	-	9 ¹⁾ 4 490	9,04 6 050	9,33 9 340	8,93 12 520	9,33 18 170	9,04 27 850	9 ¹⁾ 36 870	8,75 ¹⁾ 47 390	8,75 ¹⁾ 58 970	9,2 ¹⁾ 73 610
	10	10,3 197	10 ¹⁾ 335	10 ¹⁾ 418	10,4 713	10,4 839	9,81 1 710	10 ¹⁾ 2 970	10,2 3 450	10,3 6 920	10,4 7 730	10,2 13 040	10,3 14 960	10 ¹⁾ 30 380	10,2 35 170	10,2 47 260	10,2 58 120	10 ¹⁾ 67 390
	11,2	-	-	-	-	-	-	-	11,3 3 870	11,4 6 560	11,7 8 250	11,3 11 620	11,7 16 500	11,4 24 310	11,3 ¹⁾ 34 940	11 41 170	11 48 770	11,5 ¹⁾ 77 500
	12,5	12,4 206	12,6 347	12,6 433	13,1 739	13,1 869	12,4 1 650	12,6 3 500	12,9 3 820	13 7 500	13,1 8 440	13 12 100	12,8 14 840	12,6 24 210	12,9 28 370	12,8 38 700	12,8 45 330	12,6 55 730
	14	-	-	-	-	-	-	-	14,2 4 210	14,2 7 250	14,7 9 490	14,2 14 510	14,7 17 010	14,1 28 230	14,2 31 310	14,2 44 900	14,2 52 830	14,5 64 090
	16	15,2 178	15,8 284	15,8 354	16,4 ¹⁾ 627	16,4 ¹⁾ 738	15,2 1 530	15,8 3 040	15,8 4 270	15,5 6 630	16 9 380	15,5 13 500	16 18 480	16 27 250	15,8 33 620	16,3 39 120	16,3 48 900	16 70 660
	18	-	-	-	-	-	-	-	18 ¹⁾ 3 420	18 ¹⁾ 6 010	18,7 7 090	18 ¹⁾ 11 820	18,7 14 040	17,9 24 450	18 ¹⁾ 27 120	18 ¹⁾ 41 060	18 ¹⁾ 48 490	18,4 ¹⁾ 55 000
	20	19,3 181	20 ¹⁾ 294	20 ¹⁾ 367	20,8 ¹⁾ 650	20,8 ¹⁾ 765	19,3 1 490	20 ¹⁾ 3 040	20 ¹⁾ 3 550	19,7 6 580	20,3 7 590	19,7 12 930	20,3 15 000	20,3 27 250	20 ¹⁾ 30 000	19,7 45 630	20,3 52 620	20,3 60 990
	25	24,1 168	25 ¹⁾ 287	25 ¹⁾ 357	26 ¹⁾ 647	26 ¹⁾ 725	24,1 1 170	25 ¹⁾ 2 680	-	24,6 5 260	-	24,6 10 520	-	25,4 21 790	-	-	-	-
	31,5	-	31,3 250	31,3 278	32,5 ¹⁾ 509	32,5 ¹⁾ 633	30,1 1 150	31,3 2 230	-	30,8 4 280	-	30,8 8 740	-	31,7 18 090	-	-	-	-
	ICI	31,5	32,1 200	33 342	33 403	31,4 740	31,4 837	32,8 1 600	32,4 3 210	-	31,4 6 910	-	32,7 13 680	-	-	-	-	-
40		38,6 206	40,1 394	40,1 484	41,8 838	41,8 969	39,4 1 750	39,4 3 500	40,2 4 060	41,4 7 690	41,6 9 160	41,4 15 450	-	-	-	-	-	
50		49 200	50,9 356	50,9 418	53 760	53 851	49,9 1 560	50 ¹⁾ 3 500	49,3 4 440	52,5 7 110	50,8 9 380	52,5 13 970	-	-	-	-	-	
63		60,1 181	63,6 340	63,6 419	66,2 725	66,2 838	61,3 1 530	62,5 ¹⁾ 3 040	62,5 ¹⁾ 4 390	62,5 6 630	64,4 8 720	62,5 13 630	-	-	-	-	-	
80		75,2 181	79,5 340	79,5 410	82,7 725	82,7 833	76,7 1 510	78,1 3 040	78,1 3 070	78,1 6 630	80,5 6 110	78,1 13 500	-	-	-	-	-	
100		-	99,4 291	99,4 355	103 620	103 694	100 1 660	102 3 500	100 4 440	106 7 690	106 9 380	102 15 530	-	-	-	-	-	
125		-	-	-	-	-	123 1 530	127 3 040	127 4 440	126 6 630	130 9 380	126 13 630	-	-	-	-	-	
160		-	-	-	-	-	154 1 530	159 3 040	159 3 770	157 6 570	162 7 580	157 13 630	-	-	-	-	-	
200	-	-	-	-	-	192 1 180	199 2 760	-	196 5 430	-	196 10 860	-	-	-	-	-		
C21	20	-	-	-	-	-	-	20,4 4 640	20,6 7 880	21,4 10 720	20,5 16 000	19,9 19 510	21,5 32 130	20,8 39 720	20,6 56 250	20,6 70 000	21,4 85 740	
	22,4	-	-	-	-	-	-	23,8 ¹⁾ 5 310	23,8 7 880	23,7 11 250	23,6 16 000	23 22 500	23,8 ¹⁾ 32 130	23 ¹⁾ 44 380	23 ¹⁾ 56 250	23 ¹⁾ 70 000	23,7 88 750	
	25	-	-	-	-	-	-	24,5 5 010	25,1 7 880	26 ¹⁾ 10 180	27 16 000	26,3 22 050	27,2 32 130	26,4 44 380	25,1 56 250	25,1 70 000	26 ¹⁾ 88 750	
	28	-	-	-	-	-	-	28,6 5 310	28,9 7 880	28,8 ¹⁾ 11 250	29,5 16 000	30,3 22 500	29,9 32 130	30,1 44 380	28 ¹⁾ 56 250	28 ¹⁾ 70 000	28,8 ¹⁾ 88 750	
	31,5	-	-	-	-	-	-	32 5 150	33,1 7 690	33,2 10 940	33,3 15 630	33,7 21 880	33,1 31 250	33,7 43 130	31,3 56 250	31,3 70 000	32,5 ¹⁾ 88 750	
	35,5	-	-	-	-	-	-	37,5 5 310	37,5 7 880	37,3 10 850	35,3 16 000	36,2 22 500	37,2 32 130	37,5 42 500	36,3 56 250	36,3 70 000	37,3 88 750	
	40	-	-	-	-	-	-	38,7 5 310	39,5 7 880	41 ¹⁾ 10 900	42,6 16 000	41,4 22 500	42,8 32 130	41,6 44 380	39,5 56 250	39,5 70 000	41 ¹⁾ 85 670	
	45	-	-	-	-	-	-	45,1 5 310	45,6 7 880	45,4 11 250	46,6 16 000	47,8 22 500	47,1 32 130	47,5 44 380	44,2 56 250	44,2 70 000	45,4 88 750	
	50	-	-	-	-	-	-	50,4 5 150	52,1 7 690	52,4 10 940	53,9 15 630	53,1 21 880	52,1 31 250	53,1 43 130	51,3 54 630	51,3 66 250	50,5 86 250	
	56	-	-	-	-	-	-	55,4 5 310	57 7 880	56,8 9 920	55,5 16 000	56,9 22 500	56,1 32 130	56,6 44 380	56 56 250	56 70 000	57,6 88 750	
	63	-	-	-	-	-	-	62 5 150	65,2 7 690	65,5 10 940	64,2 15 630	63,2 21 880	62,1 31 250	63,3 43 130	65,1 54 630	65,1 66 250	64 86 250	
	71	-	-	-	-	-	-	70,2 5 310	72,3 7 880	72 ¹⁾ 10 280	70,3 16 000	72,2 22 500	71,2 32 130	71,7 44 380	71,1 56 250	71,1 70 000	73,1 88 750	
	80	-	-	-	-	-	-	78,6 5 150	82,7 7 690	83,1 10 940	81,4 15 630	80,2 21 880	78,8 31 250	80,3 43 130	82,6 54 630	82,6 66 250	81,2 86 250	
	90	-	-	-	-	-	-	87,8 4 680	90,4 7 880	90 ¹⁾ 9 470	87,9 16 000	90,3 20 760	89 32 130	89,7 41 950	88,8 56 250	88,8 70 000	91,4 86 110	
	100	-	-	-	-	-	-	98,2 4 680	103 7 690	104 10 920	102 15 630	100 20 590	98,5 31 250	100 41 920	103 54 630	103 66 250	102 85 430	
	125	-	-	-	-	-	-	123 4 580	129 7 690	130 10 150	127 15 630	125 19 130	123 31 250	125 39 120	129 54 630	129 66 250	127 79 400	
160	-	-	-	-	-	-	151 4 440	154 6 630	158 9 380	151 13 630	156 18 750	156 27 250	154 37 500	156 46 880	156 56 250	161 75 000		

1) Finite transmission ratio.

This page is intentionally left blank.

10 – Dimensions, designs, mounting positions (bevel helical gear reducers)

10.1 - Gear reducers R CI	198
Dimensions	198
Designs (direction of rotation)	199
Mounting positions.....	200
Lubrication details	201
10.2 - Gear reducers R ICI	202
Dimensions	202
Designs (direction of rotation)	202
Mounting positions.....	203
Lubrication details	204
10.3 - Gear reducers R C2I	205
Dimensions	205
Designs (direction of rotation)	205
Mounting positions.....	206
Lubrication details	207

10 - Dimensions, designs, mounting positions (bevel helical gear reducers)

10.1 - Gear reducers R CI

Dimensions

R CI 50 ... 100

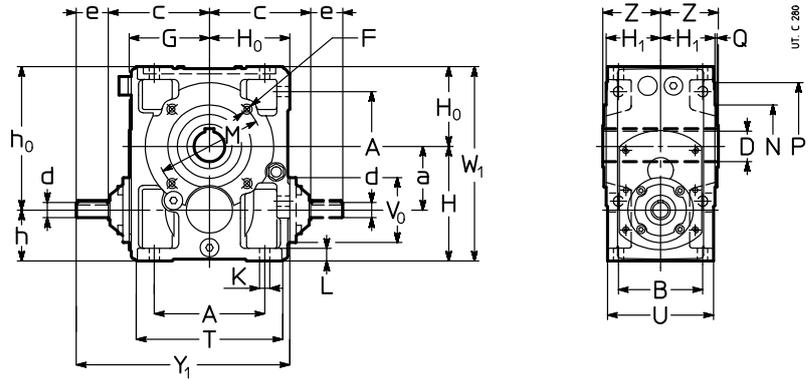
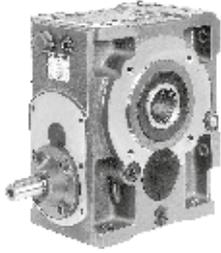

Size	a	A	B	c <i>i_N</i>		D ∅ H7	d	e	Y ₁	d			e			Y ₁	F	H	H ₀	H ₁	h	h ₀	K ∅	L	M ∅	N ∅ h6	P ∅	Q	T	U	V ₀ ∅	W ₁	Z	kg
				≤ 8	≥ 10					<i>i_N</i> ≤ 8			<i>i_N</i> = 10 ... 16																					
50	50	86	75	100	94	24	16	30	197	16	30	191	14	30	191	M6	100	67	49	50	117	9,5	12	85	70	105	2,5	120	95	78	167	53	9	
63	63	102	90	119	108	30	19	40	239	16	30	218	14	30	218	M8	125	80	58,5	62	143	11,5	14	100	80	120	3	143	114	78	205	63	14	
64	63	102	90	119	108	32	19	40	239	16	30	218	14	30	218	M8	125	80	58,5	62	143	11,5	14	100	80	120	3	143	114	78	205	63	14	
80	80	132	106	142	131	38	24	50	292	19	40	271	16	30	261	M10	150	100	69,5	70	180	14	17	130	110	160	3,5	180	135	86	250	75	25	
81	80	132	106	142	131	40	24	50	292	19	40	271	16	30	261	M10	150	100	69,5	70	180	14	17	130	110	160	3,5	180	135	86	250	75	25	
100	100	172	131	168	157	48	28	60	353	24	50	332	19	40	322	M12	180	125	84,5	80	225	16	20	165	130	200	3,5	228	165	104	305	90	45	

R CI 125 ... 360

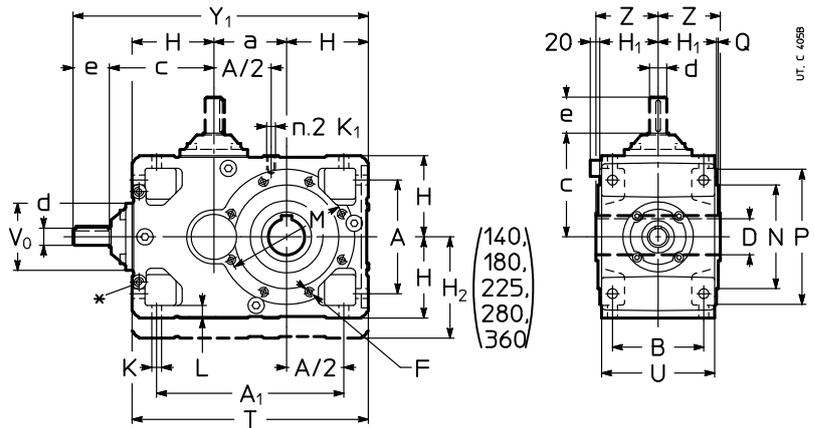
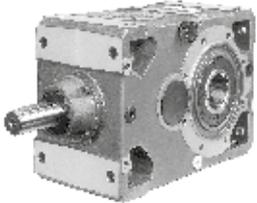

Size	a	A	A ₁	B	c <i>i_N</i>		D ∅ H7	d	e	Y ₁	d			e			Y ₁	F	H	H ₁	H ₂	K ∅	K ₁	L	M ∅	N ∅ h6	P ∅	Q	T	U	V ₀ ∅	Z	kg
					≤ 8	≥ 9					<i>i_N</i> ≤ 8			<i>i_N</i> = 9 ... 16																			
125	125	212	337	162	202	188	60	38	80	557	28	60	523	24	50	513	3)	150	103,5	-	18	M12	23	215	180	250	4	425	201	122	110	89	
140	140	212	352	162	202	188	70	38	80	572	28	60	538	24	50	528	3)	150	103,5	180	18	M12	23	265	230	300	4	440	201	122	125	102	
					≤ 9	≥ 10					<i>i_N</i> ≤ 9																						<i>i_N</i> = 10 ... 16
160	160	252	412	201	246	226	80	48	110	696	38	80	646	32	80	646	M16	180	128,5	-	22	M16	28	265	230	300	4	520	249	155	136	158	
					≤ 8	≥ 9					<i>i_N</i> ≤ 8																						<i>i_N</i> = 9 ... 16
180	180	252	432	201	246	226	90	48	110	716	38	80	666	32	80	666	M16	180	128,5	225	22	M16	28	300	250	350	5	540	249	155	150	181	
					≤ 9	≥ 10					<i>i_N</i> ≤ 9																						<i>i_N</i> = 10 ... 16
200	200	320	520	250	305	282	100	55	110	840	48	110	817	38	80	787	3)	225	158	-	27	M20	34	350	300	400	5	650	307	190	167	282	
					≤ 8	≥ 9					<i>i_N</i> ≤ 8																						<i>i_N</i> = 9 ... 16
225	225	320	545	250	305	282	110	55	110	865	48	110	842	38	80	812	M20	225	158	280	27	M20	34	400	350	450	5	675	307	190	180	324	
					≤ 9	≥ 10					<i>i_N</i> ≤ 9																						<i>i_N</i> = 10 ... 16
250	250	396	646	310	380	357	125	70	140	1050	55	110	997	48	110	997	3)	280	195	-	33	M24	42	500	450	550	5	810	380	238	206	495	
					≤ 10	≥ 11,2					<i>i_N</i> ≤ 10																						<i>i_N</i> = 11,2 ... 16
280	280	396	676	310	380	357	140	70	140	1080	55	110	1027	48	110	1027	M24	280	195	355	33	M24	42	500	450	550	5	840	380	238	222	568	
					≤ 11,2	≥ 12,5					<i>i_N</i> ≤ 11,2																						<i>i_N</i> = 12,5 ... 16
320, 321	320	510	830	386	480	480	160	90	170	1325	70	140	1295	70	140	1295	3)	355	241	-	39	M30	52	600	550	660	6	1030	470	290	254	882	
					≤ 11,2	≥ 12,5					<i>i_N</i> ≤ 10																						<i>i_N</i> = 11,2 ... 16
360	360	510	870	386	480	480	180	90	170	1365	70	140	1335	70	140	1335	M30	355	241	450	39	M30	52	600	550	660	6	1070	470	290	273	1013	

See notes on following page.

10 - Dimensions, designs, mounting positions (bevel helical gear reducers)

Designs (direction of rotation)

R CI 50 ... 100

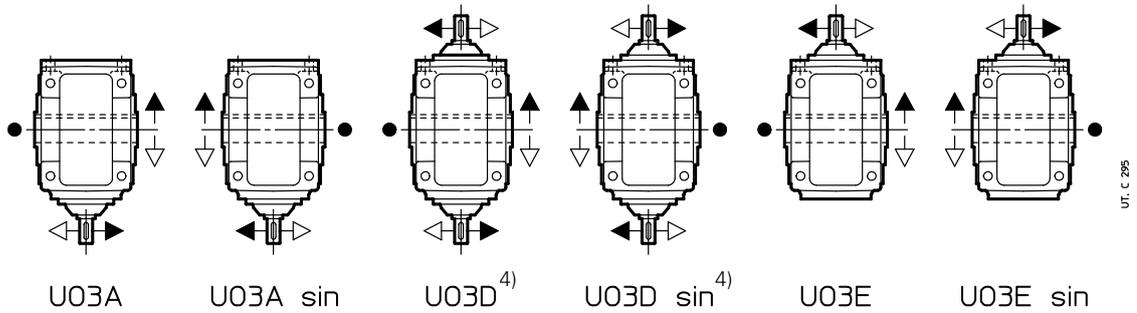

R CI 125 ... 360

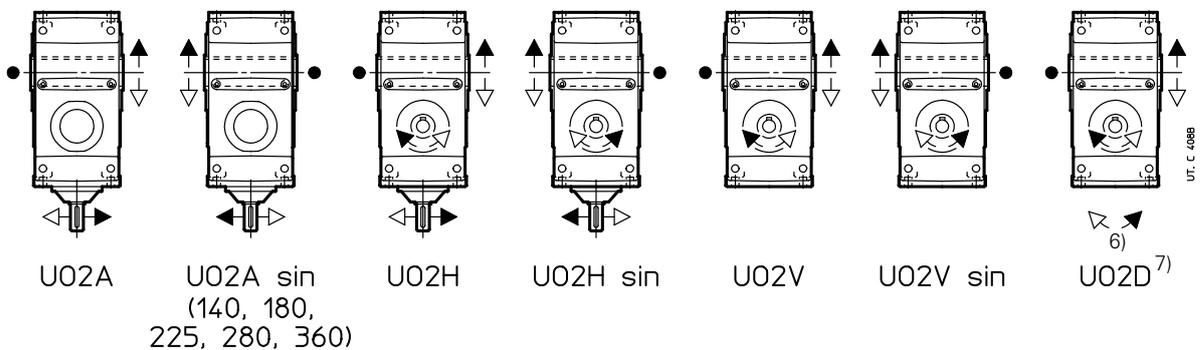

- Position of reference groove (see ch. 6) for radial load verification.
- * Machined surface and N. 2 threaded holes (dimensions in ch. 6 «Gear reducer input face») on opposite side (not in view) too.
- 1) Working length of thread 2 · F.
- 2) Working length of thread 2 · K1.
- 3) For dimension, number and angular position see ch. 6.
- 4) Not possible for size 50 with $i_N < 8$.
- 6) Direction of rotation of the second high speed shaft overhang not in view.
- 7) Design not possible for sizes 140, 180, 225, 280 and 360.



10 - Dimensions, designs, mounting positions (bevel helical gear reducers)

Mounting positions

Unless otherwise stated, gear reducers are supplied in mounting position **B3** (see ch. 2).

R CI 50 ... 100

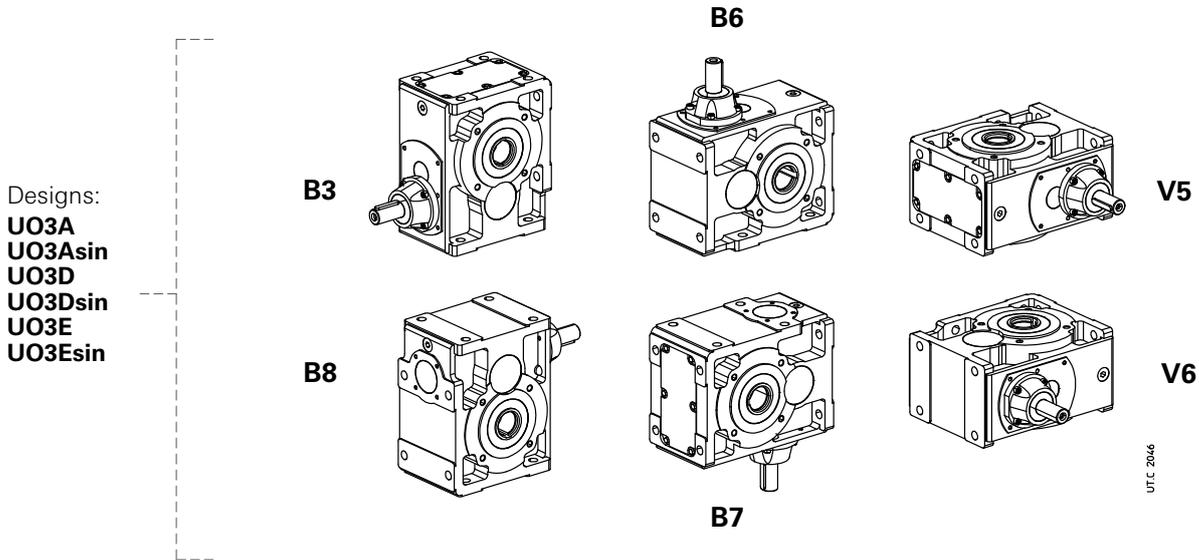

R CI 125 ... 360

10

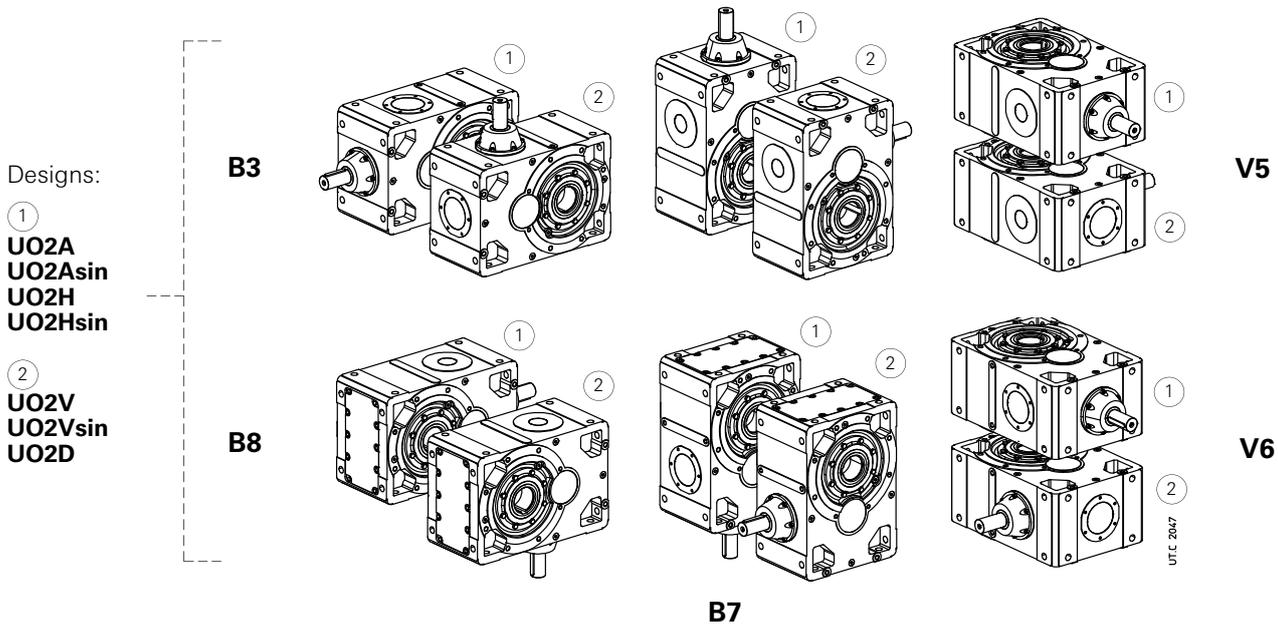

Oil quantity R CI 50 ... 360

Stated oil quantities [l] are approximate for provisioning. The exact oil quantity the gear reducer is to be filled with is defined by the level plug.

Mounting position	50	63, 64	80, 81	100	125	140	160	180	200	225	250	280	320, 321	360
B3	0,4	0,8	1,3	2,6	5,3	8,2	10,5	16,1	20,5	31,5	40	61	78	120
B8	0,6	1	2	3,8	5,3	5,5	10,5	10,7	20,5	21	40	41	78	80
B6	0,4	0,8	1,3	2,9	7	8,7	13,7	17	26,7	33,3	52	65	102	127
B7	0,4	0,8	1,3	2,9	7,6	9,7	15	19	29	37	57	72	111	141
V5	0,45	0,95	1,8	3,5	8,9	10,3	17,5	20,1	34	39,3	67	77	130	150
V6	0,45	0,95	1,8	3,5	8,9	10,3	17,5	20,1	34	39,3	67	77	130	150

Lubrication details

R CI 100

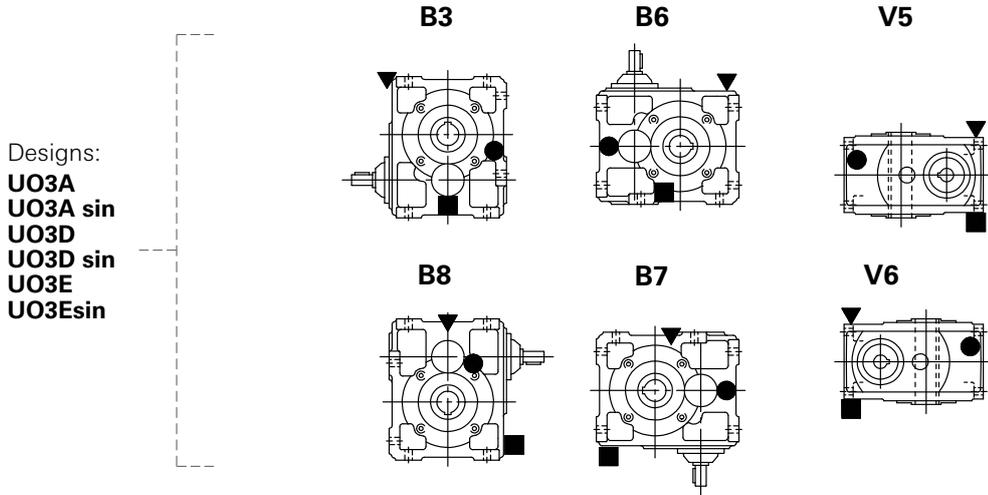

R CI 125 ... 360

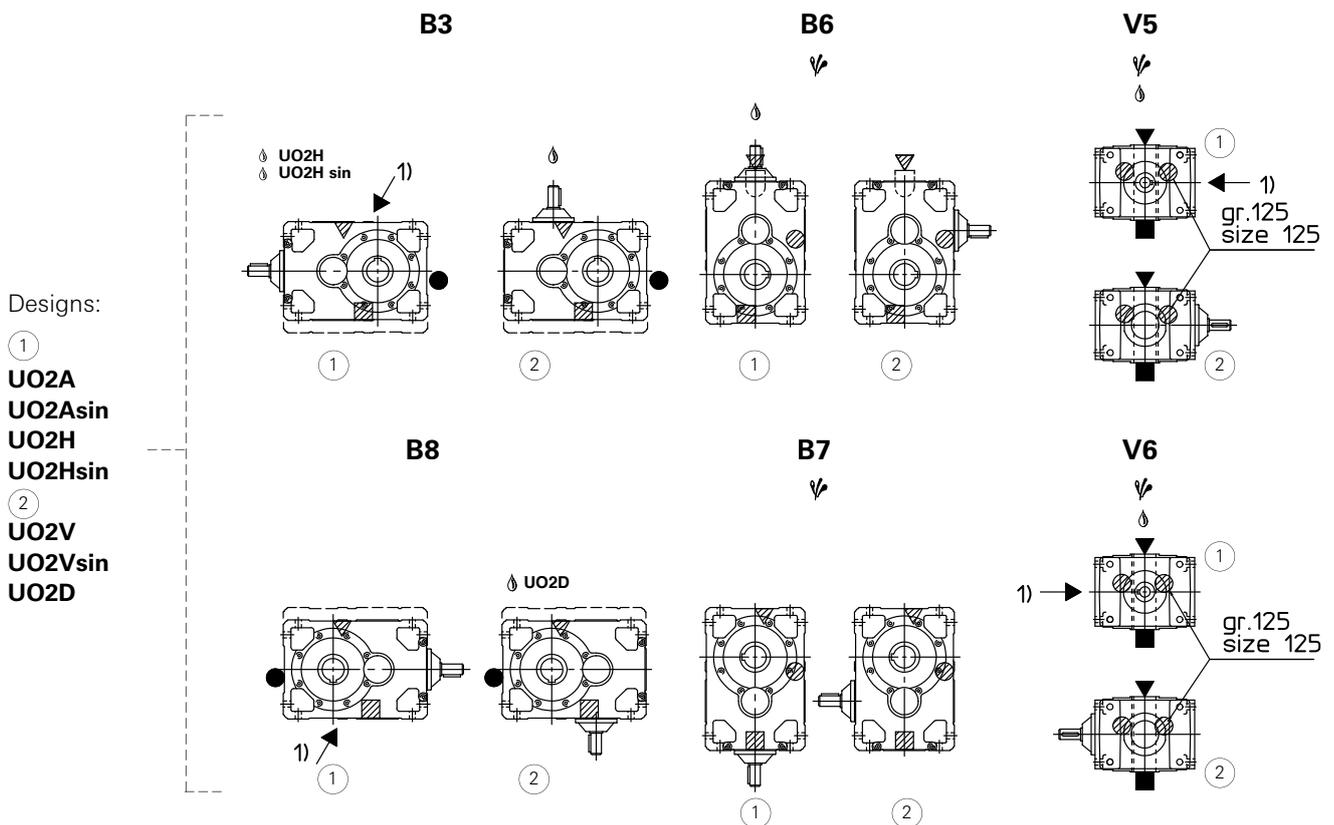

- 1) Position of intermediate hole for mounting position identification.
- ▽ Possible high oil splash: for the corrective factor ft_3 of nominal thermal power P_{tN} see ch. 4.
- ⚡ Possible bearing lubrication pump or high speed shaft lubrication device (see ch. 17 (19)).

- ▼ oil filler plug
- oil level plug
- oil drain plug
- ▽ oil filler plug on opposite side (not in view)
- oil level plug on opposite side (not in view)
- oil drain plug on opposite side (not in view)

10 - Dimensions, designs, mounting positions (bevel helical gear reducers)

10.2 - Gear reducers R ICI

Dimensions

R ICI 50 ... 200

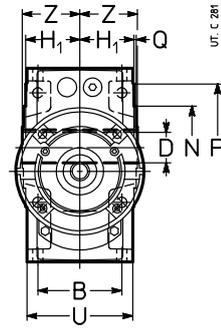
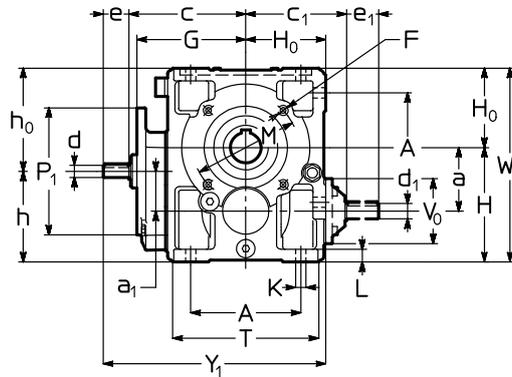
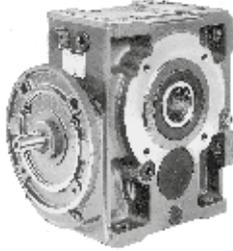

Size	a	a ₁	A	B	c	c ₁	D ∅ H7	d ∅	e	Y ₁	d ₁ ∅	e ₁	d ₁ ∅	e ₁	F	G	H	H ₀	H ₁	h	h ₀	K ∅	L	M ∅	N ∅ h6	P ∅	P ₁	Q	T	U	V ₀ ∅	W ₁	Z	kg			
								<i>i_N ≤ 80</i>				<i>i_N ≥ 100</i>	<i>i_N ≤ 40</i>	<i>i_N ≥ 50</i>	1)			h ₁₁	h ₁₁	h ₁₂	h ₁₁	h ₁₁															
50	50	40	86	75	107	94	24	11	23	197	-	-	-	16	30	14	30	M6	98	100	67	49	90	77	9,5	12	85	70	105	140 ³⁾	2,5	120	95	78	167	53	11
63	63	50	102	90	127	108	30	14	30	237	14	30	237	16	30	14	30	M8	118	125	80	58,5	112	93	11,5	14	100	80	120	160 ³⁾	3	143	114	78	205	63	17
80	80	50	132	106	147	131	38	14	30	277	14	30	277	19	40	16	30	M10	138	150	100	69,5	120	130	14	17	130	110	160	160 ³⁾	3,5	180	135	86	250	75	28
81	80	50	132	106	147	131	40	14	30	277	14	30	277	19	40	16	30	M10	138	150	100	69,5	120	130	14	17	130	110	160	160 ³⁾	3,5	180	135	86	250	75	28
100	100	62,5	172	131	181	157	48	19	40	346	16	30	336	24	50	19	40	M12	170	180	125	84,5	143	162	16	20	165	130	200	200	3,5	228	165	104	305	90	50
125	125	80	212	162	216	188	60	24	50	416	19	40	406	28	60	24	50	2)	205	225	150	103,5	180	195	18	23	215	180	250	200	4	274	201	122	375	110	88
140	140	80	212	162	216	188	70	24	50	416	19	40	406	28	60	24	50	2)	205	240	150	103,5	180	210	18	23	265	230	300	200	4	274	201	122	390	125	102
160	160	100	252	201	258	226	80	28	60	498	24	50	488	38	80	32	80	2)	247	280	180	128,5	220	240	22	28	265	230	300	250	4	328	249	155	460	136	164
180	180	100	252	201	258	226	90	28	60	498	24	50	488	38	80	32	80	2)	247	300	180	128,5	220	260	22	28	300	250	350	250	5	328	249	155	480	150	188
200	200	125	320	250	318	282	100	32	80	623	32	80	623	48	110	38	80	2)	305	355	225	158	280	300	27	34	350	300	400	300	5	410	307	190	580	167	296

Designs (direction of rotation)

R ICI 50 ... 200

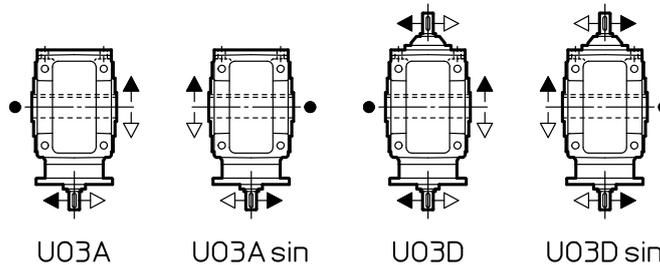

● Position of reference groove (see ch. 6) for radial load verification.

1) Working length of thread 2 · F.

2) For dimension, number and angular position see ch. 6.

3) Square flange: for dimensions see ch. 6.

4) For sizes 140 and 180 the dimensions are valid for $i_N \leq 50$ and $i_N = 100$.

5) For sizes 140 and 180 the dimensions are valid for the following ratios $i_N = 63$, $i_N = 80$, $i_N = 125$ and $i_N = 160$.



10 - Dimensions, designs, mounting positions (bevel helical gear reducers)

Mounting positions

Unless otherwise stated, gear reducers are supplied in mounting position **B3** (see ch. 2).

R ICI 50 ... 200

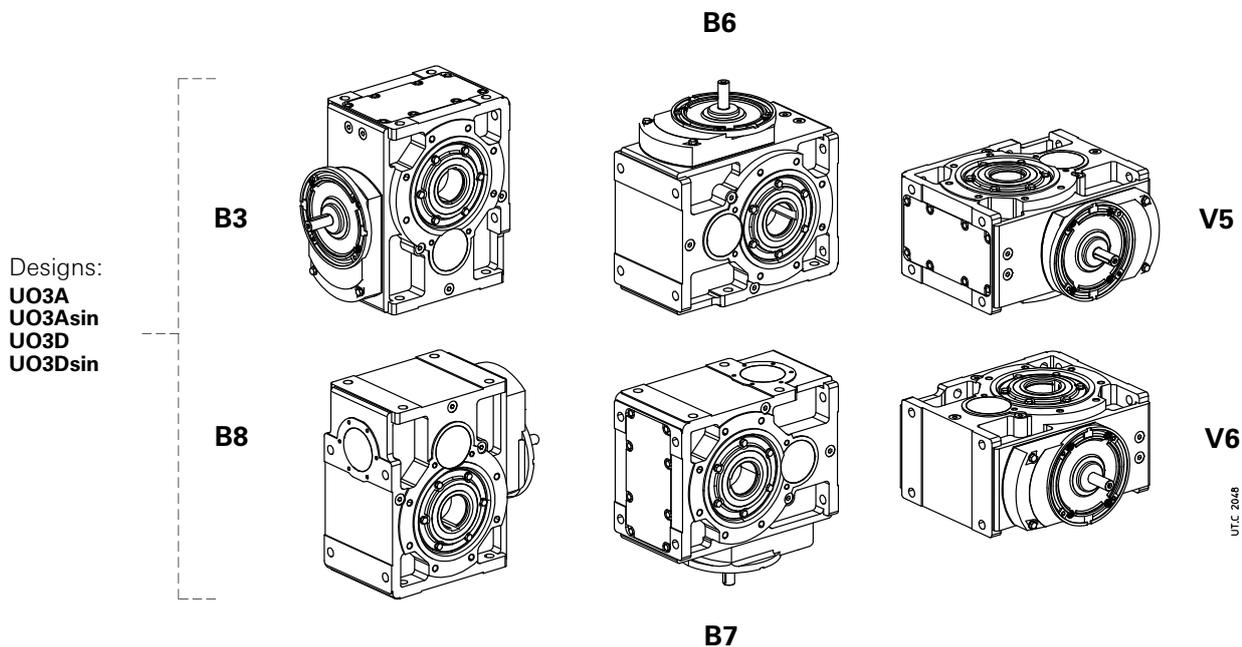

Oil quantity **R ICI 50 ... 200**

Stated oil quantities [l] are approximate for provisioning. The exact oil quantity the gear reducer is to be filled with is defined by the level plug.

Mounting position	50	63, 64	80, 81	100	125	140	160	180	200
B3	0,45	1	1,6	3	6	6,8	10,6	11,9	20
B8	0,65	1,2	2,2	4,2	9	10,6	16	18,9	30
B6	0,8	1,6	2,7	5,8	11,6	13,7	21	24,8	40
B7	0,45	1	1,6	3	6	6,8	10,6	11,9	20
V5	0,5	1,15	2	3,8	7	8,3	13	15,3	24
V6	0,5	1,15	2	3,8	7	8,3	13	15,3	24

10 - Dimensions, designs, mounting positions (bevel helical gear reducers)

Lubrication details

R ICI 100 ... 200

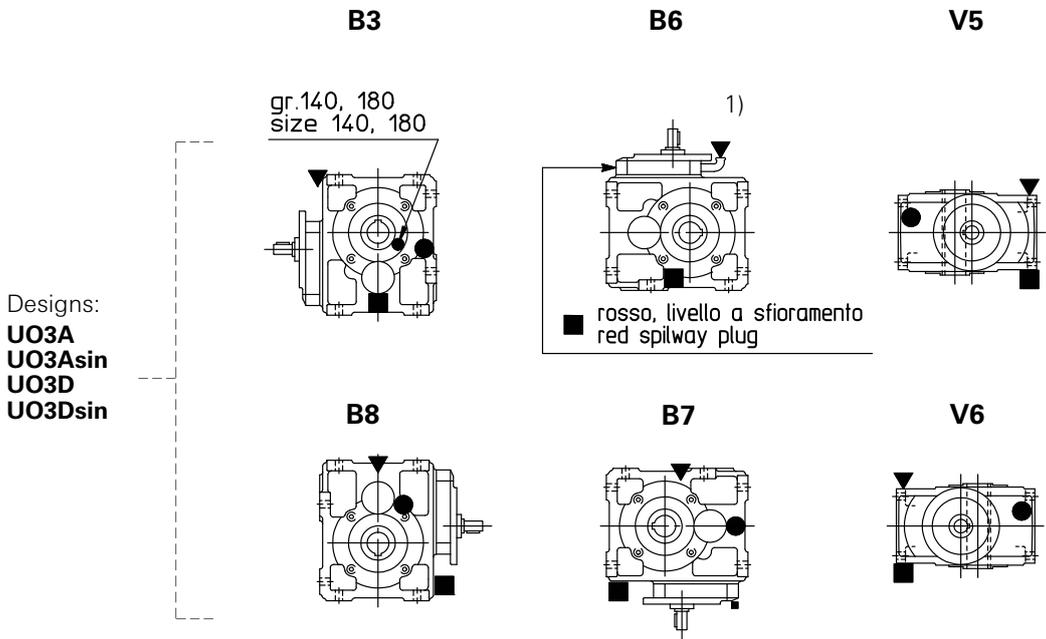

10

1) See also ch. 6 page 43.

- ▼ oil filler plug
- oil level plug
- oil drain plug

10 - Dimensions, designs, mounting positions (bevel helical gear reducers)

10.3 - Gear reducers R C2I

Dimensions

R C2I 140 ... 360

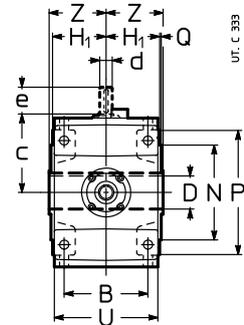
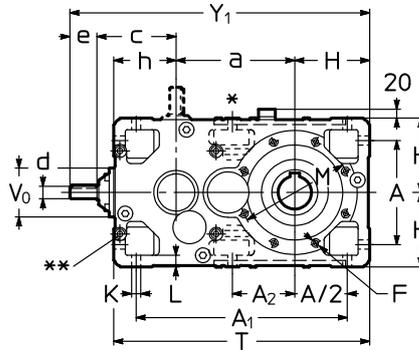
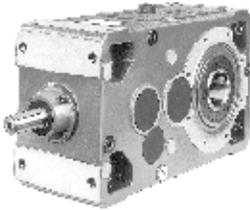

Size	a	A	A ₁	A ₂	B	c		D ∅ H7	d	e	Y ₁	d e Y ₁			F	H	H ₁	h	K ∅	L	M ∅	N ∅ h6	P ∅	Q	T	U	V ₀ ∅	Z	kg			
						≤ 31,5	≥ 35,5					∅	∅	Y ₁																1)	h11	h12
140	240	212	427	127	162	168	157	70	28	60	618	24	50	597	19	40	587	2)	150	103,5	125	18	23	265	230	300	4	515	201	104	125	111
160	285	252	507	150*	201	202	188	80	38	80	747	28	60	713	24	50	703	M16	180	128,5	150	22	28	265	230	300	4	615	249	122	136	182
180	305	252	527	170	201	202	188	90	38	80	767	28	60	723	24	50	723	M16	180	128,5	150	22	28	300	250	350	5	635	249	122	150	200
200	360	320	635	196*	250	246	226	100	48	110	941	38	80	891	32	80	891	2)	225	158	180	27	34	350	300	400	5	765	307	155	167	321
225	385	320	660	223	250	246	226	110	48	110	966	38	80	916	32	80	916	M20	225	158	180	27	34	400	350	450	5	790	307	155	180	352
250	450	396	791	247*	310	305	282	125	55	110	1145	48	110	1092	38	80	1092	2)	280	195	225	33	42	500	450	550	5	955	380	190	206	563
280	480	396	821	277	310	305	282	140	55	110	1175	48	110	1122	38	80	1122	M24	280	195	225	33	42	500	450	550	5	985	380	190	222	617
320, 321	570	510	1005	318*	386	380	357	160	70	140	1445	55	110	1392	48	110	1392	2)	355	241	280	39	52	600	550	660	6	1205	470	238	254	991
360	610	510	1045	358	386	380	357	180	70	140	1485	55	110	1432	48	110	1432	M30	355	241	280	39	52	600	550	660	6	1245	470	238	273	1086

10

Designs (direction of rotation)

R C2I 140 ... 360

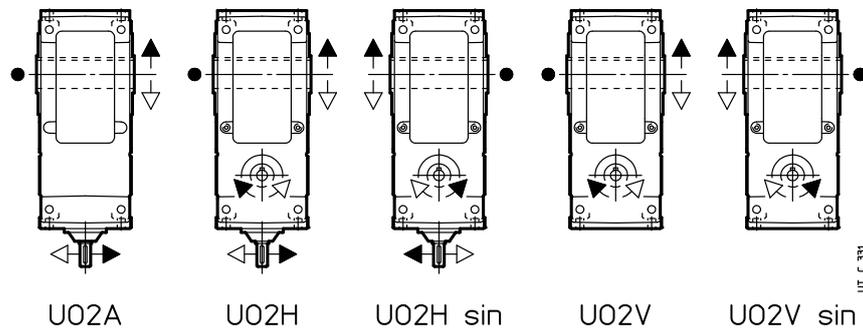

- Position of reference groove (see ch. 6) for radial load verification.
- * Only No. 2 holes M 16×32 (size 160), M 20×38 (size 200), M 24×46 (size 250) and M 30×58 (sizes 320 and 321) and not for design U02A.
- * *Machined surface and N.4 threaded holes (dimensions in ch. 6 «Gear reducer input face») on opposite side (not in view) too.
- 1) Working length of thread 2 · F.
- 2) For dimension, number and angular position see ch. 6.
- 3) The housing of this design is not pre-arranged for the other designs.



42

10 - Dimensions, designs, mounting positions (bevel helical gear reducers)

Mounting positions

Unless otherwise stated, gear reducers are supplied in mounting position **B3** (see ch. 2).

R C2I 140 ... 360

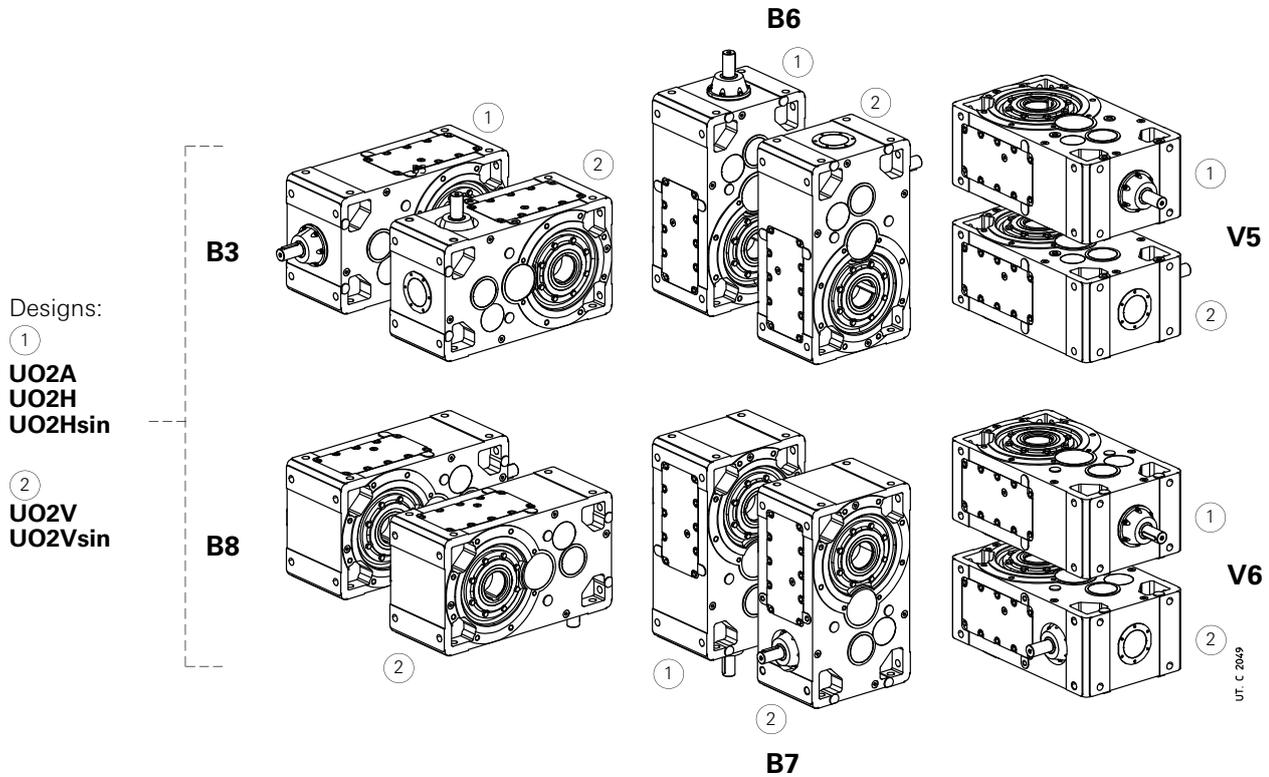

10

Oil quantity R C2I 140 ... 360

Stated oil quantities [l] are approximate for provisioning. The exact oil quantity the gear reducer is to be filled with is defined by the level plug.

Mounting position	140	160	180	200	225	250	280	320, 321	360
B3	6,6	12	13	25	26	47	51	97	100
B8	6,6	12	13	25	26	47	51	97	100
B6	10,8	20	21	39	41	75	80	152	156
B7	9,7	18	19	35	37	67	72	137	140
V5	9,7	18	19	35	37	67	72	137	140
V6	9,7	18	19	35	37	67	72	137	140

Lubrication details

R C2I 140 ... 360

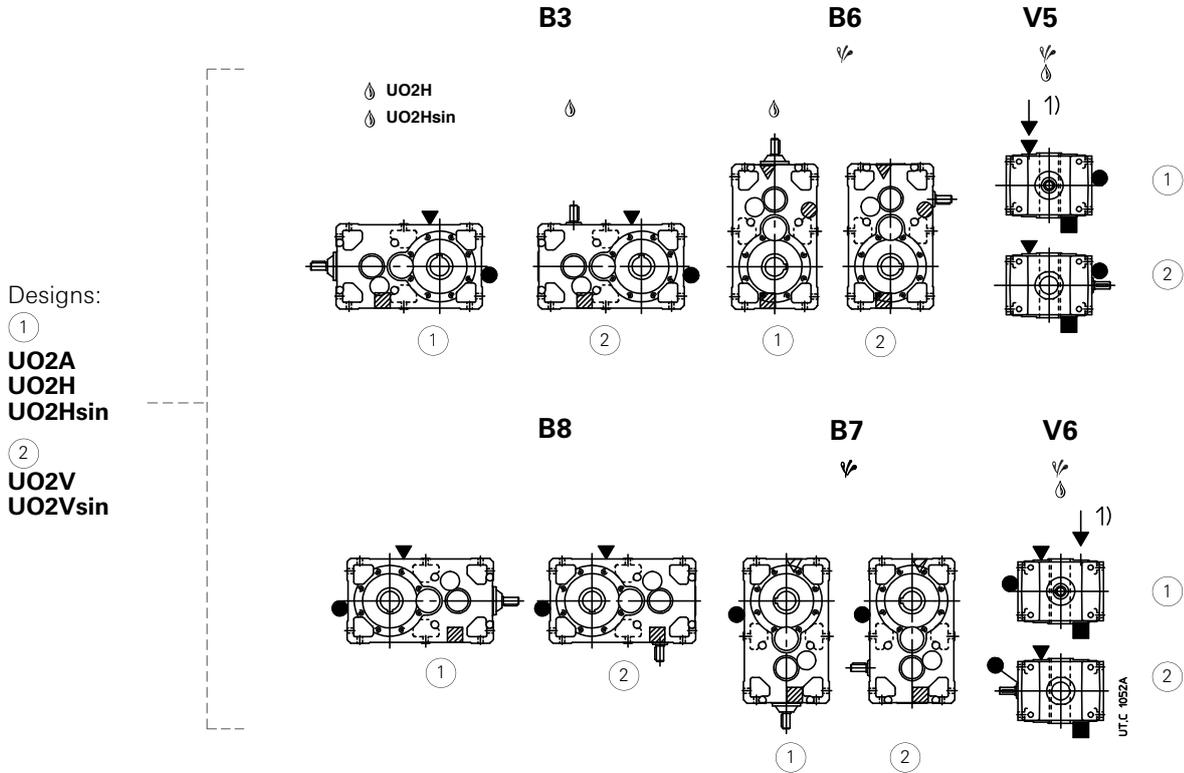

1) Position of intermediate hole for mounting position identification.
 ♣ Possible high oil splash: for the corrective factor ft_3 of nominal thermal power P_{tN} see ch. 4.
 ⚙ Possible bearing lubrication pump or high speed shaft lubrication device (see ch. 17 (19)).

▼ oil filler plug
 ● oil level plug
 ■ oil drain plug
 ▾ oil filler plug on opposite side (not in view)
 ○ oil level plug on opposite side (not in view)
 ▨ oil drain plug on opposite side (not in view)

This page is intentionally left blank.

11 – Selection tables

(helical gearmotors)

11 - Selection tables (helical gearmotors)

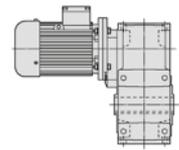

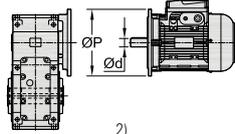
P_1 kW	n_2 min ⁻¹	M_2 N m	f_s		i
1)				2)	
0,09	3,42	231	1,5	MR 4I 63 - 11 × 140 63 A	6 263
	3,29	240	1,7	MR 4I 64 - 11 × 140 63 A	6 274
	4,28	185	2,12	MR 4I 63 - 11 × 140 63 A	6 210
	4,11	193	2,5	MR 4I 64 - 11 × 140 63 A	6 219
	5,21	152	2,65	MR 4I 63 - 11 × 140 63 A	6 173
	6,31	125	3,15	MR 4I 63 - 11 × 140 63 A	6 143
	7,68	103	3,75	MR 4I 63 - 11 × 140 63 A	6 117
	10,7	76	3,55	MR 3I 63 - 11 × 140 63 A	6 84,3
	14	58	1,18	MR 3I 40 - 11 × 140 63 A	6 64,3
	14,2	57	2,36	MR 3I 50 - 11 × 140 63 A	6 63,2
	16,9	47,8	1,8	MR 3I 40 - 11 × 140 63 A	6 53,2
	17,3	46,7	3,35	MR 3I 50 - 11 × 140 63 A	6 52
	20,5	39,4	2,5	MR 3I 40 - 11 × 140 63 A	6 43,9
	23,3	34,7	2	MR 3I 40 - 11 × 140 63 A	6 38,7
	28,1	28,7	3	MR 3I 40 - 11 × 140 63 A	6 32
	34,1	23,7	4	MR 3I 40 - 11 × 140 63 A	6 26,4
	33,7	24,5	2,8	MR 2I 40 - 11 × 140 63 A	6 26,7
	44,1	18,3	5,3	MR 3I 40 - 11 × 140 63 A	6 20,4
	40,7	20,3	4	MR 2I 40 - 11 × 140 63 A	6 22,1
	49,4	16,7	5,6	MR 2I 40 - 11 × 140 63 A	6 18,2
56,1	14,7	4,5	MR 2I 40 - 11 × 140 63 A	6 16,1	
67,7	12,2	6,7	MR 2I 40 - 11 × 140 63 A	6 13,3	
82,2	10	9,5	MR 2I 40 - 11 × 140 63 A	6 11	
0,12	3,42	308	1,12	MR 4I 63 - 11 × 140 63 B	6 263
	3,29	321	1,32	MR 4I 64 - 11 × 140 63 B	6 274
	4,28	247	1,6	MR 4I 63 - 11 × 140 63 B	6 210
	4,11	257	1,9	MR 4I 64 - 11 × 140 63 B	6 219
	5,32	198	1,7	MR 4I 63 - 11 × 140 63 A	4 263
	5,12	206	2	MR 4I 64 - 11 × 140 63 A	4 274
	5,21	203	1,9	MR 4I 63 - 11 × 140 63 B	6 173
	4,99	211	2,36	MR 4I 64 - 11 × 140 63 B	6 180
	6,65	158	2,5	MR 4I 63 - 11 × 140 63 A	4 210
	8,1	130	3	MR 4I 63 - 11 × 140 63 A	4 173
	9,81	107	3,75	MR 4I 63 - 11 × 140 63 A	4 143
	10,7	101	2,65	MR 3I 63 - 11 × 140 63 B	6 84,3
	14	77	0,9	MR 3I 40 - 11 × 140 63 B	6 64,3
	14,2	76	1,8	MR 3I 50 - 11 × 140 63 B	6 63,2
	11,9	88	4,5	MR 4I 63 - 11 × 140 63 A	4 117
	13,3	81	4	MR 3I 63 - 11 × 140 63 B	6 67,5
	16,9	64	1,32	MR 3I 40 - 11 × 140 63 B	6 53,2
	17,3	62	2,5	MR 3I 50 - 11 × 140 63 B	6 52
	16,6	65	4,25	MR 3I 63 - 11 × 140 63 A	4 84,3
	21,8	49,5	1,4	MR 3I 40 - 11 × 140 63 A	4 64,3
	20,5	53	1,9	MR 3I 40 - 11 × 140 63 B	6 43,9
	22,1	48,7	2,8	MR 3I 50 - 11 × 140 63 A	4 63,2
	26,3	41	2	MR 3I 40 - 11 × 140 63 A	4 53,2
	26,9	40	3,75	MR 3I 50 - 11 × 140 63 A	4 52
	31,9	33,8	2,8	MR 3I 40 - 11 × 140 63 A	4 43,9
	36,2	29,8	2,24	MR 3I 40 - 11 × 140 63 A	4 38,7
	33,7	32,6	2,12	MR 2I 40 - 11 × 140 63 B	6 26,7
	43,7	24,6	3,35	MR 3I 40 - 11 × 140 63 A	4 32
	40,7	27	3	MR 2I 40 - 11 × 140 63 B	6 22,1
	53,1	20,3	4,75	MR 3I 40 - 11 × 140 63 A	4 26,4
52,4	21	3,15	MR 2I 40 - 11 × 140 63 A	4 26,7	
68,5	15,7	6	MR 3I 40 - 11 × 140 63 A	4 20,4	
63,3	17,4	4,75	MR 2I 40 - 11 × 140 63 A	4 22,1	
76,9	14,3	6,3	MR 2I 40 - 11 × 140 63 A	4 18,2	
87,2	12,6	5,3	MR 2I 40 - 11 × 140 63 A	4 16,1	
105	10,4	7,5	MR 2I 40 - 11 × 140 63 A	4 13,3	
128	8,6	10,6	MR 2I 40 - 11 × 140 63 A	4 11	
165	6,7	12,5	MR 2I 40 - 11 × 140 63 A	4 8,48	

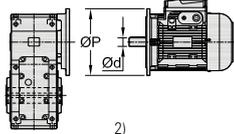
P_1 kW	n_2 min ⁻¹	M_2 N m	f_s		i
1)				2)	
0,18	2,86	552	1,32	MR 4I 80 - 14 × 160 71 A	6 314
	2,86	552	1,5	MR 4I 81 - 14 × 160 71 A	6 314
	3,42	463	1,6	MR 4I 80 - 14 × 160 71 A	6 263
	3,42	463	1,8	MR 4I 81 - 14 × 160 71 A	6 263
	4,72	335	1	MR 4I 63 - 14 × 160 71 A	6 191
	4,54	348	1,18	MR 4I 64 - 14 × 160 71 A	6 198
	4,27	371	2,24	MR 4I 80 - 14 × 160 71 A	6 211
	4,27	371	2,65	MR 4I 81 - 14 × 160 71 A	6 211
	5,32	297	1,12	MR 4I 63 - 11 × 140 63 B	4 263
	5,12	309	1,32	MR 4I 64 - 11 × 140 63 B	4 274
	5,9	268	1,5	MR 4I 63 - 14 × 160 71 A	6 152
	5,67	279	1,7	MR 4I 64 - 14 × 160 71 A	6 159
	5,67	279	2,8	MR 4I 80 - 14 × 160 71 A	6 159
	5,67	279	3,55	MR 4I 81 - 14 × 160 71 A	6 159
	6,65	238	1,7	MR 4I 63 - 11 × 140 63 B	4 210
	6,39	248	2	MR 4I 64 - 11 × 140 63 B	4 219
	7,19	220	1,8	MR 4I 63 - 14 × 160 71 A	6 125
	6,49	244	3,35	MR 4I 80 - 14 × 160 71 A	6 139
	8,1	195	2	MR 4I 63 - 11 × 140 63 B	4 173
	7,76	204	2,5	MR 4I 64 - 11 × 140 63 B	4 180
	9,81	161	2,5	MR 4I 63 - 11 × 140 63 B	4 143
	11,9	132	3	MR 4I 63 - 11 × 140 63 B	4 117
	14,7	110	2,5	MR 3I 63 - 14 × 160 71 A	6 61,1
	19,5	83	1,6	MR 3I 50 - 14 × 160 71 A	6 46,2
	16,6	97	2,8	MR 3I 63 - 11 × 140 63 B	4 84,3
	21,8	74	0,95	MR 3I 40 - 11 × 140 63 B	4 64,3
	22,1	73	1,8	MR 3I 50 - 11 × 140 63 B	4 63,2
	26,3	61	1,4	MR 3I 40 - 11 × 140 63 B	4 53,2
	26,9	60	2,5	MR 3I 50 - 11 × 140 63 B	4 52
	31,9	51	1,9	MR 3I 40 - 11 × 140 63 B	4 43,9
36,2	44,6	1,5	MR 3I 40 - 11 × 140 63 B	4 38,7	
33,7	49	1,4	MR 2I 40 - 14 × 140 71 A	** 6 26,7	
33,1	48,9	3,75	MR 3I 50 - 11 × 140 63 B	4 42,4	
36,9	44,7	3	MR 2I 50 - 14 × 160 71 A	6 24,4	
43,7	37	2,24	MR 3I 40 - 11 × 140 63 B	4 32	
40,7	40,5	2	MR 2I 40 - 14 × 140 71 A	** 6 22,1	
39,7	40,7	5	MR 3I 50 - 11 × 140 63 B	4 35,3	
53,1	30,5	3,15	MR 3I 40 - 11 × 140 63 B	4 26,4	
52,4	31,5	2,12	MR 2I 40 - 11 × 140 63 B	4 26,7	
68,5	23,6	4	MR 3I 40 - 11 × 140 63 B	4 20,4	
63,3	26,1	3,15	MR 2I 40 - 11 × 140 63 B	4 22,1	
76,9	21,5	4,25	MR 2I 40 - 11 × 140 63 B	4 18,2	
87,2	18,9	3,55	MR 2I 40 - 11 × 140 63 B	4 16,1	
105	15,7	5	MR 2I 40 - 11 × 140 63 B	4 13,3	
128	12,9	7,1	MR 2I 40 - 11 × 140 63 B	4 11	
165	10	8,5	MR 2I 40 - 11 × 140 63 B	4 8,48	
0,25	2,86	767	1,12	MR 4I 81 - 14 × 160 71 B	6 314
	3,42	642	1,12	MR 4I 80 - 14 × 160 71 B	6 263
	3,42	642	1,32	MR 4I 81 - 14 × 160 71 B	6 263
	4,45	493	1,5	MR 4I 80 - 14 × 160 71 A	4 314
	4,45	493	1,7	MR 4I 81 - 14 × 160 71 A	4 314
	4,27	515	1,6	MR 4I 80 - 14 × 160 71 B	6 211
	4,27	515	1,9	MR 4I 81 - 14 × 160 71 B	6 211
	5,12	429	1	MR 4I 64 - 11 × 140 63 C	4 274
	5,9	372	1,06	MR 4I 63 - 14 × 160 71 B	6 152
	5,67	388	1,25	MR 4I 64 - 14 × 160 71 B	6 159
	5,32	413	1,8	MR 4I 80 - 14 × 160 71 A	4 263
	5,32	413	2	MR 4I 81 - 14 × 160 71 A	4 263
	5,67	387	2	MR 4I 80 - 14 × 160 71 B	6 159
	6,65	330	1,18	MR 4I 63 - 11 × 140 63 C	4 210
	6,39	344	1,4	MR 4I 64 - 11 × 140 63 C	4 219
	7,35	299	1,12	MR 4I 63 - 14 × 160 71 A	4 191
	7,06	311	1,32	MR 4I 64 - 14 × 160 71 A	4 198
	7,19	306	1,32	MR 4I 63 - 14 × 160 71 B	6 125

1) Powers valid for continuous duty S1; **increase possible** for duty cycles S2 ... S10 (see ch. 1 «General specifications»); in which case M_2 increases and f_s decreases.

2) For complete designation when ordering see ch. 2.

** Mounting position **B5A** (see ch. 1.2).

11 - Selection tables (helical gearmotors)

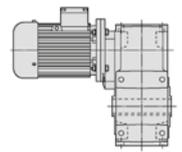

P_1 kW	n_2 min ⁻¹	M_2 N m	f_s		i		
1)				2)			
0,25	6,89	319	1,6	MR 4l 64 - 14 × 160	71 B	6	131
	6,64	331	2,5	MR 4l 80 - 14 × 160	71 A	4	211
	8,1	271	1,5	MR 4l 63 - 11 × 140	63 C	4	173
	7,76	283	1,8	MR 4l 64 - 11 × 140	63 C	4	180
	9,18	239	1,6	MR 4l 63 - 14 × 160	71 A	4	152
	8,81	249	1,9	MR 4l 64 - 14 × 160	71 A	4	159
	8,83	249	3,15	MR 4l 80 - 14 × 160	71 A	4	159
	9,11	246	2,36	MR 3l 80 - 14 × 160	71 B	6	98,8
	9,11	246	2,8	MR 3l 81 - 14 × 160	71 B	6	98,8
	9,81	224	1,8	MR 4l 63 - 11 × 140	63 C	4	143
	9,42	233	2,12	MR 4l 64 - 11 × 140	63 C	4	149
	11,2	197	2	MR 4l 63 - 14 × 160	71 A	4	125
	10,7	205	2,5	MR 4l 64 - 14 × 160	71 A	4	131
	10,9	206	2,8	MR 3l 80 - 14 × 160	71 B	6	82,7
	10,9	206	3,15	MR 3l 81 - 14 × 160	71 B	6	82,7
	11,9	184	2,12	MR 4l 63 - 11 × 140	63 C	4	117
	11,4	192	2,65	MR 4l 64 - 11 × 140	63 C	4	122
	14,7	152	1,8	MR 3l 63 - 14 × 160	71 B	6	61,1
	19,5	115	1,18	MR 3l 50 - 14 × 160	71 B	6	46,2
	16,6	135	2	MR 3l 63 - 11 × 140	63 C	4	84,3
	18,4	122	2,65	MR 3l 63 - 14 × 160	71 B	6	48,9
	22,1	101	1,32	MR 3l 50 - 11 × 140	63 C	4	63,2
	23,7	95	1,6	MR 3l 50 - 14 × 160	71 B	6	38
	20,8	108	3	MR 3l 63 - 11 × 140	63 C	4	67,5
	22,9	98	2,8	MR 3l 63 - 14 × 160	71 A	4	61,1
	26,3	85	1	MR 3l 40 - 11 × 140	63 C	4	53,2
	26,9	83	1,8	MR 3l 50 - 11 × 140	63 C	4	52
	30,3	74	1,8	MR 3l 50 - 14 × 160	71 A	4	46,2
	29,1	77	2,36	MR 3l 50 - 14 × 160	71 B	6	30,9
	28,6	78	4	MR 3l 63 - 14 × 160	71 A	4	48,9
	31,9	70	1,4	MR 3l 40 - 11 × 140	63 C	4	43,9
	36,2	62	1,12	MR 3l 40 - 11 × 140	63 C	4	38,7
	33,7	68	1	MR 2l 40 - 14 × 140	71 B	**	26,7
	33,1	68	2,65	MR 3l 50 - 11 × 140	63 C	4	42,4
	36,8	61	2,5	MR 3l 50 - 14 × 160	71 A	4	38
	36,9	62	2,12	MR 2l 50 - 14 × 160	71 B	6	24,4
	43,7	51	1,6	MR 3l 40 - 11 × 140	63 C	4	32
	40,7	56	1,5	MR 2l 40 - 14 × 140	71 B	**	22,1
	39,7	57	3,55	MR 3l 50 - 11 × 140	63 C	4	35,3
	45,2	49,6	3,55	MR 3l 50 - 14 × 160	71 A	4	30,9
	44,8	51	3	MR 2l 50 - 14 × 160	71 B	6	20,1
	53,1	42,3	2,24	MR 3l 40 - 11 × 140	63 C	4	26,4
	52,4	43,7	1,5	MR 2l 40 - 11 × 140	63 C	4	26,7
	49,4	46,4	2,12	MR 2l 40 - 14 × 140	71 B	**	18,2
	60,2	37,3	4,75	MR 3l 50 - 14 × 160	71 A	4	23,3
57,4	40	3,15	MR 2l 50 - 11 × 140	63 C	4	24,4	
57,4	40	3,15	MR 2l 50 - 14 × 160	71 A	4	24,4	
68,5	32,7	2,8	MR 3l 40 - 11 × 140	63 C	4	20,4	
63,3	36,2	2,24	MR 2l 40 - 11 × 140	63 C	4	22,1	
72,3	31,1	6,3	MR 3l 50 - 14 × 160	71 A	4	19,4	
69,7	32,9	4,5	MR 2l 50 - 11 × 140	63 C	4	20,1	
69,7	32,9	4,5	MR 2l 50 - 14 × 160	71 A	4	20,1	
76,9	29,8	3,15	MR 2l 40 - 11 × 140	63 C	4	18,2	
87,2	26,3	2,5	MR 2l 40 - 11 × 140	63 C	4	16,1	
85,6	26,8	6,7	MR 2l 50 - 11 × 140	63 C	4	16,3	
85,6	26,8	6,7	MR 2l 50 - 14 × 160	71 A	4	16,3	
105	21,8	3,75	MR 2l 40 - 11 × 140	63 C	4	13,3	
128	17,9	5	MR 2l 40 - 11 × 140	63 C	4	11	
165	13,9	6	MR 2l 40 - 11 × 140	63 C	4	8,48	
208	11	5	MR 2l 40 - 11 × 140	63 C	4	6,75	
0,37	2,58	1259	1,06	MR 4l 100 - 19 × 200	80 A	6	349
	3,14	1036	1,5	MR 4l 100 - 19 × 200	80 A	6	287
	3,75	867	1,8	MR 4l 100 - 19 × 200	80 A	6	240

P_1 kW	n_2 min ⁻¹	M_2 N m	f_s		i		
1)				2)			
0,37	4,45	730	1	MR 4l 80 - 14 × 160	71 B	4	314
	4,45	730	1,12	MR 4l 81 - 14 × 160	71 B	4	314
	4,27	762	1,12	MR 4l 80 - 14 × 160	71 C	6	211
	4,27	762	1,25	MR 4l 81 - 14 × 160	71 C	6	211
	4,29	759	1,12	MR 4l 81 - 19 × 200	80 A	6	210
	4,6	706	2,5	MR 4l 100 - 19 × 200	80 A	6	196
	5,32	611	1,18	MR 4l 80 - 14 × 160	71 B	4	263
	5,32	611	1,4	MR 4l 81 - 14 × 160	71 B	4	263
	5,67	573	1,4	MR 4l 80 - 14 × 160	71 C	6	159
	5,67	573	1,7	MR 4l 81 - 14 × 160	71 C	6	159
	5,35	608	1,4	MR 4l 80 - 19 × 200	80 A	6	168
	5,35	608	1,6	MR 4l 81 - 19 × 200	80 A	6	168
	5,53	588	3	MR 4l 100 - 19 × 200	80 A	6	163
	6,89	472	1,06	MR 4l 64 - 14 × 160	71 C	6	131
	6,64	490	1,7	MR 4l 80 - 14 × 160	71 B	4	211
	6,64	490	2	MR 4l 81 - 14 × 160	71 B	4	211
	9,18	354	1,12	MR 4l 63 - 14 × 160	71 B	4	152
	8,81	369	1,32	MR 4l 64 - 14 × 160	71 B	4	159
	8,83	368	2,12	MR 4l 80 - 14 × 160	71 B	4	159
	8,83	368	2,65	MR 4l 81 - 14 × 160	71 B	4	159
	9,11	365	1,6	MR 3l 80 - 14 × 160	71 C	6	98,8
	9,11	365	1,9	MR 3l 81 - 14 × 160	71 C	6	98,8
	11,2	291	1,32	MR 4l 63 - 14 × 160	71 B	4	125
	10,7	303	1,6	MR 4l 64 - 14 × 160	71 B	4	131
	10,1	322	2,65	MR 4l 80 - 14 × 160	71 B	4	139
	10,9	305	1,9	MR 3l 80 - 14 × 160	71 C	6	82,7
	10,9	305	2,24	MR 3l 81 - 14 × 160	71 C	6	82,7
	13,5	240	1,6	MR 4l 63 - 14 × 160	71 B	4	103
	13	250	1,9	MR 4l 64 - 14 × 160	71 B	4	108
	14,7	225	1,18	MR 3l 63 - 14 × 160	71 C	6	61,1
	13,4	242	3,55	MR 4l 80 - 14 × 160	71 B	4	104
	14,2	234	2,5	MR 3l 80 - 14 × 160	71 B	4	98,8
	16,5	197	2	MR 4l 63 - 14 × 160	71 B	4	84,9
	16,6	200	1,32	MR 3l 63 - 11 × 140	71 B	* 4	84,3
	16	208	1,7	MR 3l 64 - 11 × 140	71 B	* 4	87,7
	18,4	180	1,7	MR 3l 63 - 14 × 160	71 C	6	48,9
	18,4	181	1,5	MR 3l 63 - 19 × 200	80 A	6	48,9
	17,7	188	1,9	MR 3l 64 - 19 × 200	80 A	6	50,9
	16,9	196	3	MR 3l 80 - 14 × 160	71 B	4	82,7
	22,1	150	0,9	MR 3l 50 - 11 × 140	71 B	* 4	63,2
	23,7	140	1,12	MR 3l 50 - 14 × 160	71 C	6	38
	20,8	160	2	MR 3l 63 - 11 × 140	71 B	* 4	67,5
	22,9	145	1,9	MR 3l 63 - 14 × 160	71 B	4	61,1
	26,9	123	1,25	MR 3l 50 - 11 × 140	71 B	* 4	52
	30,3	110	1,18	MR 3l 50 - 14 × 160	71 B	4	46,2
	29,1	114	1,6	MR 3l 50 - 14 × 160	71 C	6	30,9
	28,6	116	2,65	MR 3l 63 - 14 × 160	71 B	4	48,9
	36,8	90	1,7	MR 3l 50 - 14 × 160	71 B	4	38
	38,7	86	2,12	MR 3l 50 - 14 × 160	71 C	6	23,3
	36,9	92	1,4	MR 2l 50 - 14 × 160	71 C	6	24,4
	37,4	91	3	MR 2l 63 - 14 × 160	71 C	6	24,1
	37,4	91	3	MR 2l 63 - 19 × 200	80 A	6	24,1
40,7	83	1	MR 2l 40 - 14 × 140	71 C	** 6	22,1	
45,2	73	2,5	MR 3l 50 - 14 × 160	71 B	4	30,9	
44,8	76	2	MR 2l 50 - 14 × 160	71 C	6	20,1	
52,4	65	1,06	MR 2l 40 - 14 × 140	71 B	** 4	26,7	
49,4	69	1,4	MR 2l 40 - 14 × 140	71 C	** 6	18,2	
60,2	55	3,15	MR 3l 50 - 14 × 160	71 B	4	23,3	
57,4	59	2,12	MR 2l 50 - 14 × 160	71 B	4	24,4	
63,3	54	1,5	MR 2l 40 - 14 × 140	71 B	** 4	22,1	
72,3	46	4,25	MR 3l 50 - 14 × 160	71 B	4	19,4	
69,7	48,6	3	MR 2l 50 - 14 × 160	71 B	4	20,1	
76,9	44,1	2,12	MR 2l 40 - 14 × 140	71 B	** 4	18,2	
87,2	38,9	1,7	MR 2l 40 - 14 × 140	71 B	** 4	16,1	
85,6	39,6	4,5	MR 2l 50 - 14 × 160	71 B	4	16,3	

1) Powers valid for continuous duty S1; **increase possible** for duty cycles S2 ... S10 (see ch. 1 «General specifications»); in which case M_2 increases and f_s decreases.

2) For complete designation when ordering see ch. 2.

* Mounting position **B5R** (see ch. 1.2).

** Mounting position **B5A** (see ch. 1.2).

11 - Selection tables (helical gearmotors)

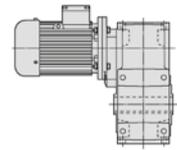

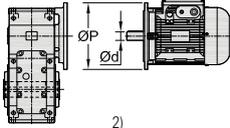
P_1 kW	n_2 min ⁻¹	M_2 N m	f_s		i
1)				2)	
0,37	105	32,2	2,5	MR 2I 40 - 14 × 140 71 B ** 4	13,3
	114	29,8	6	MR 2I 50 - 14 × 160 71 B 4	12,3
	128	26,5	3,35	MR 2I 40 - 14 × 140 71 B ** 4	11
	137	24,8	8	MR 2I 50 - 14 × 160 71 B 4	10,2
	165	20,5	4,25	MR 2I 40 - 14 × 140 71 B ** 4	8,48
208	16,3	3,35	MR 2I 40 - 14 × 140 71 B ** 4	6,75	
0,55	3,14	1540	1	MR 4I 100 - 19 × 200 80 B 6	287
	4,02	1203	1,12	MR 4I 100 - 19 × 200 80 A 4	349
	3,75	1289	1,18	MR 4I 100 - 19 × 200 80 B 6	240
	4,88	990	1,5	MR 4I 100 - 19 × 200 80 A 4	287
	5,35	903	1,06	MR 4I 81 - 19 × 200 80 B 6	168
	5,83	829	1,8	MR 4I 100 - 19 × 200 80 A 4	240
	6,64	728	1,18	MR 4I 80 - 14 × 160 71 C 4	211
	6,64	728	1,32	MR 4I 81 - 14 × 160 71 C 4	211
	6,67	725	1	MR 4I 80 - 19 × 200 80 A 4	210
	6,67	725	1,18	MR 4I 81 - 19 × 200 80 A 4	210
	7,16	675	2,65	MR 4I 100 - 19 × 200 80 A 4	196
	8,21	601	2,24	MR 3I 100 - 19 × 200 80 B 6	110
	8,83	547	1,4	MR 4I 80 - 14 × 160 71 C 4	159
	8,83	547	1,8	MR 4I 81 - 14 × 160 71 C 4	159
	8,32	581	1,4	MR 4I 80 - 19 × 200 80 A 4	168
	8,32	581	1,7	MR 4I 81 - 19 × 200 80 A 4	168
	8,6	562	3,15	MR 4I 100 - 19 × 200 80 A 4	163
	9,98	494	3	MR 3I 100 - 19 × 200 80 B 6	90,1
	10,7	451	1,12	MR 4I 64 - 14 × 160 71 C 4	131
	10,1	478	1,8	MR 4I 80 - 14 × 160 71 C 4	139
	10,1	478	2	MR 4I 81 - 14 × 160 71 C 4	139
	11,1	437	1,8	MR 4I 80 - 19 × 200 80 A 4	127
	11,1	437	2,24	MR 4I 81 - 19 × 200 80 A 4	127
	11,2	430	4	MR 4I 100 - 19 × 200 80 A 4	124
	11,9	414	3,55	MR 3I 100 - 19 × 200 80 B 6	75,5
	13,5	357	1,12	MR 4I 63 - 14 × 160 71 C 4	103
	13	372	1,32	MR 4I 64 - 14 × 160 71 C 4	108
	12,7	382	2,24	MR 4I 80 - 19 × 200 80 A 4	111
	12,7	382	2,5	MR 4I 81 - 19 × 200 80 A 4	111
	14,2	348	1,7	MR 3I 80 - 14 × 160 71 C 4	98,8
	14,2	348	1,9	MR 3I 81 - 14 × 160 71 C 4	98,8
	16,5	293	1,32	MR 4I 63 - 14 × 160 71 C 4	84,9
	15,8	306	1,6	MR 4I 64 - 14 × 160 71 C 4	88,6
	18,4	268	1	MR 3I 63 - 19 × 200 80 B 6	48,9
	17,7	279	1,32	MR 3I 64 - 19 × 200 80 B 6	50,9
	16,8	287	3	MR 4I 80 - 19 × 200 80 A 4	83,2
	16,9	292	2	MR 3I 80 - 14 × 160 71 C 4	82,7
	16,9	292	2,24	MR 3I 81 - 14 × 160 71 C 4	82,7
	22,9	215	1,25	MR 3I 63 - 14 × 160 71 C 4	61,1
	22	224	1,6	MR 3I 64 - 14 × 160 71 C 4	63,5
	23	215	1,5	MR 3I 63 - 19 × 200 80 B 6	39,1
	22,1	224	1,8	MR 3I 64 - 19 × 200 80 B 6	40,8
	21,1	234	2,8	MR 3I 80 - 14 × 160 71 C 4	66,3
	21,2	233	2,5	MR 3I 80 - 19 × 200 80 A 4	66
	30,3	163	0,8	MR 3I 50 - 14 × 160 71 C 4	46,2
	28,6	172	1,8	MR 3I 63 - 14 × 160 71 C 4	48,9
	28,6	172	1,6	MR 3I 63 - 19 × 200 80 A 4	48,9
	27,5	179	2	MR 3I 64 - 19 × 200 80 A 4	50,9
	36,8	134	1,12	MR 3I 50 - 14 × 160 71 C 4	38
	36,9	137	0,95	MR 2I 50 - 19 × 160 80 B ** 6	24,4
34,9	142	2,36	MR 3I 63 - 14 × 160 71 C 4	40,1	
35,8	138	2,24	MR 3I 63 - 19 × 200 80 A 4	39,1	
37,4	135	2	MR 2I 63 - 19 × 200 80 B 6	24,1	
45,2	109	1,6	MR 3I 50 - 14 × 160 71 C 4	30,9	
44,8	112	1,32	MR 2I 50 - 19 × 160 80 B ** 6	20,1	
43,6	113	3	MR 3I 63 - 19 × 200 80 A 4	32,1	
46,7	108	3	MR 2I 63 - 19 × 200 80 B 6	19,3	
60,2	82	2,12	MR 3I 50 - 14 × 160 71 C 4	23,3	
57,4	88	1,5	MR 2I 50 - 14 × 160 71 C 4	24,4	
55,1	92	1,9	MR 2I 50 - 19 × 160 80 B ** 6	16,3	
58,1	87	3,15	MR 2I 63 - 14 × 160 71 C 4	24,1	
58,1	87	3,15	MR 2I 63 - 19 × 200 80 A 4	24,1	

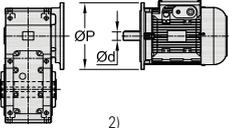
P_1 kW	n_2 min ⁻¹	M_2 N m	f_s		i
1)				2)	
0,55	63,3	80	1	MR 2I 40 - 14 × 140 71 C ** 4	22,1
	72,3	68	2,8	MR 3I 50 - 14 × 160 71 C 4	19,4
	69,7	72	2,12	MR 2I 50 - 14 × 160 71 C 4	20,1
	76,9	66	1,4	MR 2I 40 - 14 × 140 71 C ** 4	18,2
	87,2	58	1,12	MR 2I 40 - 14 × 140 71 C ** 4	16,1
	85,6	59	3	MR 2I 50 - 14 × 160 71 C 4	16,3
	105	47,9	1,7	MR 2I 40 - 14 × 140 71 C ** 4	13,3
	114	44,3	4	MR 2I 50 - 14 × 160 71 C 4	12,3
	128	39,4	2,24	MR 2I 40 - 14 × 140 71 C ** 4	11
	137	36,9	5,3	MR 2I 50 - 14 × 160 71 C 4	10,2
	165	30,5	2,8	MR 2I 40 - 14 × 140 71 C ** 4	8,48
	175	28,8	6	MR 2I 50 - 14 × 160 71 C 4	8,01
	208	24,3	2,24	MR 2I 40 - 14 × 140 71 C ** 4	6,75
	218	23,1	6,3	MR 2I 50 - 14 × 160 71 C 4	6,42
	0,75	3,1	2126	1,4	MR 4I 125 - 24 × 200 90 S 6
3,83		1723	1,8	MR 4I 125 - 24 × 200 90 S 6	235
4,88		1350	1,12	MR 4I 100 - 19 × 200 80 B 4	287
4,6		1432	1,25	MR 4I 100 - 19 × 200 80 C 6	196
4,7		1403	1,06	MR 4I 100 - 24 × 200 90 S 6	192
4,78		1378	2,5	MR 4I 125 - 24 × 200 90 S 6	188
5,83		1130	1,32	MR 4I 100 - 19 × 200 80 B 4	240
5,53		1192	1,5	MR 4I 100 - 19 × 200 80 C 6	163
5,77		1142	1,5	MR 4I 100 - 24 × 200 90 S 6	156
5,82		1132	3,15	MR 4I 125 - 24 × 200 90 S 6	155
7,11		926	1,06	MR 4I 81 - 19 × 200 80 C 6	127
7,16		920	1,9	MR 4I 100 - 19 × 200 80 B 4	196
8,21		820	1,7	MR 3I 100 - 19 × 200 80 C 6	110
7,05		934	3,75	MR 4I 125 - 24 × 200 90 S 6	128
8,32		792	1,06	MR 4I 80 - 19 × 200 80 B 4	168
8,32		792	1,25	MR 4I 81 - 19 × 200 80 B 4	168
8,6		766	2,24	MR 4I 100 - 19 × 200 80 B 4	163
9,98		674	2,24	MR 3I 100 - 19 × 200 80 C 6	90,1
11,1		596	1,32	MR 4I 80 - 19 × 200 80 B 4	127
11,1		596	1,6	MR 4I 81 - 19 × 200 80 B 4	127
11,2		586	3	MR 4I 100 - 19 × 200 80 B 4	124
12,8		527	2,5	MR 3I 100 - 19 × 200 80 B 4	110
12,7		520	1,6	MR 4I 80 - 19 × 200 80 B 4	111
12,7		520	1,9	MR 4I 81 - 19 × 200 80 B 4	111
14,2		475	1,25	MR 3I 80 - 14 × 160 80 B *	98,8
14,2		475	1,4	MR 3I 81 - 14 × 160 80 B *	98,8
13,6		494	1,18	MR 3I 80 - 19 × 200 80 C 6	66
13,6		494	1,32	MR 3I 81 - 19 × 200 80 C 6	66
15,5		433	3,15	MR 3I 100 - 19 × 200 80 B 4	90,1
14,9		450	3,15	MR 3I 100 - 24 × 200 90 S 6	60,2
17,7		381	0,95	MR 3I 64 - 19 × 200 80 C 6	50,9
16,8		391	2,12	MR 4I 80 - 19 × 200 80 B 4	83,2
16,8		391	2,5	MR 4I 81 - 19 × 200 80 B 4	83,2
16,9		398	1,5	MR 3I 80 - 14 × 160 80 B *	82,7
16,9		398	1,7	MR 3I 81 - 14 × 160 80 B *	82,7
17	396	1,7	MR 3I 80 - 19 × 200 80 C 6	52,9	
17	396	2	MR 3I 81 - 19 × 200 80 C 6	52,9	
17,3	389	1,5	MR 3I 80 - 24 × 200 90 S 6	52	
17,3	389	1,7	MR 3I 81 - 24 × 200 90 S 6	52	
18,5	363	3,75	MR 3I 100 - 19 × 200 80 B 4	75,5	
22,9	294	0,95	MR 3I 63 - 14 × 160 80 B *	61,1	
22	306	1,18	MR 3I 64 - 14 × 160 80 B *	63,5	
23	293	1,06	MR 3I 63 - 19 × 200 80 C 6	39,1	
22,1	305	1,32	MR 3I 64 - 19 × 200 80 C 6	40,8	
21,1	319	2,12	MR 3I 80 - 14 × 160 80 B *	66,3	
21,2	317	1,8	MR 3I 80 - 19 × 200 80 B 4	66	
21,2	317	2,12	MR 3I 81 - 19 × 200 80 B 4	66	
28,6	235	1,32	MR 3I 63 - 14 × 160 80 B *	48,9	
28,6	235	1,18	MR 3I 63 - 19 × 200 80 B 4	48,9	
27,5	245	1,6	MR 3I 64 - 14 × 160 80 B *	50,9	
27,5	245	1,5	MR 3I 64 - 19 × 200 80 B 4	50,9	
28	240	1,4	MR 3I 63 - 19 × 200 80 C 6	32,1	
26,8	251	1,8	MR 3I 64 - 19 × 200 80 C 6	33,5	
26,5	254	2,65	MR 3I 80 - 19 × 200 80 B 4	52,9	

1) Powers valid for continuous duty S1; **increase possible** for duty cycles S2 ... S10 (see ch. 1 «General specifications»); in which case M_2 increases and f_s decreases.

2) For complete designation when ordering see ch. 2.

* Mounting position **B5R** (see ch. 1.2).

** Mounting position **B5A** (see ch. 1.2).

11 - Selection tables (helical gearmotors)

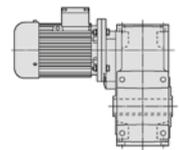

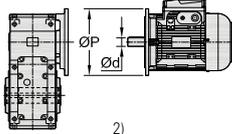
P_1 kW	n_2 min ⁻¹	M_2 N m	f_s		i	
1)				2)		
0,75	35,8	188	1,7	MR 3I 63 - 19 × 200 80 B	4 39,1	
	34,3	196	2	MR 3I 64 - 19 × 200 80 B	4 40,8	
	32,6	207	1,9	MR 3I 64 - 19 × 200 80 C	6 27,6	
	37,4	184	1,5	MR 2I 63 - 19 × 200 80 C	6 24,1	
	35,9	191	1,9	MR 2I 64 - 19 × 200 80 C	6 25,1	
	37,4	184	1,5	MR 2I 63 - 24 × 200 90 S	6 24,1	
	35,9	191	1,9	MR 2I 64 - 24 × 200 90 S	6 25,1	
	44,8	153	1	MR 2I 50 - 19 × 160 80 C	** 6 20,1	
	43,6	155	2,12	MR 3I 63 - 19 × 200 80 B	4 32,1	
	46,7	147	2,12	MR 2I 63 - 19 × 200 80 C	6 19,3	
	46,7	147	2,12	MR 2I 63 - 24 × 200 90 S	6 19,3	
	57,4	120	1,06	MR 2I 50 - 19 × 160 80 B	** 4 24,4	
	55,1	125	1,4	MR 2I 50 - 19 × 160 80 C	** 6 16,3	
	52,8	128	2,5	MR 3I 63 - 19 × 200 80 B	4 26,5	
	58,1	118	2,24	MR 2I 63 - 19 × 200 80 B	4 24,1	
	69,7	99	1,5	MR 2I 50 - 19 × 160 80 B	** 4 20,1	
	73,2	94	1,9	MR 2I 50 - 19 × 160 80 C	** 6 12,3	
	64,2	105	3,15	MR 3I 63 - 19 × 200 80 B	4 21,8	
	72,6	95	3,35	MR 2I 63 - 19 × 200 80 B	4 19,3	
	76,9	89	1,06	MR 2I 40 - 14 × 140 71 D	** 4 18,2	
	85,6	80	2,24	MR 2I 50 - 19 × 160 80 B	** 4 16,3	
	105	65	1,25	MR 2I 40 - 14 × 140 71 D	** 4 13,3	
	114	60	2,8	MR 2I 50 - 19 × 160 80 B	** 4 12,3	
	128	54	1,7	MR 2I 40 - 14 × 140 71 D	** 4 11	
	137	50	3,75	MR 2I 50 - 19 × 160 80 B	** 4 10,2	
	165	41,6	2	MR 2I 40 - 14 × 140 71 D	** 4 8,48	
	175	39,3	4,25	MR 2I 50 - 19 × 160 80 B	** 4 8,01	
	208	33,1	1,6	MR 2I 40 - 14 × 140 71 D	** 4 6,75	
	218	31,5	4,5	MR 2I 50 - 19 × 160 80 B	** 4 6,42	
	1,1	3,1	3118	0,95	MR 4I 125 - 24 × 200 90 L	6 290
		3,83	2526	1,18	MR 4I 125 - 24 × 200 90 L	6 235
		4,82	2005	1,5	MR 4I 125 - 24 × 200 90 S	4 290
		4,78	2021	1,7	MR 4I 125 - 24 × 200 90 L	6 188
		5,77	1675	1,06	MR 4I 100 - 24 × 200 90 L	6 156
		5,95	1624	1,9	MR 4I 125 - 24 × 200 90 S	4 235
		5,82	1660	2,12	MR 4I 125 - 24 × 200 90 L	6 155
		7,16	1350	1,32	MR 4I 100 - 19 × 200 80 C	4 196
		7,31	1323	1,18	MR 4I 100 - 24 × 200 90 S	4 192
		7,44	1299	2,65	MR 4I 125 - 24 × 200 90 S	4 188
		8,6	1124	1,6	MR 4I 100 - 19 × 200 80 C	4 163
8,97		1077	1,6	MR 4I 100 - 24 × 200 90 S	4 156	
9,06		1067	3,35	MR 4I 125 - 24 × 200 90 S	4 155	
9,69		1020	2,8	MR 3I 125 - 24 × 200 90 L	6 92,9	
11,1		874	1,12	MR 4I 81 - 19 × 200 80 C	4 127	
11,2		859	2	MR 4I 100 - 19 × 200 80 C	4 124	
10,8		897	2	MR 4I 100 - 24 × 200 90 S	4 130	
12,8		773	1,7	MR 3I 100 - 19 × 200 80 C	4 110	
12,3		803	1,6	MR 3I 100 - 24 × 200 90 L	6 73,2	
11		881	4	MR 4I 125 - 24 × 200 90 S	4 128	
12		826	3,35	MR 3I 125 - 24 × 200 90 L	6 75,3	
12,7		763	1,12	MR 4I 80 - 19 × 200 80 C	4 111	
12,7		763	1,25	MR 4I 81 - 19 × 200 80 C	4 111	
14,1		685	2,5	MR 4I 100 - 24 × 200 90 S	4 99,3	
15,5		636	2,24	MR 3I 100 - 19 × 200 80 C	4 90,1	
14,9		661	2,12	MR 3I 100 - 24 × 200 90 L	6 60,2	
16,8		574	1,5	MR 4I 80 - 19 × 200 80 C	4 83,2	
16,8		574	1,7	MR 4I 81 - 19 × 200 80 C	4 83,2	
17,3		571	1	MR 3I 80 - 24 × 200 90 L	6 52	
17,3		571	1,18	MR 3I 81 - 24 × 200 90 L	6 52	
16,9		571	3	MR 4I 100 - 24 × 200 90 S	4 82,7	
18,5		532	2,65	MR 3I 100 - 19 × 200 80 C	4 75,5	
19,1		516	2,5	MR 3I 100 - 24 × 200 90 S	4 73,2	
21,2		466	1,25	MR 3I 80 - 19 × 200 80 C	4 66	
21,2		466	1,4	MR 3I 81 - 19 × 200 80 C	4 66	
21,6		457	1,5	MR 3I 80 - 24 × 200 90 L	6 41,7	
21,6		457	1,7	MR 3I 81 - 24 × 200 90 L	6 41,7	
22,8		433	3,75	MR 3I 100 - 19 × 200 80 C	4 61,5	
23,3		425	3,35	MR 3I 100 - 24 × 200 90 S	4 60,2	

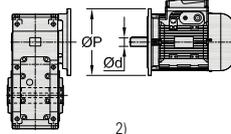
P_1 kW	n_2 min ⁻¹	M_2 N m	f_s		i
1)				2)	
1,1	28,6	345	0,8	MR 3I 63 - 19 × 200 80 C	4 48,9
	27,5	359	1	MR 3I 64 - 19 × 200 80 C	4 50,9
	26,5	373	1,8	MR 3I 80 - 19 × 200 80 C	4 52,9
	26,5	373	2,12	MR 3I 81 - 19 × 200 80 C	4 52,9
	26,9	367	1,6	MR 3I 80 - 24 × 200 90 S	4 52
	26,9	367	1,8	MR 3I 81 - 24 × 200 90 S	4 52
	35,8	276	1,12	MR 3I 63 - 19 × 200 80 C	4 39,1
	34,3	287	1,32	MR 3I 64 - 19 × 200 80 C	4 40,8
	37,4	270	1	MR 2I 63 - 24 × 200 90 L	6 24,1
	35,9	281	1,25	MR 2I 64 - 24 × 200 90 L	6 25,1
	35,2	281	2,65	MR 3I 80 - 19 × 200 80 C	4 39,8
	33,6	294	2,24	MR 3I 80 - 24 × 200 90 S	4 41,7
	34,6	291	2	MR 2I 80 - 24 × 200 90 L	6 26
	34,6	291	2,24	MR 2I 81 - 24 × 200 90 L	6 26
	43,6	227	1,5	MR 3I 63 - 19 × 200 80 C	4 32,1
	41,7	237	1,8	MR 3I 64 - 19 × 200 80 C	4 33,5
	46,7	216	1,5	MR 2I 63 - 24 × 200 90 L	6 19,3
	44,8	225	1,7	MR 2I 64 - 24 × 200 90 L	6 20,1
	44,7	221	3,35	MR 3I 80 - 24 × 200 90 S	4 31,3
	43,2	233	2,8	MR 2I 80 - 24 × 200 90 L	6 20,8
	52,8	187	1,7	MR 3I 63 - 19 × 200 80 C	4 26,5
	50,7	195	2	MR 3I 64 - 19 × 200 80 C	4 27,6
	58,1	174	1,5	MR 2I 63 - 19 × 200 80 C	4 24,1
	55,9	180	1,9	MR 2I 64 - 19 × 200 80 C	4 25,1
	58,1	174	1,5	MR 2I 63 - 24 × 200 90 S	4 24,1
	55,9	180	1,9	MR 2I 64 - 24 × 200 90 S	4 25,1
	56,8	177	1,9	MR 2I 63 - 24 × 200 90 L	6 15,8
	54,5	185	2,36	MR 2I 64 - 24 × 200 90 L	6 16,5
	53,8	187	3	MR 2I 80 - 24 × 200 90 S	4 26
	69,7	145	1,06	MR 2I 50 - 19 × 160 80 C	** 4 20,1
	64,2	154	2,12	MR 3I 63 - 19 × 200 80 C	4 21,8
	72,6	139	2,24	MR 2I 63 - 19 × 200 80 C	4 19,3
	72,6	139	2,24	MR 2I 63 - 24 × 200 90 S	4 19,3
	85,6	118	1,5	MR 2I 50 - 19 × 160 80 C	** 4 16,3
	88,4	114	2,8	MR 2I 63 - 19 × 200 80 C	4 15,8
	88,4	114	2,8	MR 2I 63 - 24 × 200 90 S	4 15,8
	114	89	2	MR 2I 50 - 19 × 160 80 C	** 4 12,3
	107	94	3,35	MR 2I 63 - 19 × 200 80 C	4 13,1
	107	94	3,35	MR 2I 63 - 24 × 200 90 S	4 13,1
	137	74	2,65	MR 2I 50 - 19 × 160 80 C	** 4 10,2
130	77	4,25	MR 2I 63 - 19 × 200 80 C	4 10,7	
130	77	4,25	MR 2I 63 - 24 × 200 90 S	4 10,7	
175	58	3	MR 2I 50 - 19 × 160 80 C	** 4 8,01	
169	60	6	MR 2I 63 - 19 × 200 80 C	4 8,26	
169	60	6	MR 2I 63 - 24 × 200 90 S	4 8,26	
218	46,2	3,15	MR 2I 50 - 19 × 160 80 C	** 4 6,42	
214	47,1	6,3	MR 2I 63 - 19 × 200 80 C	4 6,53	
214	47,1	6,3	MR 2I 63 - 24 × 200 90 S	4 6,53	
1,5	4,82	2734	1,12	MR 4I 125 - 24 × 200 90 L	4 290
	4,78	2756	1,25	MR 4I 125 - 24 × 200 90 LC	6 188
	4,71	2795	1,06	MR 4I 125 - 28 × 250 100 LA	6 191
	5,95	2215	1,4	MR 4I 125 - 24 × 200 90 L	4 235
	5,82	2264	1,5	MR 4I 125 - 24 × 200 90 LC	6 155
	5,89	2236	1,6	MR 4I 125 - 28 × 250 100 LA	6 153
	7,44	1772	2	MR 4I 125 - 24 × 200 90 L	4 188
	7,34	1835	2,24	MR 3I 140 - 28 × 250 100 LA	6 123
	8,97	1468	1,18	MR 4I 100 - 24 × 200 90 L	4 156
	9,06	1455	2,36	MR 4I 125 - 24 × 200 90 L	4 155
	9,69	1390	2	MR 3I 125 - 24 × 200 90 LC	6 92,9
	9	1496	3,35	MR 3I 140 - 28 × 250 100 LA	6 100
	10,1	1337	3,55	MR 3I 140 - 28 × 250 100 LA	6 89,4
	10,8	1223	1,4	MR 4I 100 - 24 × 200 90 L	4 130
	12,8	1054	1,18	MR 3I 100 - 19 × 200 90 L	* 4 110
	12,3	1095	1,18	MR 3I 100 - 24 × 200 90 LC	6 73,2
11	1201	3	MR 4I 125 - 24 × 200 90 L	4 128	
12	1126	2,36	MR 3I 125 - 24 × 200 90 LC	6 75,3	
12	1126	2,36	MR 3I 125 - 28 × 250 100 LA	6 75,3	

1) Powers valid for continuous duty S1; **increase possible** for duty cycles S2 ... S10 (see ch. 1 «General specifications»); in which case M_2 increases and f_s decreases.
 2) For complete designation when ordering see ch. 2.

* Mounting position **B5R** (see ch. 1.2).
 ** Mounting position **B5A** (see ch. 1.2).

11 - Selection tables (helical gearmotors)

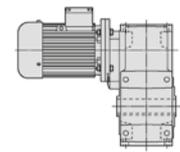

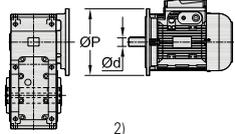
P_1 kW	n_2 min ⁻¹	M_2 N m	f_s		i	
1)				2)		
1,5	14,1	935	1,9	MR 4I 100 - 24 × 200 90 L	4	99,3
	15,5	867	1,6	MR 3I 100 - 19 × 200 90 L	* 4	90,1
	14,9	901	1,6	MR 3I 100 - 24 × 200 90 LC	6	60,2
	15,6	863	1,5	MR 3I 100 - 28 × 250 100 LA	6	57,7
	15,1	894	3	MR 3I 125 - 24 × 200 90 L	4	92,9
	17,3	778	0,85	MR 3I 81 - 24 × 200 90 LC	6	52
	16,9	778	2,24	MR 4I 100 - 24 × 200 90 L	4	82,7
	18,5	726	1,9	MR 3I 100 - 19 × 200 90 L	* 4	75,5
	19,1	704	1,8	MR 3I 100 - 24 × 200 90 L	4	73,2
	18,4	734	2,24	MR 3I 100 - 24 × 200 90 LC	6	49
	19	710	2	MR 3I 100 - 28 × 250 100 LA	6	47,4
	18,6	724	3,75	MR 3I 125 - 24 × 200 90 L	4	75,3
	21,2	635	0,9	MR 3I 80 - 19 × 200 90 L	* 4	66
	21,2	635	1,06	MR 3I 81 - 19 × 200 90 L	* 4	66
	21,6	623	1,06	MR 3I 80 - 24 × 200 90 LC	6	41,7
	21,6	623	1,25	MR 3I 81 - 24 × 200 90 LC	6	41,7
	23,3	579	2,36	MR 3I 100 - 24 × 200 90 L	4	60,2
	26,5	509	1,32	MR 3I 80 - 19 × 200 90 L	* 4	52,9
	26,9	500	1,18	MR 3I 80 - 24 × 200 90 L	4	52
	26,5	509	1,5	MR 3I 81 - 19 × 200 90 L	* 4	52,9
	26,9	500	1,32	MR 3I 81 - 24 × 200 90 L	4	52
	28,7	469	1,6	MR 3I 80 - 24 × 200 90 LC	6	31,3
	28,7	469	1,9	MR 3I 81 - 24 × 200 90 LC	6	31,3
	28,6	472	3,35	MR 3I 100 - 24 × 200 90 L	4	49
	31,2	441	2,8	MR 2I 100 - 24 × 200 90 LC	6	28,8
	31,2	441	2,8	MR 2I 100 - 28 × 250 100 LA	6	28,8
	35,8	376	0,85	MR 3I 63 - 19 × 200 90 L	* 4	39,1
	34,3	392	1	MR 3I 64 - 19 × 200 90 L	* 4	40,8
	35,9	383	0,95	MR 2I 64 - 24 × 200 90 LC	6	25,1
	33,6	401	1,7	MR 3I 80 - 24 × 200 90 L	4	41,7
	33,6	401	1,9	MR 3I 81 - 24 × 200 90 L	4	41,7
	34,6	397	1,5	MR 2I 80 - 24 × 200 90 LC	6	26
	34,6	397	1,7	MR 2I 81 - 24 × 200 90 LC	6	26
	34,6	397	1,5	MR 2I 80 - 28 × 250 100 LA	6	26
	34,6	397	1,7	MR 2I 81 - 28 × 250 100 LA	6	26
	34,3	393	4,5	MR 3I 100 - 24 × 200 90 L	4	40,8
	37,9	362	3,75	MR 2I 100 - 28 × 250 100 LA	6	23,7
	43,6	309	1,06	MR 3I 63 - 19 × 200 90 L	* 4	32,1
	41,7	323	1,32	MR 3I 64 - 19 × 200 90 L	* 4	33,5
	46,7	294	1,06	MR 2I 63 - 24 × 200 90 LC	6	19,3
	44,8	307	1,25	MR 2I 64 - 24 × 200 90 LC	6	20,1
	44,7	301	2,5	MR 3I 80 - 24 × 200 90 L	4	31,3
	43,2	318	2,12	MR 2I 80 - 24 × 200 90 LC	6	20,8
	43,2	318	2,12	MR 2I 80 - 28 × 250 100 LA	6	20,8
	52,8	255	1,25	MR 3I 63 - 19 × 200 90 L	* 4	26,5
	50,7	266	1,4	MR 3I 64 - 19 × 200 90 L	* 4	27,6
	58,1	237	1,12	MR 2I 63 - 24 × 200 90 L	4	24,1
	55,9	246	1,4	MR 2I 64 - 24 × 200 90 L	4	25,1
	56,8	242	1,4	MR 2I 63 - 24 × 200 90 LC	6	15,8
	54,5	252	1,7	MR 2I 64 - 24 × 200 90 LC	6	16,5
51,1	263	2,5	MR 3I 80 - 24 × 200 90 L	4	27,4	
53,8	255	2,24	MR 2I 80 - 24 × 200 90 L	4	26	
64,2	210	1,6	MR 3I 63 - 19 × 200 90 L	* 4	21,8	
61,6	219	2	MR 3I 64 - 19 × 200 90 L	* 4	22,7	
72,6	189	1,6	MR 2I 63 - 24 × 200 90 L	4	19,3	
69,7	197	1,9	MR 2I 64 - 24 × 200 90 L	4	20,1	
68	198	3,75	MR 3I 80 - 24 × 200 90 L	4	20,6	
67,2	205	3,15	MR 2I 80 - 24 × 200 90 L	4	20,8	
88,4	156	2,12	MR 2I 63 - 24 × 200 90 L	4	15,8	
89,4	154	4,25	MR 2I 80 - 24 × 200 90 L	4	15,7	
107	128	2,36	MR 2I 63 - 24 × 200 90 L	4	13,1	
102	134	4,75	MR 2I 80 - 24 × 200 90 L	4	13,7	
130	105	3,15	MR 2I 63 - 24 × 200 90 L	4	10,7	
169	81	4,5	MR 2I 63 - 24 × 200 90 L	4	8,26	
214	64	4,75	MR 2I 63 - 24 × 200 90 L	4	6,53	
1,85	5,95	2731	1,12	MR 4I 125 - 24 × 200 90 LB	4	235
	5,89	2758	1,25	MR 4I 125 - 28 × 250 100 LB	6	153

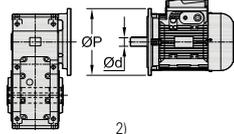
P_1 kW	n_2 min ⁻¹	M_2 N m	f_s		i	
1)				2)		
1,85	7,44	2185	1,6	MR 4I 125 - 24 × 200 90 LB	4	188
	7,34	2263	1,8	MR 3I 140 - 28 × 250 100 LB	6	123
	7,06	2354	2,8	MR 3I 160 - 28 × 250 100 LB	6	128
	9,06	1795	1,9	MR 4I 125 - 24 × 200 90 LB	4	155
	9	1845	2,8	MR 3I 140 - 28 × 250 100 LB	6	100
	10,1	1649	3	MR 3I 140 - 28 × 250 100 LB	6	89,4
	10,8	1508	1,18	MR 4I 100 - 24 × 200 90 LB	4	130
	12,8	1300	1	MR 3I 100 - 19 × 200 90 LB	* 4	110
	11	1481	2,36	MR 4I 125 - 24 × 200 90 LB	4	128
	12	1389	2	MR 3I 125 - 28 × 250 100 LB	6	75,3
	11,1	1503	3,35	MR 3I 140 - 28 × 250 100 LB	6	81,4
	14,1	1153	1,5	MR 4I 100 - 24 × 200 90 LB	4	99,3
	15,5	1069	1,32	MR 3I 100 - 19 × 200 90 LB	* 4	90,1
	15,6	1064	1,18	MR 3I 100 - 28 × 250 100 LB	6	57,7
	15,1	1102	2,36	MR 3I 125 - 24 × 200 90 LB	4	92,9
	14,7	1127	2,36	MR 3I 125 - 28 × 250 100 LB	6	61,1
	16,9	960	1,8	MR 4I 100 - 24 × 200 90 LB	4	82,7
	18,5	895	1,6	MR 3I 100 - 19 × 200 90 LB	* 4	75,5
	19,1	868	1,5	MR 3I 100 - 24 × 200 90 LB	4	73,2
	19	875	1,6	MR 3I 100 - 28 × 250 100 LB	6	47,4
	18,6	893	3	MR 3I 125 - 24 × 200 90 LB	4	75,3
	18,4	902	3,55	MR 3I 125 - 28 × 250 100 LB	6	48,9
	21,2	783	0,85	MR 3I 81 - 19 × 200 90 LB	* 4	66
	23,3	714	1,9	MR 3I 100 - 24 × 200 90 LB	4	60,2
	23,3	713	2,24	MR 3I 100 - 28 × 250 100 LB	6	38,6
	23,2	714	4,5	MR 3I 125 - 24 × 200 90 LB	4	60,2
	26,5	627	1,06	MR 3I 80 - 19 × 200 90 LB	* 4	52,9
	26,9	617	0,95	MR 3I 80 - 24 × 200 90 LB	4	52
	26,5	627	1,25	MR 3I 81 - 19 × 200 90 LB	* 4	52,9
	26,9	617	1,06	MR 3I 81 - 24 × 200 90 LB	4	52
	28,6	582	2,8	MR 3I 100 - 24 × 200 90 LB	4	49
	31,2	543	2,24	MR 2I 100 - 28 × 250 100 LB	6	28,8
	33,6	494	1,32	MR 3I 80 - 24 × 200 90 LB	4	41,7
	33,6	494	1,6	MR 3I 81 - 24 × 200 90 LB	4	41,7
	34,6	490	1,18	MR 2I 80 - 28 × 250 100 LB	6	26
	34,6	490	1,4	MR 2I 81 - 28 × 250 100 LB	6	26
	34,3	484	3,55	MR 3I 100 - 24 × 200 90 LB	4	40,8
	37,9	447	3	MR 2I 100 - 28 × 250 100 LB	6	23,7
	44,7	372	2	MR 3I 80 - 24 × 200 90 LB	4	31,3
	44,7	372	2,36	MR 3I 81 - 24 × 200 90 LB	4	31,3
	43,2	393	1,7	MR 2I 80 - 28 × 250 100 LB	6	20,8
	43,2	393	2	MR 2I 81 - 28 × 250 100 LB	6	20,8
	58,1	292	0,9	MR 2I 63 - 24 × 200 90 LB	4	24,1
	55,9	304	1,18	MR 2I 64 - 24 × 200 90 LB	4	25,1
	51,1	325	2	MR 3I 80 - 24 × 200 90 LB	4	27,4
	51,1	325	2,36	MR 3I 81 - 24 × 200 90 LB	4	27,4
	53,8	315	1,8	MR 2I 80 - 24 × 200 90 LB	4	26
	53,8	315	2,12	MR 2I 81 - 24 × 200 90 LB	4	26
	72,6	233	1,32	MR 2I 63 - 24 × 200 90 LB	4	19,3
	69,7	243	1,6	MR 2I 64 - 24 × 200 90 LB	4	20,1
68	244	3	MR 3I 80 - 24 × 200 90 LB	4	20,6	
67,2	252	2,65	MR 2I 80 - 24 × 200 90 LB	4	20,8	
88,4	192	1,7	MR 2I 63 - 24 × 200 90 LB	4	15,8	
84,7	200	2,12	MR 2I 64 - 24 × 200 90 LB	4	16,5	
89,4	190	3,55	MR 2I 80 - 24 × 200 90 LB	4	15,7	
107	158	1,9	MR 2I 63 - 24 × 200 90 LB	4	13,1	
102	166	4	MR 2I 80 - 24 × 200 90 LB	4	13,7	
130	130	2,5	MR 2I 63 - 24 × 200 90 LB	4	10,7	
136	125	5,6	MR 2I 80 - 24 × 200 90 LB	4	10,3	
169	100	3,55	MR 2I 63 - 24 × 200 90 LB	4	8,26	
214	79	3,75	MR 2I 63 - 24 × 200 90 LB	4	6,53	
2,2	5,89	3280	1,06	MR 4I 125 - 28 × 250 112 M	6	153
	7,44	2599	1,32	MR 4I 125 - 24 × 200 90 LC	4	188
	7,34	2636	1,18	MR 4I 125 - 28 × 250 100 LA	4	191
	7,06	2691	1,5	MR 3I 140 - 28 × 250 112 M	6	123
	7,06	2799	2,36	MR 3I 160 - 28 × 250 112 M	6	128
6,85	2883	3,35	MR 3I 180 - 28 × 250 112 M	6	131	

1) Powers valid for continuous duty S1; **increase possible** for duty cycles S2 ... S10 (see ch. 1 «General specifications»); in which case M_2 increases and f_s decreases.

2) For complete designation when ordering see ch. 2.

* Mounting position **B5R** (see ch. 1.2).

11 - Selection tables (helical gearmotors)

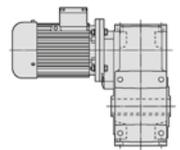

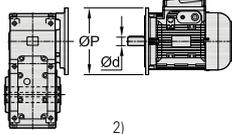
P_1 kW	n_2 min ⁻¹	M_2 N m	f_s		i
1)				2)	
2,2	9,06	2135	1,6	MR 4I 125 - 24 × 200 90 LC	4 155
	9,17	2109	1,7	MR 4I 125 - 28 × 250 100 LA	4 153
	9	2194	2,36	MR 3I 140 - 28 × 250 112 M	6 100
	8,4	2350	3,35	MR 3I 160 - 28 × 250 112 M	6 107
	10,1	1961	2,5	MR 3I 140 - 28 × 250 112 M	6 89,4
	10,8	1793	1	MR 4I 100 - 24 × 200 90 LC	4 130
	11	1762	2	MR 4I 125 - 24 × 200 90 LC	4 128
	11,2	1732	2	MR 4I 125 - 28 × 250 100 LA	4 125
	12	1652	1,6	MR 3I 125 - 28 × 250 112 M	6 75,3
	11,4	1730	2,24	MR 3I 140 - 28 × 250 100 LA	4 123
	14,1	1371	1,25	MR 4I 100 - 24 × 200 90 LC	4 99,3
	15,5	1272	1,12	MR 3I 100 - 19 × 200 90 LC	* 4 90,1
	15,6	1266	1	MR 3I 100 - 28 × 250 112 M	6 57,7
	13,5	1430	2,5	MR 4I 125 - 28 × 250 100 LA	4 104
	15,1	1311	2	MR 3I 125 - 24 × 200 90 LC	4 92,9
	14,7	1340	2	MR 3I 125 - 28 × 250 112 M	6 61,1
	14	1411	3,35	MR 3I 140 - 28 × 250 100 LA	4 100
	15,7	1261	3,75	MR 3I 140 - 28 × 250 100 LA	4 89,4
	16,9	1141	1,5	MR 4I 100 - 24 × 200 90 LC	4 82,7
	18,5	1065	1,32	MR 3I 100 - 19 × 200 90 LC	* 4 75,5
	19,1	1033	1,25	MR 3I 100 - 24 × 200 90 LC	4 73,2
	19	1041	1,32	MR 3I 100 - 28 × 250 112 M	6 47,4
	18,6	1062	2,5	MR 3I 125 - 28 × 250 100 LA	4 75,3
	22,8	867	1,9	MR 3I 100 - 19 × 200 90 LC	* 4 61,5
	23,3	849	1,6	MR 3I 100 - 24 × 200 90 LC	4 60,2
	24,3	814	1,5	MR 3I 100 - 28 × 250 100 LA	4 57,7
	23,3	848	1,9	MR 3I 100 - 28 × 250 112 M	6 38,6
	22,9	862	3	MR 3I 125 - 28 × 250 100 LA	4 61,1
	26,5	746	0,9	MR 3I 80 - 19 × 200 90 LC	* 4 52,9
	26,9	734	0,8	MR 3I 80 - 24 × 200 90 LC	4 52
	26,5	746	1,06	MR 3I 81 - 19 × 200 90 LC	* 4 52,9
	26,9	734	0,9	MR 3I 81 - 24 × 200 90 LC	4 52
	28,6	692	2,36	MR 3I 100 - 24 × 200 90 LC	4 49
	29,5	669	2	MR 3I 100 - 28 × 250 100 LA	4 47,4
	28	706	2,5	MR 3I 100 - 28 × 250 112 M	6 32,2
	31,2	646	1,9	MR 2I 100 - 28 × 250 112 M	6 28,8
	33,6	588	1,12	MR 3I 80 - 24 × 200 90 LC	4 41,7
	33,6	588	1,32	MR 3I 81 - 24 × 200 90 LC	4 41,7
	34,6	583	1	MR 2I 80 - 28 × 250 112 M	6 26
	34,6	583	1,12	MR 2I 81 - 28 × 250 112 M	6 26
	36,2	545	3	MR 3I 100 - 28 × 250 100 LA	4 38,6
	37,9	532	2,5	MR 2I 100 - 28 × 250 112 M	6 23,7
	44,7	442	1,7	MR 3I 80 - 24 × 200 90 LC	4 31,3
	44,7	442	2	MR 3I 81 - 24 × 200 90 LC	4 31,3
	43,2	467	1,4	MR 2I 80 - 28 × 250 112 M	6 20,8
	43,2	467	1,7	MR 2I 81 - 28 × 250 112 M	6 20,8
	43,5	454	3,75	MR 3I 100 - 28 × 250 100 LA	4 32,2
	48,6	415	3	MR 2I 100 - 24 × 200 90 LC	4 28,8
	48,6	415	3	MR 2I 100 - 28 × 250 100 LA	4 28,8
	46,6	433	3,55	MR 2I 100 - 28 × 250 112 M	6 19,3
	55,9	361	0,95	MR 2I 64 - 24 × 200 90 LC	4 25,1
	51,1	386	1,7	MR 3I 80 - 24 × 200 90 LC	4 27,4
	51,1	386	2	MR 3I 81 - 24 × 200 90 LC	4 27,4
	53,8	375	1,5	MR 2I 80 - 24 × 200 90 LC	4 26
	53,8	375	1,8	MR 2I 81 - 24 × 200 90 LC	4 26
	53,8	375	1,5	MR 2I 80 - 28 × 250 100 LA	4 26
	53,8	375	1,8	MR 2I 81 - 28 × 250 100 LA	4 26
	57,4	351	1,9	MR 2I 80 - 28 × 250 112 M	6 15,7
	57,4	351	2,24	MR 2I 81 - 28 × 250 112 M	6 15,7
	56,9	347	4,5	MR 3I 100 - 28 × 250 100 LA	4 24,6
	59	342	4	MR 2I 100 - 24 × 200 90 LC	4 23,7
	59	342	4	MR 2I 100 - 28 × 250 100 LA	4 23,7
	72,6	278	1,12	MR 2I 63 - 24 × 200 90 LC	4 19,3
	69,7	289	1,32	MR 2I 64 - 24 × 200 90 LC	4 20,1
	68	290	2,5	MR 3I 80 - 24 × 200 90 LC	4 20,6
	67,2	300	2,24	MR 2I 80 - 24 × 200 90 LC	4 20,8
	67,2	300	2,24	MR 2I 80 - 28 × 250 100 LA	4 20,8
	68,4	289	6	MR 3I 100 - 28 × 250 100 LA	4 20,5

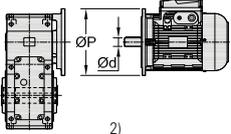
P_1 kW	n_2 min ⁻¹	M_2 N m	f_s		i
1)				2)	
2,2	88,4	228	1,4	MR 2I 63 - 24 × 200 90 LC	4 15,8
	84,7	238	1,8	MR 2I 64 - 24 × 200 90 LC	4 16,5
	89,4	226	3	MR 2I 80 - 24 × 200 90 LC	4 15,7
	89,4	226	3	MR 2I 80 - 28 × 250 100 LA	4 15,7
	107	188	1,6	MR 2I 63 - 24 × 200 90 LC	4 13,1
	103	196	1,9	MR 2I 64 - 24 × 200 90 LC	4 13,6
	102	197	3,35	MR 2I 80 - 24 × 200 90 LC	4 13,7
	102	197	3,35	MR 2I 80 - 28 × 250 100 LA	4 13,7
	130	155	2,12	MR 2I 63 - 24 × 200 90 LC	4 10,7
	125	161	2,65	MR 2I 64 - 24 × 200 90 LC	4 11,2
	136	148	4,75	MR 2I 80 - 28 × 250 100 LA	4 10,3
	169	119	3	MR 2I 63 - 24 × 200 90 LC	4 8,26
	175	115	3,35	MR 2I 64 - 24 × 200 90 LC	4 7,99
	174	116	5,6	MR 2I 80 - 28 × 250 100 LA	4 8,03
	214	94	3,15	MR 2I 63 - 24 × 200 90 LC	4 6,53
	204	99	3,35	MR 2I 64 - 24 × 200 90 LC	4 6,86
	218	92	6,3	MR 2I 80 - 28 × 250 100 LA	4 6,41
3	7,34	3670	1,12	MR 3I 140 - 28 × 250 112 MC	6 123
	7,06	3817	1,7	MR 3I 160 - 28 × 250 112 MC	6 128
	7,06	3817	1,7	MR 3I 160 - 38 × 300 132 S	6 128
	6,85	3932	2,36	MR 3I 180 - 38 × 300 132 S	6 131
	9,17	2875	1,18	MR 4I 125 - 28 × 250 100 LB	4 153
	9	2992	1,7	MR 3I 140 - 28 × 250 112 MC	6 100
	8,4	3205	2,36	MR 3I 160 - 28 × 250 112 MC	6 107
	8,4	3205	2,36	MR 3I 160 - 38 × 300 132 S	6 107
	8,36	3220	3,15	MR 3I 180 - 38 × 300 132 S	6 108
	10,1	2674	1,8	MR 3I 140 - 28 × 250 112 MC	6 89,4
	9,61	2803	2,8	MR 3I 160 - 28 × 250 112 MC	6 93,7
	9,61	2803	2,8	MR 3I 160 - 38 × 300 132 S	6 93,7
	11,2	2362	1,5	MR 4I 125 - 28 × 250 100 LB	4 125
	12	2253	1,18	MR 3I 125 - 28 × 250 112 MC	6 75,3
	11,4	2359	1,6	MR 3I 140 - 28 × 250 100 LB	4 123
	11	2454	2,5	MR 3I 160 - 28 × 250 100 LB	4 128
	13,5	1949	1,8	MR 4I 125 - 28 × 250 100 LB	4 104
	15,1	1787	1,5	MR 3I 125 - 24 × 200 100 LB	* 4 92,9
	14,7	1828	1,5	MR 3I 125 - 28 × 250 112 MC	6 61,1
	14	1924	2,5	MR 3I 140 - 28 × 250 100 LB	4 100
	15,7	1719	2,8	MR 3I 140 - 28 × 250 100 LB	4 89,4
	19,1	1408	0,9	MR 3I 100 - 24 × 200 100 LB	* 4 73,2
	19	1420	1	MR 3I 100 - 28 × 250 112 MC	6 47,4
	16,5	1601	2,24	MR 4I 125 - 28 × 250 100 LB	4 85,1
	18,6	1448	1,8	MR 3I 125 - 28 × 250 100 LB	4 75,3
	18,4	1462	2,12	MR 3I 125 - 28 × 250 112 MC	6 48,9
	17,2	1566	3	MR 3I 140 - 28 × 250 100 LB	4 81,4
	19,2	1400	3,55	MR 3I 140 - 28 × 250 100 LB	4 72,8
	24,3	1109	1,12	MR 3I 100 - 28 × 250 100 LB	4 57,7
	23,3	1156	1,4	MR 3I 100 - 28 × 250 112 MC	6 38,6
	22,9	1175	2,24	MR 3I 125 - 28 × 250 100 LB	4 61,1
	29,5	913	1,5	MR 3I 100 - 28 × 250 100 LB	4 47,4
	28	962	1,8	MR 3I 100 - 28 × 250 112 MC	6 32,2
	31,2	881	1,4	MR 2I 100 - 28 × 250 112 MC	6 28,8
	31,2	881	1,4	MR 2I 100 - 38 × 300 132 S	6 28,8
	28,6	940	3,35	MR 3I 125 - 28 × 250 100 LB	4 48,9
	33,6	802	0,85	MR 3I 80 - 24 × 200 100 LB	* 4 41,7
	33,6	802	0,95	MR 3I 81 - 24 × 200 100 LB	* 4 41,7
	34,6	795	0,85	MR 2I 81 - 28 × 250 112 MC	6 26
	36,2	743	2,12	MR 3I 100 - 28 × 250 100 LB	4 38,6
	37,9	725	1,9	MR 2I 100 - 28 × 250 112 MC	6 23,7
	37,9	725	1,9	MR 2I 100 - 38 × 300 132 S	6 23,7
	34,9	772	4,5	MR 3I 125 - 28 × 250 100 LB	4 40,1
	37,4	736	3,55	MR 2I 125 - 28 × 250 112 MC	6 24,1
	37,4	736	3,55	MR 2I 125 - 38 × 300 132 S	6 24,1

11

1) Powers valid for continuous duty S1; **increase possible** for duty cycles S2 ... S10 (see ch. 1 «General specifications»); in which case M_2 increases and f_s decreases.

2) For complete designation when ordering see ch. 2.

* Mounting position **B5R** (see ch. 1.2).

11 - Selection tables (helical gearmotors)

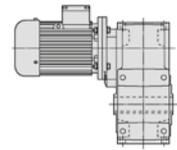

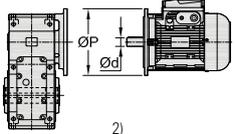
P_1 kW	n_2 min ⁻¹	M_2 N m	f_s		i	
1)				2)		
3	44,7	603	1,25	MR 3I 80 - 24 × 200 100 LB * 4	31,3	
	44,7	603	1,5	MR 3I 81 - 24 × 200 100 LB * 4	31,3	
	43,2	637	1,06	MR 2I 80 - 28 × 250 112 MC 6	20,8	
	43,2	637	1,18	MR 2I 81 - 28 × 250 112 MC 6	20,8	
	43,5	619	2,8	MR 3I 100 - 28 × 250 100 LB 4	32,2	
	48,6	566	2,12	MR 2I 100 - 28 × 250 100 LB 4	28,8	
	46,6	590	2,65	MR 2I 100 - 28 × 250 112 MC 6	19,3	
	46,6	590	2,65	MR 2I 100 - 38 × 300 132 S 6	19,3	
	51,1	527	1,25	MR 3I 80 - 24 × 200 100 LB * 4	27,4	
	51,1	527	1,5	MR 3I 81 - 24 × 200 100 LB * 4	27,4	
	53,8	511	1,12	MR 2I 80 - 28 × 250 100 LB 4	26	
	53,8	511	1,32	MR 2I 81 - 28 × 250 100 LB 4	26	
	57,4	479	1,4	MR 2I 80 - 28 × 250 112 MC 6	15,7	
	57,4	479	1,7	MR 2I 81 - 28 × 250 112 MC 6	15,7	
	56,9	473	3,35	MR 3I 100 - 28 × 250 100 LB 4	24,6	
	59	466	2,8	MR 2I 100 - 28 × 250 100 LB 4	23,7	
	69,7	394	0,95	MR 2I 64 - 24 × 200 100 LB * 4	20,1	
	68	396	1,9	MR 3I 80 - 24 × 200 100 LB * 4	20,6	
	68	396	2,24	MR 3I 81 - 24 × 200 100 LB * 4	20,6	
	67,2	409	1,6	MR 2I 80 - 28 × 250 100 LB 4	20,8	
	67,2	409	1,9	MR 2I 81 - 28 × 250 100 LB 4	20,8	
	68,4	394	4,5	MR 3I 100 - 28 × 250 100 LB 4	20,5	
	72,5	379	4	MR 2I 100 - 28 × 250 100 LB 4	19,3	
	84,7	325	1,32	MR 2I 64 - 24 × 200 100 LB * 4	16,5	
	89,4	308	2,12	MR 2I 80 - 28 × 250 100 LB 4	15,7	
	103	267	1,4	MR 2I 64 - 24 × 200 100 LB * 4	13,6	
	102	269	2,36	MR 2I 80 - 28 × 250 100 LB 4	13,7	
	125	220	1,9	MR 2I 64 - 24 × 200 100 LB * 4	11,2	
	136	202	3,55	MR 2I 80 - 28 × 250 100 LB 4	10,3	
	175	157	2,5	MR 2I 64 - 24 × 200 100 LB * 4	7,99	
	174	158	4,25	MR 2I 80 - 28 × 250 100 LB 4	8,03	
	204	135	2,36	MR 2I 64 - 24 × 200 100 LB * 4	6,86	
	218	126	4,5	MR 2I 80 - 28 × 250 100 LB 4	6,41	
	4	7,06	5089	1,25	MR 3I 160 - 38 × 300 132 M 6	128
		6,85	5242	1,8	MR 3I 180 - 38 × 300 132 M 6	131
		7,55	4754	2,8	MR 3I 200 - 38 × 300 132 M 6	119
		8,4	4273	1,8	MR 3I 160 - 38 × 300 132 M 6	107
		8,36	4294	2,36	MR 3I 180 - 38 × 300 132 M 6	108
		9,61	3737	2,12	MR 3I 160 - 38 × 300 132 M 6	93,7
		9,65	3721	2,5	MR 3I 180 - 38 × 300 132 M 6	93,3
11,2		3149	1,12	MR 4I 125 - 28 × 250 112 M 4	125	
11,4		3146	1,25	MR 3I 140 - 28 × 250 112 M 4	123	
11		3272	1,9	MR 3I 160 - 28 × 250 112 M 4	128	
10,5		3418	2,12	MR 3I 160 - 38 × 300 132 M 6	85,7	
10,7		3370	2,65	MR 3I 180 - 28 × 250 112 M 4	131	
13,5		2599	1,32	MR 4I 125 - 28 × 250 112 M 4	104	
15,1		2383	1,12	MR 3I 125 - 24 × 200 112 M * 4	92,9	
14		2565	1,9	MR 3I 140 - 28 × 250 112 M 4	100	
13,1		2747	2,65	MR 3I 160 - 28 × 250 112 M 4	107	
15,7		2292	2,12	MR 3I 140 - 28 × 250 112 M 4	89,4	
14,9		2403	3,15	MR 3I 160 - 28 × 250 112 M 4	93,7	
18,6		1931	1,4	MR 3I 125 - 28 × 250 112 M 4	75,3	
17,2		2088	2,24	MR 3I 140 - 28 × 250 112 M 4	81,4	
19,2		1866	2,65	MR 3I 140 - 28 × 250 112 M 4	72,8	
23,3		1544	0,9	MR 3I 100 - 24 × 200 112 M * 4	60,2	
22,9		1567	1,7	MR 3I 125 - 28 × 250 112 M 4	61,1	
22,6		1589	2,8	MR 3I 140 - 28 × 250 112 M 4	62	
25,3		1420	3,35	MR 3I 140 - 28 × 250 112 M 4	55,4	
28,6		1257	1,25	MR 3I 100 - 24 × 200 112 M * 4	49	
29,5		1217	1,12	MR 3I 100 - 28 × 250 112 M 4	47,4	
31,2		1175	1,06	MR 2I 100 - 38 × 300 132 M 6	28,8	
28,6		1253	2,5	MR 3I 125 - 28 × 250 112 M 4	48,9	
36,2		991	1,6	MR 3I 100 - 28 × 250 112 M 4	38,6	
37,9		967	1,4	MR 2I 100 - 38 × 300 132 M 6	23,7	
34,9		1030	3,35	MR 3I 125 - 28 × 250 112 M 4	40,1	
37,4		982	2,65	MR 2I 125 - 38 × 300 132 M 6	24,1	

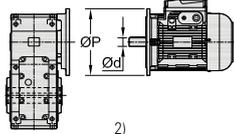
P_1 kW	n_2 min ⁻¹	M_2 N m	f_s		i	
1)				2)		
4	43,5	825	2,12	MR 3I 100 - 28 × 250 112 M 4	32,2	
	48,6	755	1,6	MR 2I 100 - 28 × 250 112 M 4	28,8	
	46,6	787	2	MR 2I 100 - 38 × 300 132 M 6	19,3	
	42,3	850	3,55	MR 3I 125 - 28 × 250 112 M 4	33,1	
	46,7	785	4	MR 2I 125 - 38 × 300 132 M 6	19,3	
	53,8	681	0,85	MR 2I 80 - 28 × 250 112 M 4	26	
	53,8	681	0,95	MR 2I 81 - 28 × 250 112 M 4	26	
	56,9	631	2,5	MR 3I 100 - 28 × 250 112 M 4	24,6	
	59	621	2,12	MR 2I 100 - 28 × 250 112 M 4	23,7	
	58,1	631	4	MR 2I 125 - 38 × 250 112 M 4	24,1	
	67,2	546	1,18	MR 2I 80 - 28 × 250 112 M 4	20,8	
	67,2	546	1,4	MR 2I 81 - 28 × 250 112 M 4	20,8	
	68,4	525	3,35	MR 3I 100 - 28 × 250 112 M 4	20,5	
	72,5	506	3	MR 2I 100 - 28 × 250 112 M 4	19,3	
	89,4	410	1,6	MR 2I 80 - 28 × 250 112 M 4	15,7	
	89,4	410	1,9	MR 2I 81 - 28 × 250 112 M 4	15,7	
	87,1	421	3,35	MR 2I 100 - 28 × 250 112 M 4	16,1	
	102	359	1,8	MR 2I 80 - 28 × 250 112 M 4	13,7	
	102	359	2,12	MR 2I 81 - 28 × 250 112 M 4	13,7	
	114	322	4,75	MR 2I 100 - 28 × 250 112 M 4	12,3	
	136	270	2,65	MR 2I 80 - 28 × 250 112 M 4	10,3	
	136	270	2,8	MR 2I 81 - 28 × 250 112 M 4	10,3	
	137	268	5	MR 2I 100 - 28 × 250 112 M 4	10,2	
	174	210	3,15	MR 2I 80 - 28 × 250 112 M 4	8,03	
	218	168	3,35	MR 2I 80 - 28 × 250 112 M 4	6,41	
	5,5	6,85	7208	1,32	MR 3I 180 - 38 × 300 132 MB 6	131
		7,55	6537	2	MR 3I 200 - 38 × 300 132 MB 6	119
		7,33	6734	2,8	MR 3I 225 - 38 × 300 132 MB 6	123
		8,4	5875	1,32	MR 3I 160 - 38 × 300 132 MB 6	107
		8,36	5904	1,8	MR 3I 180 - 38 × 300 132 MB 6	108
		9	5489	2,8	MR 3I 200 - 38 × 300 132 MB 6	100
		9,61	5139	1,5	MR 3I 160 - 38 × 300 132 MB 6	93,7
		9,65	5117	1,8	MR 3I 180 - 38 × 300 132 MB 6	93,3
		10,4	4742	3,35	MR 3I 200 - 38 × 300 132 MB 6	86,4
		11,4	4325	0,9	MR 3I 140 - 28 × 250 112 MC 4	123
		11,8	4168	0,9	MR 3I 140 - 38 × 300 132 MB 6	76
		11	4498	1,32	MR 3I 160 - 28 × 250 112 MC 4	128
		11	4498	1,32	MR 3I 160 - 38 × 300 132 S 4	128
		10,5	4700	1,6	MR 3I 160 - 38 × 300 132 MB 6	85,7
		10,7	4634	1,9	MR 3I 180 - 28 × 250 112 MC 4	131
10,7		4634	1,9	MR 3I 180 - 38 × 300 132 S 4	131	
11,7		4203	2,8	MR 3I 200 - 38 × 300 132 S 4	119	
13,5		3574	1	MR 4I 125 - 28 × 250 112 MC 4	104	
14		3527	1,32	MR 3I 140 - 28 × 250 112 MC 4	100	
14,5		3399	1,4	MR 3I 140 - 38 × 300 132 MB 6	62	
13,1		3777	1,9	MR 3I 160 - 28 × 250 112 MC 4	107	
13,1		3777	1,9	MR 3I 160 - 38 × 300 132 S 4	107	
13		3795	2,5	MR 3I 180 - 38 × 300 132 S 4	108	
15,7		3151	1,5	MR 3I 140 - 28 × 250 112 MC 4	89,4	
16,3		3037	1,6	MR 3I 140 - 38 × 300 132 MB 6	55,4	
14,9		3303	2,36	MR 3I 160 - 28 × 250 112 MC 4	93,7	
14,9		3303	2,36	MR 3I 160 - 38 × 300 132 S 4	93,7	
15		3289	2,65	MR 3I 180 - 38 × 300 132 S 4	93,3	
16,5		2936	1,18	MR 4I 125 - 28 × 250 112 MC 4	85,1	
18,6		2655	1	MR 3I 125 - 28 × 250 112 MC 4	75,3	
18,4	2683	1	MR 3I 125 - 38 × 300 132 MB 6	48,9		
17,2	2872	1,6	MR 3I 140 - 28 × 250 112 MC 4	81,4		
18,4	2680	1,4	MR 3I 140 - 38 × 300 132 S 4	76		
16,3	3021	2,36	MR 3I 160 - 28 × 250 112 MC 4	85,7		
16,3	3021	2,36	MR 3I 160 - 38 × 300 132 S 4	85,7		
16,3	3036	3,15	MR 3I 180 - 38 × 300 132 S 4	86,1		
19,2	2566	1,9	MR 3I 140 - 28 × 250 112 MC 4	72,8		
18,7	2643	2,8	MR 3I 160 - 38 × 300 132 S 4	74,9		
22,9	2154	1,25	MR 3I 125 - 28 × 250 112 MC 4	61,1		
23	2147	1,5	MR 3I 125 - 38 × 300 132 MB 6	39,1		
22,6	2185	2,12	MR 3I 140 - 28 × 250 112 MC 4	62		
22,6	2185	2,12	MR 3I 140 - 38 × 300 132 S 4	62		
22,1	2239	3,15	MR 3I 160 - 38 × 300 132 S 4	63,5		

1) Powers valid for continuous duty S1; **increase possible** for duty cycles S2 ... S10 (see ch. 1 «General specifications»); in which case M_2 increases and f_s decreases.
2) For complete designation when ordering see ch. 2.

* Mounting position **B5R** (see ch. 1.2).

11 - Selection tables (helical gearmotors)

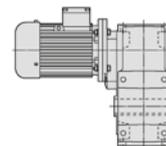

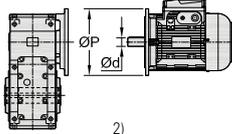
P_1 kW	n_2 min ⁻¹	M_2 N m	f_s		i
1)				2)	
5,5	25,3	1952	2,36	MR 3I 140 - 38 × 300 132 S	4 55,4
	28,6	1723	1,8	MR 3I 125 - 28 × 250 112 MC	4 48,9
	28,6	1725	1,5	MR 3I 125 - 38 × 300 132 S	4 48,9
	28	1763	2	MR 3I 125 - 38 × 300 132 MB	6 32,1
	27,8	1779	2,5	MR 3I 140 - 38 × 300 132 S	4 50,4
	31,1	1590	3	MR 3I 140 - 38 × 300 132 S	4 45,1
	36,2	1362	1,18	MR 3I 100 - 28 × 250 112 MC	4 38,6
	37,9	1329	1	MR 2I 100 - 38 × 300 132 MB	6 23,7
	34,9	1416	2,5	MR 3I 125 - 28 × 250 112 MC	4 40,1
	35,8	1380	2,24	MR 3I 125 - 38 × 300 132 S	4 39,1
	37,4	1350	1,9	MR 2I 125 - 38 × 300 132 MB	6 24,1
	43,5	1134	1,5	MR 3I 100 - 28 × 250 112 MC	4 32,2
	48,6	1039	1,18	MR 2I 100 - 28 × 250 112 MC	4 28,8
	48,6	1039	1,18	MR 2I 100 - 38 × 300 132 S	4 28,8
	46,6	1082	1,5	MR 2I 100 - 38 × 300 132 MB	6 19,3
	43,6	1134	3	MR 3I 125 - 38 × 300 132 S	4 32,1
	46,7	1080	2,8	MR 2I 125 - 38 × 300 132 MB	6 19,3
	56,9	867	1,8	MR 3I 100 - 28 × 250 112 MC	4 24,6
	59	854	1,6	MR 2I 100 - 28 × 250 112 MC	4 23,7
	59	854	1,6	MR 2I 100 - 38 × 300 132 S	4 23,7
	52,8	936	3,35	MR 3I 125 - 38 × 300 132 S	4 26,5
	58,1	868	3	MR 2I 125 - 28 × 250 112 MC	4 24,1
	58,1	868	3	MR 2I 125 - 38 × 300 132 S	4 24,1
	67,2	750	0,9	MR 2I 80 - 28 × 250 112 MC	4 20,8
	67,2	750	1	MR 2I 81 - 28 × 250 112 MC	4 20,8
	68,4	722	2,36	MR 3I 100 - 28 × 250 112 MC	4 20,5
	72,5	696	2,24	MR 2I 100 - 28 × 250 112 MC	4 19,3
	72,5	696	2,24	MR 2I 100 - 38 × 300 132 S	4 19,3
	64,2	769	4,5	MR 3I 125 - 38 × 300 132 S	4 21,8
	72,6	694	4	MR 2I 125 - 38 × 300 132 S	4 19,3
	89,4	564	1,18	MR 2I 80 - 28 × 250 112 MC	4 15,7
	89,4	564	1,4	MR 2I 81 - 28 × 250 112 MC	4 15,7
	87,1	579	2,5	MR 2I 100 - 28 × 250 112 MC	4 16,1
	87,1	579	2,5	MR 2I 100 - 38 × 300 132 S	4 16,1
	102	493	1,32	MR 2I 80 - 28 × 250 112 MC	4 13,7
	102	493	1,5	MR 2I 81 - 28 × 250 112 MC	4 13,7
	114	443	3,55	MR 2I 100 - 28 × 250 112 MC	4 12,3
	114	443	3,55	MR 2I 100 - 38 × 300 132 S	4 12,3
	136	371	1,9	MR 2I 80 - 28 × 250 112 MC	4 10,3
	136	371	2,12	MR 2I 81 - 28 × 250 112 MC	4 10,3
	137	369	3,55	MR 2I 100 - 38 × 300 132 S	4 10,2
	174	289	2,24	MR 2I 80 - 28 × 250 112 MC	4 8,03
	174	289	2,65	MR 2I 81 - 28 × 250 112 MC	4 8,03
	175	288	4,75	MR 2I 100 - 38 × 300 132 S	4 8,01
	218	231	2,5	MR 2I 80 - 28 × 250 112 MC	4 6,41
	218	231	2,8	MR 2I 81 - 28 × 250 112 MC	4 6,41
	218	231	5,3	MR 2I 100 - 38 × 300 132 S	4 6,42
	7,5	7,55	8914	1,5	MR 3I 200 - 38 × 300 132 MC
7,55		8914	1,5	MR 3I 200 - 42 × 350 160 M	6 119
7,33		9183	2	MR 3I 225 - 38 × 300 132 MC	6 123
7,33		9183	2	MR 3I 225 - 42 × 350 160 M	6 123
8,36		8051	1,32	MR 3I 180 - 38 × 300 132 MC	6 108
9		7484	2	MR 3I 200 - 38 × 300 132 MC	6 100
9		7484	2	MR 3I 200 - 42 × 350 160 M	6 100
9,13		7372	3	MR 3I 225 - 38 × 300 132 MC	6 98,5
9,13		7372	3	MR 3I 225 - 42 × 350 160 M	6 98,5
9,61		7007	1,12	MR 3I 160 - 38 × 300 132 MC	6 93,7
9,65		6978	1,32	MR 3I 180 - 38 × 300 132 MC	6 93,3
10,4		6467	2,5	MR 3I 200 - 38 × 300 132 MC	6 86,4
10,4		6467	2,5	MR 3I 200 - 42 × 350 160 M	6 86,4
10,1		6639	3,35	MR 3I 225 - 38 × 300 132 MC	6 88,8
10,1		6639	3,35	MR 3I 225 - 42 × 350 160 M	6 88,8
11		6134	1	MR 3I 160 - 38 × 300 132 M	4 128
10,5		6409	1,18	MR 3I 160 - 38 × 300 132 MC	6 85,7
10,7		6319	1,4	MR 3I 180 - 38 × 300 132 M	4 131
11,7		5731	2,12	MR 3I 200 - 38 × 300 132 M	4 119
11,4		5903	3	MR 3I 225 - 38 × 300 132 M	4 123

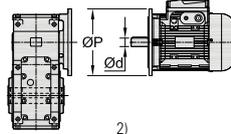
P_1 kW	n_2 min ⁻¹	M_2 N m	f_s		i
1)				2)	
7,5	14,5	4635	1	MR 3I 140 - 38 × 300 132 MC	6 62
	13,1	5150	1,4	MR 3I 160 - 38 × 300 132 M	4 107
	13	5176	1,9	MR 3I 180 - 38 × 300 132 M	4 108
	14	4811	3	MR 3I 200 - 38 × 300 132 M	4 100
	16,3	4141	1,18	MR 3I 140 - 38 × 300 132 MC	6 55,4
	14,9	4505	1,7	MR 3I 160 - 38 × 300 132 M	4 93,7
	15	4486	2	MR 3I 180 - 38 × 300 132 M	4 93,3
	16,2	4157	3,55	MR 3I 200 - 38 × 300 132 M	4 86,4
	18,4	3654	1	MR 3I 140 - 38 × 300 132 M	4 76
	17,8	3774	1,25	MR 3I 140 - 38 × 300 132 MC	6 50,4
	16,3	4120	1,7	MR 3I 160 - 38 × 300 132 M	4 85,7
	16,3	4141	2,24	MR 3I 180 - 38 × 300 132 M	4 86,1
	20	3372	1,4	MR 3I 140 - 38 × 300 132 MC	6 45,1
	18,7	3604	2,12	MR 3I 160 - 38 × 300 132 M	4 74,9
	18,8	3588	2,8	MR 3I 180 - 38 × 300 132 M	4 74,6
	22,9	2938	0,9	MR 3I 125 - 28 × 250 132 M	* 4 61,1
	23	2927	1,06	MR 3I 125 - 38 × 300 132 MC	6 39,1
	22,6	2979	1,5	MR 3I 140 - 38 × 300 132 M	4 62
	22,1	3053	2,24	MR 3I 160 - 38 × 300 132 M	4 63,5
	25,3	2662	1,8	MR 3I 140 - 38 × 300 132 M	4 55,4
	25,2	2670	2,8	MR 3I 160 - 38 × 300 132 M	4 55,5
	28,6	2350	1,32	MR 3I 125 - 28 × 250 132 M	* 4 48,9
	28,6	2352	1,12	MR 3I 125 - 38 × 300 132 M	4 48,9
	28	2404	1,5	MR 3I 125 - 38 × 300 132 MC	6 32,1
	27,8	2426	1,9	MR 3I 140 - 38 × 300 132 M	4 50,4
	27,6	2442	2,8	MR 3I 160 - 38 × 300 132 M	4 50,8
	31,1	2168	2,24	MR 3I 140 - 38 × 300 132 M	4 45,1
	35,8	1882	1,7	MR 3I 125 - 38 × 300 132 M	4 39,1
	37,4	1841	1,4	MR 2I 125 - 38 × 300 132 MC	6 24,1
	37,4	1841	1,4	MR 2I 125 - 42 × 350 160 M	6 24,1
	36,2	1859	2,5	MR 3I 140 - 38 × 300 132 M	4 38,7
	37,3	1805	2,65	MR 3I 140 - 38 × 300 132 M	4 37,5
	46,6	1476	1,06	MR 2I 100 - 38 × 300 132 MC	6 19,3
	43,6	1546	2,24	MR 3I 125 - 38 × 300 132 M	4 32,1
	46,7	1472	2,12	MR 2I 125 - 38 × 300 132 MC	6 19,3
	46,7	1472	2,12	MR 2I 125 - 42 × 350 160 M	6 19,3
	43,5	1548	2,8	MR 3I 140 - 38 × 300 132 M	4 32,2
	48,1	1399	2,8	MR 3I 140 - 38 × 300 132 M	4 29,1
	59	1165	1,18	MR 2I 100 - 38 × 300 132 M	4 23,7
	52,8	1276	2,36	MR 3I 125 - 38 × 300 132 M	4 26,5
	58,1	1183	2,12	MR 2I 125 - 38 × 300 132 M	4 24,1
	58,1	1183	3	MR 2I 140 - 38 × 300 132 M	4 24,1
	72,5	949	1,6	MR 2I 100 - 38 × 300 132 M	4 19,3
	64,2	1048	3,35	MR 3I 125 - 38 × 300 132 M	4 21,8
	72,6	947	2,8	MR 2I 125 - 38 × 300 132 M	4 19,3
	87,1	790	1,8	MR 2I 100 - 38 × 300 132 M	4 16,1
	88,4	778	3,55	MR 2I 125 - 38 × 300 132 M	4 15,8
	114	604	2,5	MR 2I 100 - 38 × 300 132 M	4 12,3
107	642	4,25	MR 2I 125 - 38 × 300 132 M	4 13,1	
137	503	2,65	MR 2I 100 - 38 × 300 132 M	4 10,2	
130	527	5	MR 2I 125 - 38 × 300 132 M	4 10,7	
175	393	3,35	MR 2I 100 - 38 × 300 132 M	4 8,01	
169	406	6,7	MR 2I 125 - 38 × 300 132 M	4 8,26	
218	315	3,75	MR 2I 100 - 38 × 300 132 M	4 6,42	
214	321	7,5	MR 2I 125 - 38 × 300 132 M	4 6,53	
9,2	10,7	7751	1,12	MR 3I 180 - 38 × 300 132 MB	4 131
	11,7	7030	1,7	MR 3I 200 - 38 × 300 132 MB	4 119
	11,4	7242	2,36	MR 3I 225 - 38 × 300 132 MB	4 123
	13,1	6317	1,12	MR 3I 160 - 38 × 300 132 MB	4 107
	13	6349	1,5	MR 3I 180 - 38 × 300 132 MB	4 108
	14	5902	2,36	MR 3I 200 - 38 × 300 132 MB	4 100
	14,9	5526	1,4	MR 3I 160 - 38 × 300 132 MB	4 93,7
	15	5502	1,6	MR 3I 180 - 38 × 300 132 MB	4 93,3
	16,2	5100	3	MR 3I 200 - 38 × 300 132 MB	4 86,4

11

1) Powers valid for continuous duty S1; **increase possible** for duty cycles S2 ... S10 (see ch. 1 «General specifications»); in which case M_2 increases and f_s decreases.
 2) For complete designation when ordering see ch. 2.
 * Mounting position **B5R** (see ch. 1.2).

11 - Selection tables (helical gearmotors)

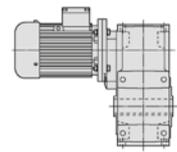

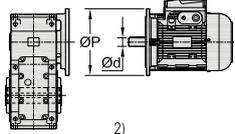
P_1 kW	n_2 min ⁻¹	M_2 N m	f_s		i	
1)				2)		
9,2	18,4	4482	0,85	MR 3I 140 - 38 x 300 132 MB	4 76	
	16,3	5054	1,4	MR 3I 160 - 38 x 300 132 MB	4 85,7	
	16,3	5079	1,8	MR 3I 180 - 38 x 300 132 MB	4 86,1	
	16,7	4955	2,8	MR 3I 200 - 38 x 300 132 MB	4 84	
	18,7	4421	1,7	MR 3I 160 - 38 x 300 132 MB	4 74,9	
	18,8	4402	2,36	MR 3I 180 - 38 x 300 132 MB	4 74,6	
	22,6	3655	1,25	MR 3I 140 - 38 x 300 132 MB	4 62	
	22,1	3745	1,8	MR 3I 160 - 38 x 300 132 MB	4 63,5	
	21,9	3763	2,5	MR 3I 180 - 38 x 300 132 MB	4 63,8	
	25,3	3266	1,4	MR 3I 140 - 38 x 300 132 MB	4 55,4	
	25,2	3275	2,24	MR 3I 160 - 38 x 300 132 MB	4 55,5	
	25,3	3261	2,65	MR 3I 180 - 38 x 300 132 MB	4 55,3	
	28,6	2885	0,9	MR 3I 125 - 38 x 300 132 MB	4 48,9	
	27,8	2976	1,5	MR 3I 140 - 38 x 300 132 MB	4 50,4	
	27,6	2996	2,24	MR 3I 160 - 38 x 300 132 MB	4 50,8	
	27,4	3011	3	MR 3I 180 - 38 x 300 132 MB	4 51	
	31,1	2659	1,8	MR 3I 140 - 38 x 300 132 MB	4 45,1	
	31,5	2620	2,8	MR 3I 160 - 38 x 300 132 MB	4 44,4	
	35,8	2308	1,32	MR 3I 125 - 38 x 300 132 MB	4 39,1	
	36,2	2281	2	MR 3I 140 - 38 x 300 132 MB	4 38,7	
	36,4	2271	3,35	MR 3I 160 - 38 x 300 132 MB	4 38,5	
	37,3	2214	2,12	MR 3I 140 - 38 x 300 132 MB	4 37,5	
	43,6	1896	1,8	MR 3I 125 - 38 x 300 132 MB	4 32,1	
	43,5	1899	2,24	MR 3I 140 - 38 x 300 132 MB	4 32,2	
	48,1	1716	2,24	MR 3I 140 - 38 x 300 132 MB	4 29,1	
	59	1429	0,95	MR 2I 100 - 38 x 300 132 MB	4 23,7	
	52,8	1565	2	MR 3I 125 - 38 x 300 132 MB	4 26,5	
	58,1	1451	1,8	MR 2I 125 - 38 x 300 132 MB	4 24,1	
	58,1	1451	2,36	MR 2I 140 - 38 x 300 132 MB	4 24,1	
	64,6	1306	2,8	MR 2I 140 - 38 x 300 132 MB	4 21,7	
	72,5	1164	1,32	MR 2I 100 - 38 x 300 132 MB	4 19,3	
	64,2	1286	2,65	MR 3I 125 - 38 x 300 132 MB	4 21,8	
	72,6	1161	2,36	MR 2I 125 - 38 x 300 132 MB	4 19,3	
	87,1	969	1,5	MR 2I 100 - 38 x 300 132 MB	4 16,1	
	88,4	954	2,8	MR 2I 125 - 38 x 300 132 MB	4 15,8	
	114	741	2,12	MR 2I 100 - 38 x 300 132 MB	4 12,3	
	107	787	3,35	MR 2I 125 - 38 x 300 132 MB	4 13,1	
	137	617	2,12	MR 2I 100 - 38 x 300 132 MB	4 10,2	
	130	647	4,25	MR 2I 125 - 38 x 300 132 MB	4 10,7	
	175	482	2,8	MR 2I 100 - 38 x 300 132 MB	4 8,01	
	169	498	5,3	MR 2I 125 - 38 x 300 132 MB	4 8,26	
	218	387	3,15	MR 2I 100 - 38 x 300 132 MB	4 6,42	
	214	394	6	MR 2I 125 - 38 x 300 132 MB	4 6,53	
	11	7,55	13075	1	MR 3I 200 - 42 x 350 160 L	6 119
		7,33	13468	1,4	MR 3I 225 - 42 x 350 160 L	6 123
		7,2	13712	2	MR 3I 250 - 42 x 350 160 L	6 125
		7,31	13504	2,65	MR 3I 280 - 42 x 350 160 L	6 123
		9	10977	1,4	MR 3I 200 - 42 x 350 160 L	6 100
9,13		10813	2	MR 3I 225 - 42 x 350 160 L	6 98,5	
9,14		10803	2,8	MR 3I 250 - 42 x 350 160 L	6 98,5	
10,4		9485	1,7	MR 3I 200 - 42 x 350 160 L	6 86,4	
10,1		9738	2,24	MR 3I 225 - 42 x 350 160 L	6 88,8	
10,1		9764	3,15	MR 3I 250 - 42 x 350 160 L	6 89	
11,6		8545	1	MR 3I 180 - 42 x 350 160 L	6 77,9	
11,7		8405	1,4	MR 3I 200 - 38 x 300 132 MC	4 119	
11,7		8405	1,4	MR 3I 200 - 42 x 350 160 M	4 119	
11,4		8658	2	MR 3I 225 - 38 x 300 132 MC	4 123	
11,4		8658	2	MR 3I 225 - 42 x 350 160 M	4 123	
11,2		8815	2,8	MR 3I 250 - 42 x 350 160 M	4 125	
14,2		6965	1	MR 3I 160 - 42 x 350 160 L	6 63,5	
13		7591	1,25	MR 3I 180 - 38 x 300 132 MC	4 108	
14,1		6999	1,4	MR 3I 180 - 42 x 350 160 L	6 63,8	
14		7057	2	MR 3I 200 - 38 x 300 132 MC	4 100	
14		7057	2	MR 3I 200 - 42 x 350 160 M	4 100	
14,2		6951	3	MR 3I 225 - 38 x 300 132 MC	4 98,5	
14,2		6951	3	MR 3I 225 - 42 x 350 160 M	4 98,5	
11		14,9	6607	1,18	MR 3I 160 - 38 x 300 132 MC	4 93,7
		16,2	6092	1,25	MR 3I 160 - 42 x 350 160 L	6 55,5
		15	6579	1,32	MR 3I 180 - 38 x 300 132 MC	4 93,3
		16,3	6066	1,5	MR 3I 180 - 42 x 350 160 L	6 55,3
		16,2	6097	2,5	MR 3I 200 - 38 x 300 132 MC	4 86,4
		16,2	6097	2,5	MR 3I 200 - 42 x 350 160 M	4 86,4
		16,3	6043	1,18	MR 3I 160 - 38 x 300 132 MC	4 85,7
		18,5	5333	1,12	MR 3I 160 - 42 x 350 160 M	4 75,6
		16,3	6073	1,5	MR 3I 180 - 38 x 300 132 MC	4 86,1
		18	5493	1,5	MR 3I 180 - 42 x 350 160 M	4 77,9
		16,7	5925	2,36	MR 3I 200 - 38 x 300 132 MC	4 84
		16,7	5925	2,36	MR 3I 200 - 42 x 350 160 M	4 84
		18,7	5286	1,4	MR 3I 160 - 38 x 300 132 MC	4 74,9
		20,3	4873	1,5	MR 3I 160 - 42 x 350 160 L	6 44,4
		18,8	5263	2	MR 3I 180 - 38 x 300 132 MC	4 74,6
		20,3	4853	2,12	MR 3I 180 - 42 x 350 160 L	6 44,2
		19,3	5119	2,8	MR 3I 200 - 42 x 350 160 M	4 72,6
		22,6	4370	1,06	MR 3I 140 - 38 x 300 132 MC	4 62
		22,1	4477	1,5	MR 3I 160 - 38 x 300 132 MC	4 63,5
		22,1	4477	1,5	MR 3I 160 - 42 x 350 160 M	4 63,5
		21,9	4499	2,12	MR 3I 180 - 38 x 300 132 MC	4 63,8
		21,9	4499	2,12	MR 3I 180 - 42 x 350 160 M	4 63,8
		25,3	3904	1,18	MR 3I 140 - 38 x 300 132 MC	4 55,4
		25,2	3916	1,9	MR 3I 160 - 38 x 300 132 MC	4 55,5
		25,2	3916	1,9	MR 3I 160 - 42 x 350 160 M	4 55,5
	25,3	3899	2,24	MR 3I 180 - 42 x 350 160 M	4 55,3	
	27,8	3558	1,32	MR 3I 140 - 38 x 300 132 MC	4 50,4	
	27,6	3582	1,9	MR 3I 160 - 38 x 300 132 MC	4 50,8	
	27,6	3582	1,9	MR 3I 160 - 42 x 350 160 M	4 50,8	
	27,4	3600	2,5	MR 3I 180 - 42 x 350 160 M	4 51	
	31,1	3179	1,5	MR 3I 140 - 38 x 300 132 MC	4 45,1	
	31,5	3133	2,36	MR 3I 160 - 38 x 300 132 MC	4 44,4	
	31,5	3133	2,36	MR 3I 160 - 42 x 350 160 M	4 44,4	
	35,8	2760	1,12	MR 3I 125 - 38 x 300 132 MC	4 39,1	
	37,4	2699	0,95	MR 2I 125 - 42 x 350 160 L	6 24,1	
	36,2	2727	1,7	MR 3I 140 - 38 x 300 132 MC	4 38,7	
	37,4	2699	1,32	MR 2I 140 - 42 x 350 160 L	6 24,1	
	36,4	2715	2,8	MR 3I 160 - 42 x 350 160 M	4 38,5	
	36,6	2758	2,12	MR 2I 160 - 42 x 350 160 L	6 24,6	
	37,3	2647	1,8	MR 3I 140 - 38 x 300 132 MC	4 37,5	
	41,5	2430	1,6	MR 2I 140 - 42 x 350 160 L	6 21,7	
	38,4	2573	2,8	MR 3I 160 - 42 x 350 160 M	4 36,5	
	40	2521	2,5	MR 2I 160 - 42 x 350 160 L	6 22,5	
	43,6	2267	1,5	MR 3I 125 - 38 x 300 132 MC	4 32,1	
	46,7	2160	1,4	MR 2I 125 - 42 x 350 160 L	6 19,3	
	43,5	2271	1,9	MR 3I 140 - 38 x 300 132 MC	4 32,2	
	45,8	2201	1,9	MR 2I 140 - 42 x 350 160 L	6 19,6	
	44,3	2230	3,35	MR 3I 160 - 42 x 350 160 M	4 31,6	
43,5	2316	3	MR 2I 160 - 42 x 350 160 L	6 20,7		
48,1	2052	1,9	MR 3I 140 - 38 x 300 132 MC	4 29,1		
51,3	1967	2,12	MR 2I 140 - 42 x 350 160 L	6 17,6		
49,3	2002	3,35	MR 3I 160 - 42 x 350 160 M	4 28,4		
52,8	1871	1,6	MR 3I 125 - 38 x 300 132 MC	4 26,5		
58,1	1735	1,5	MR 2I 125 - 38 x 300 132 MC	4 24,1		
58,1	1735	1,5	MR 2I 125 - 42 x 350 160 M	4 24,1		
56,8	1774	1,6	MR 2I 125 - 42 x 350 160 L	6 15,8		
58,1	1735	2	MR 2I 140 - 38 x 300 132 MC	4 24,1		
58,1	1735	2	MR 2I 140 - 42 x 350 160 M	4 24,1		
64,6	1562	2,36	MR 2I 140 - 38 x 300 132 MC	4 21,7		
64,6	1562	2,36	MR 2I 140 - 42 x 350 160 M	4 21,7		
72,5	1391	1,12	MR 2I 100 - 38 x 300 132 MC	4 19,3		
64,2	1537	2,24	MR 3I 125 - 38 x 300 132 MC	4 21,8		
72,6	1388	2	MR 2I 125 - 38 x 300 132 MC	4 19,3		
72,6	1388	2	MR 2I 125 - 42 x 350 160 M	4 19,3		
71,3	1415	2,8	MR 2I 140 - 38 x 300 132 MC	4 19,6		
71,3	1415	2,8	MR 2I 140 - 42 x 350 160 M	4 19,6		
87,1	1158	1,25	MR 2I 100 - 38 x 300 132 MC	4 16,1		
88,4	1140	2,36	MR 2I 125 - 38 x 300 132 MC	4 15,8		
88,4	1140	2,36	MR 2I 125 - 42 x 350 160 M	4 15,8		

1) Powers valid for continuous duty S1; **increase possible** for duty cycles S2 ... S10 (see ch. 1 «General specifications»); in which case M_2 increases and f_s decreases.

2) For complete designation when ordering see ch. 2.

11 - Selection tables (helical gearmotors)

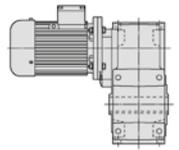

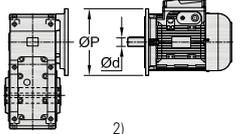
P_1 kW	n_2 min ⁻¹	M_2 N m	f_s		i			
1)				2)				
11	114	885	1,7	MR 2I 100 - 38 × 300	132 MC	4	12,3	
	107	941	2,8	MR 2I 125 - 38 × 300	132 MC	4	13,1	
	107	941	2,8	MR 2I 125 - 42 × 350	160 M	4	13,1	
	137	737	1,8	MR 2I 100 - 38 × 300	132 MC	4	10,2	
	130	773	3,55	MR 2I 125 - 38 × 300	132 MC	4	10,7	
	130	773	3,55	MR 2I 125 - 42 × 350	160 M	4	10,7	
	175	577	2,36	MR 2I 100 - 38 × 300	132 MC	4	8,01	
	169	595	4,5	MR 2I 125 - 38 × 300	132 MC	4	8,26	
	169	595	4,5	MR 2I 125 - 42 × 350	160 M	4	8,26	
	218	462	2,65	MR 2I 100 - 38 × 300	132 MC	4	6,42	
	214	471	5	MR 2I 125 - 38 × 300	132 MC	4	6,53	
	214	471	5	MR 2I 125 - 42 × 350	160 M	4	6,53	
	15	7,2	18698	1,4	MR 3I 250 - 48 × 350	180 L	6	125
		7,31	18414	2	MR 3I 280 - 48 × 350	180 L	6	123
9		14969	1	MR 3I 200 - 48 × 350	180 L	6	100	
9,13		14745	1,5	MR 3I 225 - 48 × 350	180 L	6	98,5	
9,14		14731	2,12	MR 3I 250 - 48 × 350	180 L	6	98,5	
8,97		15015	2,65	MR 3I 280 - 48 × 350	180 L	6	100	
10,4		12934	1,25	MR 3I 200 - 48 × 350	180 L	6	86,4	
10,1		13279	1,6	MR 3I 225 - 48 × 350	180 L	6	88,8	
10,1		13315	2,36	MR 3I 250 - 48 × 350	180 L	6	89	
10		13416	3,15	MR 3I 280 - 48 × 350	180 L	6	89,7	
11,7		11461	1,06	MR 3I 200 - 42 × 350	160 L	4	119	
10,7		12568	1,18	MR 3I 200 - 48 × 350	180 L	6	84	
11,4		11807	1,5	MR 3I 225 - 42 × 350	160 L	4	123	
11,2		12020	2,12	MR 3I 250 - 42 × 350	160 L	4	125	
10,9		12368	2,36	MR 3I 250 - 48 × 350	180 L	6	82,7	
11,4		11838	2,8	MR 3I 280 - 42 × 350	160 L	4	123	
14,1		9544	1	MR 3I 180 - 48 × 350	180 L	6	63,8	
14		9623	1,5	MR 3I 200 - 42 × 350	160 L	4	100	
14,2		9479	2,12	MR 3I 225 - 42 × 350	160 L	4	98,5	
14,2		9470	3	MR 3I 250 - 42 × 350	160 L	4	98,5	
16,3		8272	1,06	MR 3I 180 - 48 × 350	180 L	6	55,3	
16,2		8315	1,8	MR 3I 200 - 42 × 350	160 L	4	86,4	
15,8		8536	2,5	MR 3I 225 - 42 × 350	160 L	4	88,8	
18		7491	1,12	MR 3I 180 - 42 × 350	160 L	4	77,9	
16,7		8079	1,7	MR 3I 200 - 42 × 350	160 L	4	84	
16,9		7958	2,5	MR 3I 225 - 42 × 350	160 L	4	82,7	
20,3		6646	1,12	MR 3I 160 - 48 × 350	180 L	6	44,4	
20,3		6617	1,6	MR 3I 180 - 48 × 350	180 L	6	44,2	
19,3		6981	2,12	MR 3I 200 - 42 × 350	160 L	4	72,6	
18,8		7167	2,8	MR 3I 225 - 42 × 350	160 L	4	74,5	
22,1		6105	1,12	MR 3I 160 - 42 × 350	160 L	4	63,5	
21,9		6136	1,5	MR 3I 180 - 42 × 350	160 L	4	63,8	
22,4		6022	2,24	MR 3I 200 - 42 × 350	160 L	4	62,6	
25,2		5340	1,4	MR 3I 160 - 42 × 350	160 L	4	55,5	
25,3		5317	1,7	MR 3I 180 - 42 × 350	160 L	4	55,3	
25,9		5203	2,8	MR 3I 200 - 42 × 350	160 L	4	54,1	
27,8		4852	0,95	MR 3I 140 - 38 × 300	160 L	4	50,4	
27,6		4884	1,4	MR 3I 160 - 42 × 350	160 L	4	50,8	
27,4		4908	1,9	MR 3I 180 - 42 × 350	160 L	4	51	
26,6		5056	2,65	MR 3I 200 - 42 × 350	160 L	4	52,6	
31,1		4335	1,12	MR 3I 140 - 38 × 300	160 L	4	45,1	
31,5		4272	1,7	MR 3I 160 - 42 × 350	160 L	4	44,4	
31,7		4254	2,36	MR 3I 180 - 42 × 350	160 L	4	44,2	
36,2		3719	1,25	MR 3I 140 - 38 × 300	160 L	4	38,7	
37,4		3681	1	MR 2I 140 - 48 × 350	180 L	6	24,1	
36,4		3703	2	MR 3I 160 - 42 × 350	160 L	4	38,5	
36,6		3761	1,5	MR 2I 160 - 48 × 350	180 L	6	24,6	
35,1		3840	2,5	MR 3I 180 - 42 × 350	160 L	4	39,9	
35,5		3875	2,12	MR 2I 180 - 48 × 350	180 L	6	25,4	
37,3		3610	1,32	MR 3I 140 - 38 × 300	160 L	4	37,5	
41,5	3313	1,18	MR 2I 140 - 48 × 350	180 L	6	21,7		
38,4	3509	2,12	MR 3I 160 - 42 × 350	160 L	4	36,5		
40	3438	1,9	MR 2I 160 - 48 × 350	180 L	6	22,5		
38,5	3494	2,8	MR 3I 180 - 42 × 350	160 L	4	36,3		
38,6	3565	2,5	MR 2I 180 - 48 × 350	180 L	6	23,3		

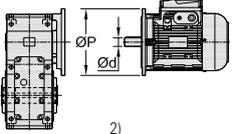
P_1 kW	n_2 min ⁻¹	M_2 N m	f_s		i		
1)				2)			
15	43,5	3097	1,4	MR 3I 140 - 38 × 300	160 L	* 4	32,2
	45,8	3002	1,4	MR 2I 140 - 48 × 350	180 L	6	19,6
	44,3	3041	2,5	MR 3I 160 - 42 × 350	160 L	4	31,6
	43,5	3158	2,12	MR 2I 160 - 48 × 350	180 L	6	20,7
	42,7	3155	3,35	MR 3I 180 - 42 × 350	160 L	4	32,8
	43,3	3174	2,8	MR 2I 180 - 48 × 350	180 L	6	20,8
	48,1	2798	1,4	MR 3I 140 - 38 × 300	160 L	* 4	29,1
	51,3	2682	1,6	MR 2I 140 - 48 × 350	180 L	6	17,6
	49,3	2730	2,5	MR 3I 160 - 42 × 350	160 L	4	28,4
	49,8	2762	2,65	MR 2I 160 - 48 × 350	180 L	6	18,1
	58,1	2366	1,06	MR 2I 125 - 42 × 350	160 L	4	24,1
	58,1	2366	1,5	MR 2I 140 - 42 × 350	160 L	4	24,1
	56,9	2418	2,36	MR 2I 160 - 42 × 350	160 L	4	24,6
	64,6	2130	1,8	MR 2I 140 - 42 × 350	160 L	4	21,7
	62,2	2210	2,8	MR 2I 160 - 42 × 350	160 L	4	22,5
	72,6	1893	1,4	MR 2I 125 - 42 × 350	160 L	4	19,3
	71,3	1930	2,12	MR 2I 140 - 42 × 350	160 L	4	19,6
	67,7	2030	3,35	MR 2I 160 - 42 × 350	160 L	4	20,7
	79,8	1724	2,36	MR 2I 140 - 42 × 350	160 L	4	17,6
	77,4	1776	4	MR 2I 160 - 42 × 350	160 L	4	18,1
	88,4	1555	1,8	MR 2I 125 - 42 × 350	160 L	4	15,8
	93	1479	2,8	MR 2I 140 - 42 × 350	160 L	4	15,1
	95,2	1444	2,65	MR 2I 140 - 42 × 350	160 L	4	14,7
	107	1284	2,12	MR 2I 125 - 42 × 350	160 L	4	13,1
	105	1308	3	MR 2I 140 - 42 × 350	160 L	4	13,3
	118	1169	3,55	MR 2I 140 - 42 × 350	160 L	4	11,9
	130	1054	2,5	MR 2I 125 - 42 × 350	160 L	4	10,7
137	1003	3,75	MR 2I 140 - 42 × 350	160 L	4	10,2	
169	812	3,35	MR 2I 125 - 42 × 350	160 L	4	8,26	
214	642	3,75	MR 2I 125 - 42 × 350	160 L	4	6,53	
18,5	7,2	23060	1,18	MR 3I 250 - 55 × 400	200 LR	6	125
	7,31	22711	1,6	MR 3I 280 - 55 × 400	200 LR	6	123
	7,1	23390	1,9	MR 3I 320 - 55 × 400	200 LR	6	127
	7,1	23390	2,36	MR 3I 321 - 55 × 400	200 LR	6	127
	9,14	18169	1,7	MR 3I 250 - 55 × 400	200 LR	6	98,5
	8,97	18518	2,12	MR 3I 280 - 55 × 400	200 LR	6	100
	10,1	16422	1,9	MR 3I 250 - 55 × 400	200 LR	6	89
	10	16547	2,5	MR 3I 280 - 55 × 400	200 LR	6	89,7
	11,4	14562	1,18	MR 3I 225 - 48 × 350	180 M	4	123
	11,2	14825	1,7	MR 3I 250 - 48 × 350	180 M	4	125
	11,4	14600	2,36	MR 3I 280 - 48 × 350	180 M	4	123
	14	11868	1,18	MR 3I 200 - 48 × 350	180 M	4	100
	14,2	11690	1,7	MR 3I 225 - 48 × 350	180 M	4	98,5
	14,2	11680	2,5	MR 3I 250 - 48 × 350	180 M	4	98,5
	16,2	10255	1,5	MR 3I 200 - 48 × 350	180 M	4	86,4
	15,8	10528	2	MR 3I 225 - 48 × 350	180 M	4	88,8
	15,7	10557	2,8	MR 3I 250 - 48 × 350	180 M	4	89
	16,7	9964	1,4	MR 3I 200 - 48 × 350	180 M	4	84
	16,9	9815	2	MR 3I 225 - 48 × 350	180 M	4	82,7
	16,9	9806	2,8	MR 3I 250 - 48 × 350	180 M	4	82,7
	19,3	8610	1,7	MR 3I 200 - 48 × 350	180 M	4	72,6
	18,8	8839	2,36	MR 3I 225 - 48 × 350	180 M	4	74,5
	21,9	7567	1,25	MR 3I 180 - 48 × 350	180 M	4	63,8
	22,4	7427	1,8	MR 3I 200 - 48 × 350	180 M	4	62,6
	22,7	7316	2,65	MR 3I 225 - 48 × 350	180 M	4	61,7
	25,2	6586	1,12	MR 3I 160 - 48 × 350	180 M	4	55,5
	25,3	6558	1,32	MR 3I 180 - 48 × 350	180 M	4	55,3
25,9	6418	2,24	MR 3I 200 - 48 × 350	180 M	4	54,1	
25,2	6589	3,15	MR 3I 225 - 48 × 350				

11 - Selection tables (helical gearmotors)

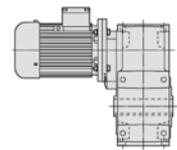

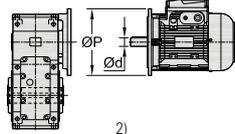
P_1 kW	n_2 min ⁻¹	M_2 N m	f_s		i
1)				2)	
18,5	31,5	5269	1,4	MR 3I 160 - 48 × 350 180 M	4 44,4
	31,7	5247	1,9	MR 3I 180 - 48 × 350 180 M	4 44,2
	30,8	5388	2,65	MR 3I 200 - 48 × 350 180 M	4 45,4
	36,4	4566	1,7	MR 3I 160 - 48 × 350 180 M	4 38,5
	35,1	4737	2	MR 3I 180 - 48 × 350 180 M	4 39,9
	33,7	4928	3	MR 3I 200 - 48 × 350 180 M	4 41,5
	38,4	4328	1,7	MR 3I 160 - 48 × 350 180 M	4 36,5
	38,5	4310	2,36	MR 3I 180 - 48 × 350 180 M	4 36,3
	44,3	3751	2	MR 3I 160 - 48 × 350 180 M	4 31,6
	42,7	3891	2,65	MR 3I 180 - 48 × 350 180 M	4 32,8
	49,3	3367	2	MR 3I 160 - 48 × 350 180 M	4 28,4
	49	3392	2,24	MR 3I 180 - 48 × 350 180 M	4 28,6
	58,1	2919	0,9	MR 2I 125 - 48 × 350 180 M	4 24,1
	58,1	2919	1,18	MR 2I 140 - 48 × 350 180 M	4 24,1
	56,9	2982	1,9	MR 2I 160 - 48 × 350 180 M	4 24,6
	55,2	3072	2,65	MR 2I 180 - 48 × 350 180 M	4 25,4
	64,6	2627	1,4	MR 2I 140 - 48 × 350 180 M	4 21,7
	62,2	2726	2,36	MR 2I 160 - 48 × 350 180 M	4 22,5
	60	2827	3,15	MR 2I 180 - 48 × 350 180 M	4 23,3
	72,6	2335	1,18	MR 2I 125 - 48 × 350 180 M	4 19,3
	71,3	2380	1,7	MR 2I 140 - 48 × 350 180 M	4 19,6
67,7	2504	2,65	MR 2I 160 - 48 × 350 180 M	4 20,7	
79,8	2126	1,9	MR 2I 140 - 48 × 350 180 M	4 17,6	
77,4	2190	3,35	MR 2I 160 - 48 × 350 180 M	4 18,1	
88,4	1918	1,4	MR 2I 125 - 48 × 350 180 M	4 15,8	
93	1824	2,24	MR 2I 140 - 48 × 350 180 M	4 15,1	
89,4	1898	3,55	MR 2I 160 - 48 × 350 180 M	4 15,7	
95,2	1781	2,24	MR 2I 140 - 48 × 350 180 M	4 14,7	
99,6	1704	3,55	MR 2I 160 - 48 × 350 180 M	4 14,1	
107	1583	1,7	MR 2I 125 - 48 × 350 180 M	4 13,1	
105	1613	2,5	MR 2I 140 - 48 × 350 180 M	4 13,3	
103	1645	4	MR 2I 160 - 48 × 350 180 M	4 13,6	
118	1442	2,8	MR 2I 140 - 48 × 350 180 M	4 11,9	
118	1439	5	MR 2I 160 - 48 × 350 180 M	4 11,9	
130	1300	2	MR 2I 125 - 48 × 350 180 M	4 10,7	
137	1237	3,15	MR 2I 140 - 48 × 350 180 M	4 10,2	
136	1247	5,6	MR 2I 160 - 48 × 350 180 M	4 10,3	
169	1001	2,65	MR 2I 125 - 48 × 350 180 M	4 8,26	
214	792	3	MR 2I 125 - 48 × 350 180 M	4 6,53	
22	7,31	27008	1,32	MR 3I 280 - 55 × 400 200 L	6 123
	7,1	27815	1,6	MR 3I 320 - 55 × 400 200 L	6 127
	7,1	27815	2	MR 3I 321 - 55 × 400 200 L	6 127
	6,89	28653	2,65	MR 3I 360 - 55 × 400 200 L	6 131
	9,14	21606	1,4	MR 3I 250 - 55 × 400 200 L	6 98,5
	8,97	22022	1,8	MR 3I 280 - 55 × 400 200 L	6 100
	8,6	22976	2,24	MR 3I 320 - 55 × 400 200 L	6 105
	10,1	19529	1,6	MR 3I 250 - 55 × 400 200 L	6 89
	10	19677	2,12	MR 3I 280 - 55 × 400 200 L	6 89,7
	9,99	19775	2,5	MR 3I 320 - 55 × 400 200 L	6 90,1
	11,4	17317	1	MR 3I 225 - 48 × 350 180 L	4 123
	11,2	17629	1,4	MR 3I 250 - 48 × 350 180 L	4 125
	11,4	17362	1,9	MR 3I 280 - 48 × 350 180 L	4 123
	14	14113	1	MR 3I 200 - 48 × 350 180 L	4 100
	14,2	13902	1,5	MR 3I 225 - 48 × 350 180 L	4 98,5
	14,2	13890	2	MR 3I 250 - 48 × 350 180 L	4 98,5
	14	14157	2,65	MR 3I 280 - 48 × 350 180 L	4 100
	16,2	12195	1,25	MR 3I 200 - 48 × 350 180 L	4 86,4
	15,8	12520	1,7	MR 3I 225 - 48 × 350 180 L	4 88,8
	15,7	12554	2,36	MR 3I 250 - 48 × 350 180 L	4 89
	16,7	11849	1,18	MR 3I 200 - 48 × 350 180 L	4 84
16,9	11672	1,7	MR 3I 225 - 48 × 350 180 L	4 82,7	
16,9	11662	2,36	MR 3I 250 - 48 × 350 180 L	4 82,7	
19,3	10239	1,4	MR 3I 200 - 48 × 350 180 L	4 72,6	
18,8	10512	2	MR 3I 225 - 48 × 350 180 L	4 74,5	
18,7	10540	2,65	MR 3I 250 - 48 × 350 180 L	4 74,7	

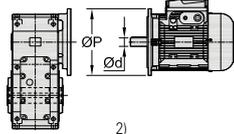
P_1 kW	n_2 min ⁻¹	M_2 N m	f_s		i
1)				2)	
22	21,9	8999	1,06	MR 3I 180 - 48 × 350 180 L	4 63,8
	22,4	8832	1,6	MR 3I 200 - 48 × 350 180 L	4 62,6
	22,7	8700	2,24	MR 3I 225 - 48 × 350 180 L	4 61,7
	25,3	7799	1,12	MR 3I 180 - 48 × 350 180 L	4 55,3
	25,9	7632	1,9	MR 3I 200 - 48 × 350 180 L	4 54,1
	25,2	7835	2,65	MR 3I 225 - 48 × 350 180 L	4 55,5
	27,6	7164	0,95	MR 3I 160 - 48 × 350 180 L	4 50,8
	27,4	7199	1,32	MR 3I 180 - 48 × 350 180 L	4 51
	26,6	7416	1,8	MR 3I 200 - 48 × 350 180 L	4 52,6
	27	7304	2,65	MR 3I 225 - 48 × 350 180 L	4 51,8
	31,5	6266	1,18	MR 3I 160 - 48 × 350 180 L	4 44,4
	31,7	6239	1,6	MR 3I 180 - 48 × 350 180 L	4 44,2
	30,8	6407	2,24	MR 3I 200 - 48 × 350 180 L	4 45,4
	36,4	5430	1,4	MR 3I 160 - 48 × 350 180 L	4 38,5
	36,6	5516	1,06	MR 2I 160 - 55 × 400 200 L	6 24,6
	35,1	5633	1,7	MR 3I 180 - 48 × 350 180 L	4 39,9
	35,5	5683	1,5	MR 2I 180 - 55 × 400 200 L	6 25,4
	33,7	5861	2,5	MR 3I 200 - 48 × 350 180 L	4 41,5
	37,1	5432	2,12	MR 2I 200 - 55 × 400 200 L	6 24,2
	38,4	5147	1,4	MR 3I 160 - 48 × 350 180 L	4 36,5
	40	5042	1,32	MR 2I 160 - 55 × 400 200 L	6 22,5
38,5	5125	2	MR 3I 180 - 48 × 350 180 L	4 36,3	
38,6	5229	1,7	MR 2I 180 - 55 × 400 200 L	6 23,3	
40,7	4857	3	MR 3I 200 - 48 × 350 180 L	4 34,4	
40,6	4965	2,5	MR 2I 200 - 55 × 400 200 L	6 22,2	
44,3	4461	1,7	MR 3I 160 - 48 × 350 180 L	4 31,6	
43,5	4632	1,5	MR 2I 160 - 55 × 400 200 L	6 20,7	
42,7	4627	2,24	MR 3I 180 - 48 × 350 180 L	4 32,8	
43,3	4655	2	MR 2I 180 - 55 × 400 200 L	6 20,8	
44,5	4443	3,35	MR 3I 200 - 48 × 350 180 L	4 31,5	
44,2	4560	3	MR 2I 200 - 55 × 400 200 L	6 20,3	
49,3	4004	1,7	MR 3I 160 - 48 × 350 180 L	4 28,4	
49,8	4051	1,8	MR 2I 160 - 55 × 400 200 L	6 18,1	
49	4034	1,8	MR 3I 180 - 48 × 350 180 L	4 28,6	
50	4034	2	MR 2I 180 - 55 × 400 200 L	6 18	
51,4	3840	4	MR 3I 200 - 48 × 350 180 L	4 27,2	
58,1	3471	1	MR 2I 140 - 48 × 350 180 L	4 24,1	
56,9	3546	1,6	MR 2I 160 - 48 × 350 180 L	4 24,6	
57,4	3511	2	MR 2I 160 - 55 × 400 200 L	6 15,7	
55,2	3653	2,24	MR 2I 180 - 48 × 350 180 L	4 25,4	
64,6	3124	1,18	MR 2I 140 - 48 × 350 180 L	4 21,7	
62,2	3242	2	MR 2I 160 - 48 × 350 180 L	4 22,5	
60	3362	2,65	MR 2I 180 - 48 × 350 180 L	4 23,3	
72,6	2777	1	MR 2I 125 - 48 × 350 180 L	4 19,3	
71,3	2830	1,4	MR 2I 140 - 48 × 350 180 L	4 19,6	
67,7	2977	2,24	MR 2I 160 - 48 × 350 180 L	4 20,7	
79,8	2529	1,6	MR 2I 140 - 48 × 350 180 L	4 17,6	
77,4	2604	2,8	MR 2I 160 - 48 × 350 180 L	4 18,1	
88,4	2281	1,18	MR 2I 125 - 48 × 350 180 L	4 15,8	
93	2169	1,9	MR 2I 140 - 48 × 350 180 L	4 15,1	
89,4	2257	3	MR 2I 160 - 48 × 350 180 L	4 15,7	
95,2	2118	1,9	MR 2I 140 - 48 × 350 180 L	4 14,7	
99,6	2026	3	MR 2I 160 - 48 × 350 180 L	4 14,1	
107	1882	1,4	MR 2I 125 - 48 × 350 180 L	4 13,1	
105	1919	2	MR 2I 140 - 48 × 350 180 L	4 13,3	
103	1957	3,35	MR 2I 160 - 48 × 350 180 L	4 13,6	
118	1714	2,36	MR 2I 140 - 48 × 350 180 L	4 11,9	
118	1711	4,25	MR 2I 160 - 48 × 350 180 L	4 11,9	
130	1546	1,7	MR 2I 125 - 48 × 350 180 L	4 10,7	
137	1471	2,65	MR 2I 140 - 48 × 350 180 L	4 10,2	
136	1483	4,75	MR 2I 160 - 48 × 350 180 L	4 10,3	
152	1329	2,65	MR 2I 140 - 48 × 350 180 L	4 9,22	
151	1331	4,75	MR 2I 160 - 48 × 350 180 L	4 9,24	
169	1190	2,24	MR 2I 125 - 48 × 350 180 L	4 8,26	
214	941	2,5	MR 2I 125 - 48 × 350 180 L	4 6,53	

1) Powers valid for continuous duty S1; **increase possible** for duty cycles S2 ... S10 (see ch. 1 «General specifications»); in which case M_2 increases and f_s decreases.
 2) For complete designation when ordering see ch. 2.

11 - Selection tables (helical garmotors)

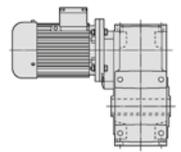

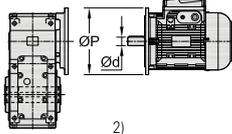
P_1 kW	n_2 min ⁻¹	M_2 N m	f_s		i
1)				2)	
30	7,1	37930	1,18	MR 3I 320 - 60 × 450 225 M	6 127
	7,1	37930	1,5	MR 3I 321 - 60 × 450 225 M	6 127
	6,89	39072	1,9	MR 3I 360 - 60 × 450 225 M	6 131
	9,14	29463	1,06	MR 3I 250 - 60 × 450 225 M	6 98,5
	8,97	30030	1,32	MR 3I 280 - 60 × 450 225 M	6 100
	8,6	31331	1,7	MR 3I 320 - 60 × 450 225 M	6 105
	8,6	31331	2,12	MR 3I 321 - 60 × 450 225 M	6 105
	8,74	30818	2,8	MR 3I 360 - 60 × 450 225 M	6 103
	10,1	26630	1,18	MR 3I 250 - 60 × 450 225 M	6 89
	10	26832	1,6	MR 3I 280 - 60 × 450 225 M	6 89,7
	9,99	24966	1,8	MR 3I 320 - 60 × 450 225 M	6 90,1
	9,99	26966	2,24	MR 3I 321 - 60 × 450 225 M	6 90,1
	9,71	27736	3	MR 3I 360 - 60 × 450 225 M	6 92,7
	11,2	24040	1,06	MR 3I 250 - 55 × 400 200 L	4 125
	10,9	24737	1,18	MR 3I 250 - 60 × 450 225 M	6 82,7
	11,4	23676	1,4	MR 3I 280 - 55 × 400 200 L	4 123
	11	24383	1,7	MR 3I 320 - 55 × 400 200 L	4 127
	11	24383	2,12	MR 3I 321 - 55 × 400 200 L	4 127
	10,9	24685	2,12	MR 3I 320 - 60 × 450 225 M	6 82,5
	10,9	24685	2,65	MR 3I 321 - 60 × 450 225 M	6 82,5
	10,7	25118	3	MR 3I 360 - 55 × 400 200 L	4 131
	14,6	18455	1,06	MR 3I 225 - 60 × 450 225 M	6 61,7
	14,2	18940	1,5	MR 3I 250 - 55 × 400 200 L	4 98,5
	14	19305	1,9	MR 3I 280 - 55 × 400 200 L	4 100
	13,4	20142	2,5	MR 3I 320 - 55 × 400 200 L	4 105
	16,2	16620	1,25	MR 3I 225 - 60 × 450 225 M	6 55,5
	15,7	17119	1,7	MR 3I 250 - 55 × 400 200 L	4 89
	15,6	17249	2,36	MR 3I 280 - 55 × 400 200 L	4 89,7
	18,2	14778	1,12	MR 3I 225 - 55 × 400 200 L	4 76,8
	16,9	15902	1,7	MR 3I 250 - 55 × 400 200 L	4 82,7
	16,6	16208	2,24	MR 3I 280 - 55 × 400 200 L	4 84,3
	19,8	13592	1,06	MR 3I 200 - 60 × 450 225 M	6 45,4
	19,3	13954	1,5	MR 3I 225 - 60 × 450 225 M	6 46,6
	18,7	14373	2	MR 3I 250 - 55 × 400 200 L	4 74,7
	18,6	14482	2,8	MR 3I 280 - 55 × 400 200 L	4 75,3
	22,4	12044	1,12	MR 3I 200 - 55 × 400 200 L	4 62,6
	22,7	11864	1,6	MR 3I 225 - 55 × 400 200 L	4 61,7
	22,8	11838	2,36	MR 3I 250 - 55 × 400 200 L	4 61,5
	25,9	10407	1,4	MR 3I 200 - 55 × 400 200 L	4 54,1
	25,2	10684	1,9	MR 3I 225 - 55 × 400 200 L	4 55,5
	25,2	10700	2,65	MR 3I 250 - 55 × 400 200 L	4 55,6
	27,4	9817	0,95	MR 3I 180 - 48 × 350 200 L	* 4 51
	26,6	10112	1,32	MR 3I 200 - 55 × 400 200 L	4 52,6
	27	9961	2	MR 3I 225 - 55 × 400 200 L	4 51,8
	27,1	9939	2,8	MR 3I 250 - 55 × 400 200 L	4 51,7
	31,7	8508	1,18	MR 3I 180 - 48 × 350 200 L	* 4 44,2
	30,8	8737	1,7	MR 3I 200 - 55 × 400 200 L	4 45,4
	30	8970	2,24	MR 3I 225 - 55 × 400 200 L	4 46,6
	35,1	7681	1,25	MR 3I 180 - 48 × 350 200 L	* 4 39,9
	33,7	7992	1,9	MR 3I 200 - 55 × 400 200 L	4 41,5
	34,7	7771	2,65	MR 3I 225 - 55 × 400 200 L	4 40,4
	38,5	6989	1,4	MR 3I 180 - 48 × 350 200 L	* 4 36,3
	40,7	6624	2,12	MR 3I 200 - 55 × 400 200 L	4 34,4
	39,6	6800	3	MR 3I 225 - 55 × 400 200 L	4 35,4
	42,7	6309	1,7	MR 3I 180 - 48 × 350 200 L	* 4 32,8
	44,5	6058	2,5	MR 3I 200 - 55 × 400 200 L	4 31,5
	45,7	5891	3,55	MR 3I 225 - 55 × 400 200 L	4 30,6
	49	5500	1,32	MR 3I 180 - 48 × 350 200 L	* 4 28,6
51,4	5236	2,8	MR 3I 200 - 55 × 400 200 L	4 27,2	
56,9	4836	1,18	MR 2I 160 - 55 × 400 200 L	4 24,6	
55,2	4982	1,6	MR 2I 180 - 55 × 400 200 L	4 25,4	
57,8	4761	2,36	MR 2I 200 - 55 × 400 200 L	4 24,2	
62,2	4420	1,4	MR 2I 160 - 55 × 400 200 L	4 22,5	
60	4584	2	MR 2I 180 - 55 × 400 200 L	4 23,3	
63,2	4352	2,8	MR 2I 200 - 55 × 400 200 L	4 22,2	

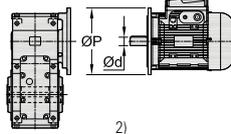
P_1 kW	n_2 min ⁻¹	M_2 N m	f_s		i	
1)				2)		
30	67,7	4060	1,6	MR 2I 160 - 55 × 400 200 L	4 20,7	
	67,4	4080	2,24	MR 2I 180 - 55 × 400 200 L	4 20,8	
	68,8	3998	3,35	MR 2I 200 - 55 × 400 200 L	4 20,3	
	77,4	3551	2	MR 2I 160 - 55 × 400 200 L	4 18,1	
	77,8	3536	2,24	MR 2I 180 - 55 × 400 200 L	4 18	
	89,4	3078	2,24	MR 2I 160 - 55 × 400 200 L	4 15,7	
	86,2	3192	2,24	MR 2I 180 - 55 × 400 200 L	4 16,3	
	95,2	2888	1,32	MR 2I 140 - 48 × 350 200 L	* 4 14,7	
	99,6	2763	2,24	MR 2I 160 - 55 × 400 200 L	4 14,1	
	97,2	2829	3	MR 2I 180 - 55 × 400 200 L	4 14,4	
	105	2616	1,5	MR 2I 140 - 48 × 350 200 L	* 4 13,3	
	103	2668	2,5	MR 2I 160 - 55 × 400 200 L	4 13,6	
	103	2681	3,35	MR 2I 180 - 55 × 400 200 L	4 13,6	
	118	2338	1,7	MR 2I 140 - 48 × 350 200 L	* 4 11,9	
	118	2334	3	MR 2I 160 - 55 × 400 200 L	4 11,9	
	118	2324	3,75	MR 2I 180 - 55 × 400 200 L	4 11,8	
	137	2006	1,9	MR 2I 140 - 48 × 350 200 L	* 4 10,2	
	136	2023	3,55	MR 2I 160 - 55 × 400 200 L	4 10,3	
	131	2098	3,75	MR 2I 180 - 55 × 400 200 L	4 10,7	
	152	1812	1,9	MR 2I 140 - 48 × 350 200 L	* 4 9,22	
	151	1815	3,55	MR 2I 160 - 55 × 400 200 L	4 9,24	
	150	1829	3,75	MR 2I 180 - 55 × 400 200 L	4 9,31	
	174	1578	3,75	MR 2I 160 - 55 × 400 200 L	4 8,03	
	218	1260	3,75	MR 2I 160 - 55 × 400 200 L	4 6,41	
	37	7,1	46780	1,18	MR 3I 321 - 65 × 550 250 M	6 127
		6,89	48189	1,6	MR 3I 360 - 65 × 550 250 M	6 131
		8,6	38642	1,4	MR 3I 320 - 65 × 550 250 M	6 105
		8,6	38642	1,7	MR 3I 321 - 65 × 550 250 M	6 105
		8,74	38009	2,24	MR 3I 360 - 65 × 550 250 M	6 103
		9,99	33257	1,5	MR 3I 320 - 65 × 550 250 M	6 90,1
		9,99	33257	1,9	MR 3I 321 - 65 × 550 250 M	6 90,1
		9,71	34208	2,36	MR 3I 360 - 65 × 550 250 M	6 92,7
		11,4	29200	1,18	MR 3I 280 - 60 × 450 225 S	4 123
		11	30073	1,4	MR 3I 320 - 60 × 450 225 S	4 127
11		30073	1,7	MR 3I 321 - 60 × 450 225 S	4 127	
10,9		30445	1,7	MR 3I 320 - 65 × 550 250 M	6 82,5	
10,9		30445	2,12	MR 3I 321 - 65 × 550 250 M	6 82,5	
10,7		30979	2,36	MR 3I 360 - 60 × 450 225 S	4 131	
14,2		23360	1,18	MR 3I 250 - 60 × 450 225 S	4 98,5	
14		23809	1,5	MR 3I 280 - 60 × 450 225 S	4 100	
13,4		24841	2	MR 3I 320 - 60 × 450 225 S	4 105	
13,4		24841	2,5	MR 3I 321 - 60 × 450 225 S	4 105	
15,7		21114	1,4	MR 3I 250 - 60 × 450 225 S	4 89	
15,6		21274	1,9	MR 3I 280 - 60 × 450 225 S	4 89,7	
15,5		21380	2,12	MR 3I 320 - 60 × 450 225 S	4 90,1	
16,9		19613	1,4	MR 3I 250 - 60 × 450 225 S	4 82,7	
16,6		19990	1,8	MR 3I 280 - 60 × 450 225 S	4 84,3	
17		19572	2,5	MR 3I 320 - 60 × 450 225 S	4 82,5	
18,7		17727	1,6	MR 3I 250 - 60 × 450 225 S	4 74,7	
18,6		17861	2,24	MR 3I 280 - 60 × 450 225 S	4 75,3	
22,4		14855	0,9	MR 3I 200 - 60 × 450 225 S	4 62,6	
22,7		14632	1,32	MR 3I 225 - 60 × 450 225 S	4 61,7	
22,8		14600	1,9	MR 3I 250 - 60 × 450 225 S	4 61,5	
22,3		14881	2,36	MR 3I 280 - 60 × 450 225 S	4 62,7	
25,9		12835	1,12	MR 3I 200 - 60 × 450 225 S	4 54,1	
25,2		13177	1,6	MR 3I 225 - 60 × 450 225 S	4 55,5	
25,2		13196	2,12	MR 3I 250 - 60 × 450 225 S	4 55,6	
25		13296	3	MR 3I 280 - 60 × 450 225 S	4 56	
26,6	12472	1,12	MR 3I 200 - 60 × 450 225 S	4 52,6		
27	12285	1,6	MR 3I 225 - 60 × 450 225 S	4 51,8		
27,1	12258	2,24	MR 3I 250 - 60 × 450 225 S	4 51,7		
26,6	12494	2,8	MR 3I 280 - 60 × 450 225 S	4 52,7		

11

1) Powers valid for continuous duty S1; **increase possible** for duty cycles S2 ... S10 (see ch. 1 «General specifications»); in which case M_2 increases and f_s decreases.

2) For complete designation when ordering see ch. 2.

* Mounting position **B5R** (see ch. 1.2).

11 - Selection tables (helical gearmotors)

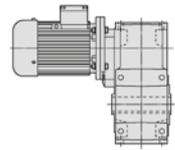

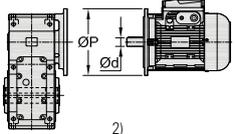
P_1 kW	n_2 min ⁻¹	M_2 N m	f_s		i	
1)				2)		
37	30,8	10776	1,32	MR 3I 200 - 60 × 450 225 S	4 45,4	
	30	11064	1,8	MR 3I 225 - 60 × 450 225 S	4 46,6	
	30	11079	2,5	MR 3I 250 - 60 × 450 225 S	4 46,7	
	33,7	9857	1,5	MR 3I 200 - 60 × 450 225 S	4 41,5	
	34,7	9584	2,12	MR 3I 225 - 60 × 450 225 S	4 40,4	
	33	10069	2,8	MR 3I 250 - 60 × 450 225 S	4 42,4	
	40,7	8169	1,8	MR 3I 200 - 60 × 450 225 S	4 34,4	
	39,6	8387	2,36	MR 3I 225 - 60 × 450 225 S	4 35,4	
	44,5	7472	2	MR 3I 200 - 60 × 450 225 S	4 31,5	
	45,7	7266	2,8	MR 3I 225 - 60 × 450 225 S	4 30,6	
	51,4	6458	2,36	MR 3I 200 - 60 × 450 225 S	4 27,2	
	51,3	6481	2,8	MR 3I 225 - 60 × 450 225 S	4 27,3	
	56,9	5964	0,95	MR 2I 160 - 60 × 450 225 S	4 24,6	
	55,2	6144	1,32	MR 2I 180 - 60 × 450 225 S	4 25,4	
	57,8	5872	1,9	MR 2I 200 - 60 × 450 225 S	4 24,2	
	56,1	6049	2,65	MR 2I 225 - 60 × 450 225 S	4 25	
	62,2	5452	1,18	MR 2I 160 - 60 × 450 225 S	4 22,5	
	60	5654	1,6	MR 2I 180 - 60 × 450 225 S	4 23,3	
	63,2	5368	2,24	MR 2I 200 - 60 × 450 225 S	4 22,2	
	67,7	5007	1,32	MR 2I 160 - 60 × 450 225 S	4 20,7	
	67,4	5032	1,8	MR 2I 180 - 60 × 450 225 S	4 20,8	
	68,8	4930	2,65	MR 2I 200 - 60 × 450 225 S	4 20,3	
	77,4	4380	1,6	MR 2I 160 - 60 × 450 225 S	4 18,1	
	77,8	4361	1,8	MR 2I 180 - 60 × 450 225 S	4 18	
	79,6	4260	3,35	MR 2I 200 - 60 × 450 225 S	4 17,6	
	89,4	3796	1,8	MR 2I 160 - 60 × 450 225 S	4 15,7	
	84,3	4026	2,24	MR 2I 180 - 60 × 450 225 S	4 16,6	
	87,1	3897	3,75	MR 2I 200 - 60 × 450 225 S	4 16,1	
	99,6	3407	1,8	MR 2I 160 - 60 × 450 225 S	4 14,1	
	97,2	3489	2,5	MR 2I 180 - 60 × 450 225 S	4 14,4	
	103	3291	2	MR 2I 160 - 60 × 450 225 S	4 13,6	
	103	3307	2,65	MR 2I 180 - 60 × 450 225 S	4 13,6	
	118	2878	2,5	MR 2I 160 - 60 × 450 225 S	4 11,9	
	118	2866	3	MR 2I 180 - 60 × 450 225 S	4 11,8	
	136	2495	2,8	MR 2I 160 - 60 × 450 225 S	4 10,3	
	131	2587	3,15	MR 2I 180 - 60 × 450 225 S	4 10,7	
	151	2239	2,8	MR 2I 160 - 60 × 450 225 S	4 9,24	
	174	1946	3,15	MR 2I 160 - 60 × 450 225 S	4 8,03	
	218	1554	3,15	MR 2I 160 - 60 × 450 225 S	4 6,41	
	45	6,89	58609	1,25	MR 3I 360 - 75 × 550 280 S	6 131
8,6		46997	1,12	MR 3I 320 - 75 × 550 280 S	6 105	
8,6		46997	1,4	MR 3I 321 - 75 × 550 280 S	6 105	
8,74		46227	1,9	MR 3I 360 - 75 × 550 280 S	6 103	
9,99		40448	1,25	MR 3I 320 - 75 × 550 280 S	6 90,1	
9,99		40448	1,5	MR 3I 321 - 75 × 550 280 S	6 90,1	
9,71		41604	2	MR 3I 360 - 75 × 550 280 S	6 92,7	
11,4		35513	0,95	MR 3I 280 - 60 × 450 225 M	4 123	
11		36575	1,12	MR 3I 320 - 60 × 450 225 M	4 127	
11		36575	1,4	MR 3I 321 - 60 × 450 225 M	4 127	
10,9		37028	1,4	MR 3I 320 - 75 × 550 280 S	6 82,5	
10,9		37028	1,7	MR 3I 321 - 75 × 550 280 S	6 82,5	
10,7		37677	2	MR 3I 360 - 60 × 450 225 M	4 131	
11,1		36421	2,24	MR 3I 360 - 75 × 550 280 S	6 81,1	
14,2		28411	1	MR 3I 250 - 60 × 450 225 M	4 98,5	
14		28957	1,25	MR 3I 280 - 60 × 450 225 M	4 100	
13,4		30212	1,6	MR 3I 320 - 60 × 450 225 M	4 105	
13,4		30212	2	MR 3I 321 - 60 × 450 225 M	4 105	
13,6		29717	2,65	MR 3I 360 - 60 × 450 225 M	4 103	
15,7		25679	1,12	MR 3I 250 - 60 × 450 225 M	4 89	
15,6		25874	1,6	MR 3I 280 - 60 × 450 225 M	4 89,7	
15,5		26002	1,8	MR 3I 320 - 60 × 450 225 M	4 90,1	
15,5		26002	2,24	MR 3I 321 - 60 × 450 225 M	4 90,1	
45		16,9	23853	1,18	MR 3I 250 - 60 × 450 225 M	4 82,7
		16,6	24312	1,5	MR 3I 280 - 60 × 450 225 M	4 84,3
		17	23804	2	MR 3I 320 - 60 × 450 225 M	4 82,5
		17	23804	2,5	MR 3I 321 - 60 × 450 225 M	4 82,5
		18,7	21560	1,32	MR 3I 250 - 60 × 450 225 M	4 74,7
		18,6	21723	1,9	MR 3I 280 - 60 × 450 225 M	4 75,3
		19,7	20487	2,24	MR 3I 320 - 60 × 450 225 M	4 71
		22,7	17796	1,12	MR 3I 225 - 60 × 450 225 M	4 61,7
		22,8	17757	1,5	MR 3I 250 - 60 × 450 225 M	4 61,5
		22,3	18098	2	MR 3I 280 - 60 × 450 225 M	4 62,7
		25,2	16027	1,32	MR 3I 225 - 60 × 450 225 M	4 55,5
		25,2	16049	1,7	MR 3I 250 - 60 × 450 225 M	4 55,6
		25	16171	2,5	MR 3I 280 - 60 × 450 225 M	4 56
		27	14941	1,32	MR 3I 225 - 60 × 450 225 M	4 51,8
		27,1	14908	1,8	MR 3I 250 - 60 × 450 225 M	4 51,7
		26,6	15195	2,36	MR 3I 280 - 60 × 450 225 M	4 52,7
		30,8	13106	1,12	MR 3I 200 - 60 × 450 225 M	4 45,4
	30	13456	1,5	MR 3I 225 - 60 × 450 225 M	4 46,6	
	30	13475	2,12	MR 3I 250 - 60 × 450 225 M	4 46,7	
	29,8	13577	3	MR 3I 280 - 60 × 450 225 M	4 47,1	
	33,7	11988	1,25	MR 3I 200 - 60 × 450 225 M	4 41,5	
	34,7	11657	1,8	MR 3I 225 - 60 × 450 225 M	4 40,4	
	33	12246	2,36	MR 3I 250 - 60 × 450 225 M	4 42,4	
	40,7	9935	1,4	MR 3I 200 - 60 × 450 225 M	4 34,4	
	39,6	10200	2	MR 3I 225 - 60 × 450 225 M	4 35,4	
	37,9	10649	2,65	MR 3I 250 - 60 × 450 225 M	4 36,9	
	44,5	9087	1,6	MR 3I 200 - 60 × 450 225 M	4 31,5	
	45,7	8837	2,36	MR 3I 225 - 60 × 450 225 M	4 30,6	
	41,7	9678	3	MR 3I 250 - 60 × 450 225 M	4 33,5	
	51,4	7855	1,9	MR 3I 200 - 60 × 450 225 M	4 27,2	
	51,3	7882	2,36	MR 3I 225 - 60 × 450 225 M	4 27,3	
	48,8	8284	3,35	MR 3I 250 - 60 × 450 225 M	4 28,7	
	55,2	7472	1,12	MR 2I 180 - 60 × 450 225 M	4 25,4	
	57,8	7142	1,6	MR 2I 200 - 60 × 450 225 M	4 24,2	
	56,1	7357	2,24	MR 2I 225 - 60 × 450 225 M	4 25	
	62,2	6630	0,95	MR 2I 160 - 60 × 450 225 M	4 22,5	
	60	6876	1,32	MR 2I 180 - 60 × 450 225 M	4 23,3	
	63,2	6528	1,9	MR 2I 200 - 60 × 450 225 M	4 22,2	
	60,9	6770	2,65	MR 2I 225 - 60 × 450 225 M	4 23	
	67,7	6090	1,12	MR 2I 160 - 60 × 450 225 M	4 20,7	
67,4	6120	1,5	MR 2I 180 - 60 × 450 225 M	4 20,8		
68,8	5996	2,24	MR 2I 200 - 60 × 450 225 M	4 20,3		
69,8	5907	3,15	MR 2I 225 - 60 × 450 225 M	4 20		
77,4	5327	1,32	MR 2I 160 - 60 × 450 225 M	4 18,1		
77,8	5304	1,5	MR 2I 180 - 60 × 450 225 M	4 18		
79,6	5181	2,65	MR 2I 200 - 60 × 450 225 M	4 17,6		
89,4	4617	1,5	MR 2I 160 - 60 × 450 225 M	4 15,7		
84,3	4896	1,8	MR 2I 180 - 60 × 450 225 M	4 16,6		
87,1	4739	3,15	MR 2I 200 - 60 × 450 225 M	4 16,1		
99,6	4144	1,5	MR 2I 160 - 60 × 450 225 M	4 14,1		
97,2	4243	2	MR 2I 180 - 60 × 450 225 M	4 14,4		
101	4096	3,15	MR 2I 200 - 60 × 450 225 M	4 13,9		
103	4002	1,6	MR 2I 160 - 60 × 450 225 M	4 13,6		
103	4022	2,24	MR 2I 180 - 60 × 450 225 M	4 13,6		
108	3817	3,35	MR 2I 200 - 60 × 450 225 M	4 13		
118	3501	2	MR 2I 160 - 60 × 450 225 M	4 11,9		
118	3486	2,5	MR 2I 180 - 60 × 450 225 M	4 11,8		
136	3034	2,36	MR 2I 160 - 60 × 450 225 M	4 10,3		
131	3147	2,5	MR 2I 180 - 60 × 450 225 M	4 10,7		
151	2723	2,36	MR 2I 160 - 60 × 450 225 M	4 9,24		
174	2367	2,5	MR 2I 160 - 60 × 450 225 M	4 8,03		
218	1890	2,5	MR 2I 160 - 60 × 450 225 M	4 6,41		

1) Powers valid for continuous duty S1; **increase possible** for duty cycles S2 ... S10 (see ch. 1 «General specifications»); in which case M_2 increases and f_s decreases.

2) For complete designation when ordering see ch. 2.

11 - Selection tables (helical gearmotors)

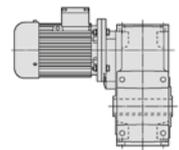

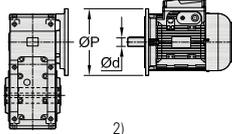
P_1 kW	n_2 min ⁻¹	M_2 N m	f_s		i
1)				2)	
55	11	44703	0,95	MR 3I 320 - 65 × 550 250 M	4 127
	11	44703	1,18	MR 3I 321 - 65 × 550 250 M	4 127
	10,7	46050	1,6	MR 3I 360 - 65 × 550 250 M	4 131
	13,4	36926	1,32	MR 3I 320 - 65 × 550 250 M	4 105
	13,4	36926	1,7	MR 3I 321 - 65 × 550 250 M	4 105
	13,6	36321	2,24	MR 3I 360 - 65 × 550 250 M	4 103
	15,5	31781	1,5	MR 3I 320 - 65 × 550 250 M	4 90,1
	15,5	31781	1,8	MR 3I 321 - 65 × 550 250 M	4 90,1
	15,1	32689	2,5	MR 3I 360 - 65 × 550 250 M	4 92,7
	18,2	27128	1,18	MR 3I 280 - 65 × 550 250 M	4 76,9
	17	29093	1,6	MR 3I 320 - 65 × 550 250 M	4 82,5
	17	29093	2	MR 3I 321 - 65 × 550 250 M	4 82,5
	17,3	28616	2,8	MR 3I 360 - 65 × 550 250 M	4 81,1
	19,7	25039	1,8	MR 3I 320 - 65 × 550 250 M	4 71
	19,7	25039	2,24	MR 3I 321 - 65 × 550 250 M	4 71
	22,8	21703	1,25	MR 3I 250 - 65 × 550 250 M	4 61,5
	22,3	22120	1,6	MR 3I 280 - 65 × 550 250 M	4 62,7
	20,9	23664	2	MR 3I 320 - 65 × 550 250 M	4 67,1
	20,9	23664	2,5	MR 3I 321 - 65 × 550 250 M	4 67,1
	25,2	19588	1,06	MR 3I 225 - 60 × 450 250 M	* 4 55,5
	25,2	19616	1,4	MR 3I 250 - 65 × 550 250 M	4 55,6
	25	19765	2	MR 3I 280 - 65 × 550 250 M	4 56
	24,2	20367	2,24	MR 3I 320 - 65 × 550 250 M	4 57,8
	27	18261	1,06	MR 3I 225 - 60 × 450 250 M	* 4 51,8
	27,1	18221	1,5	MR 3I 250 - 65 × 550 250 M	4 51,7
	26,6	18572	1,9	MR 3I 280 - 65 × 550 250 M	4 52,7
	26,5	18644	2,5	MR 3I 320 - 65 × 550 250 M	4 52,9
	30	16446	1,25	MR 3I 225 - 60 × 450 250 M	* 4 46,6
	30	16469	1,7	MR 3I 250 - 65 × 550 250 M	4 46,7
	29,8	16594	2,36	MR 3I 280 - 65 × 550 250 M	4 47,1
	34,7	14247	1,4	MR 3I 225 - 60 × 450 250 M	* 4 40,4
	33	14967	1,9	MR 3I 250 - 65 × 550 250 M	4 42,4
	34	14520	2,5	MR 3I 280 - 65 × 550 250 M	4 41,2
	39,6	12467	1,6	MR 3I 225 - 60 × 450 250 M	* 4 35,4
	37,9	13016	2,12	MR 3I 250 - 65 × 550 250 M	4 36,9
	37,6	13115	2,65	MR 3I 280 - 65 × 550 250 M	4 37,2
	45,7	10800	1,9	MR 3I 225 - 60 × 450 250 M	* 4 30,6
	41,7	11829	2,5	MR 3I 250 - 65 × 550 250 M	4 33,5
	43	11475	3,15	MR 3I 280 - 65 × 550 250 M	4 32,5
	51,3	9634	1,9	MR 3I 225 - 60 × 450 250 M	* 4 27,3
48,8	10125	2,65	MR 3I 250 - 65 × 550 250 M	4 28,7	
57,8	8729	1,32	MR 2I 200 - 65 × 550 250 M	4 24,2	
56,1	8992	1,8	MR 2I 225 - 65 × 550 250 M	4 25	
56	9002	2,65	MR 2I 250 - 65 × 550 250 M	4 25	
63,2	7979	1,5	MR 2I 200 - 65 × 550 250 M	4 22,2	
60,9	8275	2,12	MR 2I 225 - 65 × 550 250 M	4 23	
63,7	7920	3	MR 2I 250 - 65 × 550 250 M	4 22	
68,8	7329	1,8	MR 2I 200 - 65 × 550 250 M	4 20,3	
69,8	7219	2,5	MR 2I 225 - 65 × 550 250 M	4 20	
79,6	6333	2,24	MR 2I 200 - 65 × 550 250 M	4 17,6	
77,6	6502	2,65	MR 2I 225 - 65 × 550 250 M	4 18,1	
84,3	5984	1,5	MR 2I 180 - 60 × 450 250 M	* 4 16,6	
87,1	5792	2,5	MR 2I 200 - 65 × 550 250 M	4 16,1	
89,5	5632	3	MR 2I 225 - 65 × 550 250 M	4 15,6	
97,2	5186	1,7	MR 2I 180 - 60 × 450 250 M	* 4 14,4	
101	5007	2,5	MR 2I 200 - 65 × 550 250 M	4 13,9	
95,7	5267	3,35	MR 2I 225 - 65 × 550 250 M	4 14,6	
103	4916	1,8	MR 2I 180 - 60 × 450 250 M	* 4 13,6	
108	4665	2,8	MR 2I 200 - 65 × 550 250 M	4 13	
110	4595	3,75	MR 2I 225 - 65 × 550 250 M	4 12,8	
118	4260	2	MR 2I 180 - 60 × 450 250 M	* 4 11,8	
125	4030	3,35	MR 2I 200 - 65 × 550 250 M	4 11,2	
131	3846	2,12	MR 2I 180 - 60 × 450 250 M	* 4 10,7	
137	3687	3,55	MR 2I 200 - 65 × 550 250 M	4 10,2	

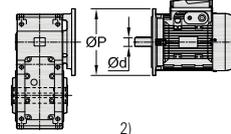
P_1 kW	n_2 min ⁻¹	M_2 N m	f_s		i
1)				2)	
55	150	3353	2,12	MR 2I 180 - 60 × 450 250 M	* 4 9,31
	158	3186	3,75	MR 2I 200 - 65 × 550 250 M	4 8,85
	175	2884	4,25	MR 2I 200 - 65 × 550 250 M	4 8,01
	218	2311	4,75	MR 2I 200 - 65 × 550 250 M	4 6,42
75	10,7	62795	1,18	MR 3I 360 - 75 × 550 280 S	4 131
	13,4	50354	1	MR 3I 320 - 75 × 550 280 S	4 105
	13,4	50354	1,25	MR 3I 321 - 75 × 550 280 S	4 105
	13,6	49529	1,6	MR 3I 360 - 75 × 550 280 S	4 103
	15,5	43337	1,06	MR 3I 320 - 75 × 550 280 S	4 90,1
	15,5	43337	1,32	MR 3I 321 - 75 × 550 280 S	4 90,1
	15,1	44576	1,8	MR 3I 360 - 75 × 550 280 S	4 92,7
	17	39673	1,18	MR 3I 320 - 75 × 550 280 S	4 82,5
	17	39673	1,5	MR 3I 321 - 75 × 550 280 S	4 82,5
	17,3	39022	2	MR 3I 360 - 75 × 550 280 S	4 81,1
	19,7	34145	1,32	MR 3I 320 - 75 × 550 280 S	4 71
	19,7	34145	1,6	MR 3I 321 - 75 × 550 280 S	4 71
	19,2	35120	2,36	MR 3I 360 - 75 × 550 280 S	4 73
	22,8	29595	0,95	MR 3I 250 - 75 × 550 280 S	4 61,5
	22,3	30164	1,18	MR 3I 280 - 75 × 550 280 S	4 62,7
	20,9	32269	1,5	MR 3I 320 - 75 × 550 280 S	4 67,1
	20,9	32269	1,8	MR 3I 321 - 75 × 550 280 S	4 67,1
	21,2	31740	2,5	MR 3I 360 - 75 × 550 280 S	4 66
	25,2	26749	1,06	MR 3I 250 - 75 × 550 280 S	4 55,6
	25	26952	1,5	MR 3I 280 - 75 × 550 280 S	4 56
	24,2	27773	1,6	MR 3I 320 - 75 × 550 280 S	4 57,8
	24,2	27773	2	MR 3I 321 - 75 × 550 280 S	4 57,8
	23,6	28566	2,65	MR 3I 360 - 75 × 550 280 S	4 59,4
	27,1	24847	1,12	MR 3I 250 - 75 × 550 280 S	4 51,7
	26,6	25325	1,4	MR 3I 280 - 75 × 550 280 S	4 52,7
	26,5	25424	1,9	MR 3I 320 - 75 × 550 280 S	4 52,9
	26,5	25424	2,36	MR 3I 321 - 75 × 550 280 S	4 52,9
	26,9	25007	3,15	MR 3I 360 - 75 × 550 280 S	4 52
	30	22458	1,25	MR 3I 250 - 75 × 550 280 S	4 46,7
	29,8	22629	1,8	MR 3I 280 - 75 × 550 280 S	4 47,1
	30,8	21881	2	MR 3I 320 - 75 × 550 280 S	4 45,5
	30,8	21881	2,5	MR 3I 321 - 75 × 550 280 S	4 45,5
	33	20410	1,4	MR 3I 250 - 75 × 550 280 S	4 42,4
	34	19800	1,8	MR 3I 280 - 75 × 550 280 S	4 41,2
	34,4	19589	2,5	MR 3I 320 - 75 × 550 280 S	4 40,7
	37,9	17749	1,6	MR 3I 250 - 75 × 550 280 S	4 36,9
37,6	17884	2	MR 3I 280 - 75 × 550 280 S	4 37,2	
37,5	17974	2,5	MR 3I 320 - 75 × 550 280 S	4 37,4	
41,7	16131	1,8	MR 3I 250 - 75 × 550 280 S	4 33,5	
43	15648	2,24	MR 3I 280 - 75 × 550 280 S	4 32,5	
48,8	13807	2	MR 3I 250 - 75 × 550 280 S	4 28,7	
48,6	13862	2,36	MR 3I 280 - 75 × 550 280 S	4 28,8	
57,8	11904	0,95	MR 2I 200 - 75 × 550 280 S	4 24,2	
56,1	12262	1,32	MR 2I 225 - 75 × 550 280 S	4 25	
56	12276	1,9	MR 2I 250 - 75 × 550 280 S	4 25	
56,9	12090	2,65	MR 2I 280 - 75 × 550 280 S	4 24,6	
63,2	10881	1,12	MR 2I 200 - 75 × 550 280 S	4 22,2	
60,9	11284	1,6	MR 2I 225 - 75 × 550 280 S	4 23	
63,7	10800	2,24	MR 2I 250 - 75 × 550 280 S	4 22	
68,8	9994	1,32	MR 2I 200 - 75 × 550 280 S	4 20,3	
69,8	9844	1,9	MR 2I 225 - 75 × 550 280 S	4 20	
71,1	9672	2,5	MR 2I 250 - 75 × 550 280 S	4 19,7	
79,6	8635	1,6	MR 2I 200 - 75 × 550 280 S	4 17,6	
77,6	8866	2	MR 2I 225 - 75 × 550 280 S	4 18,1	
78,7	8742	2,8	MR 2I 250 - 75 × 550 280 S	4 17,8	
87,1	7899	1,8	MR 2I 200 - 75 × 550 280 S	4 16,1	
89,5	7680	2,12	MR 2I 225 - 75 × 550 280 S	4 15,6	
101	6827	1,9	MR 2I 200 - 75 × 550 280 S	4 13,9	
95,7	7182	2,36	MR 2I 225 - 75 × 550 280 S	4 14,6	

11

1) Powers valid for continuous duty S1; **increase possible** for duty cycles S2 ... S10 (see ch. 1 «General specifications»); in which case M_2 increases and f_s decreases.

2) For complete designation when ordering see ch. 2.

* Mounting position **BSR** (see ch. 1.2).

11 - Selection tables (helical gearmotors)

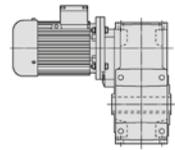

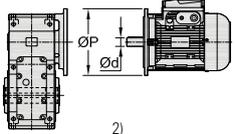
P_1 kW	n_2 min ⁻¹	M_2 N m	f_s		i
1)				2)	
75	108	6361	2	MR 2I 200 - 75 × 550 280 S	4 13
	110	6266	2,65	MR 2I 225 - 75 × 550 280 S	4 12,8
	125	5496	2,5	MR 2I 200 - 75 × 550 280 S	4 11,2
	122	5643	3	MR 2I 225 - 75 × 550 280 S	4 11,5
	137	5027	2,65	MR 2I 200 - 75 × 550 280 S	4 10,2
	141	4888	3,55	MR 2I 225 - 75 × 550 280 S	4 9,95
	158	4345	2,8	MR 2I 200 - 75 × 550 280 S	4 8,85
	175	3933	3,15	MR 2I 200 - 75 × 550 280 S	4 8,01
	218	3151	3,55	MR 2I 200 - 75 × 550 280 S	4 6,42
	90	13,4	60425	1	MR 3I 321 - 75 × 550 280 M
13,6		59434	1,32	MR 3I 360 - 75 × 550 280 M	4 103
15,5		52005	0,9	MR 3I 320 - 75 × 550 280 M	4 90,1
15,5		52005	1,12	MR 3I 321 - 75 × 550 280 M	4 90,1
15,1		53491	1,5	MR 3I 360 - 75 × 550 280 M	4 92,7
17		47607	1	MR 3I 320 - 75 × 550 280 M	4 82,5
17		47607	1,25	MR 3I 321 - 75 × 550 280 M	4 82,5
17,3		46827	1,7	MR 3I 360 - 75 × 550 280 M	4 81,1
19,7		40974	1,12	MR 3I 320 - 75 × 550 280 M	4 71
19,7		40974	1,4	MR 3I 321 - 75 × 550 280 M	4 71
19,2		42144	1,9	MR 3I 360 - 75 × 550 280 M	4 73
22,3		36196	1	MR 3I 280 - 75 × 550 280 M	4 62,7
20,9		38723	1,25	MR 3I 320 - 75 × 550 280 M	4 67,1
20,9		38723	1,5	MR 3I 321 - 75 × 550 280 M	4 67,1
21,2		38088	2	MR 3I 360 - 75 × 550 280 M	4 66
25		32343	1,25	MR 3I 280 - 75 × 550 280 M	4 56
24,2		33327	1,32	MR 3I 320 - 75 × 550 280 M	4 57,8
24,2		33327	1,7	MR 3I 321 - 75 × 550 280 M	4 57,8
23,6		34279	2,24	MR 3I 360 - 75 × 550 280 M	4 59,4
27,1		29816	0,9	MR 3I 250 - 75 × 550 280 M	4 51,7
26,6		30390	1,18	MR 3I 280 - 75 × 550 280 M	4 52,7
26,5		30509	1,5	MR 3I 320 - 75 × 550 280 M	4 52,9
26,5		30509	1,9	MR 3I 321 - 75 × 550 280 M	4 52,9
26,9		30009	2,5	MR 3I 360 - 75 × 550 280 M	4 52
30		26949	1,06	MR 3I 250 - 75 × 550 280 M	4 46,7
29,8		27154	1,5	MR 3I 280 - 75 × 550 280 M	4 47,1
30,8		26258	1,7	MR 3I 320 - 75 × 550 280 M	4 45,5
30,8		26258	2,12	MR 3I 321 - 75 × 550 280 M	4 45,5
29,9		27008	2,65	MR 3I 360 - 75 × 550 280 M	4 46,8
33		24492	1,18	MR 3I 250 - 75 × 550 280 M	4 42,4
34		23760	1,5	MR 3I 280 - 75 × 550 280 M	4 41,2
34,4		23507	2,12	MR 3I 320 - 75 × 550 280 M	4 40,7
34,4		23507	2,65	MR 3I 321 - 75 × 550 280 M	4 40,7
37,9		21299	1,32	MR 3I 250 - 75 × 550 280 M	4 36,9
37,6		21461	1,7	MR 3I 280 - 75 × 550 280 M	4 37,2
37,5		21569	2,12	MR 3I 320 - 75 × 550 280 M	4 37,4
37,5		21569	2,65	MR 3I 321 - 75 × 550 280 M	4 37,4
41,7		19357	1,5	MR 3I 250 - 75 × 550 280 M	4 33,5
43		18778	1,9	MR 3I 280 - 75 × 550 280 M	4 32,5
41,8		19309	2,65	MR 3I 320 - 75 × 550 280 M	4 33,5
48,8		16569	1,7	MR 3I 250 - 75 × 550 280 M	4 28,7
48,6		16634	2	MR 3I 280 - 75 × 550 280 M	4 28,8
46,6		17332	3	MR 3I 320 - 75 × 550 280 M	4 30
56,1		14715	1,12	MR 2I 225 - 75 × 550 280 M	4 25
56		14731	1,6	MR 2I 250 - 75 × 550 280 M	4 25
56,9		14508	2,12	MR 2I 280 - 75 × 550 280 M	4 24,6
56		14731	2,65	MR 2I 320 - 75 × 550 280 M	4 25
63,2		13057	0,95	MR 2I 200 - 75 × 550 280 M	4 22,2
60,9		13540	1,32	MR 2I 225 - 75 × 550 280 M	4 23
63,7		12960	1,8	MR 2I 250 - 75 × 550 280 M	4 22
63,2	13057	2,65	MR 2I 280 - 75 × 550 280 M	4 22,2	
68,8	11993	1,12	MR 2I 200 - 75 × 550 280 M	4 20,3	
69,8	11813	1,6	MR 2I 225 - 75 × 550 280 M	4 20	
71,1	11606	2,12	MR 2I 250 - 75 × 550 280 M	4 19,7	
69,8	11829	2,8	MR 2I 280 - 75 × 550 280 M	4 20,1	

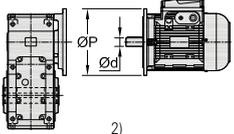
P_1 kW	n_2 min ⁻¹	M_2 N m	f_s		i
1)				2)	
90	79,6	10363	1,32	MR 2I 200 - 75 × 550 280 M	4 17,6
	77,6	10639	1,6	MR 2I 225 - 75 × 550 280 M	4 18,1
	78,7	10490	2,36	MR 2I 250 - 75 × 550 280 M	4 17,8
	87,1	9478	1,5	MR 2I 200 - 75 × 550 280 M	4 16,1
	89,5	9217	1,8	MR 2I 225 - 75 × 550 280 M	4 15,6
	86,5	9534	2,65	MR 2I 250 - 75 × 550 280 M	4 16,2
	101	8193	1,6	MR 2I 200 - 75 × 550 280 M	4 13,9
	95,7	8618	2	MR 2I 225 - 75 × 550 280 M	4 14,6
	95,9	8600	2,65	MR 2I 250 - 75 × 550 280 M	4 14,6
	108	7633	1,7	MR 2I 200 - 75 × 550 280 M	4 13
	110	7519	2,24	MR 2I 225 - 75 × 550 280 M	4 12,8
	107	7701	3,15	MR 2I 250 - 75 × 550 280 M	4 13,1
	125	6595	2,12	MR 2I 200 - 75 × 550 280 M	4 11,2
	122	6771	2,5	MR 2I 225 - 75 × 550 280 M	4 11,5
	119	6961	3,55	MR 2I 250 - 75 × 550 280 M	4 11,8
	137	6033	2,24	MR 2I 200 - 75 × 550 280 M	4 10,2
	141	5866	3	MR 2I 225 - 75 × 550 280 M	4 9,95
	130	6326	4	MR 2I 250 - 75 × 550 280 M	4 10,7
	158	5214	2,36	MR 2I 200 - 75 × 550 280 M	4 8,85
	175	4719	2,65	MR 2I 200 - 75 × 550 280 M	4 8,01
218	3781	3	MR 2I 200 - 75 × 550 280 M	4 6,42	
110	16,7	59021	1,18	MR 3I 360 - 80 × 660 315 S	4 83,7
	20,9	47328	1	MR 3I 320 - 80 × 660 315 S	4 67,1
	20,9	47328	1,25	MR 3I 321 - 80 × 660 315 S	4 67,1
	21,2	46552	1,7	MR 3I 360 - 80 × 660 315 S	4 66
	25	39530	1	MR 3I 280 - 75 × 550 315 S	* 4 56
	24,2	40733	1,12	MR 3I 320 - 80 × 660 315 S	4 57,8
	24,2	40733	1,4	MR 3I 321 - 80 × 660 315 S	4 57,8
	23,6	41897	1,8	MR 3I 360 - 80 × 660 315 S	4 59,4
	26,6	37143	0,95	MR 3I 280 - 75 × 550 315 S	* 4 52,7
	26,5	37289	1,25	MR 3I 320 - 80 × 660 315 S	4 52,9
	26,5	37289	1,6	MR 3I 321 - 80 × 660 315 S	4 52,9
	26,9	36677	2,12	MR 3I 360 - 80 × 660 315 S	4 52
	29,8	33189	1,18	MR 3I 280 - 75 × 550 315 S	* 4 47,1
	30,8	32093	1,4	MR 3I 320 - 80 × 660 315 S	4 45,5
	30,8	32093	1,7	MR 3I 321 - 80 × 660 315 S	4 45,5
	29,9	33010	2,12	MR 3I 360 - 80 × 660 315 S	4 46,8
	34	29040	1,25	MR 3I 280 - 75 × 550 315 S	* 4 41,2
	34,4	28731	1,7	MR 3I 320 - 80 × 660 315 S	4 40,7
	34,4	28731	2,12	MR 3I 321 - 80 × 660 315 S	4 40,7
	33,1	29800	2,36	MR 3I 360 - 80 × 660 315 S	4 42,3
	37,6	26230	1,32	MR 3I 280 - 75 × 550 315 S	* 4 37,2
	37,5	26362	1,7	MR 3I 320 - 80 × 660 315 S	4 37,4
	37,5	26362	2,12	MR 3I 321 - 80 × 660 315 S	4 37,4
	36,4	27115	2,65	MR 3I 360 - 80 × 660 315 S	4 38,4
	43	22951	1,5	MR 3I 280 - 75 × 550 315 S	* 4 32,5
	41,8	23600	2,12	MR 3I 320 - 80 × 660 315 S	4 33,5
	41,8	23600	2,36	MR 3I 321 - 80 × 660 315 S	4 33,5
	40,3	24479	3	MR 3I 360 - 80 × 660 315 S	4 34,7
	48,6	20330	1,6	MR 3I 280 - 75 × 550 315 S	* 4 28,8
	46,6	21184	2,36	MR 3I 320 - 80 × 660 315 S	4 30
56	18004	1,32	MR 2I 250 - 80 × 660 315 S	4 25	
56,9	17732	1,8	MR 2I 280 - 80 × 660 315 S	4 24,6	
56	18004	2,12	MR 2I 320 - 80 × 660 315 S	4 25	
63,7	15840	1,5	MR 2I 250 - 80 × 660 315 S	4 22	
63,2	15958	2,12	MR 2I 280 - 80 × 660 315 S	4 22,2	
61,3	16457	2,5	MR 2I 320 - 80 × 660 315 S	4 22,8	
71,1	14185	1,7	MR 2I 250 - 80 × 660 315 S	4 19,7	
69,8	14458	2,36	MR 2I 280 - 80 × 660 315 S	4 20,1	
78,7	12821	2	MR 2I 250 - 80 × 660 315 S	4 17,8	
78,1	12919	2,65	MR 2I 280 - 80 × 660 315 S	4 17,9	
86,5	11652	2,12	MR 2I 250 - 80 × 660 315 S	4 16,2	
89,2	11304	2,8	MR 2I 280 - 80 × 660 315 S	4 15,7	

1) Powers valid for continuous duty S1; **increase possible** for duty cycles S2 ... S10 (see ch. 1 «General specifications»); in which case M_2 increases and f_s decreases.

2) For complete designation when ordering see ch. 2.

* Mounting position **B5R** (see ch. 1.2).

11 - Selection tables (helical gearmotors)

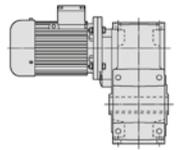

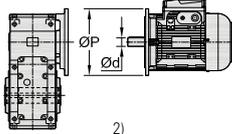
P_1 kW	n_2 min ⁻¹	M_2 N m	f_s		i
1)				2)	
110	95,7	10533	1,7	MR 2I 225 - 75 × 550 315 S	* 4 14,6
	95,9	10511	2,12	MR 2I 250 - 80 × 660 315 S	4 14,6
	95,2	10589	3	MR 2I 280 - 80 × 660 315 S	4 14,7
	110	9190	1,8	MR 2I 225 - 75 × 550 315 S	* 4 12,8
	107	9412	2,5	MR 2I 250 - 80 × 660 315 S	4 13,1
	105	9593	3,35	MR 2I 280 - 80 × 660 315 S	4 13,3
	122	8276	2,12	MR 2I 225 - 75 × 550 315 S	* 4 11,5
	119	8507	2,8	MR 2I 250 - 80 × 660 315 S	4 11,8
	141	7170	2,36	MR 2I 225 - 75 × 550 315 S	* 4 9,95
	130	7732	3,15	MR 2I 250 - 80 × 660 315 S	4 10,7
	158	6395	2,5	MR 2I 225 - 75 × 550 315 S	* 4 8,88
	132	16,7	70826	1	MR 3I 360 - 80 × 660 315 M
20,9		56794	1,06	MR 3I 321 - 80 × 660 315 M	4 67,1
21,2		55863	1,4	MR 3I 360 - 80 × 660 315 M	4 66
24,2		48880	0,9	MR 3I 320 - 80 × 660 315 M	4 57,8
24,2		48880	1,12	MR 3I 321 - 80 × 660 315 M	4 57,8
23,6		50276	1,5	MR 3I 360 - 80 × 660 315 M	4 59,4
26,5		44746	1,06	MR 3I 320 - 80 × 660 315 M	4 52,9
26,5		44746	1,32	MR 3I 321 - 80 × 660 315 M	4 52,9
26,9		44013	1,7	MR 3I 360 - 80 × 660 315 M	4 52
30,8		38511	1,18	MR 3I 320 - 80 × 660 315 M	4 45,5
30,8		38511	1,5	MR 3I 321 - 80 × 660 315 M	4 45,5
29,9		39612	1,8	MR 3I 360 - 80 × 660 315 M	4 46,8
34,4		34477	1,4	MR 3I 320 - 80 × 660 315 M	4 40,7
34,4		34477	1,8	MR 3I 321 - 80 × 660 315 M	4 40,7
33,1		35761	2	MR 3I 360 - 80 × 660 315 M	4 42,3
37,5		31634	1,4	MR 3I 320 - 80 × 660 315 M	4 37,4
37,5		31634	1,8	MR 3I 321 - 80 × 660 315 M	4 37,4
36,4		32538	2,24	MR 3I 360 - 80 × 660 315 M	4 38,4
41,8		28320	1,8	MR 3I 320 - 80 × 660 315 M	4 33,5
41,8		28320	2	MR 3I 321 - 80 × 660 315 M	4 33,5
40,3		29375	2,36	MR 3I 360 - 80 × 660 315 M	4 34,7
46,6		25420	2	MR 3I 320 - 80 × 660 315 M	4 30
46,6		25420	2,24	MR 3I 321 - 80 × 660 315 M	4 30
46,3		25609	2,65	MR 3I 360 - 80 × 660 315 M	4 30,3
56		21605	1,06	MR 2I 250 - 80 × 660 315 M	4 25
56,9		21278	1,5	MR 2I 280 - 80 × 660 315 M	4 24,6
56		21605	1,8	MR 2I 320 - 80 × 660 315 M	4 25
56		21605	2,24	MR 2I 321 - 80 × 660 315 M	4 25
54,4		22256	3,15	MR 2I 360 - 80 × 660 315 M	4 25,7
63,7		19008	1,25	MR 2I 250 - 80 × 660 315 M	4 22
63,2		19150	1,8	MR 2I 280 - 80 × 660 315 M	4 22,2
61,3		19748	2	MR 2I 320 - 80 × 660 315 M	4 22,8
61,3		19748	2,5	MR 2I 321 - 80 × 660 315 M	4 22,8
71,1		17022	1,4	MR 2I 250 - 80 × 660 315 M	4 19,7
69,8		17350	1,9	MR 2I 280 - 80 × 660 315 M	4 20,1
67,8		17847	2,5	MR 2I 320 - 80 × 660 315 M	4 20,6
78,7		15386	1,6	MR 2I 250 - 80 × 660 315 M	4 17,8
78,1		15502	2,24	MR 2I 280 - 80 × 660 315 M	4 17,9
78,8		15360	2,8	MR 2I 320 - 80 × 660 315 M	4 17,8
86,5		13983	1,8	MR 2I 250 - 80 × 660 315 M	4 16,2
89,2		13565	2,36	MR 2I 280 - 80 × 660 315 M	4 15,7
88		13751	3,55	MR 2I 320 - 80 × 660 315 M	4 15,9
95,9		12613	1,8	MR 2I 250 - 80 × 660 315 M	4 14,6
95,2		12707	2,5	MR 2I 280 - 80 × 660 315 M	4 14,7
107		11295	2,12	MR 2I 250 - 80 × 660 315 M	4 13,1
105		11512	2,8	MR 2I 280 - 80 × 660 315 M	4 13,3
119		10209	2,36	MR 2I 250 - 80 × 660 315 M	4 11,8
118		10286	3,35	MR 2I 280 - 80 × 660 315 M	4 11,9
130	9278	2,65	MR 2I 250 - 80 × 660 315 M	4 10,7	
134	9001	3,75	MR 2I 280 - 80 × 660 315 M	4 10,4	
152	7942	3,15	MR 2I 250 - 80 × 660 315 M	4 9,19	

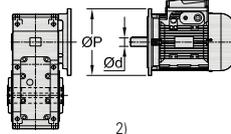
P_1 kW	n_2 min ⁻¹	M_2 N m	f_s		i
1)				2)	
160	21,2	67712	1,12	MR 3I 360 - 80 × 660 315 MC	4 66
	24,2	59248	0,95	MR 3I 321 - 80 × 660 315 MC	4 57,8
	23,6	60941	1,25	MR 3I 360 - 80 × 660 315 MC	4 59,4
	26,5	54238	1,06	MR 3I 321 - 80 × 660 315 MC	4 52,9
	26,9	53349	1,4	MR 3I 360 - 80 × 660 315 MC	4 52
	30,8	46680	0,95	MR 3I 320 - 80 × 660 315 MC	4 45,5
	30,8	46680	1,18	MR 3I 321 - 80 × 660 315 MC	4 45,5
	29,9	48014	1,5	MR 3I 360 - 80 × 660 315 MC	4 46,8
	34,4	41790	1,18	MR 3I 320 - 80 × 660 315 MC	4 40,7
	34,4	41790	1,5	MR 3I 321 - 80 × 660 315 MC	4 40,7
	33,1	43346	1,6	MR 3I 360 - 80 × 660 315 MC	4 42,3
	37,5	38345	1,18	MR 3I 320 - 80 × 660 315 MC	4 37,4
	37,5	38345	1,5	MR 3I 321 - 80 × 660 315 MC	4 37,4
	36,4	39440	1,8	MR 3I 360 - 80 × 660 315 MC	4 38,4
	41,8	34328	1,4	MR 3I 320 - 80 × 660 315 MC	4 33,5
	41,8	34328	1,7	MR 3I 321 - 80 × 660 315 MC	4 33,5
	40,3	35606	2	MR 3I 360 - 80 × 660 315 MC	4 34,7
	46,6	30813	1,7	MR 3I 320 - 80 × 660 315 MC	4 30
	46,6	30813	1,8	MR 3I 321 - 80 × 660 315 MC	4 30
	46,3	31041	2,24	MR 3I 360 - 80 × 660 315 MC	4 30,3
	56,9	25791	1,18	MR 2I 280 - 80 × 660 315 MC	4 24,6
	56	26188	1,5	MR 2I 320 - 80 × 660 315 MC	4 25
	56	26188	1,8	MR 2I 321 - 80 × 660 315 MC	4 25
	54,4	26977	2,5	MR 2I 360 - 80 × 660 315 MC	4 25,7
	63,2	23212	1,5	MR 2I 280 - 80 × 660 315 MC	4 22,2
	61,3	23938	1,7	MR 2I 320 - 80 × 660 315 MC	4 22,8
	61,3	23938	2,12	MR 2I 321 - 80 × 660 315 MC	4 22,8
	59,9	24469	3	MR 2I 360 - 80 × 660 315 MC	4 23,4
	69,8	21030	1,6	MR 2I 280 - 80 × 660 315 MC	4 20,1
	67,8	21632	2,12	MR 2I 320 - 80 × 660 315 MC	4 20,6
	67,8	21632	2,65	MR 2I 321 - 80 × 660 315 MC	4 20,6
	78,1	18791	1,8	MR 2I 280 - 80 × 660 315 MC	4 17,9
	78,8	18618	2,36	MR 2I 320 - 80 × 660 315 MC	4 17,8
	89,2	16442	2	MR 2I 280 - 80 × 660 315 MC	4 15,7
	88	16668	3	MR 2I 320 - 80 × 660 315 MC	4 15,9
	95,2	15402	2	MR 2I 280 - 80 × 660 315 MC	4 14,7
	105	13954	2,36	MR 2I 280 - 80 × 660 315 MC	4 13,3
	118	12468	2,65	MR 2I 280 - 80 × 660 315 MC	4 11,9
	134	10910	3,15	MR 2I 280 - 80 × 660 315 MC	4 10,4
	152	9664	3,35	MR 2I 280 - 80 × 660 315 MC	4 9,22

1) Powers valid for continuous duty S1; **increase possible** for duty cycles S2 ... S10 (see ch. 1 «General specifications»); in which case M_2 increases and f_s decreases.
 2) For complete designation when ordering see ch. 2.
 * Mounting position **B5R** (see ch. 1.2).

This page is intentionally left blank.

12 – Dimensions, designs, mounting positions (helical gearmotors)

12.1 - Gearmotors MR 2I	228
Dimensions.....	228
Designs (direction of rotation).....	230
Mounting positions.....	231
Lubrication details.....	232
12.2 - Gearmotors MR 3I	234
Dimensions.....	234
Designs (direction of rotation).....	236
Mounting positions.....	237
Lubrication details.....	238
12.3 - Gearmotors MR 4I	240
Dimensions.....	240
Designs (direction of rotation).....	241
Mounting positions.....	242
Lubrication details.....	243
12.4 - Gearmotors MR 2I – Long model	244
Dimensions.....	244
Designs (direction of rotation).....	246
Mounting positions.....	247
Lubrication details.....	248
12.5 - Gearmotors MR 3I – Long model	250
Dimensions.....	250
Designs (direction of rotation).....	252
Mounting positions.....	253
Lubrication details.....	254

12 - Dimensions, designs, mounting positions (helical gearmotors)

12.1 - Gearmotors MR 21

Dimensions

MR 21 40 ... 125

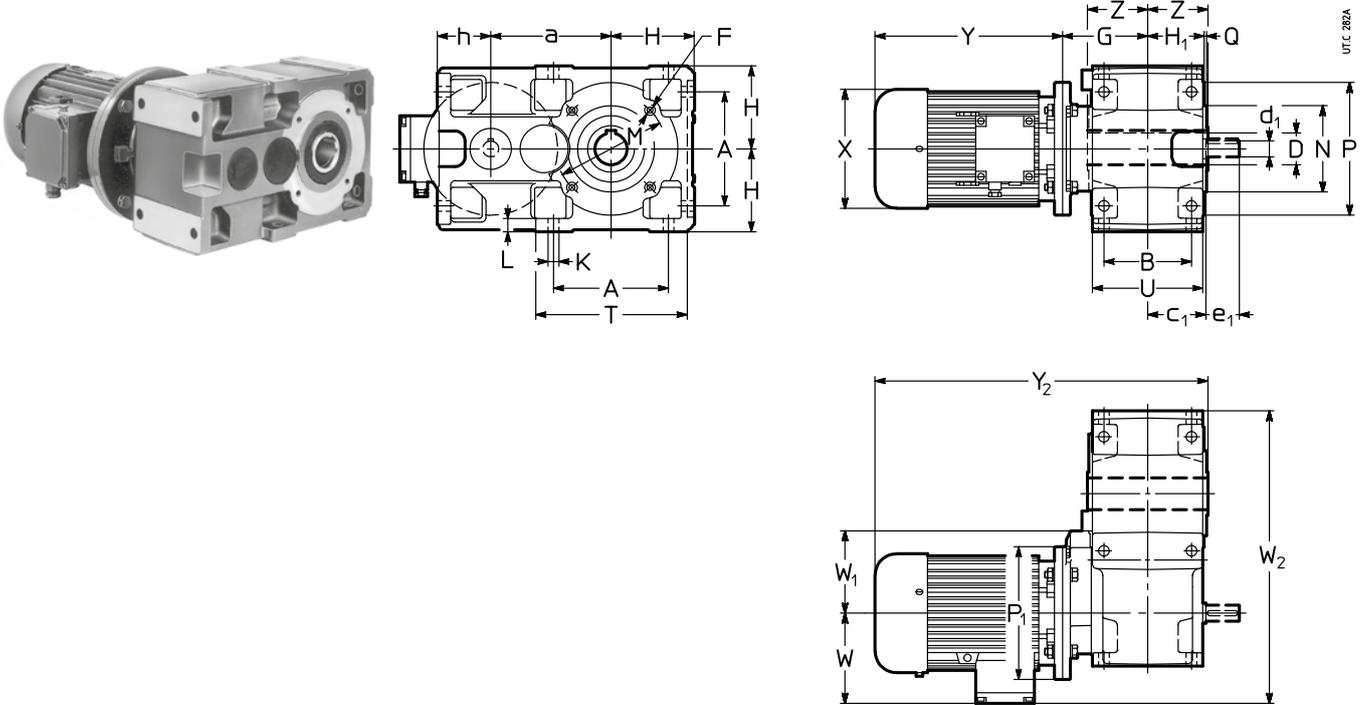

Size	Gear red.	Motor	a	A	B	c ₁	D Ø H7	d ₁ Ø	e ₁	F	G	H h11	H ₁ h11	h	K Ø	L	M Ø	N Ø h6	P Ø	Q	T	U	Z	P ₁ Ø	X Ø	Y ≈	Y ₂ ≈	W ≈	W ₁	W ₂ ≈	kg															
																																1)	2)	2)	2)											
40	63	71 ⁶⁾	73,5	73	65	43	19	11	23	M5	69,5	56	41,5	40,5	7	10	75	60	90	2,5	102	80	46	140	123	189	244	305	360	95	56	225	12	14												
																																			1)	2)	2)	2)								
50	63	71	90	86	75	51	24	14	30	M6	77	67	49	50	9,5	12	85	70	105	2,5	120	95	53	140	123	189	244	319	374	95	70	252	16	18												
																																			1)	2)	2)	2)								
																																			80 ⁶⁾	115	79	254	323	410	112	80	269	22	278	22
63	71	80	113	102	90	61	30	16	30	M8	90	80	58,5	62	11,5	14	100	80	120	3	143	114	63	160	138	216	278	369	431	112	80	307	23	26												
																																			1)	2)	2)	2)								
																																			64	115	32	386	455	410	112	100	316	28	32	
																																			90	115	32	366	440	519	141	100	336	34	40	
80	90	100 ⁵⁾	142,5	132	106	72	38	19	40	M10	108	100	69,5	70	14	17	130	110	160	3,5	180	135	75	200	176	287	366	470	549	141	100	384	46	52												
																																			1)	2)	2)	2)								
																																			81	112 ⁴⁾	40	493	588	151	125	394	50	57		
100	90	100	180	172	131	87	48	24	50	M12	130	125	84,5	80	16	20	165	130	200	3,5	228	165	90	200	176	287	366	507	586	141	125	446	67	73												
																																			1)	2)	2)	2)								
																																			100	250	194	310	405	493	588	151	125	394	50	57
																																			112	250	218	336	435	556	655	163	125	468	84	93
125	112	132	225	212	162	107	60	28	60	3)	159	150	103,5	100	18	23	215	180	250	4	274	201	110	250	218	336	435	605	704	163	166	538	118	127												
																																			1)	2)	2)	2)								
																																			132	300	257	445	553	719	827	194	166	569	153	165
																																			160	350	315	539	640	828	929	241	175	616	199	204
180	350	354	613	734	902	1023	278	175	653	258	248																																			

1) Working length of thread 2 · F.

2) Values valid for brake motor.

3) For dimension, number and angular position see ch. 6.

4) On request for 100LB 4, 112M 4 and 132M 4 also mounting position **B5R** (see ch. 1.2; dimensions Y and Y₂ increase by 27 mm, 26 mm and 35 mm, respectively).

5) Mounting position **B5R** (see ch. 1.2).

6) Mounting position **B5A** (see ch. 1.2).



12 - Dimensions, designs, mounting positions (helical gearmotors)

MR 2I 140 ... 360

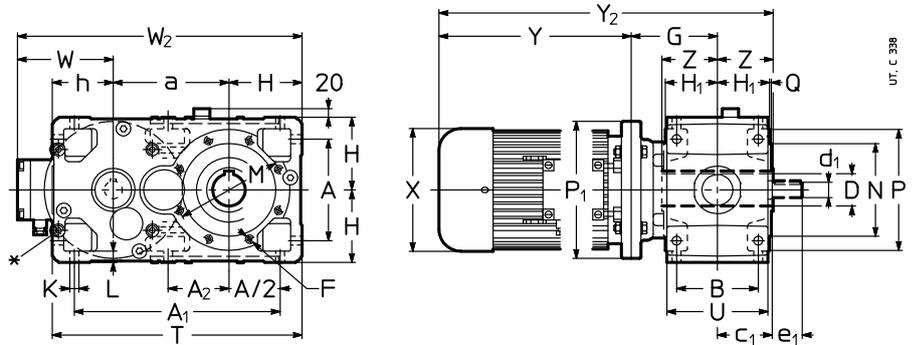
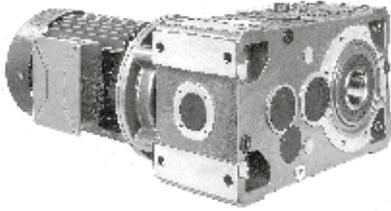

Size	Gear red.	Motor B5	a	A	A ₁	A ₂	B	c ₁	D ∅ H7	d ₁ ∅	e ₁	F	G	H h11	H ₁ h11	h	K ∅	L	M ∅	N ∅ h6	P ∅	T	Z	P ₁ ∅	X ∅	Y	Y ₂	W	W ₂	kg			
			1)	h11	h11	∅	∅	1)	h11	∅	∅	∅	∅	∅	∅	∅	∅	∅	∅	∅	∅	∅	∅	∅	∅	∅	∅	∅	∅	∅	∅	∅	
140	132 160 180 200	240	212	427	127	162	107	70	28	60	4)	159 179	150	103,5	125	18	23	265	230	300	515	201	125	300	257	445	553	729	837	194	584	185	197
																				230	300	201	125	350	315	539	640	843	944	241	631	231	236
																				230	300	201	125	350	354	613	734	917	1038	278	668	290	280
																				230	300	201	125	350	354	654	734	958	1038	278	668	316	304
160	160 180 200 225	285	252	507	-	201	132	80	38	80	M16	204	180	128,5	150	22	28	265	230	300	615	249	136	350	315	539	640	879	980	241	706	299	304
													194	180	128,5	150	22	28	265	230	300	249	136	350	354	613	734	953	1074	278	743	358	348
													224	180	128,5	150	22	28	300	230	300	249	136	350	354	654	734	984	1064	278	743	384	372
																			250	300	300	249	136	350	354	710	-	1070	-	298	763	475	-
180	180 200 225 250	305	252	527	170	201	132	90	38	80	M16	204	180	128,5	150	22	28	300	250	350	635	249	150	350	354	613	734	967	1088	278	763	376	366
													194	180	128,5	150	22	28	300	250	350	249	150	350	354	654	734	998	1078	278	763	402	390
													224	180	128,5	150	22	28	300	250	350	249	150	350	354	710	-	1084	-	298	783	493	-
																			250	350	350	249	150	350	354	735	-	1109	-	298	783	516	-
200	200 225 250 280	360	320	635	-	250	162	100	48	110	4)	225	225	158	180	27	34	350	300	400	765	307	167	400	354	654	734	1046	1126	278	863	517	505
													255	225	158	180	27	34	350	300	400	307	167	400	354	710	-	1132	-	298	883	608	-
													255	225	158	180	27	34	350	300	400	307	167	400	354	735	-	1157	-	298	883	631	-
																			350	400	400	307	167	400	354	819	-	1241	-	360	945	817	-
225	225 250 280 315 ³⁾	385	320	660	223	250	162	110	48	110	M20	255	225	158	180	27	34	400	350	450	790	307	180	450	411	710	-	1145	-	298	908	639	-
													255	225	158	180	27	34	400	350	450	307	180	450	411	735	-	1170	-	298	883	662	-
													255	225	158	180	27	34	400	350	450	307	180	450	411	819	-	1254	-	360	970	848	-
																			400	350	450	307	180	450	411	820	-	1255	-	360	970	809	-
250	250 280 315	450	396	791	-	310	200	125	55	110	4)	290	280	195	225	33	42	500	450	550	955	380	206	550	411	735	-	1231	-	298	1028	865	-
													310	280	195	225	33	42	500	450	550	380	206	550	411	819	-	1315	-	360	1090	1051	-
													310	280	195	225	33	42	500	450	550	380	206	550	411	962	-	1478	-	445	1175	1300	-
																			500	450	550	380	206	550	411	962	-	1478	-	445	1175	1300	-
280	280 315	480	396	821	277	310	200	140	55	110	M24	290	280	195	225	33	42	500	450	550	985	380	222	550	411	819	-	1331	-	360	1120	1105	-
													310	280	195	225	33	42	500	450	550	380	222	550	411	962	-	1494	-	445	1205	1354	-
													310	280	195	225	33	42	500	450	550	380	222	550	411	962	-	1494	-	445	1205	1354	-
																			500	450	550	380	222	550	411	962	-	1494	-	445	1205	1354	-
320	280 315	570	510	1005	-	386	245	160	70	140	4)	336	355	241	280	39	52	600	550	660	1205	470	254	550	411	819	-	1409	-	360	1285	1463	-
													336	355	241	280	39	52	600	550	660	470	254	550	411	962	-	1570	-	445	1370	1711	-
													336	355	241	280	39	52	600	550	660	470	254	550	411	962	-	1570	-	445	1370	1711	-
																			600	550	660	470	254	550	411	962	-	1570	-	445	1370	1711	-
360	315	610	510	1045	358	386	245	180	70	140	M30	356	355	241	280	39	52	600	550	660	1245	470	273	660	604	962	-	1591	-	445	1410	1806	-
													356	355	241	280	39	52	600	550	660	470	273	660	604	962	-	1591	-	445	1410	1806	-
													356	355	241	280	39	52	600	550	660	470	273	660	604	962	-	1591	-	445	1410	1806	-
																			600	550	660	470	273	660	604	962	-	1591	-	445	1410	1806	-

* Machined surface and N.4 threaded holes (dimensions in ch. 6 «Gear reducer input face»).

1) Working length of thread 2 · F.

2) Values valid for brake motor.

3) Mounting position **B5R** (see ch. 1.2).

4) For dimension, number and angular position see ch. 6.



12 - Dimensions, designs, mounting positions (helical gearmotors)

Designs¹⁾ (direction of rotation)

MR 2I 40 ... 125

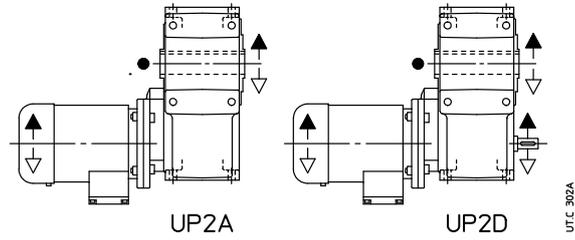

MR 2I 140 ... 360

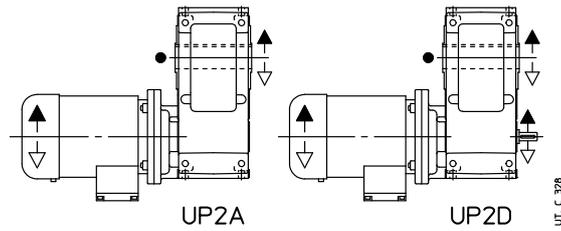

● Position of reference groove (see ch. 6) for radial load verification.

1) For motor design see ch. 2.

12 - Dimensions, designs, mounting positions (helical gearmotors)

Mounting positions

Unless otherwise stated, gear reducers are supplied in mounting position **B3** (see ch. 2).

MR 2I 40 ... 125

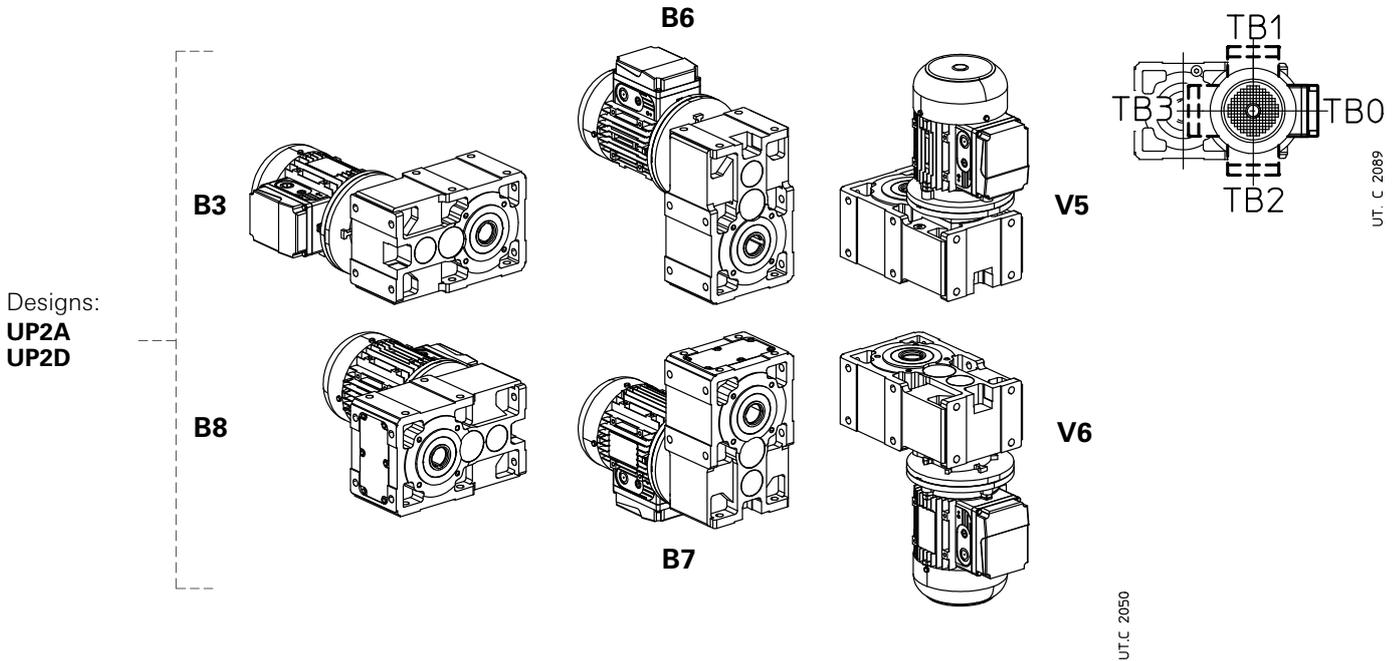

MR 2I 140 ... 360

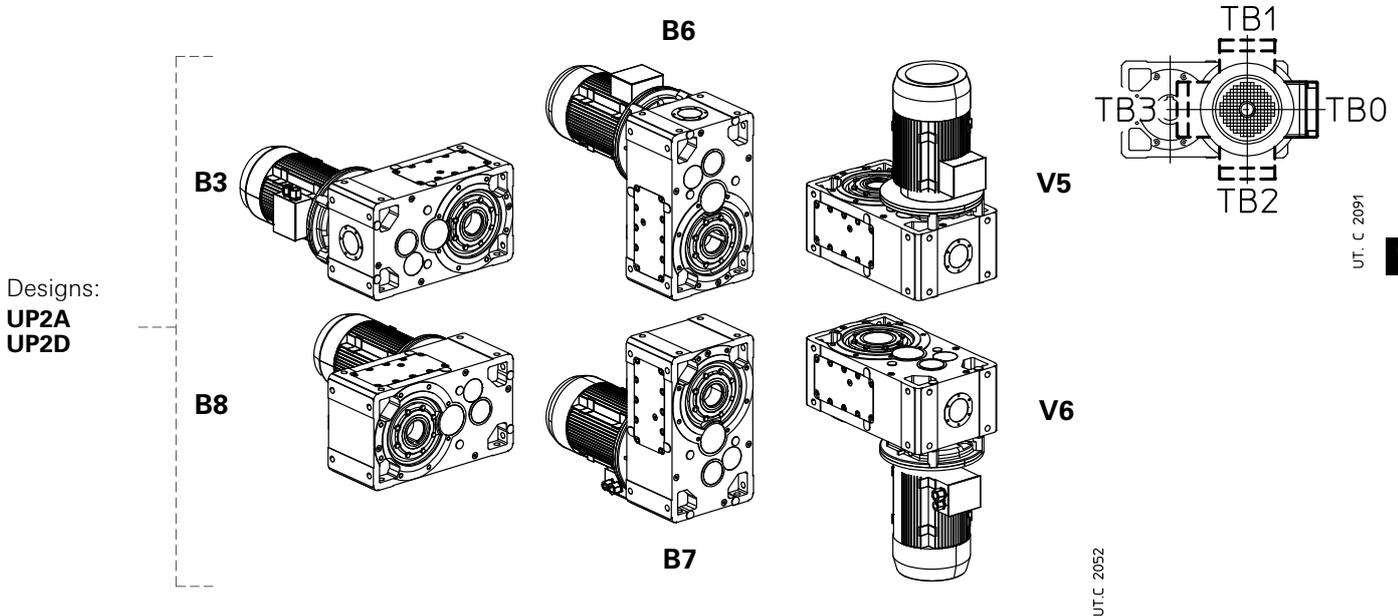

Oil quantity MR 2I 40 ... 360

Stated oil quantities [l] are approximate for provisioning. The exact oil quantity the gear reducer is to be filled with is defined by the level plug.

Mounting position	40	50	63, 64	80, 81	100	125	140	160	180	200	225	250	280	320, 321	360
B3	0,4	0,6	0,9	1,5	2,9	5,6	6,6	12	13	25	26	47	51	97	100
B8	0,4	0,6	0,9	1,5	2,9	5,6	6,6	12	13	25	26	47	51	97	100
B6	0,55	0,8	1,2	2,3	5	9	9,7	18	19	35	37	67	72	137	140
B7	0,55	0,8	1,2	2,3	5	9	9,7	18	19	35	37	67	72	137	140
V5	0,55	0,8	1,2	2,3	5	9	9,7	18	19	35	37	67	72	137	140
V6	0,55	0,8	1,2	2,3	5	9	9,7	18	19	35	37	67	72	137	140

12 - Dimensions, designs, mounting positions (helical gearmotors)

Lubrication details

MR 2I 100, 125

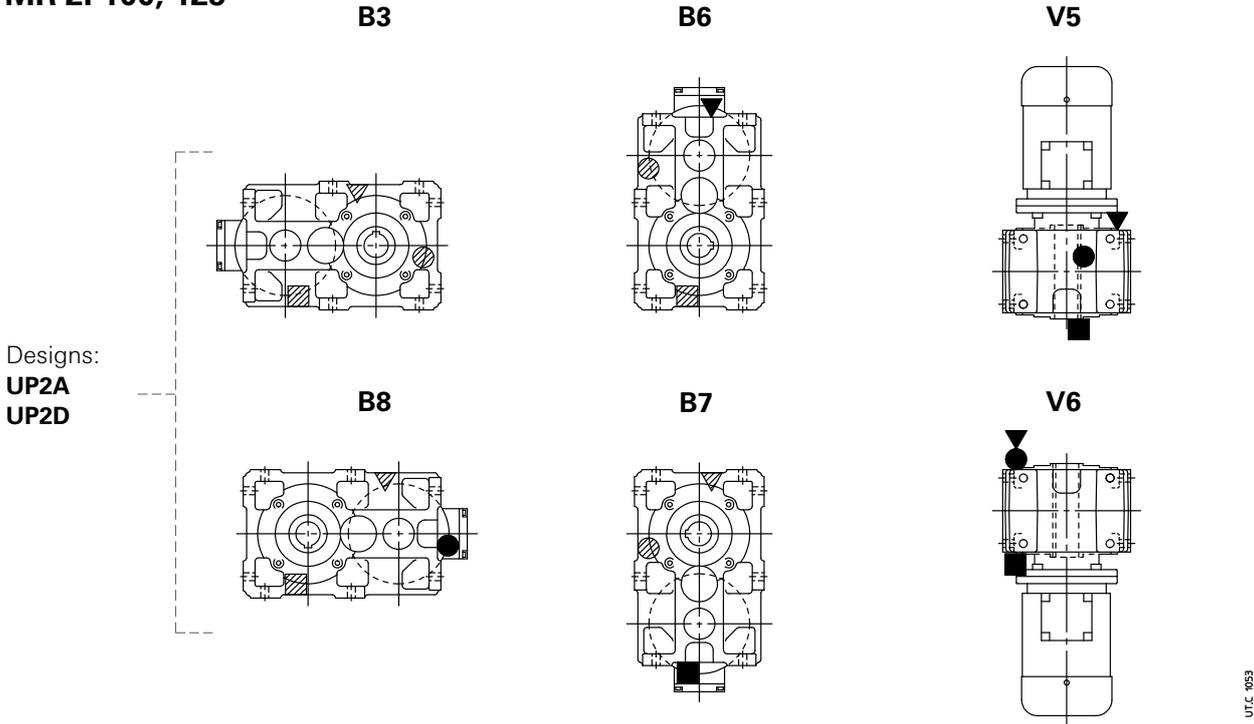

MR 2I 140 ... 360

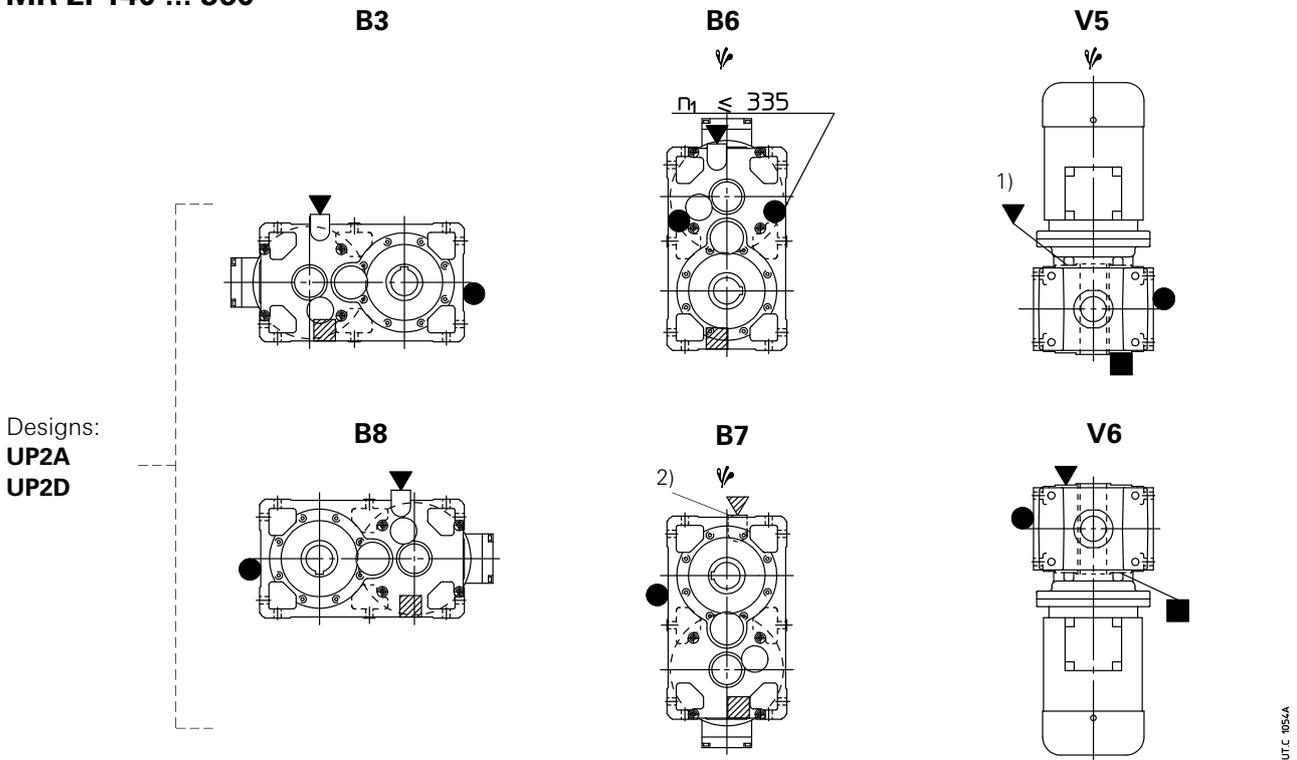

1) Oil filler plug possible even on low speed shaft side.

2) Oil filler plug possible even on opposite side.

▽ Possible high oil splash: for the corrective factor ft_3 of nominal thermal power P_{tN} see ch. 4.

- ▼ oil filler plug
- oil level plug
- oil drain plug
- ▼ oil filler plug with oil level dip stick
- ▽ oil filler plug on opposite side (not in view)
- oil level plug on opposite side (not in view)
- oil drain plug on opposite side (not in view)

This page is intentionally left blank.

12 - Dimensions, designs, mounting positions (helical gearmotors)

12.2 - Gearmotors MR 31

Dimensions

MR 31 40 ... 125

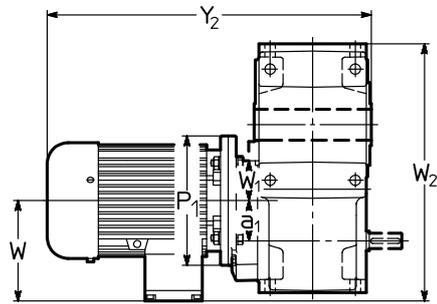
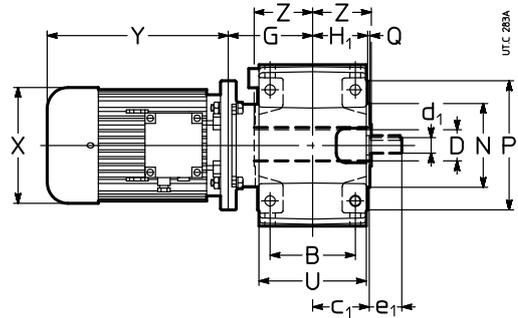
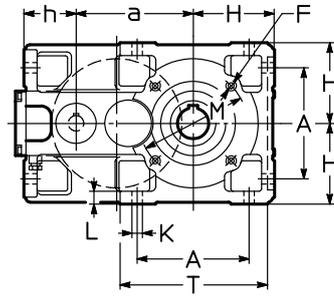
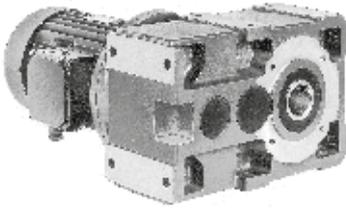

Gear red.	Motor B5	Size		a ₁	A	B	c ₁	D Ø H7	d ₁ Ø	e ₁	F 1)	G	H h11	H ₁	h h11	K Ø	L	M Ø	N Ø h6	P Ø	Q	T	U	Z	P ₁ Ø	X Ø	Y ≈	Y ₂ ≈	W ≈	W ₁	W ₂ ≈	kg			
		40	63																																
		40	63	73,5 30	73	65	43	19	11	23	M5	69,5	56	41,5	40,5	7	10	75	60	90	2,5	102	80	46	140	123	189	244	305	360	95	26	194,5	14	16
		50	63 71	90 32	86	75	51	24	14	30	M6	77 79	67	49	50	9,5	12	85	70	105	2,5	120	95	53	140 160	123 138	189 216	244 278	319 348	374 410	95 112	35 35	220 237	19 22	21 25
		63 64	63 71 80 90 ⁴⁾	113 (63) 115 (64) 40	102	90	61	30 (63) 32 (64)	16	30	M8	90	80	58,5	62	11,5	14	100	80	120	3	143	114	63	140 160 200 200	123 138 156 176	189 216 233 287	244 278 302 387	342 369 455 540	397 431 121 141	95 112 40 40	40 276 296	24 32 38	26 36 44	
		80 81	71 80 90 100 ⁴⁾	142,5 50	132	106	72	38 (80) 40 (81)	19	40	M10	108	100	69,5	70	14	17	130	110	160	3,5	180	135	75	160 200 200 200	138 156 176 194	216 233 287 337	278 302 366 432	399 416 470 520	461 485 141 151	112 121 50 50	50 312,5 333,5 343,5	35 40 46 52	38 44 52 59	
		100	80 90 100 112	180 62,5	172	131	87	48	24	50	M12	130	125	84,5	80	16	20	165	130	200	3,5	228	165	90	200 200 250 250	156 176 194 218	233 287 310 336	302 366 405 435	453 507 530 556	522 586 625 655	121 141 151 163	62 62 62 62	385 385 393,5 405,5	62 68 72 85	66 74 79 94
		125	90 100 112 132	225 80	212	162	107	60	28	60	3)	159	150	103,5	100	18	23	215	180	250	4	274	201	110	200 250 250 300	176 194 218 257	287 310 336 445	366 405 435 553	556 579 605 719	635 674 704 827	141 151 163 194	86 86 86 86	475 475 475 489	109 113 126 161	115 120 135 173

1) Working length of thread 2 · F.
 2) Values valid for brake motor.
 3) For dimension, number and angular position see ch. 6.
 4) Mounting position **B5R** (see ch. 1.2).



12 - Dimensions, designs, mounting positions (helical gearmotors)

MR 3I 140 ... 360

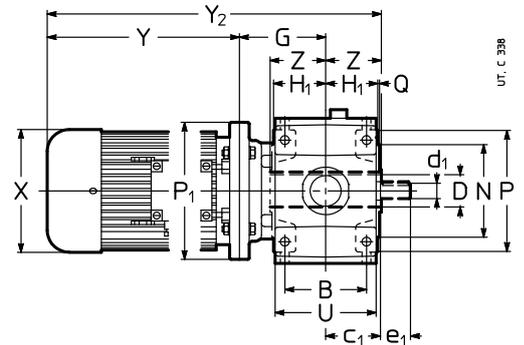
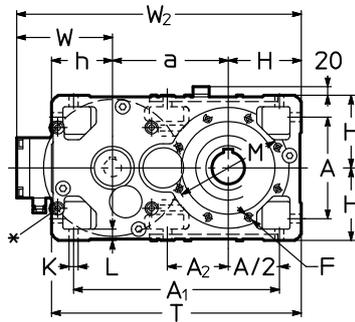
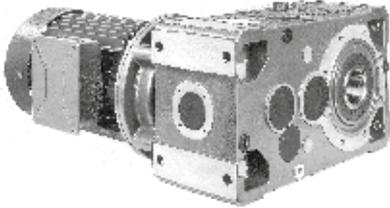

Size	Gear red.	Motor	a	A	A ₁	A ₂	B	c ₁	D ∅ H7	d ₁ ∅	e ₁	F	G	H h11	H ₁	h h11	K ∅	L	M ∅	N ∅ h6	P ∅	T	Z	P ₁ ∅	X ∅	Y	Y ₂	W	W ₂	kg			
			1)	2)	2)	2)	2)	2)	2)	2)	2)	2)	2)	2)	2)	2)	2)	2)	2)	2)	2)	2)	2)	2)	2)	2)	2)	2)	2)	2)	2)	2)	
140	B5	100	240	212	427	127	162	107	70	24	50	4)	134	150	103,5	125	18	23	265	230	300	515	125	250	194	310	405	569	664	151	541	137	144
		112																			230	300	201	250	218	336	435	595	694	163	553	145	156
		132												159							4			300	257	445	553	729	837	194	584	185	197
		160 ³⁾												179							Q	U		300	315	539	640	843	944	241	631	231	236
160	B5	100	285	252	507	-	201	132	80	28	60	M16	179	180	128,5	150	22	28	265	230	300	615	136	250	194	310	405	625	720	151	616	205	212
		112																		4			250	218	336	435	651	750	163	628	213	224	
		132												204									300	257	445	553	760	868	194	659	253	265	
		160																			5			350	315	539	640	879	980	241	706	299	304
180	B5	112	305	252	527	170	201	132	90	28	60	M16	179	180	128,5	150	22	28	300	250	350	635	150	250	218	336	435	665	764	163	648	231	242
		132																		5			300	257	445	553	774	882	194	679	271	283	
		160												204									350	315	539	640	893	994	241	726	317	322	
		180																			5			350	354	613	734	967	1088	278	763	376	366
200	B5	132	360	320	635	-	250	162	100	35	80	4)	225	225	158	180	27	34	350	300	400	765	167	300	257	445	553	837	945	194	779	386	398
		160																		5			350	315	539	640	931	1032	241	826	432	437	
		180												255									400	354	654	734	1005	1126	278	863	491	481	
		200																			5			450	354	654	734	1046	1126	278	863	517	505
225	B5	132	385	320	660	223	250	162	110	35	80	M20	225	225	158	180	27	34	400	350	450	790	180	300	257	445	553	850	958	194	804	417	429
		160																		5			350	315	539	640	944	1045	241	851	463	468	
		180												255									350	354	613	734	1018	1139	278	888	522	512	
		200																			5			400	354	654	734	1059	1139	278	888	548	536
250	B5	160	450	396	791	-	310	200	125	45	110	4)	260	280	195	225	33	42	500	450	550	955	206	350	315	539	640	1005	1106	241	971	666	671
		180																		5			350	354	613	734	1079	1200	278	1008	725	715	
		200												290									400	354	654	734	1120	1200	278	1008	751	739	
		225																			5			450	411	710	-	1206	-	298	1028	842	-
280	B5	160	480	396	821	277	310	200	140	45	110	M24	260	280	195	225	33	42	500	450	550	985	222	350	315	539	640	1021	1122	241	1001	720	725
		180																		5			350	354	613	734	1095	1216	278	1038	779	769	
		200												290									400	354	654	734	1136	1216	278	1038	805	793	
		225																			5			450	411	710	-	1222	-	298	1058	896	-
320	B5	200	570	510	1005	-	386	245	160	55	110	4)	326	355	241	280	39	52	600	550	660	1205	254	400	411	710	734	1234	1314	278	1205	1163	1151
		225																		6			450	411	710	-	1290	-	298	1223	1254	-	
		250												336									550	411	735	-	1325	-	298	1223	1277	-	
		280																			6			550	490	819	-	1409	-	360	1285	1463	-
360	B5	200	610	510	1045	358	386	245	180	55	110	M30	326	355	241	280	39	52	600	550	660	1245	273	400	354	654	734	1253	1333	278	1245	1258	1246
		225																		6			450	411	710	-	1309	-	298	1263	1349	-	
		250												336									550	411	735	-	1344	-	298	1263	1372	-	
		280																			6			550	490	819	-	1428	-	360	1325	1558	-
315 ³⁾	B5	315											356									660	604	604	962	-	1591	-	445	1410	1806	-	

* Machined surface and N.4 threaded holes (dimensions in ch. 6 «Gear reducer input face»).

1) Working length of thread 2 · F.

2) Values valid for brake motor.

3) For mounting position **B5R** (see ch. 1.2), brake motor is not possible. Moreover for size **315S** the following dimensions will be reduced **X**: ∅490, dimension **Y**: 820, dimension **W**: 360, mass: 1102 kg.

4) For dimension, number and angular position see ch. 6.



12 - Dimensions, designs, mounting positions (helical garmotors)

Designs¹⁾ (direction of rotation)

MR 3I 40 ... 125

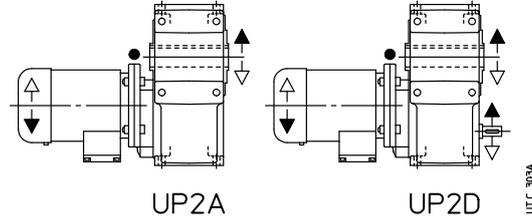

MR 3I 140 ... 360

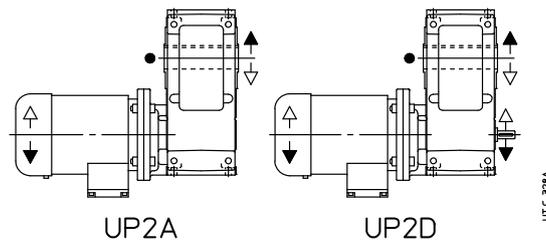

● Position of reference groove (see ch. 6) for radial load verification.
1) For motor design see ch. 2.

12 - Dimensions, designs, mounting positions (helical gearmotors)

Mounting positions

Unless otherwise stated, gear reducers are supplied in mounting position **B3** (see ch. 2).

MR 3I 40 ... 125

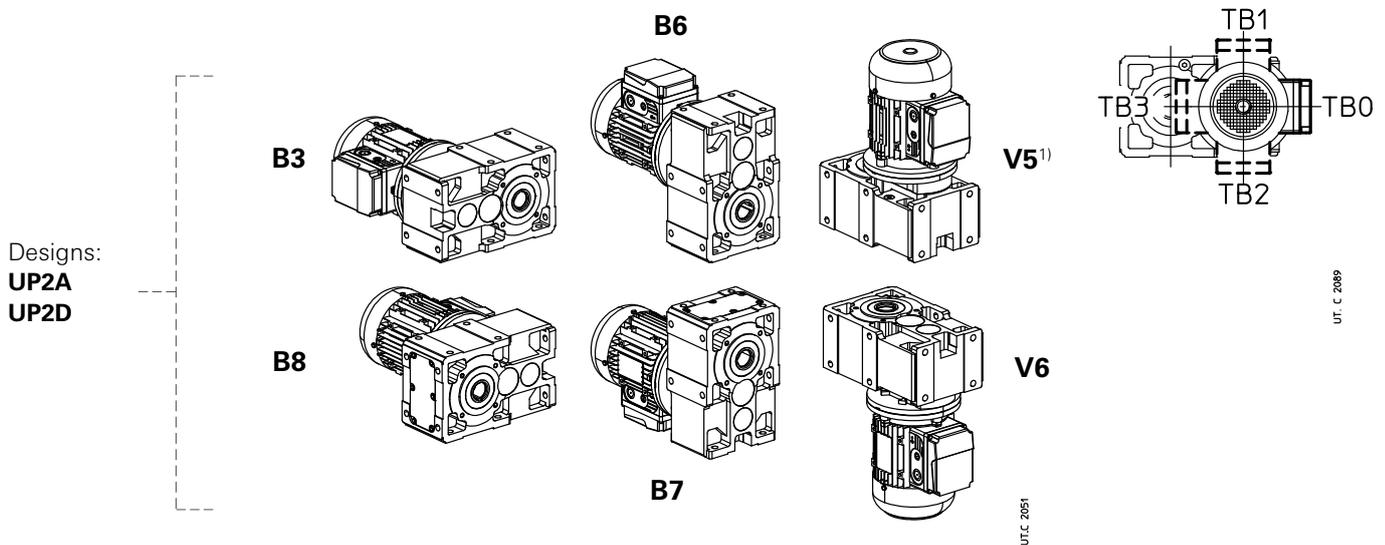

MR 3I 140 ... 360

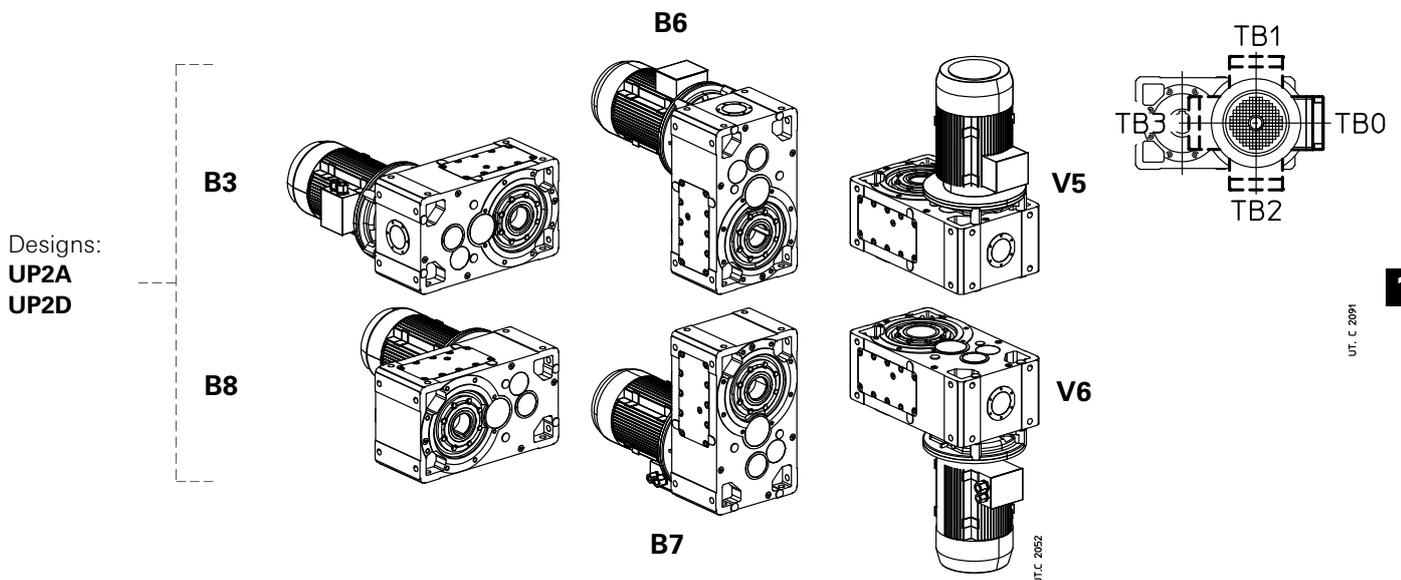

Oil quantity MR 3I 40 ... 360

Lubricant quantities [l] stated in the table are approximate for provisioning. The exact oil quantity the gear reducer is to be filled with is defined by the level plug.

Mounting position	40	50	63, 64	80, 81	100	125	140	160	180	200	225	250	280	320, 321	360
B3	0,47	0,7	1	1,7	3,3	6,1	6,6	12	13	25	26	47	51	97	100
B8	0,47	0,7	1	1,7	3,3	6,1	9,7	18	19	35	37	67	72	137	140
B6	0,55	1,05	1,5	2,9	5,7	10,2	9,7	18	19	35	37	67	72	137	140
B7	0,55	0,9	1,3	2,5	4,9	8,8	9,7	18	19	35	37	67	72	137	140
V5¹⁾	0,55	0,9	1,3	2,5	4,9	8,8	9,7	18	19	35	37	67	72	137	140
V6	0,55	0,9	1,3	2,5	4,9	8,8	9,7	18	19	35	37	67	72	137	140

1) For sizes 40 ... 125, the first reduction stage is grease lubricated «for life» (quantity 5% the oil one).

12 - Dimensions, designs, mounting positions (helical gearmotors)

Lubrication details

MR 3I 100, 125

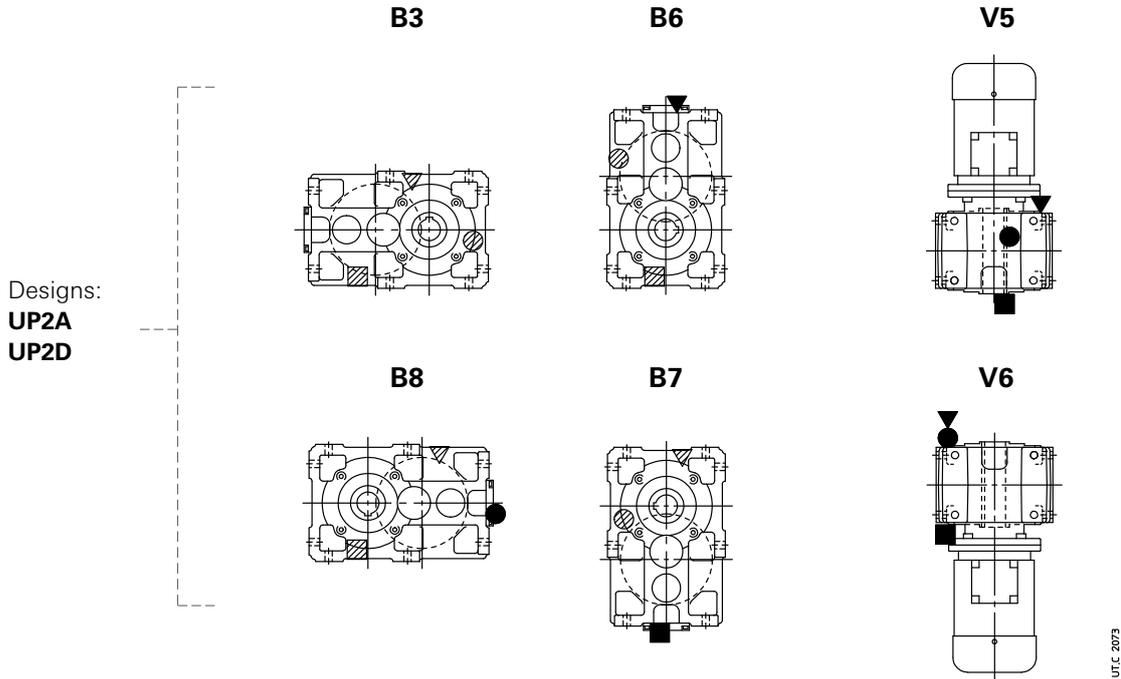

MR 3I 140 ... 360

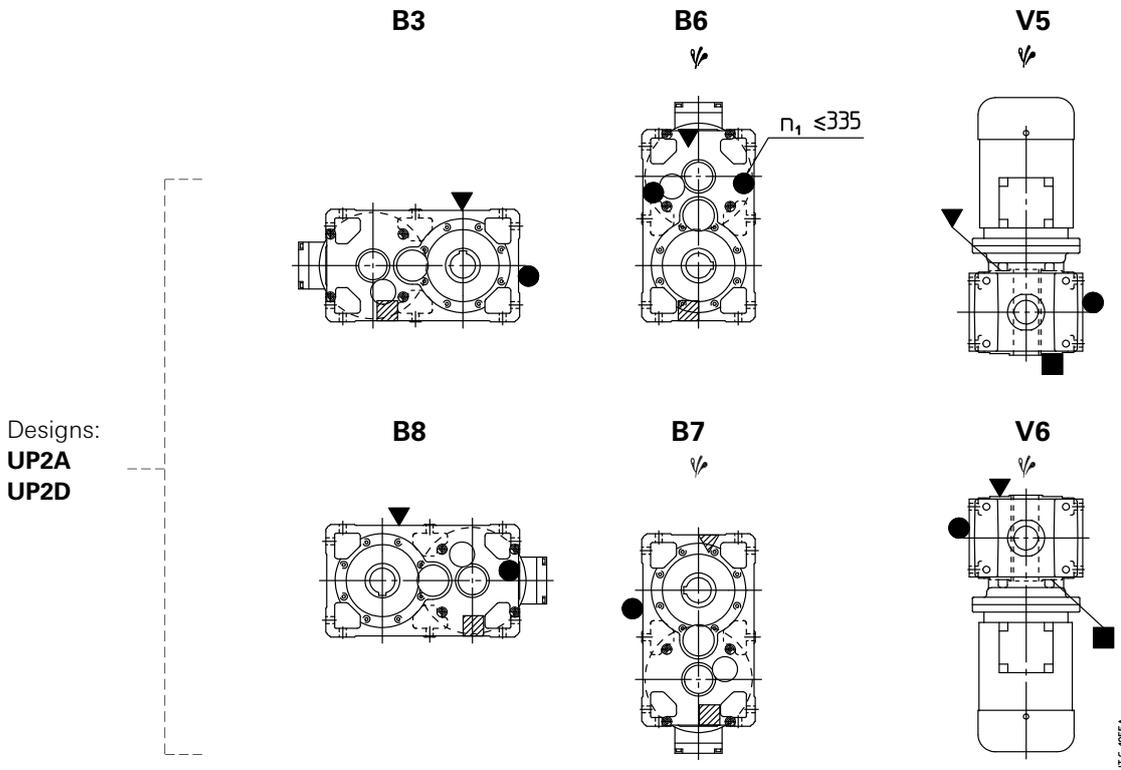

▽ Possible high oil splash: for the corrective factor ft_3 of nominal thermal power P_{tN} see ch. 4.

- ▼ oil filler plug
- oil level plug
- oil drain plug
- oil filler plug with oil dip stick

- ▽ oil filler plug on opposite side (not in view)
- oil level plug on opposite side (not in view)
- oil drain plug on opposite side (not in view)

This page is intentionally left blank.

12 - Dimensions, designs, mounting positions (helical gearmotors)

12.3 - Gearmotors MR 4I

Dimensions

MR 4I 63 ... 125

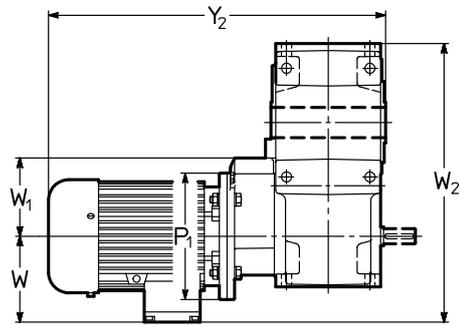
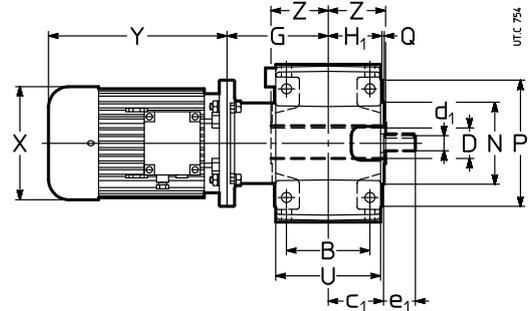
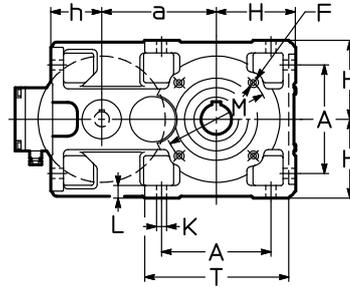
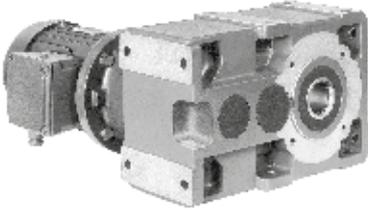

Size		a	A	B	c ₁	D Ø H7	d ₁ Ø	e ₁	F	G	H	H ₁	h	K Ø	L	M Ø	N Ø h6	P Ø	Q	T	U	Z	P ₁ Ø	X Ø	Y	Y ₂	W	W ₁	W ₂	kg			
Gear red.	Motor																																
	B5																																
		1)																															
63	63	113	102	90	61	30	16	30	M8	109	80	58,5	62	11,5	14	100	80	120	3	143	114	63	140	123	189	244	361	416	95	80	290	24	26
64	71	(63)				(63)																	160	138	216	278	388	450	112	80	307	27	30
		115				32																	200	156	233	302	426	488	121	100	364	41	45
		(64)				(64)																	200	176	287	366	540	619	141	125	446	70	76
80	71	142,5	132	106	72	38	19	40	M10	135	100	69,5	70	14	17	130	110	160	3,5	180	135	75	160	138	216	278	426	488	112	100	355	36	39
81	80					(80)																	200	156	233	302	443	512	121	100	364	41	45
						40																	200	156	233	302	443	512	121	100	364	41	45
						(81)																	200	156	233	302	443	512	121	100	364	41	45
100	80	180	172	131	87	48	24	50	M12	163	125	84,5	80	16	20	165	130	200	3,5	228	165	90	200	156	233	302	486	555	121	125	426	64	68
	90																						200	176	287	366	540	619	141	125	446	70	76
																							200	176	287	366	540	619	141	125	446	70	76
125	90	225	212	162	107	60	28	60	M12	203	150	103,5	100	18	23	215	180	250	4	274	201	110	200	176	287	366	600	679	141	166	516	112	118
	100																						250	194	310	405	623	718	151	166	526	116	123
	112																						250	218	336	435	649	748	163	166	538	129	138

1) Working length of thread 2 · F.
 2) Values valid for brake motor.
 3) For dimension, number and angular position see ch. 6.



12 - Dimensions, designs, mounting positions (helical gearmotors)

Designs¹⁾ (direction of rotation)

MR 4I 63 ... 125

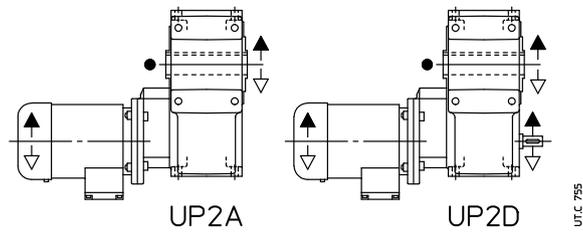

● Position of reference groove (see ch.18) for radial load verification.
1) For motor design see ch. 2.

12 - Dimensions, designs, mounting positions (helical gearmotors)

Mounting positions

Unless otherwise stated, gear reducers are supplied in mounting position **B3** (see ch. 2).

MR 4I 63 ... 125

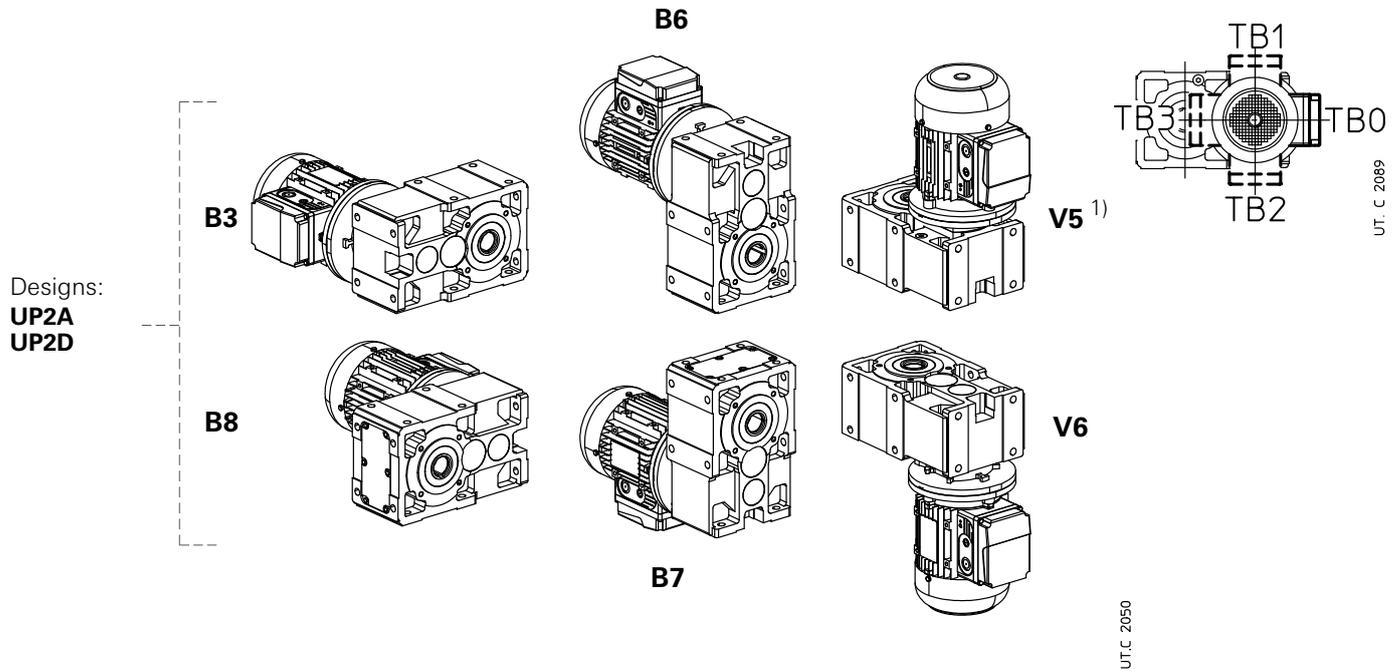

12

Oil quantity MR 4I 63 ... 125

Lubricant quantities [l] stated in the table are approximate for provisioning. The exact oil quantity the gear reducer is to be filled with is defined by the level plug.

Mounting position	63, 64	80, 81	100	125
B3	1,1	1,9	3,6	6,6
B8	1,1	1,9	3,6	6,6
B6	1,8	3,2	6	10,7
B7	1,4	2,7	5,3	9,4
V5 ¹⁾	1,3	2,5	4,9	8,8
V6	1,4	2,7	5,3	9,4

1) The first 2 reduction stages lubricated «for life» with grease (10% oil quantity).

Lubrication details

MR 4I 100, 125

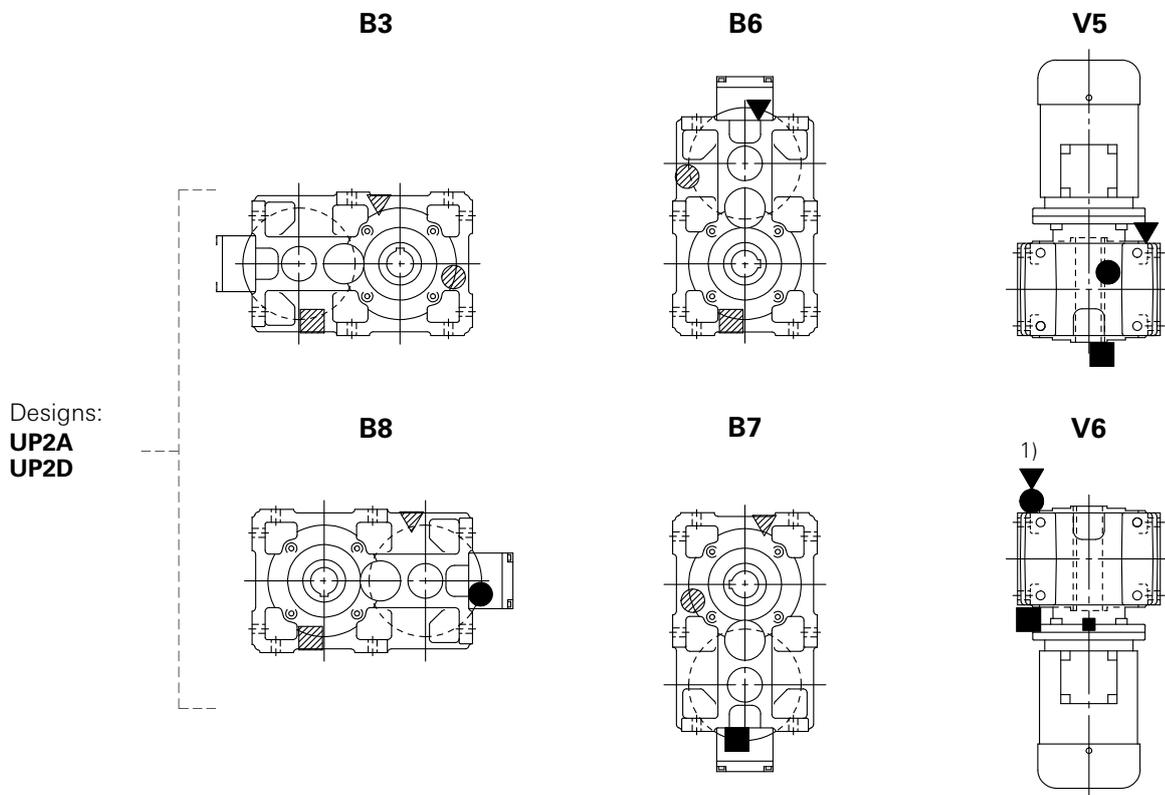

1) See also ch. 6 page 43.

- ▼ oil filler plug
- oil level plug
- oil drain plug
- oil filler plug with oil level dip stick
- ▼ oil drain plug on opposite side (not in view)
- oil level plug on opposite side (not in view)
- oil drain plug on opposite side (not in view)

12 - Dimensions, designs, mounting positions (helical gearmotors)

12.4 - Gearmotors MR 2I – Long model

Dimensions

MR 2I 100, 125 – Long model

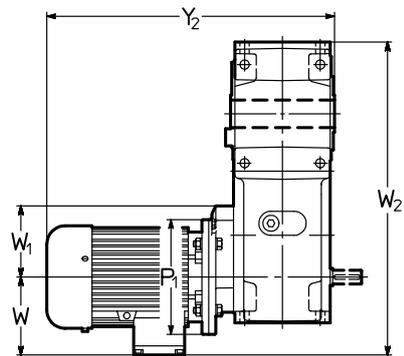
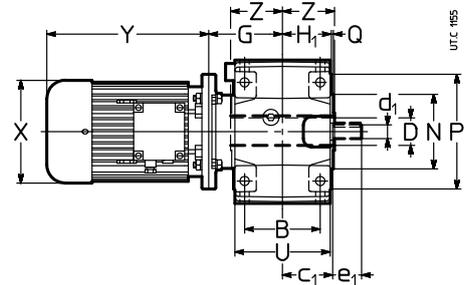
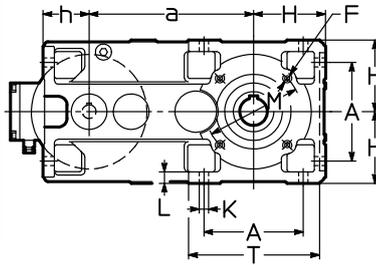

Size	a	A	B	c ₁	D Ø H7	d ₁ Ø	e ₁	F	G	H	H ₁	h	K	L	M	N	P	Q	T	U	Z	P ₁ Ø	X	Y	Y ₂	W	W ₁	W ₂	kg				
Gear red.										h11	h11		Ø	Ø	Ø h6	Ø						Ø	Ø	≈	≈	≈	≈	≈	≈	2)			
Motor																														2)			
100	90	284,7	172	131	87	48	24	50	M12	130	125	84,5	80,3	16	20	165	130	200	3,5	228	165	90	200	176	287	366	507	586	141	125	551	76	82
	100																						250	194	310	405	530	625	151	125	561	80	87
	112																						250	218	336	435	556	655	163	125	573	93	102
	132⁴⁾															150							300	257	445	553	685	793	194	150	604	128	140
125	112	358	212	162	107	60	28	60	3)	159	150	103,5	100	18	23	215	180	250	4	274	201	110	250	218	336	435	605	704	163	166	671	134	143
	132									164													300	257	445	553	719	827	194	166	702	169	181
	160									179													350	315	539	640	828	929	241	175	749	215	220
	180																						350	354	613	734	902	1023	278	175	786	274	264

1) Working length of thread 2 · F.
 2) Values valid for brake motor.
 3) For dimension, number and angular position see ch. 6.
 4) On request for 100LB 4, 112M 4 and 132M 4 also mounting position **B5R** (see ch. 1.2; dimensions Y and Y₂ increase by 27 mm, 26 mm and 35 mm, respectively).



12 - Dimensions, designs, mounting positions (helical gearmotors)

MR 2I 140 ... 225 – Long model

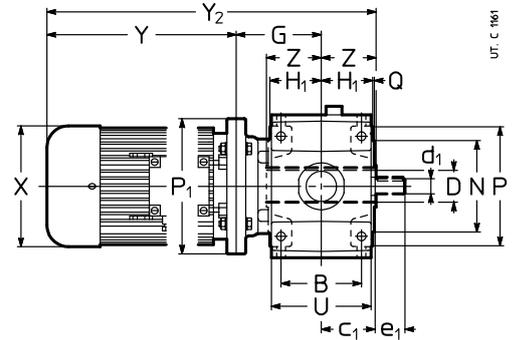
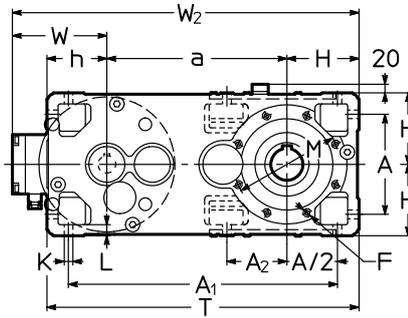
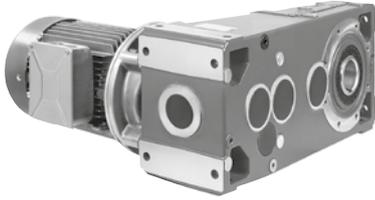

UT. C 1161

Size	Gear red.	Motor B5	a	A	A ₁	A ₂	B	c ₁	D ∅ H7	d ∅	e ₁	F	G	H	H ₁	h	K ∅	L	M ∅	N ∅ h6	P ∅	T	Z	P ∅	X ∅ ≈	Y ≈	Y _{z2} ≈	W ≈	W _{z2} ≈	kg			
			1)	h11	h11	∅	∅	∅	∅	∅	∅	∅	∅	∅	∅	∅	∅	∅	∅	∅	∅	∅	∅	∅	∅	∅	∅	∅	∅	∅	∅	∅	
140		132	373	212	560	127	162	107	70	28	60	4)	159	150	103,5	125	18	23	265	230	300	648	125	300	257	445	553	729	837	194	717	201	213
		160											179											350	315	539	640	843	944	241	764	247	252
		180																						350	354	613	734	917	1038	278	801	306	296
		200																						350	354	654	734	958	1038	278	801	332	320
160		160	450	252	672	-	201	132	80	38	80	M16	204	180	128,5	150	22	28	265	230	300	780	136	350	315	539	640	879	980	241	871	327	332
		180											194							230	300	800	249	350	354	613	734	953	1074	278	908	386	376
		200											224							4				400	354	654	734	984	1064	278	908	412	400
		225												224										450	411	710	-	1070	-	298	928	503	-
180		180	470	252	692	170	201	132	90	38	80	M16	204	180	128,5	150	22	28	300	250	350	800	150	350	354	613	734	967	1088	278	928	404	394
		200											194							5				400	354	654	734	998	1078	278	928	430	418
		225											224											450	411	710	-	1084	-	298	948	521	-
		250																						450	411	735	-	1109	-	298	948	544	-
200		200	556	320	831	-	250	162	100	48	110	4)	225	225	158,0	180	27	34	350	300	400	961	167	400	354	654	734	1046	1126	278	1059	565	553
		225											255							5				450	411	710	-	1132	-	298	1079	656	-
		250																						550	411	735	-	1157	-	298	1079	679	-
		280																						550	490	819	-	1241	-	360	1141	865	-
225		225	581	320	856	223	250	162	110	48	110	M20	255	225	158,0	180	27	34	400	350	450	986	180	450	411	710	-	1145	-	298	1104	688	-
		250																						550	411	735	-	1170	-	298	1104	711	-
		280																						550	490	819	-	1254	-	360	1166	897	-
		315 ³⁾																						550	490	820	-	1255	-	360	1166	858	-

1) Working length of thread 2 · F.
 2) Values valid for brake motor.
 3) Mounting position **B5R** (see ch. 1.2), brake motor is not possible. Moreover for size **315S** the following dimensions will be reduced: dimension **X**: ∅ 490, dimension **Y**: 820, dimension **W**: 360, mass: 1102 kg.
 4) For dimension, number and angular position see ch. 6.



12 - Dimensions, designs, mounting positions (helical gearmotors)

Designs¹⁾ (direction of rotation)

MR 2I 100, 125 – Long model

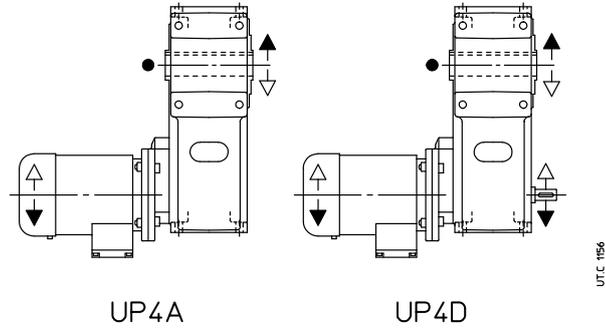

MR 2I 140 ... 225 – Long model

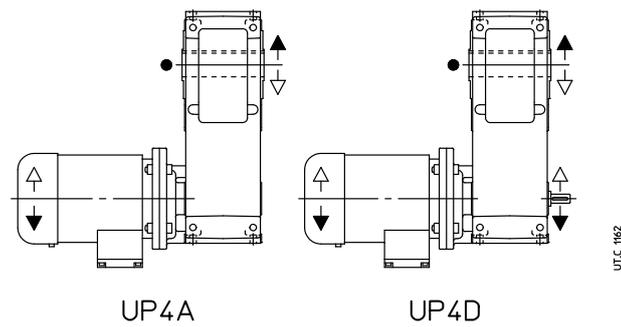

● Position of reference groove (see ch. 6) for radial load verification.
1) For motor design see ch. 2.

12 - Dimensions, designs, mounting positions (helical gearmotors)

Mounting positions

Unless otherwise stated, gear reducers are supplied in mounting position **B3** (see ch. 2).

MR 2I 100, 125 – Long model

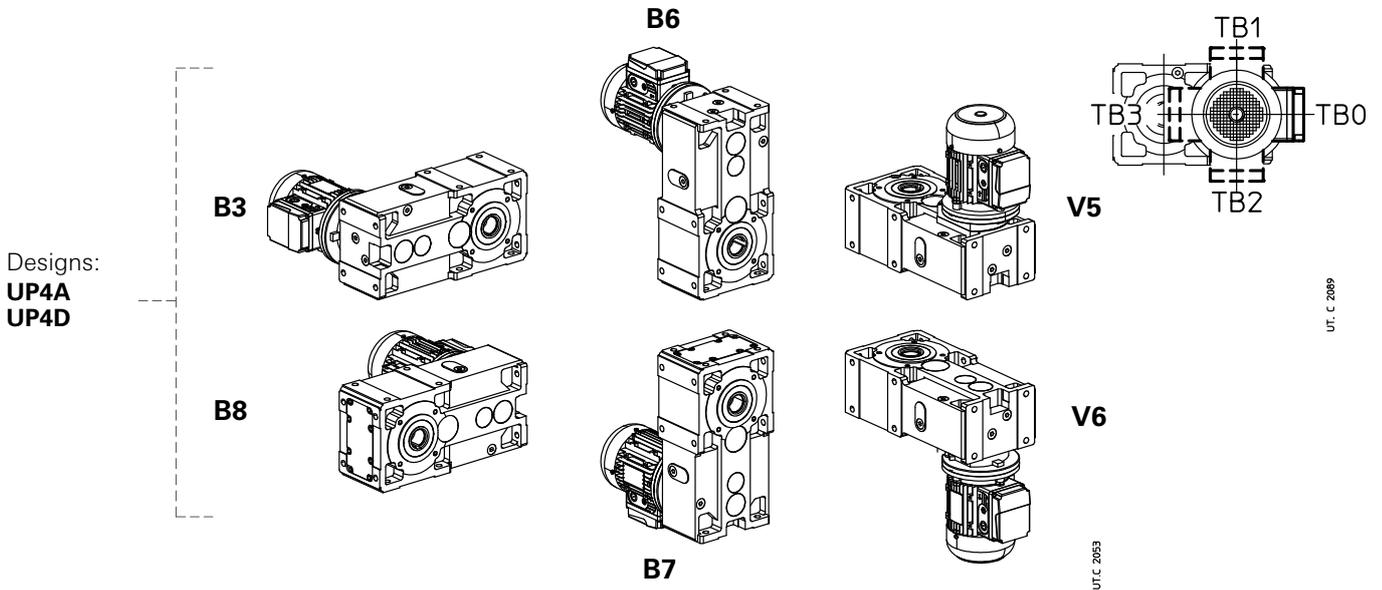

MR 2I 140 ...225 – Long model

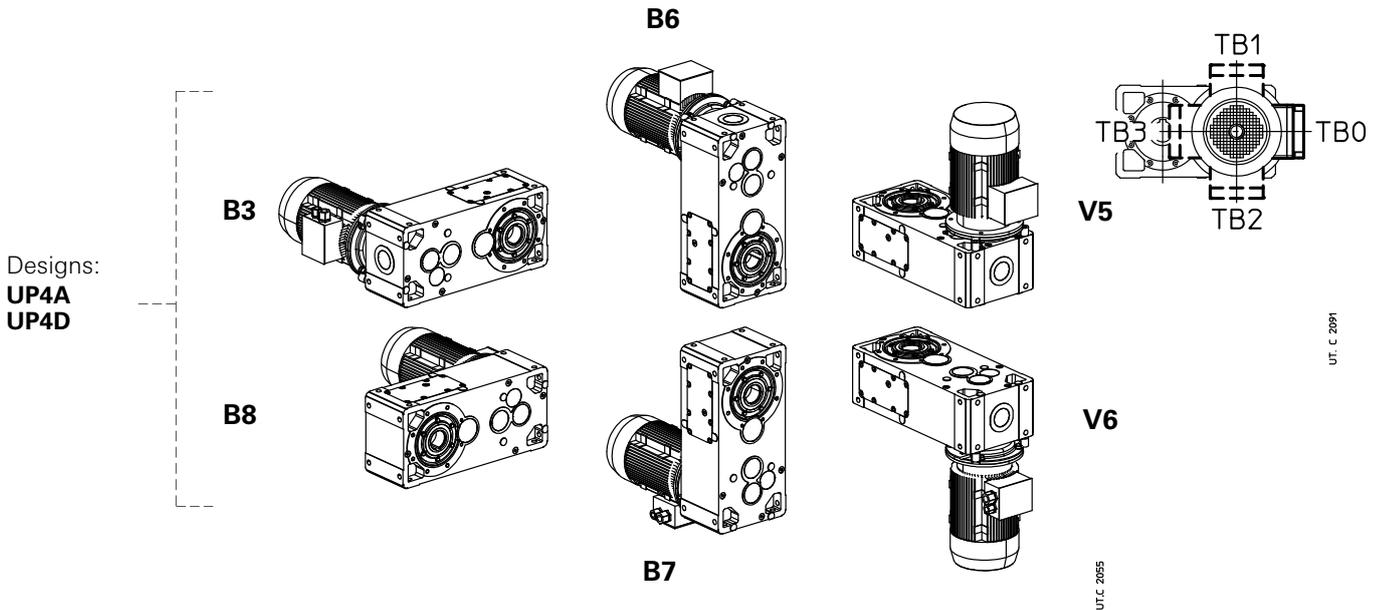

Oil quantity MR 2I 100 ... 225 – Long model

Lubricant quantities [l] stated in the table are approximate for provisioning. The exact oil quantity the gear reducer is to be filled with is defined by the level plug.

Mounting position	100	125	140	160	180	200	225
B3	4,2	8	8,8	16	17,4	33	34
B8	4,2	8	12	20	21	38	40
B7	7,6	14	15,6	28	29,4	55	57
B6	7,6	14	15,6	28	29,4	55	57
V5	6,6	12	13,6	24	25,4	48	50
V6	6,6	12	13,6	24	25,4	48	50

12 - Dimensions, designs, mounting positions (helical gearmotors)

Lubrication details

MR 2I 100, 125 – Long model

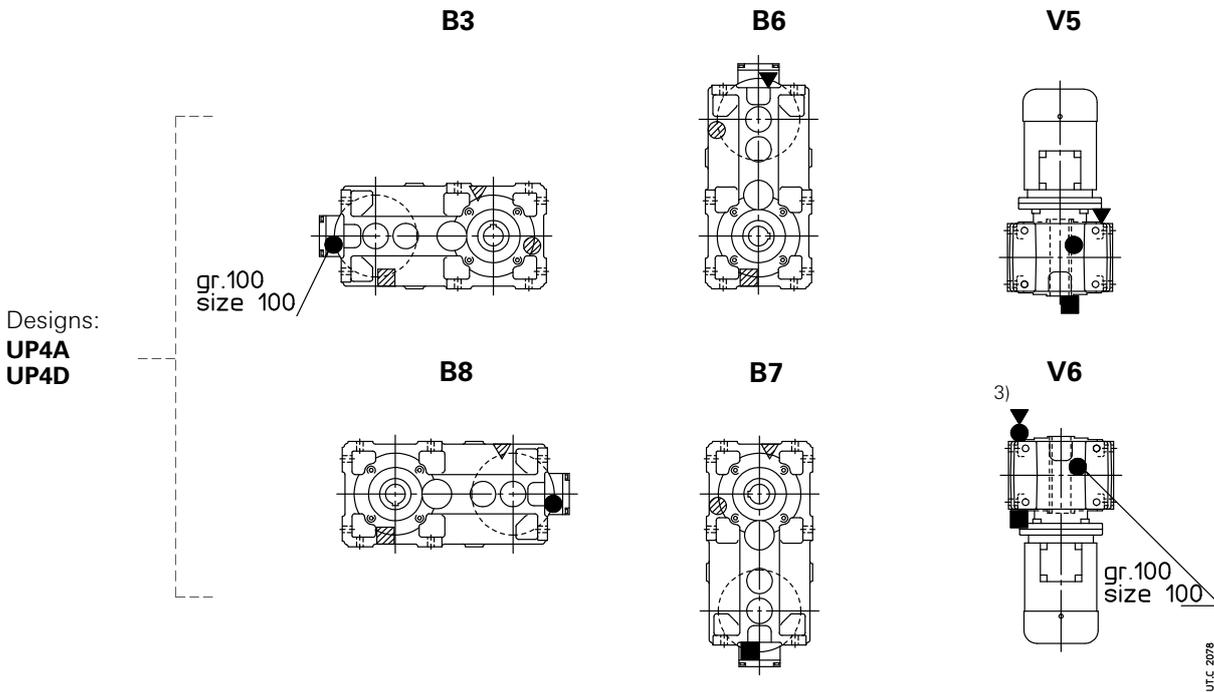

MR 2I 140 ... 225 – Long model

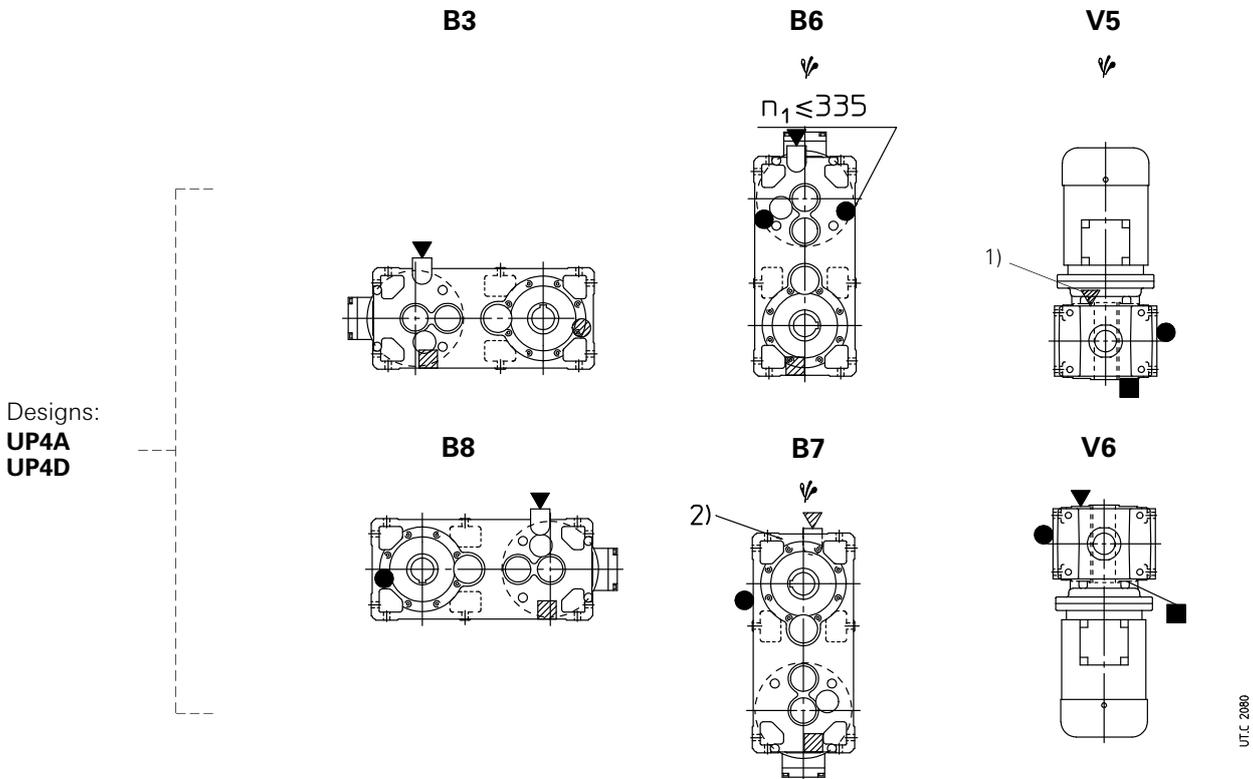

1) Oil filler plug possible also on low speed shaft side.

2) Oil filler plug possible also on opposite side.

3) See also ch. 6 page. 43.

▽ Possible high oil splash: for the corrective factor f_{t_3} of nominal thermal power P_{t_N} see ch. 4.

▼ oil filler plug

● oil level plug

■ oil drain plug

● oil filler plug with oil level dip stick

▽ oil filler plug on opposite side (not in view)

● oil level plug on opposite side (not in view)

■ oil drain plug on opposite side (not in view)

This page is intentionally left blank.

12 - Dimensions, designs, mounting positions (helical gearmotors)

12.5 - Gearmotors MR 3I – Long model

Dimensions

MR 3I 100, 125 – Long model

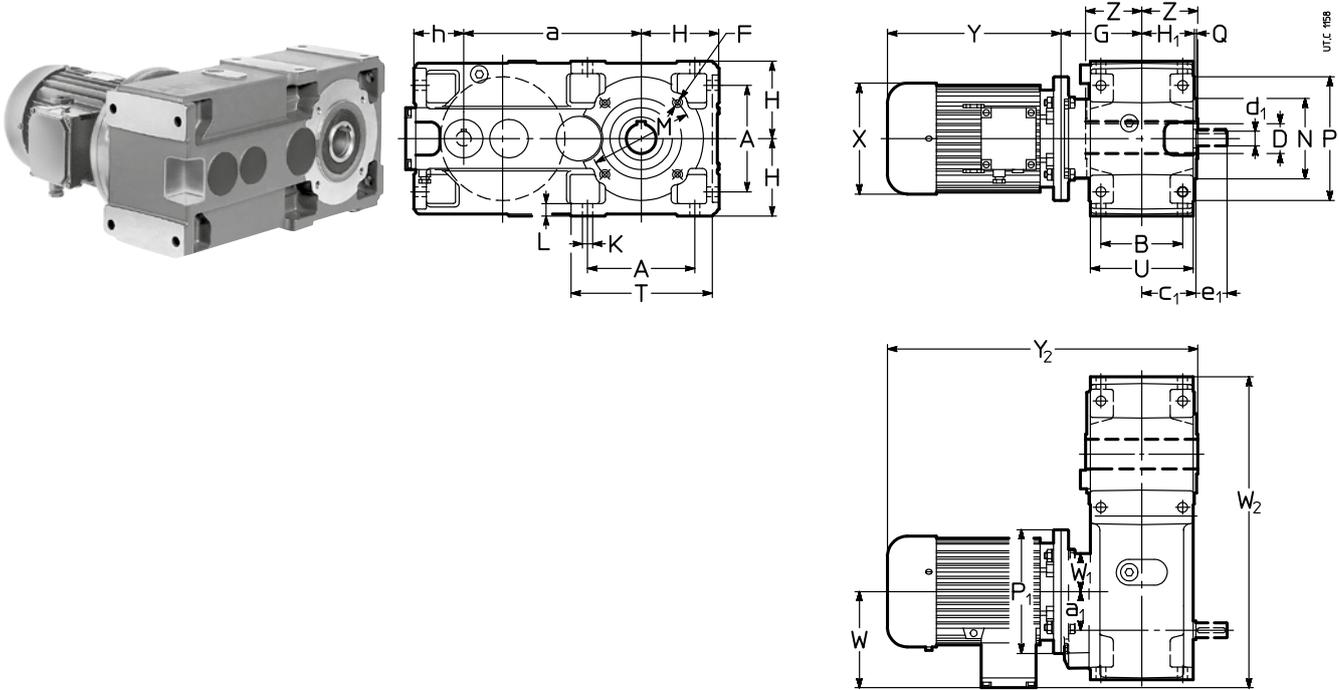

12	Size		a	A	B	c ₁	D Ø H7	d ₁ Ø	e ₁	F	G	H	H ₁	h h11	K Ø	L	M Ø	N Ø h6	P Ø	Q	T	U	Z	P ₁ Ø	X Ø	Y	Y ₂	W	W ₁	W ₂	kg			
	Gear red.	Motor B5	a ₁						1)																	2)	2)				2)			
100	80		284,7	172	131	87	48	24	50	M12	130	125	84,5	80,3	16	20	165	130	200	3,5	228	165	90	200	156	233	302	453	522	121	62	490	71	75
	90		63																					200	176	287	366	507	586	141	62	490	77	83
	100																							250	194	310	405	530	625	151	62	498	81	88
	112																							250	218	336	435	556	655	163	62	510	94	103
125	90		358,7	212	162	107	60	28	60	3)	159	150	103,5	100	18	23	215	180	250	4,0	274	201	110	200	176	287	366	556	635	141	86	608	125	131
	100		80																					250	194	310	405	579	674	151	86	608	129	136
	112																							250	218	336	435	605	704	163	86	608	142	151
	132										164													300	257	445	553	719	827	194	86	622	177	189

1) Working length of thread 2 · F.
 2) Values valid for brake motor.
 3) For dimension, number and angular position see ch. 6.



12 - Dimensions, designs, mounting positions (helical gearmotors)

MR 3I 140 ... 225 – Long model

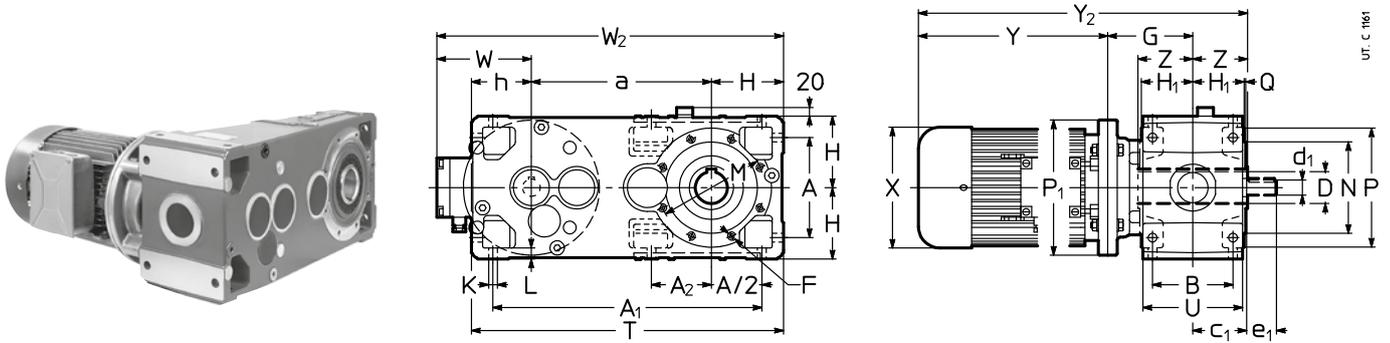

Size	Gear red.	Motor red.	a	A	A ₁	A ₂	B	c ₁	D Ø H7	d Ø	e ₁	F	G	H	H ₁	h h11	K Ø	L	M Ø	N Ø h6	P Ø	T	Z	P ₁ Ø	X Ø ≈	Y ≈	Y ₂ ≈	W ≈	W ₂ ≈	kg		
																															B5	1)
140	100	373	212	560	127	162	107	70	24	50	4)	134	150	103,5	125	18	23	265	230	300	648	125	250	194	310	405	569	664	151	674	153	160
	112											159							230	300	201		300	218	336	435	595	694	163	686	161	172
	132											179							230	300			300	257	445	553	729	837	194	717	201	213
	160 ³⁾																		250	350			300	315	539	640	843	944	241	764	247	252
160	100	450	252	672	-	201	132	80	28	60	M16	179	180	128,5	150	22	28	265	230	300	780	136	250	194	310	405	625	720	151	781	233	240
	112																		230	300	249		250	218	336	435	651	750	163	793	241	252
	132											204							230	300			300	257	445	553	760	868	194	824	281	293
	160																		250	350			350	315	539	640	879	980	241	871	327	332
	180																		230	350			350	354	613	734	953	1074	278	908	386	376
180	112	470	252	692	170	201	132	90	28	60	M16	179	180	128,5	150	22	28	300	250	350	800	150	250	218	336	435	665	764	163	813	259	270
	132																		250	300	249		300	257	445	553	774	882	194	844	299	311
	160											204							250	350			350	315	539	640	893	994	241	891	345	350
	180																		250	350			350	354	613	734	967	1088	278	928	404	394
	200 ³⁾																		250	350			350	354	654	734	998	1078	278	928	430	418
200	132	556	320	831	-	250	162	100	38	80	4)	225	225	158,0	180	27	34	350	300	400	961	167	300	257	445	553	837	945	194	975	434	446
	160																		300	350	307		350	315	539	640	931	1032	241	1022	480	485
	180																		300	350			350	354	613	734	1005	1126	278	1059	539	529
	200																		300	350			400	354	654	734	1046	1126	278	1059	565	553
	225																		300	350			450	411	710	734	1132	1132	298	1079	656	-
225	132	581	320	856	223	250	162	110	38	80	M20	225	225	158,0	180	27	34	400	350	450	986	180	300	257	445	553	850	958	194	1000	466	478
	160																		300	350	307		350	315	539	640	944	1045	241	1047	512	517
	180																		300	350			350	354	613	734	1018	1139	278	1084	571	561
	200																		300	350			400	354	654	734	1059	1139	278	1084	597	585
	225 ³⁾																		300	350			450	411	710	-	1145	-	298	1104	688	-
																			300	350			450	411	710	-	1145	-	298	1104	711	-

1) Working length of thread 2 · F.
 2) Values valid for brake motor.
 3) Mounting position **B5R** (see ch. 1.2).
 4) For dimension, number and angular position see ch. 6.



12 - Dimensions, designs, mounting positions (helical gearmotors)

Designs¹⁾ (direction of rotation)

MR 3I 100, 125 – Long model

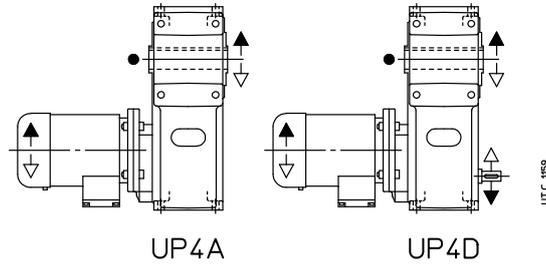

MR 3I 140 ... 225 – Long model

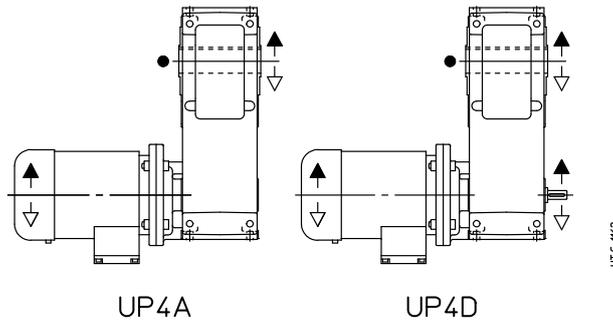

● Position of reference groove (see ch. 6) for radial load verification.
1) For motor design see ch. 2.

12 - Dimensions, designs, mounting positions (helical gearmotors)

Mounting positions

Unless otherwise stated, gear reducers are supplied in mounting position **B3** (see ch. 2).

MR 3I 100 ... 125 – Long model

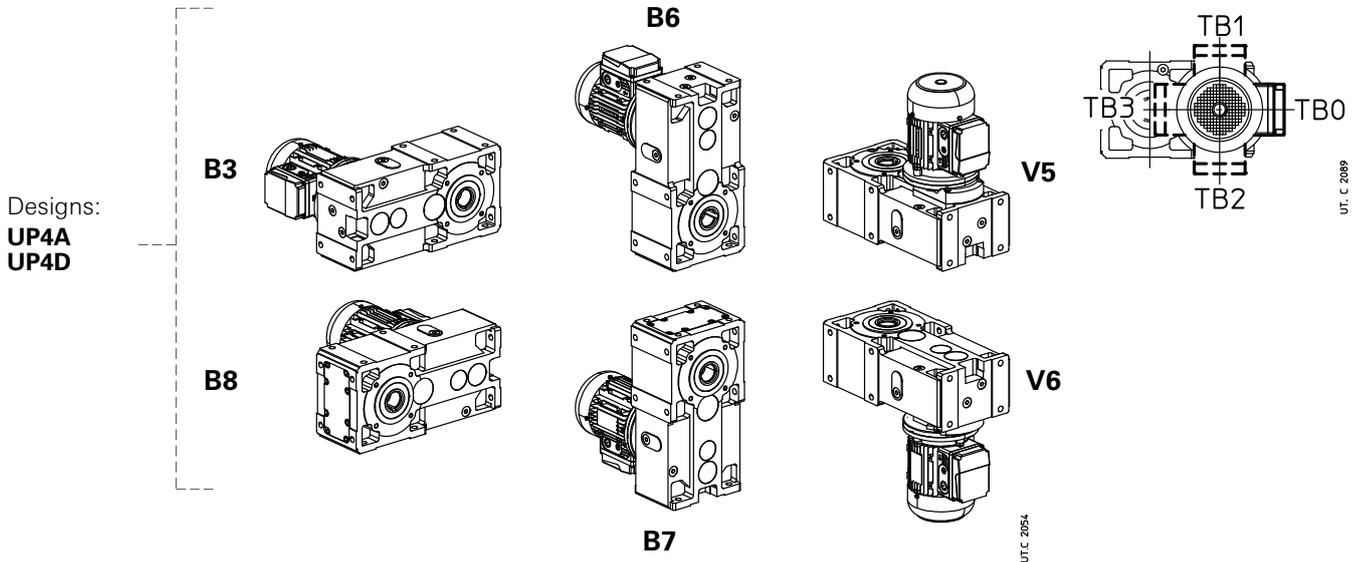

MR 3I 140 ... 225 – Long model

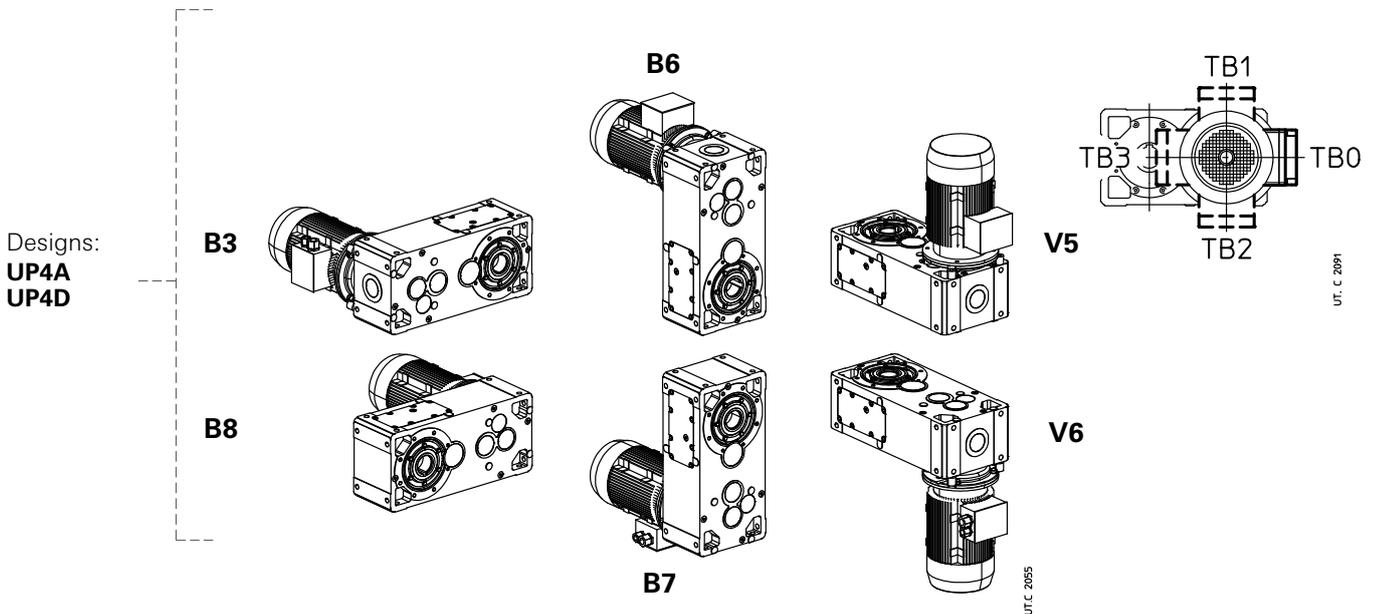

Oil quantity MR 3I 100 ... 225 – Long model

Lubricant quantities [l] stated in the table are approximate for provisioning. The exact oil quantity the gear reducer is to be filled with is defined by the level plug.

Mounting position	100	125	140	160	180	200	225
B3	4,3	8,3	8,8	16	17,4	33	34
B8	4,3	8,3	12,6	22	23,4	44	46
B6	8,3	16	15,6	28	29,4	55	57
B7	8,3	16	15,6	28	29,4	55	57
V5	6,5	12	13,6	24	25,4	48	50
V6	6,5	12	13,6	24	25,4	48	50

12 - Dimensions, designs, mounting positions (helical gearmotors)

Lubrication details

MR 3I 100, 125 – Long model

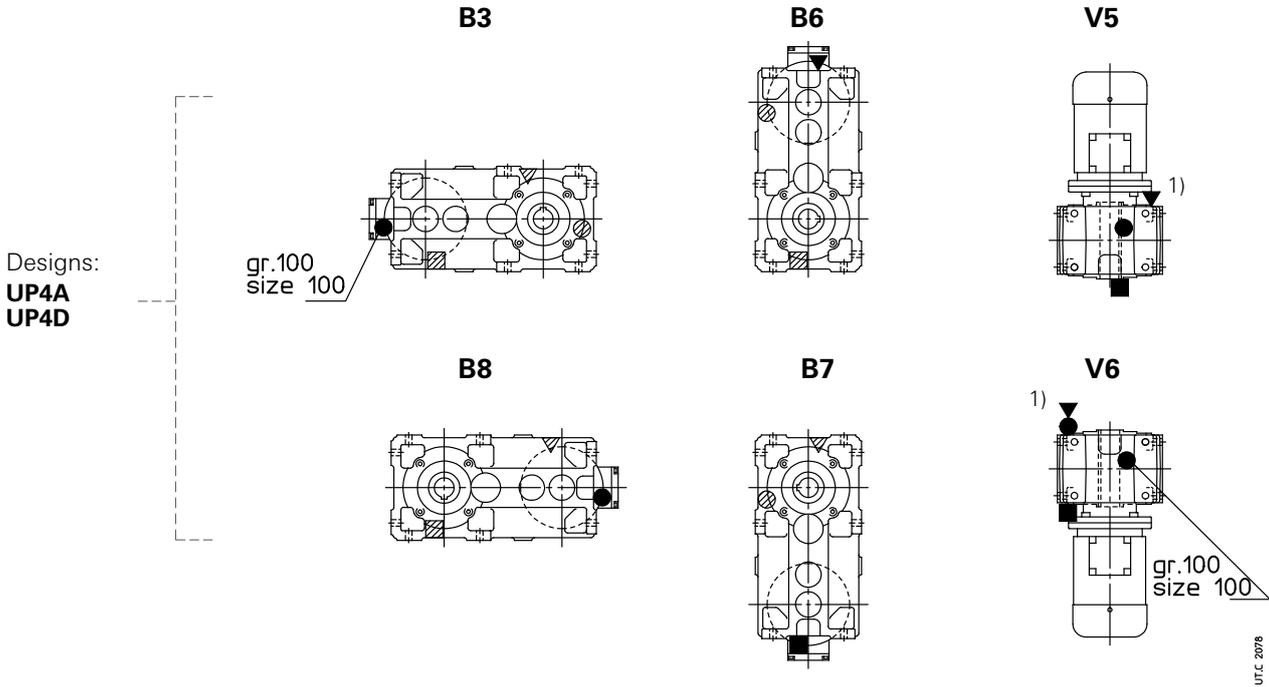

MR 3I 140 ... 225 – Long model

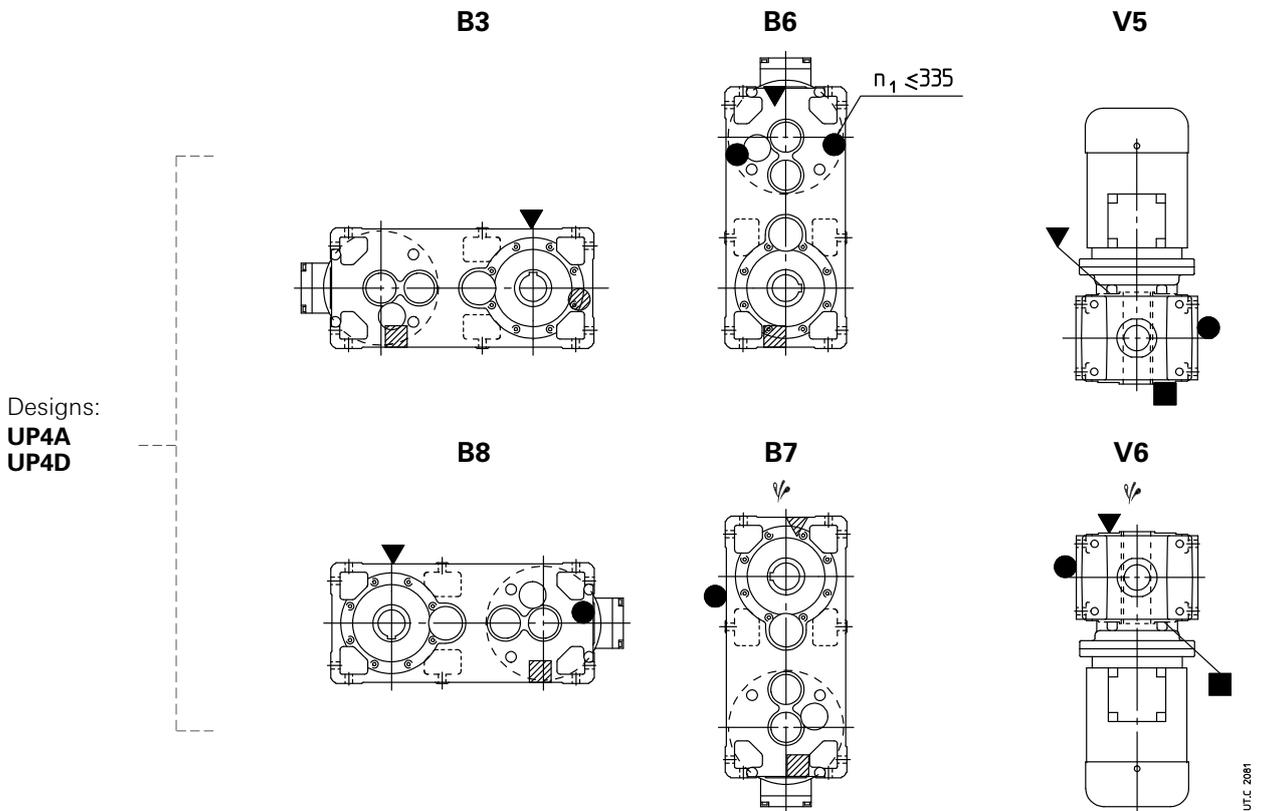

▽ Possible high oil splash: for the corrective factor f_t of nominal thermal power P_{tN} see ch. 4.

1) See also ch. 6 page 43.

- ▼ oil filler plug
- oil level plug
- oil drain plug
- oil filler plug with oil level dip stick
- ▽ oil filler plug on opposite side (not in view)
- oil level plug on opposite side (not in view)
- oil drain plug on opposite side (not in view)

13 – Selection tables

(bevel helical gearmotors)

13 - Selection tables (bevel helical gearmotors)

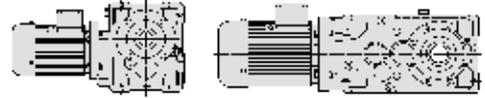

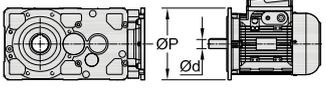
P_1 kW	n_2 min ⁻¹	M_2 N m	f_s		i	
1)				2)		
0,09	4,28	185	1	MR C3I 50 - 11 x 140 63 A	6 210	
	5,25	151	1,18	MR C3I 50 - 11 x 140 63 A	6 171	
	6,66	119	1,7	MR C3I 50 - 11 x 140 63 A	6 135	
	10,7	76	2,12	MR ICI 50 - 11 x 140 63 A	6 84,3	
	11,9	68	1,06	MR ICI 40 - 11 x 140 63 A	6 75,8	
	13,3	61	2,65	MR ICI 50 - 11 x 140 63 A	6 67,5	
	14,4	56	1,18	MR ICI 40 - 11 x 140 63 A	6 62,5	
	16,4	49,3	3,35	MR ICI 50 - 11 x 140 63 A	6 54,9	
	18,8	42,9	2	MR ICI 40 - 11 x 140 63 A	6 47,8	
	22,8	35,4	2,65	MR ICI 40 - 11 x 140 63 A	6 39,4	
	29,5	27,4	2,65	MR ICI 40 - 11 x 140 63 A	6 30,5	
	34,4	24	2,8	MR CI 40 - 11 x 140 63 A	6 26,2	
	41,5	19,9	3,55	MR CI 40 - 11 x 140 63 A	6 21,7	
	50,4	16,4	4	MR CI 40 - 11 x 140 63 A	6 17,9	
	65,9	12,5	6,7	MR CI 40 - 11 x 140 63 A	6 13,7	
	79,9	10,3	8,5	MR CI 40 - 11 x 140 63 A	6 11,3	
	0,12	5,25	201	0,85	MR C3I 50 - 11 x 140 63 B	6 171
		6,66	158	1,12	MR C3I 50 - 11 x 140 63 A	4 210
		6,66	158	1,32	MR C3I 50 - 11 x 140 63 B	6 135
8,17		129	1,32	MR C3I 50 - 11 x 140 63 A	4 171	
10,4		102	2	MR C3I 50 - 11 x 140 63 A	4 135	
10,7		101	1,6	MR ICI 50 - 11 x 140 63 B	6 84,3	
11,9		91	0,8	MR ICI 40 - 11 x 140 63 B	6 75,8	
13,3		81	2	MR ICI 50 - 11 x 140 63 B	6 67,5	
14,4		75	0,9	MR ICI 40 - 11 x 140 63 B	6 62,5	
16,6		65	2,36	MR ICI 50 - 11 x 140 63 A	4 84,3	
18,5		58	1,18	MR ICI 40 - 11 x 140 63 A	4 75,8	
18,8		57	1,5	MR ICI 40 - 11 x 140 63 B	6 47,8	
20,8		52	3	MR ICI 50 - 11 x 140 63 A	4 67,5	
22,4		48,1	1,4	MR ICI 40 - 11 x 140 63 A	4 62,5	
22,8		47,2	2	MR ICI 40 - 11 x 140 63 B	6 39,4	
25,5		42,3	4	MR ICI 50 - 11 x 140 63 A	4 54,9	
29,3		36,8	2,24	MR ICI 40 - 11 x 140 63 A	4 47,8	
34,4		32	2,12	MR CI 40 - 11 x 140 63 B	6 26,2	
35,5		30,3	3	MR ICI 40 - 11 x 140 63 A	4 39,4	
41,5		26,5	2,65	MR CI 40 - 11 x 140 63 B	6 21,7	
45,9		23,5	3	MR ICI 40 - 11 x 140 63 A	4 30,5	
53,5		20,6	3,35	MR CI 40 - 11 x 140 63 A	4 26,2	
64,6		17	4	MR CI 40 - 11 x 140 63 A	4 21,7	
78,4		14	4,5	MR CI 40 - 11 x 140 63 A	4 17,9	
102		10,7	7,5	MR CI 40 - 11 x 140 63 A	4 13,7	
		124	8,9	10	MR CI 40 - 11 x 140 63 A	4 11,3
		161	6,9	10	MR CI 40 - 11 x 140 63 A	4 8,72
0,18	2,29	690	0,9	MR C3I 81 - 14 x 160 71 A	6 393	
	2,74	578	1	MR C3I 80 - 14 x 160 71 A	6 329	
	2,74	578	1,12	MR C3I 81 - 14 x 160 71 A	6 329	
	3,42	463	1,4	MR C3I 80 - 14 x 160 71 A	6 263	
	3,42	463	1,6	MR C3I 81 - 14 x 160 71 A	6 263	
	4,44	356	1,12	MR C3I 64 - 14 x 160 71 A	6 202	
	4,27	370	2	MR C3I 80 - 14 x 160 71 A	6 211	
	4,27	370	2,24	MR C3I 81 - 14 x 160 71 A	6 211	
	5,56	285	1,12	MR C3I 63 - 14 x 160 71 A	6 162	
	5,56	285	1,25	MR C3I 64 - 14 x 160 71 A	6 162	
	5,33	296	2,24	MR C3I 80 - 14 x 160 71 A	6 169	
	7,05	224	1,8	MR C3I 63 - 14 x 160 71 A	6 128	
	7,05	224	2,12	MR C3I 64 - 14 x 160 71 A	6 128	
	7,58	213	1,12	MR ICI 63 - 14 x 160 71 A	6 119	
	7,58	213	1,4	MR ICI 64 - 14 x 160 71 A	6 119	
	7,29	222	2,5	MR ICI 80 - 14 x 160 71 A	6 124	

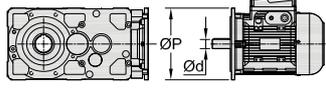
P_1 kW	n_2 min ⁻¹	M_2 N m	f_s		i	
1)				2)		
0,18	8,17	194	0,9	MR C3I 50 - 11 x 140 63 B	4 171	
	9,19	172	1,18	MR C3I 50 - 14 x 160 71 A	6 97,9	
	9,47	171	1,6	MR ICI 63 - 14 x 160 71 A	6 95	
	9,47	171	2	MR ICI 64 - 14 x 160 71 A	6 95	
	9,11	177	3,35	MR ICI 80 - 14 x 160 71 A	6 98,8	
	10,4	153	1,32	MR C3I 50 - 11 x 140 63 B	4 135	
	11,3	143	1,9	MR ICI 63 - 14 x 160 71 A	6 79,5	
	14,7	110	1,4	MR ICI 50 - 14 x 160 71 A	6 61,1	
	14,1	114	2,36	MR ICI 63 - 14 x 160 71 A	6 63,6	
	16,6	97	1,6	MR ICI 50 - 11 x 140 63 B	4 84,3	
	17,7	91	3,35	MR ICI 63 - 14 x 160 71 A	6 50,9	
	18,5	88	0,8	MR ICI 40 - 11 x 140 63 B	4 75,8	
	19,9	81	0,85	MR ICI 40 - 14 x 160 71 A	6 45,3	
	20,8	78	2	MR ICI 50 - 11 x 140 63 B	4 67,5	
	22,4	72	0,95	MR ICI 40 - 11 x 140 63 B	4 62,5	
	26	62	1,32	MR ICI 40 - 14 x 160 71 A	6 34,7	
	25,5	63	2,65	MR ICI 50 - 11 x 140 63 B	4 54,9	
	28,8	57	4	MR CI 63 - 14 x 160 71 A	6 31,3	
	29,3	55	1,5	MR ICI 40 - 11 x 140 63 B	4 47,8	
	31,5	51	1,8	MR ICI 40 - 14 x 160 71 A	6 28,6	
	34,4	48	1,4	MR CI 40 - 14 x 160 71 A	6 26,2	
	32,3	50	3,55	MR ICI 50 - 11 x 140 63 B	4 43,3	
	37,4	44,2	3,15	MR CI 50 - 14 x 160 71 A	6 24,1	
	35,5	45,5	2	MR ICI 40 - 11 x 140 63 B	4 39,4	
	40,7	39,7	1,8	MR ICI 40 - 14 x 160 71 A	6 22,1	
	41,5	39,7	1,7	MR CI 40 - 14 x 160 71 A	6 21,7	
		45,9	35,2	2	MR ICI 40 - 11 x 140 63 B	4 30,5
	53,5	30,9	2,24	MR CI 40 - 11 x 140 63 B	4 26,2	
	64,6	25,5	2,65	MR CI 40 - 11 x 140 63 B	4 21,7	
	78,4	21	3,15	MR CI 40 - 11 x 140 63 B	4 17,9	
	102	16,1	5	MR CI 40 - 11 x 140 63 B	4 13,7	
	124	13,3	6,7	MR CI 40 - 11 x 140 63 B	4 11,3	
	161	10,3	6,7	MR CI 40 - 11 x 140 63 B	4 8,72	
0,25	3,56	617	0,9	MR C3I 80 - 14 x 160 71 A	4 393	
	3,56	617	1	MR C3I 81 - 14 x 160 71 A	4 393	
	4,25	516	1,06	MR C3I 80 - 14 x 160 71 A	4 329	
	4,25	516	1,18	MR C3I 81 - 14 x 160 71 A	4 329	
	5,53	397	0,9	MR C3I 64 - 14 x 160 71 A	4 253	
	5,32	413	1,5	MR C3I 80 - 14 x 160 71 A	4 263	
	5,32	413	1,7	MR C3I 81 - 14 x 160 71 A	4 263	
	6,91	318	1,06	MR C3I 63 - 14 x 160 71 A	4 202	
	6,91	318	1,25	MR C3I 64 - 14 x 160 71 A	4 202	
	7,05	312	1,25	MR C3I 63 - 14 x 160 71 B	6 128	
	7,05	312	1,6	MR C3I 64 - 14 x 160 71 B	6 128	
	7,58	296	1	MR ICI 64 - 14 x 160 71 B	6 119	
	6,65	330	2,24	MR C3I 80 - 14 x 160 71 A	4 211	
	6,65	330	2,5	MR C3I 81 - 14 x 160 71 A	4 211	
	7,29	308	1,8	MR ICI 80 - 14 x 160 71 B	6 124	
	7,29	308	2	MR ICI 81 - 14 x 160 71 B	6 124	
	8,64	254	1,25	MR C3I 63 - 14 x 160 71 A	4 162	
	8,64	254	1,4	MR C3I 64 - 14 x 160 71 A	4 162	
	9,47	237	1,12	MR ICI 63 - 14 x 160 71 B	6 95	
	9,47	237	1,4	MR ICI 64 - 14 x 160 71 B	6 95	
8,3	265	2,5	MR C3I 80 - 14 x 160 71 A	4 169		
9,11	246	2,36	MR ICI 80 - 14 x 160 71 B	6 98,8		
9,11	246	2,8	MR ICI 81 - 14 x 160 71 B	6 98,8		
11,3	195	0,9	MR C3I 50 - 14 x 160 71 A	4 124		
11	200	2	MR C3I 63 - 14 x 160 71 A	4 128		
11	200	2,36	MR C3I 64 - 14 x 160 71 A	4 128		
11,8	190	1,25	MR ICI 63 - 14 x 160 71 A	4 119		
11,8	190	1,6	MR ICI 64 - 14 x 160 71 A	4 119		
11,3	198	1,4	MR ICI 63 - 14 x 160 71 B	6 79,5		
11,3	198	1,7	MR ICI 64 - 14 x 160 71 B	6 79,5		
11,3	198	2,8	MR ICI 80 - 14 x 160 71 A	4 124		
11,3	198	3	MR ICI 81 - 14 x 160 71 A	4 124		

1) Powers valid for continuous duty S1; **increase possible** for duty cycles S2 ... S10 (see ch. 1 «General specifications»); in which case M_2 increases and f_s decreases.
 2) For complete designation when ordering see ch. 2.

13 - Selection tables (bevel helical gearmotors)

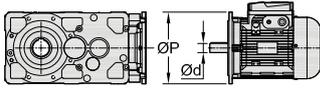

P_1 kW	n_2 min ⁻¹	M_2 N m	f_s		i		
1)				2)			
0,25	14,3	154	1,32	MR C3I 50 - 14 × 160	71 A	4	97,9
	14,7	152	1	MR ICI 50 - 14 × 160	71 B	6	61,1
	14,7	152	1,8	MR ICI 63 - 14 × 160	71 A	4	95
	14,7	152	2,24	MR ICI 64 - 14 × 160	71 A	4	95
	14,2	158	3,75	MR ICI 80 - 14 × 160	71 A	4	98,8
	17,2	128	1,5	MR C3I 50 - 14 × 160	71 A	4	81,5
	16,6	135	1,18	MR ICI 50 - 11 × 140	63 C	4	84,3
	17,6	128	2,12	MR ICI 63 - 14 × 160	71 A	4	79,5
	20,8	108	1,4	MR ICI 50 - 11 × 140	63 C	4	67,5
	22,9	98	1,6	MR ICI 50 - 14 × 160	71 A	4	61,1
	22	102	2,65	MR ICI 63 - 14 × 160	71 A	4	63,6
	25,5	88	0,8	MR ICI 40 - 14 × 160	71 A	4	54,9
	25,5	88	1,9	MR ICI 50 - 11 × 140	63 C	4	54,9
	28,6	78	2	MR ICI 50 - 14 × 160	71 A	4	48,9
	27,5	82	3,55	MR ICI 63 - 14 × 160	71 A	4	50,9
	28,8	80	3	MR CI 63 - 14 × 160	71 B	6	31,3
	29,3	77	1,12	MR ICI 40 - 11 × 140	63 C	4	47,8
	30,9	73	0,9	MR ICI 40 - 14 × 160	71 A	4	45,3
	31,5	71	1,32	MR ICI 40 - 14 × 160	71 B	6	28,6
	34,4	67	1	MR CI 40 - 14 × 160	71 B	6	26,2
	35,2	64	2,65	MR ICI 50 - 14 × 160	71 A	4	39,8
	37,4	61	2,24	MR CI 50 - 14 × 160	71 B	6	24,1
	35,5	63	1,5	MR ICI 40 - 11 × 140	63 C	4	39,4
	40,4	56	1,5	MR ICI 40 - 14 × 160	71 A	4	34,7
	41,5	55	1,25	MR CI 40 - 14 × 160	71 B	6	21,7
	44,6	50	3,55	MR ICI 50 - 14 × 160	71 A	4	31,4
	46,7	49,1	3,15	MR CI 50 - 14 × 160	71 B	6	19,3
	45,9	48,9	1,5	MR ICI 40 - 11 × 140	63 C	4	30,5
	49	45,8	2	MR ICI 40 - 14 × 160	71 A	4	28,6
	53,5	42,9	1,6	MR CI 40 - 11 × 140	63 C	4	26,2
	53,5	42,9	1,6	MR CI 40 - 14 × 160	71 A	4	26,2
	58,1	39,4	3,55	MR CI 50 - 11 × 140	63 C	4	24,1
	58,1	39,4	3,55	MR CI 50 - 14 × 160	71 A	4	24,1
	63,3	35,4	2	MR ICI 40 - 14 × 160	71 A	4	22,1
	64,6	35,5	1,9	MR CI 40 - 11 × 140	63 C	4	21,7
	64,6	35,5	1,9	MR CI 40 - 14 × 160	71 A	4	21,7
	72,6	31,6	4,75	MR CI 50 - 11 × 140	63 C	4	19,3
	72,6	31,6	4,75	MR CI 50 - 14 × 160	71 A	4	19,3
	78,4	29,2	2,24	MR CI 40 - 11 × 140	63 C	4	17,9
	78,4	29,2	2,24	MR CI 40 - 14 × 160	71 A	4	17,9
89,2	25,7	5,6	MR CI 50 - 11 × 140	63 C	4	15,7	
89,2	25,7	5,6	MR CI 50 - 14 × 160	71 A	4	15,7	
102	22,4	3,55	MR CI 40 - 11 × 140	63 C	4	13,7	
102	22,4	3,55	MR CI 40 - 14 × 160	71 A	4	13,7	
124	18,4	4,75	MR CI 40 - 11 × 140	63 C	4	11,3	
124	18,4	4,75	MR CI 40 - 14 × 160	71 A	4	11,3	
136	16,9	8,5	MR CI 50 - 14 × 160	71 A	4	10,3	
161	14,3	4,75	MR CI 40 - 11 × 140	63 C	4	8,72	
161	14,3	4,75	MR CI 40 - 14 × 160	71 A	4	8,72	
202	11,4	4,5	MR CI 40 - 11 × 140	63 C	4	6,94	
202	11,4	4,5	MR CI 40 - 14 × 160	71 A	4	6,94	
0,37	2,95	1101	1,06	MR C3I 100 - 19 × 200	80 A	6	305
	3,69	881	1,5	MR C3I 100 - 19 × 200	80 A	6	244
	4,27	761	1,06	MR C3I 81 - 14 × 160	71 C	6	211
	4,61	705	2,12	MR C3I 100 - 19 × 200	80 A	6	195
	5,32	611	1,06	MR C3I 80 - 14 × 160	71 B	4	263
	5,32	611	1,18	MR C3I 81 - 14 × 160	71 B	4	263
	5,67	574	2,36	MR C3I 100 - 19 × 200	80 A	6	159
	6,47	513	2,65	MR ICI 100 - 19 × 200	80 A	6	139
	7,05	461	1,06	MR C3I 64 - 14 × 160	71 C	6	128
	6,65	489	1,5	MR C3I 80 - 14 × 160	71 B	4	211
	6,65	489	1,7	MR C3I 81 - 14 × 160	71 B	4	211
	7,29	456	1,18	MR ICI 80 - 14 × 160	71 C	6	124
	7,29	456	1,32	MR ICI 81 - 14 × 160	71 C	6	124
	7,86	422	2,65	MR ICI 100 - 19 × 200	80 A	6	114

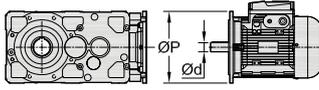
P_1 kW	n_2 min ⁻¹	M_2 N m	f_s		i		
1)				2)			
0,37	8,64	376	0,85	MR C3I 63 - 14 × 160	71 B	4	162
	8,64	376	0,95	MR C3I 64 - 14 × 160	71 B	4	162
	8,83	368	1,32	MR C3I 64 - 19 × 200	80 A	6	102
	9,47	351	0,8	MR ICI 63 - 14 × 160	71 C	6	95
	9,47	351	0,95	MR ICI 64 - 14 × 160	71 C	6	95
	8,3	392	1,7	MR C3I 80 - 14 × 160	71 B	4	169
	8,3	392	1,9	MR C3I 81 - 14 × 160	71 B	4	169
	9,11	365	1,6	MR ICI 80 - 14 × 160	71 C	6	98,8
	9,11	365	1,9	MR ICI 81 - 14 × 160	71 C	6	98,8
	9,83	338	3,75	MR ICI 100 - 19 × 200	80 A	6	91,5
	11	297	1,32	MR C3I 63 - 14 × 160	71 B	4	128
	11	297	1,6	MR C3I 64 - 14 × 160	71 B	4	128
	11,8	282	0,85	MR ICI 63 - 14 × 160	71 B	4	119
	11,8	282	1,06	MR ICI 64 - 14 × 160	71 B	4	119
	11,3	294	0,95	MR ICI 63 - 14 × 160	71 C	6	79,5
	11,3	294	1,12	MR ICI 64 - 14 × 160	71 C	6	79,5
	10,5	309	2,65	MR C3I 80 - 14 × 160	71 B	4	133
	11,3	293	1,8	MR ICI 80 - 14 × 160	71 B	4	124
	11,3	293	2,12	MR ICI 81 - 14 × 160	71 B	4	124
	10,9	305	1,9	MR ICI 80 - 14 × 160	71 C	6	82,7
	10,9	305	2,24	MR ICI 81 - 14 × 160	71 C	6	82,7
	14,7	225	1,18	MR ICI 63 - 14 × 160	71 B	4	95
	14,7	225	1,5	MR ICI 64 - 14 × 160	71 B	4	95
	14,2	234	2,5	MR ICI 80 - 14 × 160	71 B	4	98,8
	14,2	234	2,8	MR ICI 81 - 14 × 160	71 B	4	98,8
	18,4	180	0,85	MR ICI 50 - 14 × 160	71 C	6	48,9
	18,4	181	0,85	MR ICI 50 - 19 × 200	80 A	6	48,9
	17,6	189	1,4	MR ICI 63 - 14 × 160	71 B	4	79,5
	17,6	189	1,8	MR ICI 64 - 14 × 160	71 B	4	79,5
	16,9	196	3	MR ICI 80 - 14 × 160	71 B	4	82,7
	20,8	160	0,95	MR ICI 50 - 11 × 140	71 B *	4	67,5
	22,9	145	1,06	MR ICI 50 - 14 × 160	71 B	4	61,1
	22	151	1,8	MR ICI 63 - 14 × 160	71 B	4	63,6
	22	151	2,24	MR ICI 64 - 14 × 160	71 B	4	63,6
	28,6	116	1,32	MR ICI 50 - 14 × 160	71 B	4	48,9
	27,5	121	2,5	MR ICI 63 - 14 × 160	71 B	4	50,9
	28,8	118	2	MR CI 63 - 14 × 160	71 C	6	31,3
	28,8	118	2,24	MR CI 64 - 14 × 160	71 C	6	31,3
	28,8	118	2	MR CI 63 - 19 × 200	80 A	6	31,3
	28,8	118	2,24	MR CI 64 - 19 × 200	80 A	6	31,3
	35,2	94	1,7	MR ICI 50 - 14 × 160	71 B	4	39,8
	37,4	91	1,5	MR CI 50 - 14 × 160	71 C	6	24,1
	37,4	91	1,5	MR CI 50 - 19 × 200	80 A	6	24,1
	36	94	2,8	MR CI 63 - 14 × 160	71 C	6	25
	36	94	2,8	MR CI 63 - 19 × 200	80 A	6	25
	35,5	94	1	MR ICI 40 - 11 × 140	71 B *	4	39,4
	40,4	82	1	MR ICI 40 - 14 × 160	71 B	4	34,7
	41,5	82	0,85	MR CI 40 - 14 × 160	71 C	6	21,7
	44,6	74	2,36	MR ICI 50 - 14 × 160	71 B	4	31,4
	46,7	73	2,12	MR CI 50 - 14 × 160	71 C	6	19,3
46,7	73	2,12	MR CI 50 - 19 × 200	80 A	6	19,3	
44,8	76	3	MR CI 63 - 14 × 160	71 B	4	31,3	
45,9	72	1	MR ICI 40 - 11 × 140	71 B *	4	30,5	
49	68	1,32	MR ICI 40 - 14 × 160	71 B	4	28,6	
53,5	63	1,06	MR CI 40 - 14 × 160	71 B	4	26,2	
58,1	58	2,36	MR CI 50 - 14 × 160	71 B	4	24,1	
63,3	52	1,32	MR ICI 40 - 14 × 160	71 B	4	22,1	
64,6	52	1,32	MR CI 40 - 14 × 160	71 B	4	21,7	
72,6	46,7	3,15	MR CI 50 - 14 × 160	71 B	4	19,3	
78,4	43,3	1,5	MR CI 40 - 14 × 160	71 B	4	17,9	
89,2	38	3,75	MR CI 50 - 14 × 160	71 B	4	15,7	
102	33,1	2,5	MR CI 40 - 14 × 160	71 B	4	13,7	
124	27,3	3,15	MR CI 40 - 14 × 160	71 B	4	11,3	
136	25	6	MR CI 50 - 14 × 160	71 B	4	10,3	
161	21,1	3,15	MR CI 40 - 14 × 160	71 B	4	8,72	
202	16,8	3	MR CI 40 - 14 × 160	71 B	4	6,94	

13

1) Powers valid for continuous duty S1; **increase possible** for duty cycles S2 ... S10 (see ch. 1 «General specifications»); in which case M_2 increases and f_s decreases.

2) For complete designation when ordering see ch. 2.

* Mounting position **B5R** (see ch. 1.2).

13 - Selection tables (bevel helical gearmotors)

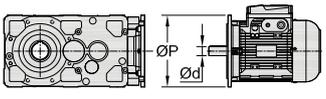

P_1 kW	n_2 min ⁻¹	M_2 N m	f_s		i
1)				2)	
0,55	3,69	1310	1	MR C3I 100 - 19 × 200 80 B	6 244
	4,59	1052	1,06	MR C3I 100 - 19 × 200 80 A	4 305
	4,61	1048	1,4	MR C3I 100 - 19 × 200 80 B	6 195
	5,74	842	1,5	MR C3I 100 - 19 × 200 80 A	4 244
	6,47	763	1,8	MR ICI 100 - 19 × 200 80 B	6 139
	6,65	727	1	MR C3I 80 - 14 × 160 71 C	4 211
	6,65	727	1,12	MR C3I 81 - 14 × 160 71 C	4 211
	6,67	725	0,85	MR C3I 80 - 19 × 200 80 A	4 210
	6,67	725	1	MR C3I 81 - 19 × 200 80 A	4 210
	7,18	673	2,24	MR C3I 100 - 19 × 200 80 A	4 195
	7,86	628	1,8	MR ICI 100 - 19 × 200 80 B	6 114
	8,3	582	1,12	MR C3I 80 - 14 × 160 71 C	4 169
	8,3	582	1,25	MR C3I 81 - 14 × 160 71 C	4 169
	8,33	580	1,25	MR C3I 80 - 19 × 200 80 A	4 168
	8,33	580	1,4	MR C3I 81 - 19 × 200 80 A	4 168
	8,81	548	2,5	MR C3I 100 - 19 × 200 80 A	4 159
	10,1	491	2,65	MR ICI 100 - 19 × 200 80 A	4 139
	11	441	1,12	MR C3I 64 - 14 × 160 71 C	4 128
	10,5	459	1,8	MR C3I 80 - 14 × 160 71 C	4 133
	10,5	459	2,12	MR C3I 81 - 14 × 160 71 C	4 133
	10,4	465	1,4	MR C3I 80 - 19 × 200 80 A	4 135
	10,4	465	1,6	MR C3I 81 - 19 × 200 80 A	4 135
	11,3	436	1,25	MR ICI 80 - 14 × 160 71 C	4 124
	11,3	436	1,4	MR ICI 81 - 14 × 160 71 C	4 124
	10,9	453	1,18	MR ICI 80 - 19 × 200 80 B	6 82,5
	10,9	453	1,32	MR ICI 81 - 19 × 200 80 B	6 82,5
	12,2	404	2,65	MR ICI 100 - 19 × 200 80 A	4 114
	13,7	352	1,12	MR C3I 63 - 19 × 200 80 A	4 102
	13,7	352	1,4	MR C3I 64 - 19 × 200 80 A	4 102
	14,7	335	0,8	MR ICI 63 - 14 × 160 71 C	4 95
	14,7	335	1	MR ICI 64 - 14 × 160 71 C	4 95
	14,2	348	0,8	MR ICI 63 - 19 × 200 80 B	6 63,5
	14,2	348	0,95	MR ICI 64 - 19 × 200 80 B	6 63,5
	13,2	366	2,24	MR C3I 80 - 19 × 200 80 A	4 106
	13,2	366	2,65	MR C3I 81 - 19 × 200 80 A	4 106
	14,2	348	1,7	MR ICI 80 - 14 × 160 71 C	4 98,8
	14,2	348	1,9	MR ICI 81 - 14 × 160 71 C	4 98,8
	13,6	362	1,6	MR ICI 80 - 19 × 200 80 B	6 66
	13,6	362	1,9	MR ICI 81 - 19 × 200 80 B	6 66
	15,3	323	4	MR ICI 100 - 19 × 200 80 A	4 91,5
	17,6	281	0,95	MR ICI 63 - 14 × 160 71 C	4 79,5
	17,6	281	1,18	MR ICI 64 - 14 × 160 71 C	4 79,5
	17,6	280	0,9	MR ICI 63 - 19 × 200 80 A	4 79,3
	17,6	280	1,06	MR ICI 64 - 19 × 200 80 A	4 79,3
	17,7	279	1	MR ICI 63 - 19 × 200 80 B	6 50,8
	17,7	279	1,18	MR ICI 64 - 19 × 200 80 B	6 50,8
	16,9	292	2	MR ICI 80 - 14 × 160 71 C	4 82,7
	16,9	292	2,24	MR ICI 81 - 14 × 160 71 C	4 82,7
	17	291	1,8	MR ICI 80 - 19 × 200 80 A	4 82,5
	17	291	2	MR ICI 81 - 19 × 200 80 A	4 82,5
	17	290	2	MR ICI 80 - 19 × 200 80 B	6 52,8
	17	290	2,36	MR ICI 81 - 19 × 200 80 B	6 52,8
	18,3	270	4,5	MR ICI 100 - 19 × 200 80 A	4 76,7
	22	224	1,18	MR ICI 63 - 14 × 160 71 C	4 63,6
	22	224	1,5	MR ICI 64 - 14 × 160 71 C	4 63,6
	22,1	224	1,18	MR ICI 63 - 19 × 200 80 A	4 63,5
	22,1	224	1,5	MR ICI 64 - 19 × 200 80 A	4 63,5
	21,2	233	2,5	MR ICI 80 - 19 × 200 80 A	4 66
	28,6	172	0,9	MR ICI 50 - 14 × 160 71 C	4 48,9
	28,6	172	0,9	MR ICI 50 - 19 × 200 80 A	4 48,9
	27,5	180	1,6	MR ICI 63 - 14 × 160 71 C	4 50,9
	27,5	180	1,9	MR ICI 64 - 14 × 160 71 C	4 50,9
	27,6	179	1,5	MR ICI 63 - 19 × 200 80 A	4 50,8
	27,6	179	1,9	MR ICI 64 - 19 × 200 80 A	4 50,8
	28,8	175	1,32	MR CI 63 - 19 × 200 80 B	6 31,3
	28,8	175	1,5	MR CI 64 - 19 × 200 80 B	6 31,3
	26,5	186	3,15	MR ICI 80 - 19 × 200 80 A	4 52,8
	27,7	182	2,65	MR CI 80 - 19 × 200 80 B	6 32,5

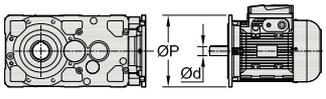
P_1 kW	n_2 min ⁻¹	M_2 N m	f_s		i
1)				2)	
0,55	35,2	140	1,18	MR ICI 50 - 14 × 160 71 C	4 39,8
	35,8	138	1,12	MR ICI 50 - 19 × 200 80 A	4 39,1
	37,4	135	1,06	MR CI 50 - 19 × 200 80 B	6 24,1
	34,5	143	2	MR ICI 63 - 19 × 200 80 A	4 40,6
	36	140	1,9	MR CI 63 - 19 × 200 80 B	6 25
	36	140	2,36	MR CI 64 - 19 × 200 80 B	6 25
	44,6	111	1,6	MR ICI 50 - 14 × 160 71 C	4 31,4
	43,9	112	1,5	MR ICI 50 - 19 × 200 80 A	4 31,9
	46,7	108	1,4	MR CI 50 - 19 × 200 80 B	6 19,3
	43,7	113	2,8	MR ICI 63 - 19 × 200 80 A	4 32
	44,8	113	2	MR CI 63 - 14 × 160 71 C	4 31,3
	44,8	113	2,24	MR CI 64 - 14 × 160 71 C	4 31,3
	44,8	113	2	MR CI 63 - 19 × 200 80 A	4 31,3
	44,8	113	2,24	MR CI 64 - 19 × 200 80 A	4 31,3
	45	112	2,36	MR CI 63 - 19 × 200 80 B	6 20
	55,7	89	2	MR ICI 50 - 19 × 200 80 A	4 25,1
	58,1	87	1,6	MR CI 50 - 14 × 160 71 C	4 24,1
	58,1	87	1,6	MR CI 50 - 19 × 200 80 A	4 24,1
	56	90	3	MR CI 63 - 14 × 160 71 C	4 25
	56	90	3	MR CI 63 - 19 × 200 80 A	4 25
	63,3	78	0,9	MR ICI 40 - 14 × 160 71 C	4 22,1
	64,6	78	0,85	MR CI 40 - 14 × 160 71 C	4 21,7
	66,9	74	2,5	MR ICI 50 - 19 × 200 80 A	4 20,9
	72,6	69	2,12	MR CI 50 - 14 × 160 71 C	4 19,3
	72,6	69	2,12	MR CI 50 - 19 × 200 80 A	4 19,3
	78,4	64	1	MR CI 40 - 14 × 160 71 C	4 17,9
	89,2	57	2,5	MR CI 50 - 14 × 160 71 C	4 15,7
	89,2	57	2,5	MR CI 50 - 19 × 200 80 A	4 15,7
	102	49,2	1,6	MR CI 40 - 14 × 160 71 C	4 13,7
	113	44,6	3,55	MR CI 50 - 14 × 160 71 C	4 12,4
	113	44,6	3,55	MR CI 50 - 19 × 200 80 A	4 12,4
	124	40,6	2,12	MR CI 40 - 14 × 160 71 C	4 11,3
	136	37,1	4	MR CI 50 - 14 × 160 71 C	4 10,3
	136	37,1	4	MR CI 50 - 19 × 200 80 A	4 10,3
	161	31,4	2,12	MR CI 40 - 14 × 160 71 C	4 8,72
	174	29	4,25	MR CI 50 - 14 × 160 71 C	4 8,06
	174	29	4,25	MR CI 50 - 19 × 200 80 A	4 8,06
	202	25	2	MR CI 40 - 14 × 160 71 C	4 6,94
	217	23,3	3,75	MR CI 50 - 14 × 160 71 C	4 6,46
	217	23,3	3,75	MR CI 50 - 19 × 200 80 A	4 6,46
0,75	2,39	2758	0,9	MR C3I 125 - 24 × 200 90 S	6 377
	2,95	2234	1,12	MR C3I 125 - 24 × 200 90 S	6 305
	3,69	1788	1,5	MR C3I 125 - 24 × 200 90 S	6 244
	4,61	1429	1,06	MR C3I 100 - 19 × 200 80 C	6 195
	4,63	1425	0,9	MR C3I 100 - 24 × 200 90 S	6 195
	4,61	1430	2,12	MR C3I 125 - 24 × 200 90 S	6 195
	5,74	1148	1,12	MR C3I 100 - 19 × 200 80 B	4 244
	6,47	1041	1,32	MR ICI 100 - 19 × 200 80 C	6 139
	5,76	1144	2,65	MR C3I 125 - 24 × 200 90 S	6 156
	7,18	918	1,6	MR C3I 100 - 19 × 200 80 B	4 195
	7,86	856	1,32	MR ICI 100 - 19 × 200 80 C	6 114
	7,47	902	2,65	MR ICI 125 - 24 × 200 90 S	6 121
	8,33	791	1	MR C3I 81 - 19 × 200 80 B	4 168
	8,48	777	1,06	MR C3I 80 - 19 × 200 80 C	6 106
	8,48	777	1,25	MR C3I 81 - 19 × 200 80 C	6 106
	8,81	748	1,8	MR C3I 100 - 19 × 200 80 B	4 159
	10,1	669	2	MR ICI 100 - 19 × 200 80 B	4 139
	9,33	721	3,55	MR ICI 125 - 24 × 200 90 S	6 96,4
	10,4	634	1	MR C3I 80 - 19 × 200 80 B	4 135
	10,4	634	1,12	MR C3I 81 - 19 × 200 80 B	4 135
	11,3	594	0,9	MR ICI 80 - 14 × 160 80 B	* 4 124
	11,3	594	1	MR ICI 81 - 14 × 160 80 B	* 4 124
	10,9	617	0,9	MR ICI 80 - 19 × 200 80 C	6 82,5
	10,9	617	1	MR ICI 81 - 19 × 200 80 C	6 82,5
	11,2	590	3	MR C3I 100 - 19 × 200 80 B	4 125
	12,2	550	2	MR ICI 100 - 19 × 200 80 B	4 114
	11,7	573	2,24	MR ICI 100 - 19 × 200 80 C	6 76,7
	11,5	584	4,5	MR ICI 125 - 24 × 200 90 S	6 78,1

1) Powers valid for continuous duty S1; **increase possible** for duty cycles S2 ... S10 (see ch. 1 «General specifications»); in which case M_2 increases and f_s decreases.

2) For complete designation when ordering see ch. 2.

* Mounting position **B5R** (see ch. 1.2).

13 - Selection tables (bevel helical gearmotors)

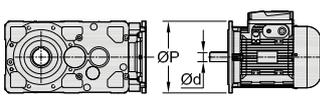

P_1 kW	n_2 min ⁻¹	M_2 N m	f_s		i
1)				2)	
0,75	13,2	500	1,7	MR C3I 80 - 19 × 200 80 B 4	106
	14,2	500	1,9	MR C3I 81 - 19 × 200 80 B 4	106
	14,2	475	1,25	MR ICI 80 - 14 × 160 80 B * 4	98,8
	14,2	475	1,4	MR ICI 81 - 14 × 160 80 B * 4	98,8
	13,6	494	1,18	MR ICI 80 - 19 × 200 80 C 6	66
	13,6	494	1,32	MR ICI 81 - 19 × 200 80 C 6	66
	13,8	486	1,12	MR ICI 80 - 24 × 200 90 S 6	65
	13,8	486	1,25	MR ICI 81 - 24 × 200 90 S 6	65
	15,3	440	2,8	MR ICI 100 - 19 × 200 80 B 4	91,5
	17,6	383	0,9	MR ICI 64 - 14 × 160 80 B * 4	79,5
17,7	380	0,9	MR ICI 64 - 19 × 200 80 C 6	50,8	
18	374	0,9	MR ICI 64 - 24 × 200 90 S 6	50	
16,9	398	1,5	MR ICI 80 - 14 × 160 80 B * 4	82,7	
16,9	398	1,7	MR ICI 81 - 14 × 160 80 B * 4	82,7	
17	397	1,32	MR ICI 80 - 19 × 200 80 B 4	82,5	
17	397	1,5	MR ICI 81 - 19 × 200 80 B 4	82,5	
17	395	1,5	MR ICI 80 - 19 × 200 80 C 6	52,8	
17	395	1,7	MR ICI 81 - 19 × 200 80 C 6	52,8	
17,3	389	1,5	MR ICI 80 - 24 × 200 90 S 6	52	
17,3	389	1,7	MR ICI 81 - 24 × 200 90 S 6	52	
18,3	369	3,35	MR ICI 100 - 19 × 200 80 B 4	76,7	
22,1	305	0,9	MR ICI 63 - 19 × 200 80 B 4	63,5	
22,1	305	1,06	MR ICI 64 - 19 × 200 80 B 4	63,5	
21,2	317	1,8	MR ICI 80 - 19 × 200 80 B 4	66	
21,2	317	2,12	MR ICI 81 - 19 × 200 80 B 4	66	
27,6	244	1,12	MR ICI 63 - 19 × 200 80 B 4	50,8	
27,6	244	1,4	MR ICI 64 - 19 × 200 80 B 4	50,8	
28,1	240	1,32	MR ICI 63 - 19 × 200 80 C 6	32	
28,1	240	1,6	MR ICI 64 - 19 × 200 80 C 6	32	
28,8	239	1	MR CI 63 - 19 × 200 80 C 6	31,3	
28,8	239	1,06	MR CI 64 - 19 × 200 80 C 6	31,3	
28,8	239	1	MR CI 63 - 24 × 200 90 S 6	31,3	
28,8	239	1,06	MR CI 64 - 24 × 200 90 S 6	31,3	
26,5	254	2,24	MR ICI 80 - 19 × 200 80 B 4	52,8	
27,7	248	1,9	MR CI 80 - 19 × 200 80 C 6	32,5	
27,7	248	1,9	MR CI 80 - 24 × 200 90 S 6	32,5	
35,2	191	0,85	MR ICI 50 - 14 × 160 80 B * 4	39,8	
35,8	188	0,95	MR ICI 50 - 19 × 200 80 C 6	25,1	
34,5	195	1,5	MR ICI 63 - 19 × 200 80 B 4	40,6	
34,5	195	1,8	MR ICI 64 - 19 × 200 80 B 4	40,6	
36	191	1,4	MR CI 63 - 19 × 200 80 C 6	25	
36	191	1,7	MR CI 64 - 19 × 200 80 C 6	25	
36	191	1,4	MR CI 63 - 24 × 200 90 S 6	25	
36	191	1,7	MR CI 64 - 24 × 200 90 S 6	25	
33,1	203	3	MR ICI 80 - 19 × 200 80 B 4	42,3	
34,6	199	3	MR CI 80 - 19 × 200 80 C 6	26	
34,6	199	3	MR CI 80 - 24 × 200 90 S 6	26	
43,9	153	1,06	MR ICI 50 - 19 × 200 80 B 4	31,9	
46,7	147	1	MR CI 50 - 19 × 200 80 C 6	19,3	
43,7	154	2	MR ICI 63 - 19 × 200 80 B 4	32	
43,7	154	2,5	MR ICI 64 - 19 × 200 80 B 4	32	
44,8	153	1,5	MR CI 63 - 19 × 200 80 B 4	31,3	
44,8	153	1,7	MR CI 64 - 19 × 200 80 B 4	31,3	
45	153	1,8	MR CI 63 - 19 × 200 80 C 6	20	
45	153	2,12	MR CI 64 - 19 × 200 80 C 6	20	
45	153	1,8	MR CI 63 - 24 × 200 90 S 6	20	
45	153	2,12	MR CI 64 - 24 × 200 90 S 6	20	
43,1	160	3	MR CI 80 - 19 × 200 80 B 4	32,5	
55,7	121	1,5	MR ICI 50 - 19 × 200 80 B 4	25,1	
58,1	118	1,18	MR CI 50 - 19 × 200 80 B 4	24,1	
56	123	2,24	MR CI 63 - 19 × 200 80 B 4	25	
66,9	101	1,8	MR ICI 50 - 19 × 200 80 B 4	20,9	
72,6	95	1,6	MR CI 50 - 19 × 200 80 B 4	19,3	
70	98	2,65	MR CI 63 - 19 × 200 80 B 4	20	
89,2	77	1,9	MR CI 50 - 19 × 200 80 B 4	15,7	
87,5	79	3,35	MR CI 63 - 19 × 200 80 B 4	16	
102	67	1,18	MR CI 40 - 14 × 160 71 D 4	13,7	
113	61	2,65	MR CI 50 - 19 × 200 80 B 4	12,4	
124	55	1,6	MR CI 40 - 14 × 160 71 D 4	11,3	
136	51	3	MR CI 50 - 19 × 200 80 B 4	10,3	
161	42,8	1,6	MR CI 40 - 14 × 160 71 D 4	8,72	
174	39,6	3,15	MR CI 50 - 19 × 200 80 B 4	8,06	

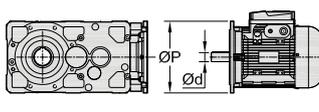
P_1 kW	n_2 min ⁻¹	M_2 N m	f_s		i
1)				2)	
0,75	202	34,1	1,5	MR CI 40 - 14 × 160 71 D 4	6,94
	217	31,7	2,65	MR CI 50 - 19 × 200 80 B 4	6,46
1,1	3,72	2600	0,95	MR C3I 125 - 24 × 200 90 S 4	377
	4,59	2107	1,18	MR C3I 125 - 24 × 200 90 S 4	305
	5,73	1685	1,6	MR C3I 125 - 24 × 200 90 S 4	244
	7,18	1347	1,12	MR C3I 100 - 19 × 200 80 C 4	195
	7,19	1343	0,95	MR C3I 100 - 24 × 200 90 S 4	195
	7,17	1348	2,24	MR C3I 125 - 24 × 200 90 S 4	195
	7,47	1323	1,8	MR ICI 125 - 24 × 200 90 L 6	121
	8,81	1097	1,25	MR C3I 100 - 19 × 200 80 C 4	159
	8,99	1075	1,4	MR C3I 100 - 24 × 200 90 S 4	156
	10,1	981	1,32	MR ICI 100 - 19 × 200 80 C 4	139
	8,96	1079	2,8	MR C3I 125 - 24 × 200 90 S 4	156
	9,33	1058	2,5	MR ICI 125 - 24 × 200 90 L 6	96,4
	11,2	865	2	MR C3I 100 - 19 × 200 80 C 4	125
	11	875	1,5	MR C3I 100 - 24 × 200 90 S 4	127
	12,2	807	1,32	MR ICI 100 - 19 × 200 80 C 4	114
	11,8	839	1,32	MR ICI 100 - 24 × 200 90 L 6	76,4
	11,6	850	2,8	MR ICI 125 - 24 × 200 90 S 4	121
	13,2	733	1,12	MR C3I 80 - 19 × 200 80 C 4	106
	13,2	733	1,32	MR C3I 81 - 19 × 200 80 C 4	106
	14	690	2,5	MR C3I 100 - 24 × 200 90 S 4	99,9
	15,3	646	1,9	MR ICI 100 - 19 × 200 80 C 4	91,5
	15,1	655	1,9	MR ICI 100 - 24 × 200 90 S 4	92,9
	14,7	671	1,9	MR ICI 100 - 24 × 200 90 L 6	61,2
	14,5	680	3,75	MR ICI 125 - 24 × 200 90 S 4	96,4
	17	582	0,9	MR ICI 80 - 19 × 200 80 C 4	82,5
	17	582	1	MR ICI 81 - 19 × 200 80 C 4	82,5
	17,3	571	1	MR ICI 80 - 24 × 200 90 L 6	52
	17,3	571	1,18	MR ICI 81 - 24 × 200 90 L 6	52
	18,3	541	2,36	MR ICI 100 - 19 × 200 80 C 4	76,7
	18,3	539	2	MR ICI 100 - 24 × 200 90 S 4	76,4
18,4	537	2,65	MR ICI 100 - 24 × 200 90 L 6	48,9	
21,2	466	1,25	MR ICI 80 - 19 × 200 80 C 4	66	
21,2	466	1,4	MR ICI 81 - 19 × 200 80 C 4	66	
21,5	458	1,18	MR ICI 80 - 24 × 200 90 S 4	65	
21,5	458	1,32	MR ICI 81 - 24 × 200 90 S 4	65	
21,6	456	1,25	MR ICI 80 - 24 × 200 90 L 6	41,6	
21,6	456	1,5	MR ICI 81 - 24 × 200 90 L 6	41,6	
22,8	433	3,15	MR ICI 100 - 19 × 200 80 C 4	61,3	
22,9	431	2,8	MR ICI 100 - 24 × 200 90 S 4	61,2	
24,6	410	2,8	MR CI 100 - 24 × 200 90 L 6	36,6	
27,6	358	0,95	MR ICI 64 - 19 × 200 80 C 4	50,8	
28	353	0,95	MR ICI 64 - 24 × 200 90 S 4	50	
28,1	351	0,85	MR ICI 63 - 24 × 200 90 L 6	32	
26,5	372	1,6	MR ICI 80 - 19 × 200 80 C 4	52,8	
26,5	372	1,8	MR ICI 81 - 19 × 200 80 C 4	52,8	
26,9	367	1,6	MR ICI 80 - 24 × 200 90 S 4	52	
26,9	367	1,8	MR ICI 81 - 24 × 200 90 S 4	52	
27,7	364	1,32	MR CI 80 - 24 × 200 90 L 6	32,5	
27,7	364	1,6	MR CI 81 - 24 × 200 90 L 6	32,5	
28	352	3,75	MR ICI 100 - 19 × 200 80 C 4	49,9	
28,6	345	4	MR ICI 100 - 24 × 200 90 S 4	48,9	
29,9	337	3,15	MR CI 100 - 24 × 200 90 L 6	30,1	
34,5	286	1	MR ICI 63 - 19 × 200 80 C 4	40,6	
34,5	286	1,18	MR ICI 64 - 19 × 200 80 C 4	40,6	
35	282	0,95	MR ICI 63 - 24 × 200 90 S 4	40	
35	282	1,18	MR ICI 64 - 24 × 200 90 S 4	40	
35,7	277	1,12	MR ICI 63 - 24 × 200 90 L 6	25,2	
35,7	277	1,4	MR ICI 64 - 24 × 200 90 L 6	25,2	
36	280	0,95	MR CI 63 - 24 × 200 90 L 6	25	
36	280	1,18	MR CI 64 - 24 × 200 90 L 6	25	
33,1	298	2,12	MR ICI 80 - 19 × 200 80 C 4	42,3	
33,1	298	2,36	MR ICI 81 - 19 × 200 80 C 4	42,3	
33,7	293	2	MR ICI 80 - 24 × 200 90 S 4	41,6	
33,7	293	2,24	MR ICI 81 - 24 × 200 90 S 4	41,6	
34,6	291	2	MR CI 80 - 24 × 200 90 L 6	26	
34,6	291	2,24	MR CI 81 - 24 × 200 90 L 6	26	

1) Powers valid for continuous duty S1; **increase possible** for duty cycles S2 ... S10 (see ch. 1 «General specifications»); in which case M_2 increases and f_s decreases.
 2) For complete designation when ordering see ch. 2.
 * Mounting position **B5R** (see ch. 1.2).

13 - Selection tables (bevel helical gearmotors)

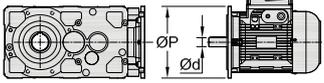

P_1 kW	n_2 min ⁻¹	M_2 N m	f_s		i	
1)				2)		
1,1	43,7	226	1,4	MR ICI 63 - 19 × 200 80 C	4 32	
	43,7	226	1,7	MR ICI 64 - 19 × 200 80 C	4 32	
	43,8	226	1,32	MR ICI 63 - 24 × 200 90 S	4 32	
	43,8	226	1,5	MR ICI 64 - 24 × 200 90 S	4 32	
	44,8	225	1	MR CI 63 - 19 × 200 80 C	4 31,3	
	44,8	225	1,12	MR CI 64 - 19 × 200 80 C	4 31,3	
	44,8	225	1	MR CI 63 - 24 × 200 90 S	4 31,3	
	44,8	225	1,12	MR CI 64 - 24 × 200 90 S	4 31,3	
	45	224	1,18	MR CI 63 - 24 × 200 90 L	6 20	
	45	224	1,5	MR CI 64 - 24 × 200 90 L	6 20	
	42	235	2,8	MR ICI 80 - 19 × 200 80 C	4 33,4	
	42	235	2,65	MR ICI 80 - 24 × 200 90 S	4 33,3	
	43,1	234	2	MR CI 80 - 19 × 200 80 C	4 32,5	
	43,1	234	2,5	MR CI 81 - 19 × 200 80 C	4 32,5	
	43,1	234	2	MR CI 80 - 24 × 200 90 S	4 32,5	
	43,1	234	2,5	MR CI 81 - 24 × 200 90 S	4 32,5	
	43,3	233	2,5	MR CI 80 - 24 × 200 90 L	6 20,8	
	46,5	217	4,75	MR CI 100 - 24 × 200 90 S	4 30,1	
	55,7	177	1	MR ICI 50 - 19 × 200 80 C	4 25,1	
	58,1	174	0,8	MR CI 50 - 19 × 200 80 C	4 24,1	
	55,5	178	1,8	MR ICI 63 - 24 × 200 90 S	4 25,2	
	55,5	178	2,12	MR ICI 64 - 24 × 200 90 S	4 25,2	
	56	180	1,5	MR CI 63 - 19 × 200 80 C	4 25	
	56	180	1,8	MR CI 64 - 19 × 200 80 C	4 25	
	56	180	1,5	MR CI 63 - 24 × 200 90 S	4 25	
	56	180	1,8	MR CI 64 - 24 × 200 90 S	4 25	
	53,8	187	3	MR CI 80 - 19 × 200 80 C	4 26	
	53,8	187	3	MR CI 80 - 24 × 200 90 S	4 26	
	66,9	148	1,25	MR ICI 50 - 19 × 200 80 C	4 20,9	
	72,6	139	1,06	MR CI 50 - 19 × 200 80 C	4 19,3	
	67,6	146	2,24	MR ICI 63 - 24 × 200 90 S	4 20,7	
	67,6	146	2,5	MR ICI 64 - 24 × 200 90 S	4 20,7	
	70	144	1,9	MR CI 63 - 19 × 200 80 C	4 20	
	70	144	2,24	MR CI 64 - 19 × 200 80 C	4 20	
	70	144	1,9	MR CI 63 - 24 × 200 90 S	4 20	
	70	144	2,24	MR CI 64 - 24 × 200 90 S	4 20	
	89,2	113	1,25	MR CI 50 - 19 × 200 80 C	4 15,7	
	87,5	115	2,36	MR CI 63 - 19 × 200 80 C	4 16	
	87,5	115	2,36	MR CI 63 - 24 × 200 90 S	4 16	
	113	89	1,8	MR CI 50 - 19 × 200 80 C	4 12,4	
	111	91	3,35	MR CI 63 - 19 × 200 80 C	4 12,6	
	111	91	3,35	MR CI 63 - 24 × 200 90 S	4 12,6	
	136	74	2	MR CI 50 - 19 × 200 80 C	4 10,3	
	135	75	3,75	MR CI 63 - 19 × 200 80 C	4 10,4	
	135	75	3,75	MR CI 63 - 24 × 200 90 S	4 10,4	
174	58	2,12	MR CI 50 - 19 × 200 80 C	4 8,06		
175	57	3,75	MR CI 63 - 19 × 200 80 C	4 7,98		
175	57	3,75	MR CI 63 - 24 × 200 90 S	4 7,98		
217	46,5	1,8	MR CI 50 - 19 × 200 80 C	4 6,46		
222	45,4	3,75	MR CI 63 - 19 × 200 80 C	4 6,31		
222	45,4	3,75	MR CI 63 - 24 × 200 90 S	4 6,31		
1,5	4,61	2860	1,06	MR C3I 125 - 24 × 200 90 LC	6 195	
	4,54	2901	0,9	MR C3I 125 - 28 × 250 100 LA	6 198	
	5,73	2298	1,18	MR C3I 125 - 24 × 200 90 L	4 244	
	5,98	2253	1,9	MR C2I 140 - 28 × 250 100 LA	6 151	
	5,85	2302	2,8	MR C2I 160 - 28 × 250 100 LA	6 154	
	7,17	1839	1,7	MR C3I 125 - 24 × 200 90 L	4 195	
	7,47	1803	1,32	MR ICI 125 - 24 × 200 90 LC	6 121	
	7,33	1837	2,36	MR C2I 140 - 28 × 250 100 LA	6 123	
	7,31	1841	2,5	MR ICI 160 - 28 × 250 100 LA	6 123	
	8,99	1465	1	MR C3I 100 - 24 × 200 90 L	4 156	
	10,1	1338	1	MR ICI 100 - 19 × 200 90 L *	4 139	
	9,69	1390	0,95	MR ICI 100 - 24 × 200 90 LC	6 92,9	
	8,96	1471	2	MR C3I 125 - 24 × 200 90 L	4 156	
	9,33	1443	1,8	MR ICI 125 - 24 × 200 90 LC	6 96,4	
	9,22	1461	1,6	MR ICI 125 - 28 × 250 100 LA	6 97,7	
	9,33	1443	2,12	MR ICI 140 - 24 × 200 90 LC	6 96,4	
	9,16	1469	3	MR C2I 140 - 28 × 250 100 LA	6 98,2	
	1,5	10,3	1313	3,35	MR C2I 140 - 28 × 250 100 LA	6 87,8
		11	1193	1,12	MR C3I 100 - 24 × 200 90 L	4 127
		12,2	1101	1	MR ICI 100 - 19 × 200 90 L *	4 114
		11,8	1144	0,95	MR ICI 100 - 24 × 200 90 LC	6 76,4
		12,3	1095	1,18	MR ICI 100 - 28 × 250 100 LA	6 73,2
		11,4	1160	3	MR C3I 125 - 24 × 200 90 L	4 123
		11,6	1159	2	MR ICI 125 - 24 × 200 90 L	4 121
		11,5	1169	2,65	MR ICI 140 - 28 × 250 100 LA	6 78,1
		11,5	1176	4,25	MR C2I 140 - 28 × 250 100 LA	6 78,6
		14	941	1,9	MR C3I 100 - 24 × 200 90 L	4 99,9
15,3		881	1,4	MR ICI 100 - 19 × 200 90 L *	4 91,5	
15,1		894	1,4	MR ICI 100 - 24 × 200 90 L	4 92,9	
14,7		915	1,4	MR ICI 100 - 24 × 200 90 LC	6 61,2	
14,9		901	1,18	MR ICI 100 - 28 × 250 100 LA	6 60,2	
14,5		927	2,8	MR ICI 125 - 24 × 200 90 L	4 96,4	
17,3		778	0,85	MR ICI 81 - 24 × 200 90 LC	6 52	
18,3		737	1,7	MR ICI 100 - 19 × 200 90 L *	4 76,7	
18,3		735	1,5	MR ICI 100 - 24 × 200 90 L	4 76,4	
18,4		732	1,9	MR ICI 100 - 24 × 200 90 LC	6 48,9	
18,7		721	1,7	MR ICI 100 - 28 × 250 100 LA	6 48,2	
17,9		751	3,35	MR ICI 125 - 24 × 200 90 L	4 78,1	
21,2		635	0,9	MR ICI 80 - 19 × 200 90 L *	4 66	
21,5		625	0,85	MR ICI 80 - 24 × 200 90 L	4 65	
21,2		635	1,06	MR ICI 81 - 19 × 200 90 L *	4 66	
21,5		625	0,95	MR ICI 81 - 24 × 200 90 L	4 65	
21,6		622	0,95	MR ICI 80 - 24 × 200 90 LC	6 41,6	
21,6		622	1,06	MR ICI 81 - 24 × 200 90 LC	6 41,6	
22,9		588	2,12	MR ICI 100 - 24 × 200 90 L	4 61,2	
24,6		559	2,12	MR CI 100 - 24 × 200 90 LC	6 36,6	
24,6		559	2,12	MR CI 100 - 28 × 250 100 LA	6 36,6	
26,9		500	1,18	MR ICI 80 - 24 × 200 90 L	4 52	
26,9		500	1,32	MR ICI 81 - 24 × 200 90 L	4 52	
27		499	1,25	MR ICI 80 - 24 × 200 90 LC	6 33,3	
27		499	1,4	MR ICI 81 - 24 × 200 90 LC	6 33,3	
27,7		497	0,95	MR CI 80 - 24 × 200 90 LC	6 32,5	
27,7		497	1,18	MR CI 81 - 24 × 200 90 LC	6 32,5	
27,7		497	0,95	MR CI 80 - 28 × 250 100 LA	6 32,5	
27,7		497	1,18	MR CI 81 - 28 × 250 100 LA	6 32,5	
28,6		471	3	MR ICI 100 - 24 × 200 90 L	4 48,9	
29,9		460	2,36	MR CI 100 - 24 × 200 90 LC	6 30,1	
29,9		460	2,36	MR CI 100 - 28 × 250 100 LA	6 30,1	
35		385	0,85	MR ICI 64 - 24 × 200 90 L	4 40	
35,7		377	0,85	MR ICI 63 - 24 × 200 90 LC	6 25,2	
35,7		377	1	MR ICI 64 - 24 × 200 90 LC	6 25,2	
36		382	0,85	MR CI 64 - 24 × 200 90 LC	6 25	
33,7	400	1,4	MR ICI 80 - 24 × 200 90 L	4 41,6		
33,7	400	1,7	MR ICI 81 - 24 × 200 90 L	4 41,6		
34,2	393	1,7	MR ICI 80 - 24 × 200 90 LC	6 26,3		
34,2	393	2	MR ICI 81 - 24 × 200 90 LC	6 26,3		
34,6	397	1,5	MR CI 80 - 24 × 200 90 LC	6 26		
34,6	397	1,7	MR CI 81 - 24 × 200 90 LC	6 26		
34,6	397	1,5	MR CI 80 - 28 × 250 100 LA	6 26		
34,6	397	1,7	MR CI 81 - 28 × 250 100 LA	6 26		
35,1	383	3,35	MR ICI 100 - 24 × 200 90 L	4 39,8		
38,2	360	3,15	MR CI 100 - 24 × 200 90 L	4 36,6		
37,4	368	3	MR CI 100 - 24 × 200 90 LC	6 24,1		
37,4	368	3	MR CI 100 - 28 × 250 100 LA	6 24,1		
43,8	308	0,95	MR ICI 63 - 24 × 200 90 L	4 32		
43,8	308	1,12	MR ICI 64 - 24 × 200 90 L	4 32		
44,8	307	0,85	MR CI 64 - 24 × 200 90 L	4 31,3		
45	306	0,9	MR CI 63 - 24 × 200 90 LC	6 20		
45	306	1,06	MR CI 64 - 24 × 200 90 LC	6 20		
42	321	1,9	MR ICI 80 - 24 × 200 90 L	4 33,3		
42	321	2,12	MR ICI 81 - 24 × 200 90 L	4 33,3		
43,1	319	1,5	MR CI 80 - 24 × 200 90 L	4 32,5		
43,1	319	1,8	MR CI 81 - 24 × 200 90 L	4 32,5		
43,3	318	1,8	MR CI 80 - 24 × 200 90 LC	6 20,8		
43,3	318	2,12	MR CI 81 - 24 × 200 90 LC	6 20,8		
43,3	318	1,8	MR CI 80 - 28 × 250 100 LA	6 20,8		
43,3	318	2,12	MR CI 81 - 28 × 250 100 LA	6 20,8		
46,5	296	3,55	MR CI 100 - 24 × 200 90 L	4 30,1		

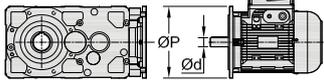
P_1 kW	n_2 min ⁻¹	M_2 N m	f_s		i
1)				2)	
1,5	10,3	1313	3,35	MR C2I 140 - 28 × 250 100 LA	6 87,8
	11	1193	1,12	MR C3I 100 - 24 × 200 90 L	4 127
	12,2	1101	1	MR ICI 100 - 19 × 200 90 L *	4 114
	11,8	1144	0,95	MR ICI 100 - 24 × 200 90 LC	6 76,4
	12,3	1095	1,18	MR ICI 100 - 28 × 250 100 LA	6 73,2
	11,4	1160	3	MR C3I 125 - 24 × 200 90 L	4 123
	11,6	1159	2	MR ICI 125 - 24 × 200 90 L	4 121
	11,5	1169	2,65	MR ICI 140 - 28 × 250 100 LA	6 78,1
	11,5	1176	4,25	MR C2I 140 - 28 × 250 100 LA	6 78,6
	14	941	1,9	MR C3I 100 - 24 × 200 90 L	4 99,9
	15,3	881	1,4	MR ICI 100 - 19 × 200 90 L *	4 91,5
	15,1	894	1,4	MR ICI 100 - 24 × 200 90 L	4 92,9
	14,7	915	1,4	MR ICI 100 - 24 × 200 90 LC	6 61,2
	14,9	901	1,18	MR ICI 100 - 28 × 250 100 LA	6 60,2
	14,5	927	2,8	MR ICI 125 - 24 × 200 90 L	4 96,4
	17,3	778	0,85	MR ICI 81 - 24 × 200 90 LC	6 52
	18,3	737	1,7	MR ICI 100 - 19 × 200 90 L *	4 76,7
	18,3	735	1,5	MR ICI 100 - 24 × 200 90 L	4 76,4
	18,4	732	1,9	MR ICI 100 - 24 × 200 90 LC	6 48,9
	18,7	721	1,7	MR ICI 100 - 28 × 250 100 LA	6 48,2
	17,9	751	3,35	MR ICI 125 - 24 × 200 90 L	4 78,1
	21,2	635	0,9	MR ICI 80 - 19 × 200 90 L *	4 66
	21,5	625	0,85	MR ICI 80 - 24 × 200 90 L	4 65
	21,2	635	1,06	MR ICI 81 - 19 × 200 90 L *	4 66
	21,5	625	0,95	MR ICI 81 - 24 × 200 90 L	4 65
	21,6	622			

13 - Selection tables (bevel helical gearmotors)

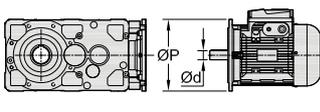

P_1 kW	n_2 min ⁻¹	M_2 N m	f_s		i		
1)				2)			
1,5	55,5	243	1,32	MR ICI 63 - 24 × 200	90 L 4	25,2	
	55,5	243	1,6	MR ICI 64 - 24 × 200	90 L 4	25,2	
	56	246	1,12	MR CI 63 - 24 × 200	90 L 4	25	
	56	246	1,32	MR CI 64 - 24 × 200	90 L 4	25	
	53,3	253	2,65	MR ICI 80 - 24 × 200	90 L 4	26,3	
	53,8	255	2,24	MR CI 80 - 24 × 200	90 L 4	26	
	53,8	255	2,5	MR CI 81 - 24 × 200	90 L 4	26	
	67,6	199	1,6	MR ICI 63 - 24 × 200	90 L 4	20,7	
	67,6	199	1,9	MR ICI 64 - 24 × 200	90 L 4	20,7	
	70	196	1,32	MR CI 63 - 24 × 200	90 L 4	20	
	70	196	1,7	MR CI 64 - 24 × 200	90 L 4	20	
	70,8	190	2,8	MR ICI 80 - 24 × 200	90 L 4	19,8	
	67,3	204	2,8	MR CI 80 - 24 × 200	90 L 4	20,8	
	87,5	157	1,7	MR CI 63 - 24 × 200	90 L 4	16	
	87,5	157	2,12	MR CI 64 - 24 × 200	90 L 4	16	
	111	124	2,5	MR CI 63 - 24 × 200	90 L 4	12,6	
	135	102	2,8	MR CI 63 - 24 × 200	90 L 4	10,4	
	175	78	2,8	MR CI 63 - 24 × 200	90 L 4	7,98	
	222	62	2,8	MR CI 63 - 24 × 200	90 L 4	6,31	
	1,85	5,73	2834	0,95	MR C3I 125 - 24 × 200	90 LB 4	244
		5,98	2778	1,5	MR C2I 140 - 28 × 250	100 LB 6	151
		5,85	2839	2,36	MR C2I 160 - 28 × 250	100 LB 6	154
		5,68	2924	3,15	MR C2I 180 - 28 × 250	100 LB 6	158
		7,17	2268	1,32	MR C3I 125 - 24 × 200	90 LB 4	195
		7,33	2265	1,9	MR C2I 140 - 28 × 250	100 LB 6	123
7,31		2271	2	MR ICI 160 - 28 × 250	100 LB 6	123	
6,97		2383	3,15	MR C2I 160 - 28 × 250	100 LB 6	129	
8,96		1814	1,7	MR C3I 125 - 24 × 200	90 LB 4	156	
9,22		1802	1,32	MR ICI 125 - 28 × 250	100 LB 6	97,7	
9,16		1812	2,36	MR C2I 140 - 28 × 250	100 LB 6	98,2	
10,3		1619	2,65	MR C2I 140 - 28 × 250	100 LB 6	87,8	
11		1472	0,9	MR C3I 100 - 24 × 200	90 LB 4	127	
12,3		1351	0,95	MR ICI 100 - 28 × 250	100 LB 6	73,2	
11,4		1430	2,5	MR C3I 125 - 24 × 200	90 LB 4	123	
11,6		1430	1,7	MR ICI 125 - 24 × 200	90 LB 4	121	
11,5		1442	2,12	MR ICI 140 - 28 × 250	100 LB 6	78,1	
11,5		1450	3,35	MR C2I 140 - 28 × 250	100 LB 6	78,6	
12,8		1296	3,55	MR C2I 140 - 28 × 250	100 LB 6	70,2	
14		1160	1,5	MR C3I 100 - 24 × 200	90 LB 4	99,9	
15,3		1086	1,18	MR ICI 100 - 19 × 200	90 LB * 4	91,5	
15,1		1102	1,18	MR ICI 100 - 24 × 200	90 LB 4	92,9	
14,5		1144	2,24	MR ICI 125 - 24 × 200	90 LB 4	96,4	
14,5		1144	2,65	MR ICI 140 - 24 × 200	90 LB 4	96,4	
18,3		909	1,4	MR ICI 100 - 19 × 200	90 LB * 4	76,7	
18,3		907	1,18	MR ICI 100 - 24 × 200	90 LB 4	76,4	
18,7		889	1,4	MR ICI 100 - 28 × 250	100 LB 6	48,2	
17,9		927	2,8	MR ICI 125 - 24 × 200	90 LB 4	78,1	
21,2		783	0,85	MR ICI 81 - 19 × 200	90 LB * 4	66	
22,9		725	1,7	MR ICI 100 - 24 × 200	90 LB 4	61,2	
24,6		690	1,7	MR CI 100 - 28 × 250	100 LB 6	36,6	
22,4		741	3,55	MR ICI 125 - 24 × 200	90 LB 4	62,5	
26,9		617	0,95	MR ICI 80 - 24 × 200	90 LB 4	52	
26,9		617	1,06	MR ICI 81 - 24 × 200	90 LB 4	52	
27,7		612	0,95	MR CI 81 - 28 × 250	100 LB 6	32,5	
28,6		580	2,36	MR ICI 100 - 24 × 200	90 LB 4	48,9	
29,9		568	1,9	MR CI 100 - 28 × 250	100 LB 6	30,1	
33,7		493	1,18	MR ICI 80 - 24 × 200	90 LB 4	41,6	
33,7		493	1,32	MR ICI 81 - 24 × 200	90 LB 4	41,6	
34,6		490	1,18	MR CI 80 - 28 × 250	100 LB 6	26	
34,6		490	1,32	MR CI 81 - 28 × 250	100 LB 6	26	
35,1		473	2,8	MR ICI 100 - 24 × 200	90 LB 4	39,8	
38,2		443	2,65	MR CI 100 - 24 × 200	90 LB 4	36,6	
37,4		454	2,5	MR CI 100 - 28 × 250	100 LB 6	24,1	
43,7		380	0,85	MR ICI 63 - 19 × 200	90 LB * 4	32	
43,7		380	1	MR ICI 64 - 19 × 200	90 LB * 4	32	
43,8		380	0,9	MR ICI 64 - 24 × 200	90 LB 4	32	

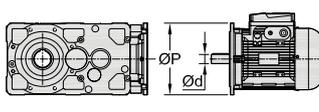
P_1 kW	n_2 min ⁻¹	M_2 N m	f_s		i	
1)				2)		
1,85	42	395	1,6	MR ICI 80 - 24 × 200	90 LB 4	33,3
	42	395	1,8	MR ICI 81 - 24 × 200	90 LB 4	33,3
	43,1	394	1,18	MR CI 80 - 24 × 200	90 LB 4	32,5
	43,1	394	1,5	MR CI 81 - 24 × 200	90 LB 4	32,5
	43,3	392	1,5	MR CI 80 - 28 × 250	100 LB 6	20,8
	43,3	392	1,7	MR CI 81 - 28 × 250	100 LB 6	20,8
	46,5	365	2,8	MR CI 100 - 24 × 200	90 LB 4	30,1
	55,5	299	1,06	MR ICI 63 - 24 × 200	90 LB 4	25,2
	55,5	299	1,25	MR ICI 64 - 24 × 200	90 LB 4	25,2
	56	303	0,9	MR CI 63 - 24 × 200	90 LB 4	25
	56	303	1,06	MR CI 64 - 24 × 200	90 LB 4	25
	53,3	312	2,12	MR ICI 80 - 24 × 200	90 LB 4	26,3
	53,3	312	2,5	MR ICI 81 - 24 × 200	90 LB 4	26,3
	53,8	315	1,8	MR CI 80 - 24 × 200	90 LB 4	26
	53,8	315	2,12	MR CI 81 - 24 × 200	90 LB 4	26
	58,1	292	3,75	MR CI 100 - 24 × 200	90 LB 4	24,1
	67,6	246	1,32	MR ICI 63 - 24 × 200	90 LB 4	20,7
	67,6	246	1,5	MR ICI 64 - 24 × 200	90 LB 4	20,7
	70	242	1,12	MR CI 63 - 24 × 200	90 LB 4	20
	70	242	1,32	MR CI 64 - 24 × 200	90 LB 4	20
	70,8	234	2,36	MR ICI 80 - 24 × 200	90 LB 4	19,8
	67,3	252	2,24	MR ICI 80 - 24 × 200	90 LB 4	20,8
	67,3	252	2,65	MR CI 81 - 24 × 200	90 LB 4	20,8
	87,5	194	1,4	MR CI 63 - 24 × 200	90 LB 4	16
	87,5	194	1,7	MR CI 64 - 24 × 200	90 LB 4	16
	84	202	3	MR CI 80 - 24 × 200	90 LB 4	16,7
	111	153	2	MR CI 63 - 24 × 200	90 LB 4	12,6
	111	153	2,5	MR CI 64 - 24 × 200	90 LB 4	12,6
	135	126	2,24	MR CI 63 - 24 × 200	90 LB 4	10,4
	135	126	2,5	MR CI 64 - 24 × 200	90 LB 4	10,4
	175	97	2,24	MR CI 63 - 24 × 200	90 LB 4	7,98
	175	97	2,5	MR CI 64 - 24 × 200	90 LB 4	7,98
222	76	2,24	MR CI 63 - 24 × 200	90 LB 4	6,31	
222	76	2,5	MR CI 64 - 24 × 200	90 LB 4	6,31	
2,2	5,98	3304	1,32	MR C2I 140 - 28 × 250	112 M 6	151
	5,85	3376	2	MR C2I 160 - 28 × 250	112 M 6	154
	5,68	3478	2,65	MR C2I 180 - 28 × 250	112 M 6	158
	7,17	2697	1,12	MR C3I 125 - 24 × 200	90 LC 4	195
	7,07	2735	0,95	MR C3I 125 - 28 × 250	100 LA 4	198
	7,1	2723	1	MR C3I 125 - 28 × 250	112 M 6	127
	7,33	2694	1,6	MR C2I 140 - 28 × 250	112 M 6	123
	7,31	2701	1,7	MR ICI 160 - 28 × 250	112 M 6	123
	6,97	2834	2,65	MR C2I 160 - 28 × 250	112 M 6	129
	8,96	2157	1,4	MR C3I 125 - 24 × 200	90 LC 4	156
	8,83	2188	1,4	MR C3I 125 - 28 × 250	100 LA 4	158
	9,22	2143	1,12	MR ICI 125 - 28 × 250	112 M 6	97,7
	9,3	2124	1,9	MR C2I 140 - 28 × 250	100 LA 4	151
	9,16	2155	2	MR C2I 140 - 28 × 250	112 M 6	98,2
	9,14	2161	2,65	MR ICI 160 - 28 × 250	112 M 6	98,5
	9,1	2170	2,8	MR C2I 160 - 28 × 250	100 LA 4	154
	11,4	1701	2	MR C3I 125 - 24 × 200	90 LC 4	123
	11	1750	1,5	MR C3I 125 - 28 × 250	100 LA 4	127
	11,6	1700	1,4	MR ICI 125 - 24 × 200	90 LC 4	121
	11,5	1714	1,5	MR ICI 125 - 28 × 250	112 M 6	78,1
	11,5	1714	1,8	MR ICI 140 - 28 × 250	112 M 6	78,1
	11,4	1732	2,36	MR C2I 140 - 28 × 250	100 LA 4	123
11,4	1736	2,65	MR ICI 160 - 28 × 250	100 LA 4	123	
14	1380	1,25	MR C3I 100 - 24 × 200	90 LC 4	99,9	
15,3	1291	0,95	MR ICI 100 - 19 × 200	90 LC * 4	91,5	
15,1	1311	0,95	MR ICI 100 - 24 × 200	90 LC 4	92,9	
14	1380	2,5	MR C3I 125 - 28 × 250	100 LA 4	100	
14,5	1360	1,9	MR ICI 125 - 24 × 200	90 LC 4	96,4	
14,3	1378	1,7	MR ICI 125 - 28 × 250	100 LA 4	97,7	
14,5	1360	2,24	MR ICI 140 - 24 × 200	90 LC 4	96,4	
14,3	1386	3,15	MR C2I 140 - 28 × 250	100 LA 4	98,2	
14,2	1389	4	MR ICI 160 - 28 × 250	100 LA 4	98,5	

1) Powers valid for continuous duty S1; **increase possible** for duty cycles S2 ... S10 (see ch. 1 «General specifications»): in which case M_2 increases and f_s decreases.

2) For complete designation when ordering see ch. 2.

* Mounting position **B5R** (see ch. 1.2).

13 - Selection tables (bevel helical gearmotors)

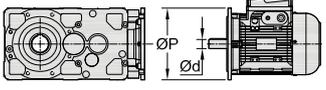

P_1 kW	n_2 min ⁻¹	M_2 N m	f_s		i
1)				2)	
2,2	16	1238	3,55	MR C2I 140 - 28 × 250 100 LA	4 87,8
18,3	1081	1,18		MR ICI 100 - 19 × 200 90 LC *	4 76,7
18,3	1078	1		MR ICI 100 - 24 × 200 90 LC	4 76,4
19,1	1033	1,25		MR ICI 100 - 28 × 250 100 LA	4 73,2
18,7	1057	1,18		MR ICI 100 - 28 × 250 112 M	6 48,2
17,9	1102	2,36		MR ICI 125 - 28 × 250 100 LA	4 78,1
17,9	1102	2,65		MR ICI 140 - 28 × 250 100 LA	4 78,1
17,8	1108	4,25		MR C2I 140 - 28 × 250 100 LA	4 78,6
19,9	990	4,25		MR C2I 140 - 28 × 250 100 LA	4 70,2
22,9	863	1,4		MR ICI 100 - 24 × 200 90 LC	4 61,2
23,2	850	1,25		MR ICI 100 - 28 × 250 100 LA	4 60,2
23,3	846	1,6		MR ICI 100 - 28 × 250 112 M	6 38,5
24,6	820	1,4		MR CI 100 - 28 × 250 112 M	6 36,6
22,1	894	2,8		MR ICI 125 - 28 × 250 100 LA	4 63,4
22,6	874	5		MR C2I 140 - 28 × 250 100 LA	4 62
25,3	781	5,3		MR C2I 140 - 28 × 250 100 LA	4 55,4
26,9	734	0,8		MR ICI 80 - 24 × 200 90 LC	4 52
26,9	734	0,9		MR ICI 81 - 24 × 200 90 LC	4 52
28,6	690	2		MR ICI 100 - 24 × 200 90 LC	4 48,9
29,1	680	1,8		MR ICI 100 - 28 × 250 100 LA	4 48,2
29,9	675	1,6		MR CI 100 - 28 × 250 112 M	6 30,1
27,6	715	3,75		MR ICI 125 - 28 × 250 100 LA	4 50,7
27,8	712	5,6		MR C2I 140 - 28 × 250 100 LA	4 50,4
33,7	587	1		MR ICI 80 - 24 × 200 90 LC	4 41,6
33,7	587	1,12		MR ICI 81 - 24 × 200 90 LC	4 41,6
34,6	583	1		MR CI 80 - 28 × 250 112 M	6 26
34,6	583	1,12		MR CI 81 - 28 × 250 112 M	6 26
35,1	562	2,36		MR ICI 100 - 24 × 200 90 LC	4 39,8
36,3	544	2,5		MR ICI 100 - 28 × 250 100 LA	4 38,5
38,2	527	2,12		MR CI 100 - 24 × 200 90 LC	4 36,6
38,2	527	2,12		MR CI 100 - 28 × 250 100 LA	4 36,6
37,4	540	2		MR CI 100 - 28 × 250 112 M	6 24,1
43,7	452	0,85		MR ICI 64 - 19 × 200 90 LC *	4 32
42	470	1,32		MR ICI 80 - 24 × 200 90 LC	4 33,3
42	470	1,5		MR ICI 81 - 24 × 200 90 LC	4 33,3
43,1	468	1		MR CI 80 - 24 × 200 90 LC	4 32,5
43,1	468	1,25		MR CI 81 - 24 × 200 90 LC	4 32,5
43,1	468	1		MR CI 80 - 28 × 250 100 LA	4 32,5
43,1	468	1,25		MR CI 81 - 28 × 250 100 LA	4 32,5
43,3	466	1,25		MR CI 80 - 28 × 250 112 M	6 20,8
43,3	466	1,4		MR CI 81 - 28 × 250 112 M	6 20,8
44,6	443	3,55		MR ICI 100 - 24 × 200 90 LC	4 31,4
44,6	443	3		MR ICI 100 - 28 × 250 100 LA	4 31,4
46,5	434	2,36		MR CI 100 - 24 × 200 90 LC	4 30,1
46,5	434	2,36		MR CI 100 - 28 × 250 100 LA	4 30,1
55,5	356	0,9		MR ICI 63 - 24 × 200 90 LC	4 25,2
55,5	356	1,06		MR ICI 64 - 24 × 200 90 LC	4 25,2
56	360	0,9		MR CI 64 - 24 × 200 90 LC	4 25
53,3	371	1,8		MR ICI 80 - 24 × 200 90 LC	4 26,3
53,3	371	2,12		MR ICI 81 - 24 × 200 90 LC	4 26,3
53,8	375	1,5		MR CI 80 - 24 × 200 90 LC	4 26
53,8	375	1,7		MR CI 81 - 24 × 200 90 LC	4 26
53,8	375	1,5		MR CI 80 - 28 × 250 100 LA	4 26
53,8	375	1,7		MR CI 81 - 28 × 250 100 LA	4 26
56,6	349	4,5		MR ICI 100 - 28 × 250 100 LA	4 24,7
67,6	292	1,12		MR ICI 63 - 24 × 200 90 LC	4 20,7
67,6	292	1,25		MR ICI 64 - 24 × 200 90 LC	4 20,7
70	288	0,95		MR CI 63 - 24 × 200 90 LC	4 20
70	288	1,12		MR CI 64 - 24 × 200 90 LC	4 20
70,8	279	1,9		MR ICI 80 - 24 × 200 90 LC	4 19,8
70,8	279	2,36		MR ICI 81 - 24 × 200 90 LC	4 19,8
67,3	300	1,9		MR CI 80 - 24 × 200 90 LC	4 20,8
67,3	300	2,24		MR CI 81 - 24 × 200 90 LC	4 20,8
67,3	300	1,9		MR CI 80 - 28 × 250 100 LA	4 20,8
67,3	300	2,24		MR CI 81 - 28 × 250 100 LA	4 20,8
67,9	291	4,75		MR ICI 100 - 28 × 250 100 LA	4 20,6
87,5	231	1,18		MR CI 63 - 24 × 200 90 LC	4 16
87,5	231	1,4		MR CI 64 - 24 × 200 90 LC	4 16
84	240	2,5		MR CI 80 - 24 × 200 90 LC	4 16,7
84	240	2,5		MR CI 80 - 28 × 250 100 LA	4 16,7
84	240	2,8		MR CI 81 - 28 × 250 100 LA	4 16,7

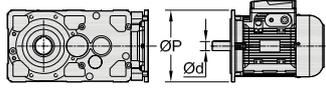
P_1 kW	n_2 min ⁻¹	M_2 N m	f_s		i
1)				2)	
2,2	111	182	1,7	MR CI 63 - 24 × 200 90 LC	4 12,6
111	182	2		MR CI 64 - 24 × 200 90 LC	4 12,6
107	189	3,35		MR CI 80 - 28 × 250 100 LA	4 13,1
135	149	1,9		MR CI 63 - 24 × 200 90 LC	4 10,4
135	149	2		MR CI 64 - 24 × 200 90 LC	4 10,4
142	142	3,75		MR CI 80 - 28 × 250 100 LA	4 9,88
175	115	1,9		MR CI 63 - 24 × 200 90 LC	4 7,98
175	115	2		MR CI 64 - 24 × 200 90 LC	4 7,98
182	111	3,75		MR CI 80 - 28 × 250 100 LA	4 7,71
222	91	1,9		MR CI 63 - 24 × 200 90 LC	4 6,31
222	91	2		MR CI 64 - 24 × 200 90 LC	4 6,31
227	89	3,75		MR CI 80 - 28 × 250 100 LA	4 6,16
3	5,98	4506	0,95	MR C2I 140 - 28 × 250 112 MC	6 151
5,98	4506	0,95		MR C2I 140 - 38 × 300 132 S	6 151
5,85	4604	1,4		MR C2I 160 - 28 × 250 112 MC	6 154
5,85	4604	1,4		MR C2I 160 - 38 × 300 132 S	6 154
5,68	4742	2		MR C2I 180 - 28 × 250 112 MC	6 158
5,68	4742	2		MR C2I 180 - 38 × 300 132 S	6 158
5,94	4533	3		MR C2I 200 - 38 × 300 132 S	6 151
7,33	3674	1,18		MR C2I 140 - 28 × 250 112 MC	6 123
7,33	3674	1,18		MR C2I 140 - 38 × 300 132 S	6 123
7,31	3683	1,25		MR ICI 160 - 28 × 250 112 MC	6 123
6,97	3865	2		MR C2I 160 - 28 × 250 112 MC	6 129
6,97	3865	2		MR C2I 160 - 38 × 300 132 S	6 129
6,93	3884	2,5		MR C2I 180 - 28 × 250 112 MC	6 130
6,93	3884	2,5		MR C2I 180 - 38 × 300 132 S	6 130
7,7	3499	2,65		MR ICI 200 - 38 × 300 132 S	6 117
8,83	2984	1		MR C3I 125 - 28 × 250 100 LB	4 158
9,3	2896	1,4		MR C2I 140 - 28 × 250 100 LB	4 151
9,16	2939	1,5		MR C2I 140 - 28 × 250 112 MC	6 98,2
9,16	2939	1,5		MR C2I 140 - 38 × 300 132 S	6 98,2
9,14	2946	1,9		MR ICI 160 - 28 × 250 112 MC	6 98,5
9,14	2959	2,12		MR C2I 160 - 28 × 250 100 LB	4 154
8,71	3092	2,5		MR C2I 160 - 28 × 250 112 MC	6 103
8,71	3092	2,5		MR C2I 160 - 38 × 300 132 S	6 103
8,87	3035	2		MR ICI 180 - 28 × 250 112 MC	6 101
8,83	3049	3		MR C2I 180 - 28 × 250 100 LB	4 158
9,62	2799	4		MR ICI 200 - 38 × 300 132 S	6 93,5
11	2387	1,12		MR C3I 125 - 28 × 250 100 LB	4 127
11,6	2319	1		MR ICI 125 - 24 × 200 100 LB *	4 121
11,5	2338	1,12		MR ICI 125 - 28 × 250 112 MC	6 78,1
11,5	2338	1,32		MR ICI 140 - 28 × 250 112 MC	6 78,1
11,4	2362	1,8		MR C2I 140 - 28 × 250 100 LB	4 123
11,4	2368	1,9		MR ICI 160 - 28 × 250 100 LB	4 123
11,5	2338	2,36		MR ICI 160 - 28 × 250 112 MC	6 78,1
10,8	2485	3		MR C2I 160 - 28 × 250 100 LB	4 129
11,5	2338	4,75		MR ICI 200 - 38 × 300 132 S	6 78,1
14	1882	1,9		MR C3I 125 - 28 × 250 100 LB	4 100
14,5	1855	1,4		MR ICI 125 - 24 × 200 100 LB *	4 96,4
14,3	1879	1,25		MR ICI 125 - 28 × 250 100 LB	4 97,7
14,2	1897	1,32		MR ICI 125 - 28 × 250 112 MC	6 63,4
14,2	1899	1,25		MR ICI 125 - 38 × 300 132 S	6 63,4
14,5	1855	1,6		MR ICI 140 - 24 × 200 100 LB *	4 96,4
14,2	1897	1,6		MR ICI 140 - 28 × 250 112 MC	6 63,4
14,3	1889	2,24		MR C2I 140 - 28 × 250 100 LB	4 98,2
14,2	1894	3		MR ICI 160 - 28 × 250 100 LB	4 98,5
16	1688	2,5		MR C2I 140 - 28 × 250 100 LB	4 87,8
18,7	1442	0,85		MR ICI 100 - 28 × 250 112 MC	6 48,2
17,9	1503	1,7		MR ICI 125 - 28 × 250 100 LB	4 78,1
17,9	1503	2		MR ICI 140 - 28 × 250 100 LB	4 78,1
17,7	1518	2,36		MR ICI 140 - 28 × 250 112 MC	6 50,7
17,7	1519	1,9		MR ICI 140 - 38 × 300 132 S	6 50,8
17,8	1511	3		MR C2I 140 - 28 × 250 100 LB	4 78,6
17,9	1503	3,75		MR ICI 160 - 28 × 250 100 LB	4 78,1
19,9	1351	3,15		MR C2I 140 - 28 × 250 100 LB	4 70,2

1) Powers valid for continuous duty S1; **increase possible** for duty cycles S2 ... S10 (see ch. 1 «General specifications»); in which case M_2 increases and f_s decreases.

2) For complete designation when ordering see ch. 2.

* Mounting position **B5R** (see ch. 1.2).

13 - Selection tables (bevel helical gearmotors)

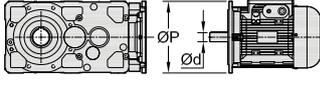

P_1 kW	n_2 min ⁻¹	M_2 N m	f_s		i	
1)				2)		
3	22,9	1176	1,06	MR ICI 100 - 24 × 200	100 LB * 4	61,2
	23,2	1159	0,95	MR ICI 100 - 28 × 250	100 LB 4	60,2
	23,3	1153	1,18	MR ICI 100 - 28 × 250	112 MC 6	38,5
	24,6	1119	1,06	MR CI 100 - 28 × 250	112 MC 6	36,6
	22,1	1219	2,12	MR ICI 125 - 28 × 250	100 LB 4	63,4
	22,6	1192	3,75	MR C2I 140 - 28 × 250	100 LB 4	62
	25,3	1065	4	MR C2I 140 - 28 × 250	100 LB 4	55,4
	29,1	927	1,32	MR ICI 100 - 28 × 250	100 LB 4	48,2
	29,9	920	1,18	MR CI 100 - 28 × 250	112 MC 6	30,1
	29,9	920	1,18	MR CI 100 - 38 × 300	132 S 6	30,1
	27,6	976	2,65	MR ICI 125 - 28 × 250	100 LB 4	50,7
	28,8	955	2,12	MR CI 125 - 38 × 300	132 S 6	31,3
	27,8	970	4,25	MR C2I 140 - 28 × 250	100 LB 4	50,4
	33,7	800	0,85	MR ICI 81 - 24 × 200	100 LB * 4	41,6
	34,6	795	0,85	MR CI 81 - 28 × 250	112 MC 6	26
	36,3	741	1,8	MR ICI 100 - 28 × 250	100 LB 4	38,5
	38,2	719	1,6	MR CI 100 - 28 × 250	100 LB 4	36,6
	37,4	736	1,5	MR CI 100 - 28 × 250	112 MC 6	24,1
	37,4	736	1,5	MR CI 100 - 38 × 300	132 S 6	24,1
	34,5	780	3,55	MR ICI 125 - 28 × 250	100 LB 4	40,6
	36	764	3,35	MR CI 125 - 38 × 300	132 S 6	25
	42	641	0,95	MR ICI 80 - 24 × 200	100 LB * 4	33,3
	42	641	1,06	MR ICI 81 - 24 × 200	100 LB * 4	33,3
	43,1	638	0,9	MR CI 81 - 28 × 250	100 LB 4	32,5
	43,3	636	0,9	MR CI 80 - 28 × 250	112 MC 6	20,8
	43,3	636	1,06	MR CI 81 - 28 × 250	112 MC 6	20,8
	44,6	604	2,12	MR ICI 100 - 28 × 250	100 LB 4	31,4
	46,5	592	1,8	MR CI 100 - 28 × 250	100 LB 4	30,1
	46,7	589	2,24	MR CI 100 - 28 × 250	112 MC 6	19,3
	46,7	589	2,24	MR CI 100 - 38 × 300	132 S 6	19,3
	45	611	4,25	MR CI 125 - 38 × 300	132 S 6	20
	53,3	506	1,32	MR ICI 80 - 24 × 200	100 LB * 4	26,3
	53,3	506	1,5	MR ICI 81 - 24 × 200	100 LB * 4	26,3
	53,8	511	1,12	MR CI 80 - 28 × 250	100 LB 4	26
	53,8	511	1,25	MR CI 81 - 28 × 250	100 LB 4	26
	56,6	476	3,35	MR ICI 100 - 28 × 250	100 LB 4	24,7
	58,1	473	2,24	MR CI 100 - 28 × 250	100 LB 4	24,1
	70	393	0,85	MR CI 64 - 24 × 200	100 LB * 4	20
	70,8	380	1,4	MR ICI 80 - 24 × 200	100 LB * 4	19,8
	70,8	380	1,7	MR ICI 81 - 24 × 200	100 LB * 4	19,8
	67,3	409	1,4	MR CI 80 - 28 × 250	100 LB 4	20,8
	67,3	409	1,6	MR CI 81 - 28 × 250	100 LB 4	20,8
67,9	396	3,55	MR ICI 100 - 28 × 250	100 LB 4	20,6	
72,6	379	3,35	MR CI 100 - 28 × 250	100 LB 4	19,3	
87,5	314	1,06	MR CI 64 - 24 × 200	100 LB * 4	16	
84	327	1,8	MR CI 80 - 28 × 250	100 LB 4	16,7	
84	327	2	MR CI 81 - 28 × 250	100 LB 4	16,7	
89,2	308	3,55	MR CI 100 - 28 × 250	100 LB 4	15,7	
111	248	1,5	MR CI 64 - 24 × 200	100 LB * 4	12,6	
107	258	2,5	MR CI 80 - 28 × 250	100 LB 4	13,1	
113	243	5,3	MR CI 100 - 28 × 250	100 LB 4	12,4	
135	204	1,5	MR CI 64 - 24 × 200	100 LB * 4	10,4	
142	194	2,65	MR CI 80 - 28 × 250	100 LB 4	9,88	
175	157	1,5	MR CI 64 - 24 × 200	100 LB * 4	7,98	
182	151	2,65	MR CI 80 - 28 × 250	100 LB 4	7,71	
222	124	1,5	MR CI 64 - 24 × 200	100 LB * 4	6,31	
227	121	2,65	MR CI 80 - 28 × 250	100 LB 4	6,16	
4	5,85	6138	1,06	MR C2I 160 - 38 × 300	132 M 6	154
	5,68	6323	1,5	MR C2I 180 - 38 × 300	132 M 6	158
	5,94	6044	2,24	MR C2I 200 - 38 × 300	132 M 6	151
	5,77	6226	3	MR C2I 225 - 38 × 300	132 M 6	156
	6,97	5153	1,5	MR C2I 160 - 38 × 300	132 M 6	129
	6,93	5179	1,8	MR C2I 180 - 38 × 300	132 M 6	130
	7,7	4665	2	MR ICI 200 - 38 × 300	132 M 6	117
	7,08	5074	3,15	MR C2I 200 - 38 × 300	132 M 6	127

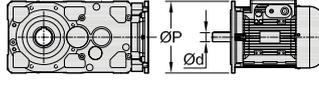
P_1 kW	n_2 min ⁻¹	M_2 N m	f_s		i	
1)				2)		
4	9,3	3862	1	MR C2I 140 - 28 × 250	112 M 4	151
	9,16	3919	1,12	MR C2I 140 - 38 × 300	132 M 6	98,2
	9,1	3946	1,6	MR C2I 160 - 28 × 250	112 M 4	154
	8,83	4065	2,24	MR C2I 180 - 28 × 250	112 M 4	158
	9,62	3732	3	MR ICI 200 - 38 × 300	132 M 6	93,5
	11	3183	0,85	MR C3I 125 - 28 × 250	112 M 4	127
	11,4	3149	1,32	MR C2I 140 - 28 × 250	112 M 4	123
	11,4	3157	1,5	MR ICI 160 - 28 × 250	112 M 4	123
	10,8	3313	2,24	MR C2I 160 - 28 × 250	112 M 4	129
	11,5	3117	3,55	MR ICI 200 - 38 × 300	132 M 6	78,1
	14	2509	1,4	MR C3I 125 - 28 × 250	112 M 4	100
	14,5	2473	1,06	MR ICI 125 - 24 × 200	112 M * 4	96,4
	14,3	2505	0,95	MR ICI 125 - 28 × 250	112 M 4	97,7
	14,5	2473	1,18	MR ICI 140 - 24 × 200	112 M * 4	96,4
	14,3	2519	1,7	MR C2I 140 - 28 × 250	112 M 4	98,2
	14,2	2525	2,24	MR ICI 160 - 28 × 250	112 M 4	98,5
	13,5	2650	2,65	MR C2I 160 - 28 × 250	112 M 4	103
	13,8	2601	2,36	MR ICI 180 - 28 × 250	112 M 4	101
	16	2251	1,9	MR C2I 140 - 28 × 250	112 M 4	87,8
	15,5	2318	3,35	MR C2I 160 - 28 × 250	112 M 4	90,4
	17,9	2004	1,25	MR ICI 125 - 28 × 250	112 M 4	78,1
	17,9	2004	1,5	MR ICI 140 - 28 × 250	112 M 4	78,1
	17,7	2025	1,5	MR ICI 140 - 38 × 300	132 M 6	50,8
	17,8	2015	2,24	MR C2I 140 - 28 × 250	112 M 4	78,6
	17,9	2004	2,8	MR ICI 160 - 28 × 250	112 M 4	78,1
	19,9	1801	2,36	MR C2I 140 - 28 × 250	112 M 4	70,2
	22,9	1569	0,8	MR ICI 100 - 24 × 200	112 M * 4	61,2
	22,1	1626	1,6	MR ICI 125 - 28 × 250	112 M 4	63,4
	22,1	1626	1,8	MR ICI 140 - 28 × 250	112 M 4	63,4
	22,6	1589	2,8	MR C2I 140 - 28 × 250	112 M 4	62
	22,4	1603	3,55	MR ICI 160 - 28 × 250	112 M 4	62,5
	25,3	1420	3	MR C2I 140 - 28 × 250	112 M 4	55,4
	29,1	1236	1	MR ICI 100 - 28 × 250	112 M 4	48,2
	27,6	1301	2	MR ICI 125 - 28 × 250	112 M 4	50,7
	28,8	1273	1,6	MR CI 125 - 38 × 300	132 M 6	31,3
	27,6	1301	2,8	MR ICI 140 - 28 × 250	112 M 4	50,7
	27,8	1294	3,15	MR C2I 140 - 28 × 250	112 M 4	50,4
	36,3	989	1,4	MR ICI 100 - 28 × 250	112 M 4	38,5
	38,2	959	1,18	MR CI 100 - 28 × 250	112 M 4	36,6
	37,4	982	1,12	MR CI 100 - 38 × 300	132 M 6	24,1
	34,5	1041	2,65	MR ICI 125 - 28 × 250	112 M 4	40,6
	36	1019	2,5	MR CI 125 - 38 × 300	132 M 6	25
44,6	805	1,6	MR ICI 100 - 28 × 250	112 M 4	31,4	
46,5	789	1,32	MR CI 100 - 28 × 250	112 M 4	30,1	
46,7	785	1,7	MR CI 100 - 38 × 300	132 M 6	19,3	
43,8	820	3,35	MR ICI 125 - 28 × 250	112 M 4	32	
45	815	3,15	MR CI 125 - 38 × 300	132 M 6	20	
53,8	681	0,85	MR CI 80 - 28 × 250	112 M 4	26	
53,8	681	0,95	MR CI 81 - 28 × 250	112 M 4	26	
56,6	635	2,5	MR ICI 100 - 28 × 250	112 M 4	24,7	
58,1	631	1,7	MR CI 100 - 28 × 250	112 M 4	24,1	
53,3	674	4,25	MR ICI 125 - 28 × 250	112 M 4	26,3	
56,3	652	4	MR CI 125 - 38 × 300	132 M 6	16	
67,3	545	1,06	MR CI 80 - 28 × 250	112 M 4	20,8	
67,3	545	1,18	MR CI 81 - 28 × 250	112 M 4	20,8	
67,9	528	2,65	MR ICI 100 - 28 × 250	112 M 4	20,6	
72,6	505	2,5	MR CI 100 - 28 × 250	112 M 4	19,3	
84	437	1,32	MR CI 80 - 28 × 250	112 M 4	16,7	
84	437	1,5	MR CI 81 - 28 × 250	112 M 4	16,7	
89,2	411	2,65	MR CI 100 - 28 × 250	112 M 4	15,7	
107	344	1,9	MR CI 80 - 28 × 250	112 M 4	13,1	
107	344	2,24	MR CI 81 - 28 × 250	112 M 4	13,1	
113	324	4	MR CI 100 - 28 × 250	112 M 4	12,4	
142	259	2	MR CI 80 - 28 × 250	112 M 4	9,88	
142	259	2,5	MR CI 81 - 28 × 250	112 M 4	9,88	

1) Powers valid for continuous duty S1; **increase possible** for duty cycles S2 ... S10 (see ch. 1 «General specifications»): in which case M_2 increases and f_s decreases.

2) For complete designation when ordering see ch. 2.

* Mounting position **B5R** (see ch. 1.2).

13 - Selection tables (bevel helical garmotors)

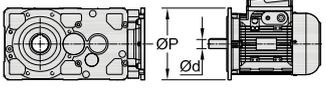

P_1 kW	n_2 min ⁻¹	M_2 N m	f_s		i
1)				2)	
4	182	202	2	MR CI 80 - 28 × 250 112 M	4 7,71
	182	202	2,5	MR CI 81 - 28 × 250 112 M	4 7,71
	227	161	2	MR CI 80 - 28 × 250 112 M	4 6,16
	227	161	2,5	MR CI 81 - 28 × 250 112 M	4 6,16
5,5	5,68	8694	1,06	MR C2I 180 - 38 × 300 132 MB	6 158
	5,94	8310	1,6	MR C2I 200 - 38 × 300 132 MB	6 151
	5,77	8560	2,24	MR C2I 225 - 38 × 300 132 MB	6 156
	6,97	7086	1,06	MR C2I 160 - 38 × 300 132 MB	6 129
	6,93	7121	1,32	MR C2I 180 - 38 × 300 132 MB	6 130
	7,7	6414	1,5	MR ICI 200 - 38 × 300 132 MB	6 117
	7,08	6977	2,24	MR C2I 200 - 38 × 300 132 MB	6 127
	7,18	6873	2,65	MR C2I 225 - 38 × 300 132 MB	6 125
	9,1	5426	1,18	MR C2I 160 - 28 × 250 112 MC	4 154
	9,1	5426	1,18	MR C2I 160 - 38 × 300 132 S	4 154
	8,83	5589	1,6	MR C2I 180 - 28 × 250 112 MC	4 158
	8,83	5589	1,6	MR C2I 180 - 38 × 300 132 S	4 158
	8,67	5697	1,7	MR C2I 180 - 38 × 300 132 MB	6 104
	9,62	5131	2,24	MR ICI 200 - 38 × 300 132 MB	6 93,5
	9,24	5342	2,36	MR C2I 200 - 38 × 300 132 S	4 151
	8,97	5503	3,35	MR C2I 225 - 38 × 300 132 S	4 156
	10,3	4814	0,9	MR C2I 140 - 38 × 300 132 MB	6 87,8
	11,4	4330	0,95	MR C2I 140 - 28 × 250 112 MC	4 123
	11,4	4330	0,95	MR C2I 140 - 38 × 300 132 S	4 123
	11,5	4310	1,12	MR C2I 140 - 38 × 300 132 MB	6 78,6
	11,4	4341	1,06	MR ICI 160 - 28 × 250 112 MC	4 123
	11,4	4314	1,06	MR ICI 160 - 38 × 300 132 MB	6 78,6
	10,8	4555	1,6	MR C2I 160 - 28 × 250 112 MC	4 129
	10,8	4555	1,6	MR C2I 160 - 38 × 300 132 S	4 129
	10,8	4578	2	MR C2I 180 - 28 × 250 112 MC	4 130
	10,8	4578	2	MR C2I 180 - 38 × 300 132 S	4 130
	12	4124	2,24	MR ICI 200 - 38 × 300 132 S	4 117
	11	4485	3,35	MR C2I 200 - 38 × 300 132 S	4 127
	14,3	3464	1,25	MR C2I 140 - 28 × 250 112 MC	4 98,2
	14,3	3464	1,25	MR C2I 140 - 38 × 300 132 S	4 98,2
	14,2	3472	1,6	MR ICI 160 - 28 × 250 112 MC	4 98,5
	14,3	3451	1,6	MR ICI 160 - 38 × 300 132 MB	6 62,9
	13,5	3644	2	MR C2I 160 - 28 × 250 112 MC	4 103
	13,5	3644	2	MR C2I 160 - 38 × 300 132 S	4 103
	13,8	3577	1,7	MR ICI 180 - 28 × 250 112 MC	4 101
	13,9	3555	1,7	MR ICI 180 - 38 × 300 132 MB	6 64,8
	13,5	3662	2,65	MR C2I 180 - 38 × 300 132 S	4 104
	15	3299	3,35	MR ICI 200 - 38 × 300 132 S	4 93,5
	16	3095	1,4	MR C2I 140 - 28 × 250 112 MC	4 87,8
	16	3095	1,4	MR C2I 140 - 38 × 300 132 S	4 87,8
	15,5	3188	2,5	MR C2I 160 - 28 × 250 112 MC	4 90,4
	15,5	3188	2,5	MR C2I 160 - 38 × 300 132 S	4 90,4
	17,9	2755	0,95	MR ICI 125 - 28 × 250 112 MC	4 78,1
	17,7	2785	0,9	MR ICI 125 - 38 × 300 132 MB	6 50,8
	17,9	2755	1,06	MR ICI 140 - 28 × 250 112 MC	4 78,1
	17,7	2785	1,06	MR ICI 140 - 38 × 300 132 MB	6 50,8
	17,8	2771	1,7	MR C2I 140 - 28 × 250 112 MC	4 78,6
	17,8	2771	1,7	MR C2I 140 - 38 × 300 132 S	4 78,6
	17,9	2755	2	MR ICI 160 - 28 × 250 112 MC	4 78,1
	17,8	2773	1,6	MR ICI 160 - 38 × 300 132 S	4 78,6
	16,9	2915	2,36	MR C2I 160 - 38 × 300 132 S	4 82,7
	17,4	2838	2,12	MR ICI 180 - 28 × 250 112 MC	4 80,5
17,4	2844	2,65	MR ICI 180 - 38 × 300 132 MB	6 51,8	
17,9	2755	4	MR ICI 200 - 38 × 300 132 S	4 78,1	
19,9	2476	1,7	MR C2I 140 - 28 × 250 112 MC	4 70,2	
19,9	2476	1,7	MR C2I 140 - 38 × 300 132 S	4 70,2	
19,4	2550	3	MR C2I 160 - 38 × 300 132 S	4 72,3	
22,1	2236	1,12	MR ICI 125 - 28 × 250 112 MC	4 63,4	
22,1	2238	1,06	MR ICI 125 - 38 × 300 132 S	4 63,4	
22,2	2228	1,18	MR ICI 125 - 38 × 300 132 MB	6 40,6	
22,1	2236	1,32	MR ICI 140 - 28 × 250 112 MC	4 63,4	
22,2	2228	1,6	MR ICI 140 - 38 × 300 132 MB	6 40,6	
22,6	2185	2	MR C2I 140 - 28 × 250 112 MC	4 62	
22,6	2185	2	MR C2I 140 - 38 × 300 132 S	4 62	
22,3	2218	2,5	MR ICI 160 - 38 × 300 132 S	4 62,9	
21,5	2299	3	MR C2I 160 - 38 × 300 132 S	4 65,2	

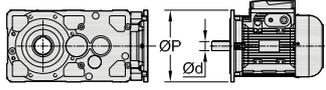
P_1 kW	n_2 min ⁻¹	M_2 N m	f_s		i
1)				2)	
5,5	25,3	1952	2,12	MR C2I 140 - 38 × 300 132 S	4 55,4
	27,6	1789	1,5	MR ICI 125 - 28 × 250 112 MC	4 50,7
	27,6	1790	1,4	MR ICI 125 - 38 × 300 132 S	4 50,8
	28,8	1751	1,18	MR CI 125 - 38 × 300 132 MB	6 31,3
	27,6	1789	2	MR ICI 140 - 28 × 250 112 MC	4 50,7
	27,6	1790	1,6	MR ICI 140 - 38 × 300 132 S	4 50,8
	28,1	1756	2	MR ICI 140 - 38 × 300 132 MB	6 32
	27,8	1779	2,36	MR C2I 140 - 38 × 300 132 S	4 50,4
	27,8	1775	3,15	MR ICI 160 - 38 × 300 132 S	4 50,3
	31,1	1590	2,65	MR C2I 140 - 38 × 300 132 S	4 45,1
	36,3	1359	1	MR ICI 100 - 28 × 250 112 MC	4 38,5
	37,4	1350	0,8	MR CI 100 - 38 × 300 132 MB	6 24,1
	34,5	1431	2	MR ICI 125 - 28 × 250 112 MC	4 40,6
	34,5	1432	1,8	MR ICI 125 - 38 × 300 132 S	4 40,6
	36	1401	1,8	MR CI 125 - 38 × 300 132 MB	6 25
	35	1410	2,5	MR ICI 140 - 28 × 250 112 MC	4 40
	34,5	1432	2,5	MR ICI 140 - 38 × 300 132 S	4 40,6
	36,2	1364	3	MR C2I 140 - 38 × 300 132 S	4 38,7
	37,3	1324	3,15	MR C2I 140 - 38 × 300 132 S	4 37,5
	44,6	1107	1,18	MR ICI 100 - 28 × 250 112 MC	4 31,4
	46,5	1085	0,95	MR CI 100 - 28 × 250 112 MC	4 30,1
	46,5	1085	0,95	MR CI 100 - 38 × 300 132 S	4 30,1
	46,7	1080	1,25	MR CI 100 - 38 × 300 132 MB	6 19,3
	43,1	1146	2,5	MR ICI 125 - 38 × 300 132 S	4 32,5
	44,8	1126	1,8	MR CI 125 - 38 × 300 132 S	4 31,3
	45	1121	2,36	MR CI 125 - 38 × 300 132 MB	6 20
	43,5	1135	3,15	MR C2I 140 - 38 × 300 132 S	4 32,2
	47,1	1049	4	MR C2I 140 - 38 × 300 132 S	4 29,8
	56,6	873	1,8	MR ICI 100 - 28 × 250 112 MC	4 24,7
	58,1	868	1,25	MR CI 100 - 28 × 250 112 MC	4 24,1
	58,1	868	1,25	MR CI 100 - 38 × 300 132 S	4 24,1
	54,7	903	3	MR ICI 125 - 38 × 300 132 S	4 25,6
	56	900	2,8	MR CI 125 - 38 × 300 132 S	4 25
	67,3	749	0,9	MR CI 81 - 28 × 250 112 MC	4 20,8
	67,9	727	1,9	MR ICI 100 - 28 × 250 112 MC	4 20,6
	72,6	694	1,9	MR CI 100 - 28 × 250 112 MC	4 19,3
	72,6	694	1,9	MR CI 100 - 38 × 300 132 S	4 19,3
	66,5	742	3,75	MR ICI 125 - 38 × 300 132 S	4 21
	70	720	3,55	MR CI 125 - 38 × 300 132 S	4 20
	84	600	1	MR CI 80 - 28 × 250 112 MC	4 16,7
	84	600	1,12	MR CI 81 - 28 × 250 112 MC	4 16,7
	89,2	565	2	MR CI 100 - 28 × 250 112 MC	4 15,7
89,2	565	2	MR CI 100 - 38 × 300 132 S	4 15,7	
87,5	576	4,25	MR CI 125 - 38 × 300 132 S	4 16	
107	473	1,4	MR CI 80 - 28 × 250 112 MC	4 13,1	
107	473	1,6	MR CI 81 - 28 × 250 112 MC	4 13,1	
113	446	2,8	MR CI 100 - 28 × 250 112 MC	4 12,4	
113	446	2,8	MR CI 100 - 38 × 300 132 S	4 12,4	
142	356	1,5	MR CI 80 - 28 × 250 112 MC	4 9,88	
142	356	1,8	MR CI 81 - 28 × 250 112 MC	4 9,88	
136	371	2,8	MR CI 100 - 28 × 250 112 MC	4 10,3	
136	371	2,8	MR CI 100 - 38 × 300 132 S	4 10,3	
182	278	1,5	MR CI 80 - 28 × 250 112 MC	4 7,71	
182	278	1,8	MR CI 81 - 28 × 250 112 MC	4 7,71	
174	290	2,8	MR CI 100 - 38 × 300 132 S	4 8,06	
227	222	1,5	MR CI 80 - 28 × 250 112 MC	4 6,16	
227	222	1,8	MR CI 81 - 28 × 250 112 MC	4 6,16	
217	233	2,8	MR CI 100 - 38 × 300 132 S	4 6,46	
7,5	5,94	11332	1,18	MR C2I 200 - 38 × 300 132 MC	6 151
	5,94	11332	1,18	MR C2I 200 - 42 × 350 160 M	6 151
	5,77	11673	1,6	MR C2I 225 - 38 × 300 132 MC	6 156
	5,77	11673	1,6	MR C2I 225 - 42 × 350 160 M	6 156
	5,76	11686	2,36	MR C2I 250 - 42 × 350 160 M	6 156
	5,85	11509	3,15	MR C2I 280 - 42 × 350 160 M	6 154

1) Powers valid for continuous duty S1; **increase possible** for duty cycles S2 ... S10 (see ch. 1 «General specifications»); in which case M_2 increases and f_s decreases.

2) For complete designation when ordering see ch. 2.

13 - Selection tables (bevel helical gearmotors)

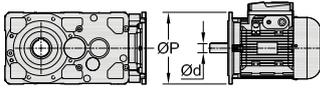

P_1 kW	n_2 min ⁻¹	M_2 N m	f_s		i
1)				2)	
7,5	6,93	9711	0,95	MR C2I 180 - 38 × 300 132 MC	6 130
	6,93	9711	0,95	MR C2I 180 - 42 × 350 160 M	6 130
	7,7	8747	1,06	MR ICI 200 - 38 × 300 132 MC	6 117
	7,08	9514	1,6	MR C2I 200 - 38 × 300 132 MC	6 127
	7,08	9514	1,6	MR C2I 200 - 42 × 350 160 M	6 127
	7,18	9372	1,9	MR C2I 225 - 38 × 300 132 MC	6 125
	7,18	9372	1,9	MR C2I 225 - 42 × 350 160 M	6 125
	7,31	9207	3,35	MR C2I 250 - 42 × 350 160 M	6 123
	8,83	7622	1,18	MR C2I 180 - 38 × 300 132 M	4 158
	8,67	7769	1,25	MR C2I 180 - 38 × 300 132 MC	6 104
	8,67	7769	1,25	MR C2I 180 - 42 × 350 160 M	6 104
	9,62	6997	1,6	MR ICI 200 - 38 × 300 132 MC	6 93,5
	9,22	7306	1,32	MR ICI 200 - 42 × 350 160 M	6 97,7
	9,24	7285	1,7	MR C2I 200 - 38 × 300 132 M	4 151
	8,97	7504	2,36	MR C2I 225 - 38 × 300 132 M	4 156
	9,96	6762	1,18	MR C2I 160 - 38 × 300 132 MC	6 90,4
	9,96	6762	1,18	MR C2I 160 - 42 × 350 160 M	6 90,4
	10,8	6212	1,18	MR C2I 160 - 38 × 300 132 M	4 129
	10,8	6243	1,5	MR C2I 180 - 38 × 300 132 M	4 130
	12	5623	1,7	MR ICI 200 - 38 × 300 132 M	4 117
	11,5	5845	1,9	MR ICI 200 - 38 × 300 132 MC	6 78,1
	11,5	5845	1,9	MR ICI 200 - 42 × 350 160 M	6 78,1
	11	6116	2,36	MR C2I 200 - 38 × 300 132 M	4 127
	12,8	5252	0,85	MR C2I 140 - 38 × 300 132 MC	6 70,2
	14,3	4723	0,9	MR C2I 140 - 38 × 300 132 M	4 98,2
	14,2	4735	1,18	MR ICI 160 - 28 × 250 132 M *	4 98,5
	14,3	4706	1,18	MR ICI 160 - 38 × 300 132 MC	6 62,9
	14,3	4706	1,18	MR ICI 160 - 42 × 350 160 M	6 62,9
	13,5	4969	1,4	MR C2I 160 - 38 × 300 132 M	4 103
	13,8	4878	1,25	MR ICI 180 - 28 × 250 132 M *	4 101
	13,9	4848	1,25	MR ICI 180 - 38 × 300 132 MC	6 64,8
	13,9	4848	1,25	MR ICI 180 - 42 × 350 160 M	6 64,8
	13,5	4994	1,9	MR C2I 180 - 38 × 300 132 M	4 104
	15	4498	2,5	MR ICI 200 - 38 × 300 132 M	4 93,5
	13,8	4893	2,8	MR C2I 200 - 38 × 300 132 M	4 102
	16	4220	1	MR C2I 140 - 38 × 300 132 M	4 87,8
	15,5	4347	1,8	MR C2I 160 - 38 × 300 132 M	4 90,4
	15,6	4328	1,9	MR C2I 180 - 38 × 300 132 M	4 90
	15,9	4228	3,55	MR C2I 200 - 38 × 300 132 M	4 87,9
	17,9	3757	0,8	MR ICI 140 - 28 × 250 132 M *	4 78,1
	17,7	3797	0,8	MR ICI 140 - 38 × 300 132 MC	6 50,8
	17,8	3779	1,25	MR C2I 140 - 38 × 300 132 M	4 78,6
	17,9	3757	1,5	MR ICI 160 - 28 × 250 132 M *	4 78,1
	17,8	3782	1,18	MR ICI 160 - 38 × 300 132 M	4 78,6
	17,9	3765	1,5	MR ICI 160 - 38 × 300 132 MC	6 50,3
	18,3	3683	1,5	MR ICI 160 - 42 × 350 160 M	6 49,2
	16,9	3976	1,8	MR C2I 160 - 38 × 300 132 M	4 82,7
	17,4	3870	1,5	MR ICI 180 - 28 × 250 132 M *	4 80,5
	17,4	3878	1,9	MR ICI 180 - 38 × 300 132 MC	6 51,8
	17,7	3794	1,6	MR ICI 180 - 42 × 350 160 M	6 50,7
16,9	3995	2,36	MR C2I 180 - 38 × 300 132 M	4 83,1	
17,9	3757	3	MR ICI 200 - 38 × 300 132 M	4 78,1	
19,9	3376	1,25	MR C2I 140 - 38 × 300 132 M	4 70,2	
19,4	3477	2,12	MR C2I 160 - 38 × 300 132 M	4 72,3	
19,4	3463	2,36	MR C2I 180 - 38 × 300 132 M	4 72	
22,1	3049	0,85	MR ICI 125 - 28 × 250 132 M *	4 63,4	
22,2	3038	0,85	MR ICI 125 - 38 × 300 132 MC	6 40,6	
22,1	3049	0,95	MR ICI 140 - 28 × 250 132 M *	4 63,4	
22,2	3038	1,18	MR ICI 140 - 38 × 300 132 MC	6 40,6	
22,6	2979	1,5	MR C2I 140 - 38 × 300 132 M	4 62	
22,3	3025	1,8	MR ICI 160 - 38 × 300 132 M	4 62,9	
21,5	3135	2,24	MR C2I 160 - 38 × 300 132 M	4 65,2	
21,7	3096	2,36	MR ICI 180 - 28 × 250 132 M *	4 64,4	
21,6	3116	1,9	MR ICI 180 - 38 × 300 132 M	4 64,8	
22,4	3006	4	MR ICI 200 - 38 × 300 132 M	4 62,5	
25,3	2662	1,6	MR C2I 140 - 38 × 300 132 M	4 55,4	
24,6	2742	2,8	MR C2I 160 - 38 × 300 132 M	4 57	

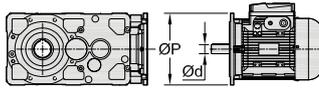
P_1 kW	n_2 min ⁻¹	M_2 N m	f_s		i	
1)				2)		
7,5	27,6	2441	1,06	MR ICI 125 - 38 × 300 132 M	4 50,8	
	27,7	2430	1,18	MR ICI 125 - 38 × 300 132 MC	6 32,5	
	27,6	2439	1,5	MR ICI 140 - 28 × 250 132 M *	4 50,7	
	27,6	2441	1,18	MR ICI 140 - 38 × 300 132 M	4 50,8	
	28,1	2395	1,5	MR ICI 140 - 38 × 300 132 MC	6 32	
	27,8	2426	1,7	MR C2I 140 - 38 × 300 132 M	4 50,4	
	27,8	2420	2,36	MR ICI 160 - 38 × 300 132 M	4 50,3	
	26,8	2508	2,8	MR C2I 160 - 38 × 300 132 M	4 52,1	
	29,3	2351	1,7	MR CI 160 - 42 × 350 160 M	6 30,8	
	31,1	2168	2	MR C2I 140 - 38 × 300 132 M	4 45,1	
	34,5	1953	1,32	MR ICI 125 - 38 × 300 132 M	4 40,6	
	35,1	1916	1,5	MR ICI 125 - 38 × 300 132 MC	6 25,6	
	36	1910	1,32	MR CI 125 - 38 × 300 132 MC	6 25	
	36	1910	1,32	MR CI 125 - 42 × 350 160 M	6 25	
	34,5	1953	1,8	MR ICI 140 - 38 × 300 132 M	4 40,6	
	36,2	1859	2,24	MR C2I 140 - 38 × 300 132 M	4 38,7	
	33,1	2032	3	MR ICI 160 - 38 × 300 132 M	4 42,3	
	36,6	1881	2,65	MR CI 160 - 42 × 350 160 M	6 24,6	
	37,3	1805	2,36	MR C2I 140 - 38 × 300 132 M	4 37,5	
	46,7	1472	0,9	MR CI 100 - 38 × 300 132 MC	6 19,3	
	43,1	1562	1,8	MR ICI 125 - 38 × 300 132 M	4 32,5	
	44,8	1535	1,32	MR CI 125 - 38 × 300 132 M	4 31,3	
	45	1528	1,7	MR CI 125 - 38 × 300 132 MC	6 20	
	45	1528	1,7	MR CI 125 - 42 × 350 160 M	6 20	
	43,7	1540	2,24	MR ICI 140 - 38 × 300 132 M	4 32	
	43,5	1548	2,36	MR C2I 140 - 38 × 300 132 M	4 32,2	
	45	1528	2,36	MR CI 140 - 38 × 300 132 MC	6 20	
	45	1528	2,36	MR CI 140 - 42 × 350 160 M	6 20	
	45,7	1504	3,75	MR CI 160 - 42 × 350 160 M	6 19,7	
	47,1	1431	3	MR C2I 140 - 38 × 300 132 M	4 29,8	
	50	1375	2,5	MR CI 140 - 38 × 300 132 MC	6 18	
	50	1375	2,5	MR CI 140 - 42 × 350 160 M	6 18	
		58,1	1183	0,9	MR CI 100 - 38 × 300 132 M	4 24,1
	54,7	1232	2,24	MR ICI 125 - 38 × 300 132 M	4 25,6	
	56	1228	2	MR CI 125 - 38 × 300 132 M	4 25	
	54,9	1227	3,15	MR C2I 140 - 38 × 300 132 M	4 25,5	
	72,6	947	1,4	MR CI 100 - 38 × 300 132 M	4 19,3	
	66,5	1012	2,65	MR ICI 125 - 38 × 300 132 M	4 21	
	70	982	2,65	MR CI 125 - 38 × 300 132 M	4 20	
	89,2	771	1,4	MR CI 100 - 38 × 300 132 M	4 15,7	
	87,5	786	3,15	MR CI 125 - 38 × 300 132 M	4 16	
	113	608	2,12	MR CI 100 - 38 × 300 132 M	4 12,4	
	111	620	4,25	MR CI 125 - 38 × 300 132 M	4 12,6	
		136	506	2,12	MR CI 100 - 38 × 300 132 M	4 10,3
	135	509	4,5	MR CI 125 - 38 × 300 132 M	4 10,4	
	174	396	2,12	MR CI 100 - 38 × 300 132 M	4 8,06	
	175	392	4,5	MR CI 125 - 38 × 300 132 M	4 7,98	
	217	317	2,12	MR CI 100 - 38 × 300 132 M	4 6,46	
	222	310	4,5	MR CI 125 - 38 × 300 132 M	4 6,31	
	9,2	9,24	8936	1,4	MR C2I 200 - 38 × 300 132 MB	4 151
8,97		9205	2	MR C2I 225 - 38 × 300 132 MB	4 156	
10,8		7658	1,18	MR C2I 180 - 38 × 300 132 MB	4 130	
12		6897	1,32	MR ICI 200 - 38 × 300 132 MB	4 117	
11		7503	2	MR C2I 200 - 38 × 300 132 MB	4 127	
11,2		7390	2,36	MR C2I 225 - 38 × 300 132 MB	4 125	
13,5		6096	1,18	MR C2I 160 - 38 × 300 132 MB	4 103	
13,5		6126	1,6	MR C2I 180 - 38 × 300 132 MB	4 104	
15		5518	2	MR ICI 200 - 38 × 300 132 MB	4 93,5	
13,8		6002	2,36	MR C2I 200 - 38 × 300 132 MB	4 102	
16		5177	0,85	MR C2I 140 - 38 × 300 132 MB	4 87,8	
15,5		5332	1,5	MR C2I 160 - 38 × 300 132 MB	4 90,4	
15,6		5309	1,6	MR C2I 180 - 38 × 300 132 MB	4 90	
15,9		5186	2,8	MR C2I 200 - 38 × 300 132 MB	4 87,9	

1) Powers valid for continuous duty S1; **increase possible** for duty cycles S2 ... S10 (see ch. 1 «General specifications»); in which case M_2 increases and f_s decreases.

2) For complete designation when ordering see ch. 2.

* Mounting position **B5R** (see ch. 1.2).

13 - Selection tables (bevel helical gearmotors)

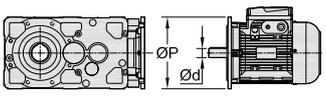

P_1 kW	n_2 min ⁻¹	M_2 N m	f_s		i	
1)				2)		
9,2	17,8	4635	1	MR C2I 140 - 38 × 300 132 MB	4 78,6	
	17,8	4639	1	MR ICI 160 - 38 × 300 132 MB	4 78,6	
	16,9	4877	1,4	MR C2I 160 - 38 × 300 132 MB	4 82,7	
	16,9	4901	1,9	MR C2I 180 - 38 × 300 132 MB	4 83,1	
	17,9	4609	2,36	MR ICI 200 - 38 × 300 132 MB	4 78,1	
	17,2	4802	2,8	MR C2I 200 - 38 × 300 132 MB	4 81,4	
	19,9	4142	1,06	MR C2I 140 - 38 × 300 132 MB	4 70,2	
	19,4	4266	1,8	MR C2I 160 - 38 × 300 132 MB	4 72,3	
	19,4	4247	2	MR C2I 180 - 38 × 300 132 MB	4 72	
	22,6	3655	1,18	MR C2I 140 - 38 × 300 132 MB	4 62	
	22,3	3711	1,5	MR ICI 160 - 38 × 300 132 MB	4 62,9	
	21,5	3845	1,8	MR C2I 160 - 38 × 300 132 MB	4 65,2	
	21,6	3823	1,5	MR ICI 180 - 38 × 300 132 MB	4 64,8	
	21,4	3864	2,36	MR C2I 180 - 38 × 300 132 MB	4 65,5	
	22,4	3687	3,15	MR ICI 200 - 38 × 300 132 MB	4 62,5	
	25,3	3266	1,32	MR C2I 140 - 38 × 300 132 MB	4 55,4	
	24,6	3363	2,24	MR C2I 160 - 38 × 300 132 MB	4 57	
	24,7	3349	2,5	MR C2I 180 - 38 × 300 132 MB	4 56,8	
	27,6	2994	0,85	MR ICI 125 - 38 × 300 132 MB	4 50,8	
	27,6	2994	0,95	MR ICI 140 - 38 × 300 132 MB	4 50,8	
	27,8	2976	1,4	MR C2I 140 - 38 × 300 132 MB	4 50,4	
	27,8	2969	1,9	MR ICI 160 - 38 × 300 132 MB	4 50,3	
	26,8	3076	2,24	MR C2I 160 - 38 × 300 132 MB	4 52,1	
	27	3058	2,36	MR ICI 180 - 38 × 300 132 MB	4 51,8	
	31,1	2659	1,6	MR C2I 140 - 38 × 300 132 MB	4 45,1	
	30,7	2691	2,8	MR C2I 160 - 38 × 300 132 MB	4 45,6	
	34,5	2395	1,06	MR ICI 125 - 38 × 300 132 MB	4 40,6	
	34,5	2395	1,5	MR ICI 140 - 38 × 300 132 MB	4 40,6	
	36,2	2281	1,8	MR C2I 140 - 38 × 300 132 MB	4 38,7	
	33,1	2493	2,36	MR ICI 160 - 38 × 300 132 MB	4 42,3	
	35,4	2332	3,15	MR C2I 160 - 38 × 300 132 MB	4 39,5	
	37,3	2214	1,9	MR C2I 140 - 38 × 300 132 MB	4 37,5	
	37,4	2210	3,15	MR C2I 160 - 38 × 300 132 MB	4 37,5	
	43,1	1916	1,5	MR ICI 125 - 38 × 300 132 MB	4 32,5	
	44,8	1883	1,06	MR CI 125 - 38 × 300 132 MB	4 31,3	
	43,7	1889	1,9	MR ICI 140 - 38 × 300 132 MB	4 32	
	43,5	1899	1,9	MR C2I 140 - 38 × 300 132 MB	4 32,2	
	42	1965	3,35	MR ICI 160 - 38 × 300 132 MB	4 33,3	
	43,1	1915	3,35	MR C2I 160 - 38 × 300 132 MB	4 32,5	
	47,1	1755	2,36	MR C2I 140 - 38 × 300 132 MB	4 29,8	
	54,7	1511	1,8	MR ICI 125 - 38 × 300 132 MB	4 25,6	
	56	1506	1,6	MR CI 125 - 38 × 300 132 MB	4 25	
	53,6	1540	2,24	MR ICI 140 - 38 × 300 132 MB	4 26,1	
	54,9	1506	2,65	MR C2I 140 - 38 × 300 132 MB	4 25,5	
	72,6	1161	1,12	MR CI 100 - 38 × 300 132 MB	4 19,3	
	66,5	1241	2,24	MR ICI 125 - 38 × 300 132 MB	4 21	
	70	1205	2,12	MR CI 125 - 38 × 300 132 MB	4 20	
	70	1205	2,8	MR CI 140 - 38 × 300 132 MB	4 20	
	77,8	1084	3,15	MR CI 140 - 38 × 300 132 MB	4 18	
	89,2	945	1,18	MR CI 100 - 38 × 300 132 MB	4 15,7	
87,5	964	2,65	MR CI 125 - 38 × 300 132 MB	4 16		
113	745	1,7	MR CI 100 - 38 × 300 132 MB	4 12,4		
111	760	3,55	MR CI 125 - 38 × 300 132 MB	4 12,6		
136	621	1,7	MR CI 100 - 38 × 300 132 MB	4 10,3		
135	624	3,75	MR CI 125 - 38 × 300 132 MB	4 10,4		
174	486	1,7	MR CI 100 - 38 × 300 132 MB	4 8,06		
175	481	3,75	MR CI 125 - 38 × 300 132 MB	4 7,98		
217	389	1,7	MR CI 100 - 38 × 300 132 MB	4 6,46		
222	380	3,75	MR CI 125 - 38 × 300 132 MB	4 6,31		
11	5,77	17121	1,12	MR C2I 225 - 42 × 350 160 L	6 156	
	5,76	17140	1,6	MR C2I 250 - 42 × 350 160 L	6 156	
	5,85	16880	2,24	MR C2I 280 - 42 × 350 160 L	6 154	
	7,08	13954	1,12	MR C2I 200 - 42 × 350 160 L	6 127	
	7,18	13745	1,32	MR C2I 225 - 42 × 350 160 L	6 125	
	7,31	13504	2,36	MR C2I 250 - 42 × 350 160 L	6 123	
	7,17	13764	2,65	MR C2I 280 - 42 × 350 160 L	6 125	
	11	9,24	10684	1,18	MR C2I 200 - 38 × 300 132 MC	4 151
		9,24	10684	1,18	MR C2I 200 - 42 × 350 160 M	4 151
		8,85	11163	1,32	MR C2I 200 - 42 × 350 160 L	6 102
8,97		11006	1,6	MR C2I 225 - 38 × 300 132 MC	4 156	
8,97		11006	1,6	MR C2I 225 - 42 × 350 160 M	4 156	
8,98		10996	1,7	MR C2I 225 - 42 × 350 160 L	6 100	
8,96		11018	2,36	MR C2I 250 - 42 × 350 160 M	4 156	
9,1		10851	3,15	MR C2I 280 - 42 × 350 160 M	4 154	
10		9875	0,85	MR C2I 180 - 42 × 350 160 L	6 90	
10,8		9156	1	MR C2I 180 - 38 × 300 132 MC	4 130	
10,8	9156	1	MR C2I 180 - 42 × 350 160 M	4 130		
10,8	9115	1,06	MR C2I 180 - 42 × 350 160 L	6 83,1		
12	8247	1,12	MR ICI 200 - 38 × 300 132 MC	4 117		
11,5	8572	1,32	MR ICI 200 - 42 × 350 160 L	6 78,1		
11	8970	1,6	MR C2I 200 - 38 × 300 132 MC	4 127		
11	8970	1,6	MR C2I 200 - 42 × 350 160 M	4 127		
11,2	8836	2	MR C2I 225 - 38 × 300 132 MC	4 125		
11,2	8836	2	MR C2I 225 - 42 × 350 160 M	4 125		
11,4	8681	3,35	MR C2I 250 - 42 × 350 160 M	4 123		
13,5	7288	1	MR C2I 160 - 38 × 300 132 MC	4 103		
13,5	7288	1	MR C2I 160 - 42 × 350 160 M	4 103		
13,9	7110	0,85	MR ICI 180 - 42 × 350 160 L	6 64,8		
13,5	7325	1,32	MR C2I 180 - 38 × 300 132 MC	4 104		
13,5	7325	1,32	MR C2I 180 - 42 × 350 160 M	4 104		
15	6598	1,7	MR ICI 200 - 38 × 300 132 MC	4 93,5		
14,3	6888	1,32	MR ICI 200 - 42 × 350 160 M	4 97,7		
14,3	6902	1,6	MR ICI 200 - 42 × 350 160 L	6 62,9		
13,8	7176	2	MR C2I 200 - 38 × 300 132 MC	4 102		
13,8	7176	2	MR C2I 200 - 42 × 350 160 M	4 102		
14	7069	2,65	MR C2I 225 - 42 × 350 160 M	4 100		
15,5	6375	1,18	MR C2I 160 - 38 × 300 132 MC	4 90,4		
15,5	6375	1,18	MR C2I 160 - 42 × 350 160 M	4 90,4		
15,6	6348	1,32	MR C2I 180 - 38 × 300 132 MC	4 90		
15,6	6348	1,32	MR C2I 180 - 42 × 350 160 M	4 90		
15,9	6201	2,36	MR C2I 200 - 42 × 350 160 M	4 87,9		
18,3	5402	1	MR ICI 160 - 42 × 350 160 L	6 49,2		
16,9	5831	1,18	MR C2I 160 - 38 × 300 132 MC	4 82,7		
16,9	5831	1,18	MR C2I 160 - 42 × 350 160 M	4 82,7		
16,9	5860	1,6	MR C2I 180 - 38 × 300 132 MC	4 83,1		
16,9	5860	1,6	MR C2I 180 - 42 × 350 160 M	4 83,1		
17,9	5511	2	MR ICI 200 - 38 × 300 132 MC	4 78,1		
17,9	5511	2	MR ICI 200 - 42 × 350 160 M	4 78,1		
17,2	5741	2,36	MR C2I 200 - 42 × 350 160 M	4 81,4		
19,9	4952	0,85	MR C2I 140 - 38 × 300 132 MC	4 70,2		
19,4	5100	1,5	MR C2I 160 - 38 × 300 132 MC	4 72,3		
19,4	5100	1,5	MR C2I 160 - 42 × 350 160 M	4 72,3		
19,4	5078	1,6	MR C2I 180 - 38 × 300 132 MC	4 72		
19,4	5078	1,6	MR C2I 180 - 42 × 350 160 M	4 72		
19,9	4961	3	MR C2I 200 - 42 × 350 160 M	4 70,3		
22,6	4370	1	MR C2I 140 - 38 × 300 132 MC	4 62		
22,3	4437	1,25	MR ICI 160 - 38 × 300 132 MC	4 62,9		
22,3	4437	1,25	MR ICI 160 - 42 × 350 160 M	4 62,9		
22,9	4321	1,32	MR ICI 160 - 42 × 350 160 L	6 39,4		
21,5	4597	1,5	MR C2I 160 - 38 × 300 132 MC	4 65,2		
21,5	4597	1,5	MR C2I 160 - 42 × 350 160 M	4 65,2		
21,6	4571	1,32	MR ICI 180 - 38 × 300 132 MC	4 64,8		
21,6	4571	1,32	MR ICI 180 - 42 × 350 160 M	4 64,8		
22,2	4451	1,7	MR ICI 180 - 42 × 350 160 L	6 40,6		
21,4	4620	2	MR C2I 180 - 38 × 300 132 MC	4 65,5		
21,4	4620	2	MR C2I 180 - 42 × 350 160 M	4 65,5		
22,3	4437	2,5	MR ICI 200 - 42 × 350 160 M	4 62,9		
25,3	3904	1,06	MR C2I 140 - 38 × 300 132 MC	4 55,4		
24,6	4021	1,9	MR C2I 160 - 38 × 300 132 MC	4 57		
24,6	4021	1,9	MR C2I 160 - 42 × 350 160 M	4 57		
24,7	4004	2	MR C2I 180 - 42 × 350 160 M	4 56,8		

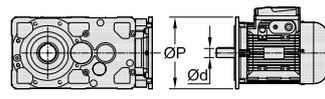
P_1 kW	n_2 min ⁻¹	M_2 N m	f_s		i
1)				2)	
11	9,24	10684	1,18	MR C2I 200 - 38 × 300 132 MC	4 151
	9,24	10684	1,18	MR C2I 200 - 42 × 350 160 M	4 151
	8,85	11163	1,32	MR C2I 200 - 42 × 350 160 L	6 102
	8,97	11006	1,6	MR C2I 225 - 38 × 300 132 MC	4 156
	8,97	11006	1,6	MR C2I 225 - 42 × 350 160 M	4 156
	8,98	10996	1,7	MR C2I 225 - 42 × 350 160 L	6 100
	8,96	11018	2,36	MR C2I 250 - 42 × 350 160 M	4 156
	9,1	10851	3,15	MR C2I 280 - 42 × 350 160 M	4 154
	10	9875	0,85	MR C2I 180 - 42 × 350 160 L	6 90
	10,8	9156	1	MR C2I 180 - 38 × 300 132 MC	4 130
	10,8	9156	1	MR C2I 180 - 42 × 350 160 M	4 130
	10,8	9115	1,06	MR C2I 180 - 42 × 350 160 L	6 83,1
	12	8247	1,12	MR ICI 200 - 38 × 300 132 MC	4 117
	11,5	8572	1,32	MR ICI 200 - 42 × 350 160 L	6 78,1
	11	8970	1,6	MR C2I 200 - 38 × 300 132 MC	4 127
	11	8970	1,6	MR C2I 200 - 42 × 350 160 M	4 127
	11,2	8836	2	MR C2I 225 - 38 × 300 132 MC	4 125
	11,2	8836	2	MR C2I 225 - 42 × 350 160 M	4 125
	11,4	8681	3,35	MR C2I 250 - 42 × 350 160 M	4 123
	13,5	7288	1	MR C2I 160 - 38 × 300 132 MC	4 103
	13,5	7288	1	MR C2I 160 - 42 × 350 160 M	4 103
	13,9	7110	0,85	MR ICI 180 - 42 × 350 160 L	6 64,8
	13,5	7325			

13 - Selection tables (bevel helical gearmotors)

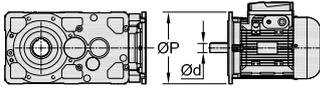

P_1 kW	n_2 min ⁻¹	M_2 N m	f_s		i
1)				2)	
11	27,6	3580	0,8	MR ICI 140 - 38 × 300	132 MC 4 50,8
	27,8	3558	1,18	MR C2I 140 - 38 × 300	132 MC 4 50,4
	27,8	3550	1,6	MR ICI 160 - 38 × 300	132 MC 4 50,3
	28,4	3472	1,6	MR ICI 160 - 42 × 350	160 M 4 49,2
	26,8	3678	1,9	MR C2I 160 - 38 × 300	132 MC 4 52,1
	26,8	3678	1,9	MR C2I 160 - 42 × 350	160 M 4 52,1
	29,3	3448	1,18	MR CI 160 - 42 × 350	160 L 6 30,8
	27	3657	2	MR ICI 180 - 38 × 300	132 MC 4 51,8
	28,1	3510	2,36	MR ICI 180 - 42 × 350	160 L 6 32
	26,7	3696	2,5	MR C2I 180 - 42 × 350	160 M 4 52,4
	27,8	3550	3,35	MR ICI 200 - 42 × 350	160 M 4 50,3
	31,1	3179	1,32	MR C2I 140 - 38 × 300	132 MC 4 45,1
	30,7	3217	2,36	MR C2I 160 - 38 × 300	132 MC 4 45,6
	30,7	3217	2,36	MR C2I 160 - 42 × 350	160 M 4 45,6
	30,8	3203	2,8	MR C2I 180 - 42 × 350	160 M 4 45,4
	34,5	2864	0,9	MR ICI 125 - 38 × 300	132 MC 4 40,6
	36	2801	0,9	MR CI 125 - 42 × 350	160 L 6 25
	34,5	2864	1,25	MR ICI 140 - 38 × 300	132 MC 4 40,6
	36,2	2727	1,5	MR C2I 140 - 38 × 300	132 MC 4 38,7
	33,1	2980	2	MR ICI 160 - 38 × 300	132 MC 4 42,3
	35,5	2778	2	MR ICI 160 - 42 × 350	160 M 4 39,4
	35,4	2788	2,65	MR C2I 160 - 42 × 350	160 M 4 39,5
	36,6	2758	1,8	MR CI 160 - 42 × 350	160 L 6 24,6
	34,3	2883	2,8	MR ICI 180 - 38 × 300	132 MC 4 40,9
	34,5	2862	2,5	MR ICI 180 - 42 × 350	160 M 4 40,6
	34,1	2892	3	MR C2I 180 - 42 × 350	160 M 4 41
	37,3	2647	1,6	MR C2I 140 - 38 × 300	132 MC 4 37,5
	37,4	2643	2,65	MR C2I 160 - 42 × 350	160 M 4 37,5
	43,1	2291	1,25	MR ICI 125 - 38 × 300	132 MC 4 32,5
	45	2241	1,18	MR CI 125 - 42 × 350	160 L 6 20
	43,7	2258	1,6	MR ICI 140 - 38 × 300	132 MC 4 32
	43,5	2271	1,6	MR C2I 140 - 38 × 300	132 MC 4 32,2
	45	2241	1,6	MR CI 140 - 42 × 350	160 L 6 20
	42,3	2332	2,5	MR ICI 160 - 42 × 350	160 M 4 33,1
	43,1	2290	2,8	MR C2I 160 - 42 × 350	160 M 4 32,5
	45,5	2216	1,8	MR CI 160 - 42 × 350	160 M 4 30,8
	45,7	2207	2,5	MR CI 160 - 42 × 350	160 L 6 19,7
	47,1	2098	2	MR C2I 140 - 38 × 300	132 MC 4 29,8
	50	2017	1,7	MR CI 140 - 42 × 350	160 L 6 18
	47,1	2095	3,35	MR C2I 160 - 42 × 350	160 M 4 29,7
	54,7	1807	1,5	MR ICI 125 - 38 × 300	132 MC 4 25,6
	56	1801	1,4	MR CI 125 - 38 × 300	132 MC 4 25
	56	1801	1,4	MR CI 125 - 42 × 350	160 M 4 25
	53,6	1841	1,8	MR ICI 140 - 38 × 300	132 MC 4 26,1
	54,9	1800	2,12	MR C2I 140 - 38 × 300	132 MC 4 25,5
	57,1	1767	2	MR CI 140 - 42 × 350	160 L 6 15,8
	53,7	1839	3,75	MR ICI 160 - 42 × 350	160 M 4 26,1
	54,4	1815	3,55	MR C2I 160 - 42 × 350	160 M 4 25,7
	56,9	1773	2,65	MR CI 160 - 42 × 350	160 M 4 24,6
	63,4	1590	2,36	MR CI 140 - 42 × 350	160 L 6 14,2
72,6	1388	0,95	MR CI 100 - 38 × 300	132 MC 4 19,3	
66,5	1484	1,8	MR ICI 125 - 38 × 300	132 MC 4 21	
70	1441	1,8	MR CI 125 - 38 × 300	132 MC 4 20	
70	1441	1,8	MR CI 125 - 42 × 350	160 M 4 20	
70	1441	2,36	MR CI 140 - 38 × 300	132 MC 4 20	
70	1441	2,36	MR CI 140 - 42 × 350	160 M 4 20	
70,8	1394	3,75	MR ICI 160 - 42 × 350	160 M 4 19,8	
77,8	1297	2,65	MR CI 140 - 42 × 350	160 M 4 18	
89,2	1130	1	MR CI 100 - 38 × 300	132 MC 4 15,7	
87,5	1153	2,12	MR CI 125 - 38 × 300	132 MC 4 16	
87,5	1153	2,12	MR CI 125 - 42 × 350	160 M 4 16	
113	891	1,4	MR CI 100 - 38 × 300	132 MC 4 12,4	
111	909	3	MR CI 125 - 38 × 300	132 MC 4 12,6	
111	909	3	MR CI 125 - 42 × 350	160 M 4 12,6	
136	742	1,4	MR CI 100 - 38 × 300	132 MC 4 10,3	
135	746	3	MR CI 125 - 38 × 300	132 MC 4 10,4	
135	746	3	MR CI 125 - 42 × 350	160 M 4 10,4	

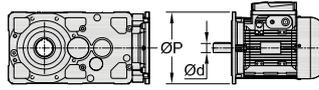
P_1 kW	n_2 min ⁻¹	M_2 N m	f_s		i	
1)				2)		
11	174	581	1,4	MR CI 100 - 38 × 300	132 MC 4 8,06	
	175	575	3	MR CI 125 - 38 × 300	132 MC 4 7,98	
	175	575	3	MR CI 125 - 42 × 350	160 M 4 7,98	
	217	465	1,4	MR CI 100 - 38 × 300	132 MC 4 6,46	
	222	454	3	MR CI 125 - 38 × 300	132 MC 4 6,31	
	222	454	3	MR CI 125 - 42 × 350	160 M 4 6,31	
	15	5,76	23372	1,18	MR C2I 250 - 48 × 350	180 L 6 156
		5,85	23018	1,6	MR C2I 280 - 48 × 350	180 L 6 154
		7,18	18743	0,95	MR C2I 225 - 48 × 350	180 L 6 125
		7,31	18414	1,7	MR CI 250 - 48 × 350	180 L 6 123
7,17		18768	1,9	MR C2I 280 - 48 × 350	180 L 6 125	
8,97		15009	1,18	MR C2I 225 - 42 × 350	160 L 4 156	
8,98		14995	1,25	MR C2I 225 - 48 × 350	180 L 6 100	
8,96		15025	1,7	MR C2I 250 - 42 × 350	160 L 4 156	
9,1		14797	2,36	MR C2I 280 - 42 × 350	160 L 4 154	
10,2		13153	1,18	MR C2I 200 - 48 × 350	180 L 6 87,9	
11		12232	1,18	MR C2I 200 - 42 × 350	160 L 4 127	
11,2		12049	1,5	MR C2I 225 - 42 × 350	160 L 4 125	
11,4		11838	2,5	MR C2I 250 - 42 × 350	160 L 4 123	
13,5		9988	0,95	MR C2I 180 - 42 × 350	160 L 4 104	
15		8997	1,25	MR ICI 200 - 38 × 300	160 L * 4 93,5	
14,3		9393	1	MR ICI 200 - 42 × 350	160 L 4 97,7	
14,3		9412	1,18	MR ICI 200 - 48 × 350	180 L 6 62,9	
13,8		9786	1,4	MR C2I 200 - 42 × 350	160 L 4 102	
14		9639	2	MR C2I 225 - 42 × 350	160 L 4 100	
14,2		9470	3	MR C2I 250 - 42 × 350	160 L 4 98,5	
15,6		8656	0,95	MR C2I 180 - 42 × 350	160 L 4 90	
15,9		8456	1,8	MR C2I 200 - 42 × 350	160 L 4 87,9	
15,5		8681	2,24	MR C2I 225 - 42 × 350	160 L 4 90,3	
16,9		7991	1,18	MR C2I 180 - 42 × 350	160 L 4 83,1	
17,9		7514	1,5	MR ICI 200 - 42 × 350	160 L 4 78,1	
17,2		7829	1,8	MR C2I 200 - 42 × 350	160 L 4 81,4	
17,5		7711	2,5	MR C2I 225 - 42 × 350	160 L 4 80,2	
19,4		6955	1,06	MR C2I 160 - 42 × 350	160 L 4 72,3	
19,4		6925	1,18	MR C2I 180 - 42 × 350	160 L 4 72	
19,9		6764	2,12	MR C2I 200 - 42 × 350	160 L 4 70,3	
19,4	6945	2,65	MR C2I 225 - 42 × 350	160 L 4 72,2		
22,3	6050	0,9	MR ICI 160 - 42 × 350	160 L 4 62,9		
21,5	6269	1,12	MR C2I 160 - 42 × 350	160 L 4 65,2		
22,2	6070	1,25	MR ICI 180 - 48 × 350	180 L 6 40,6		
21,4	6300	1,5	MR C2I 180 - 42 × 350	160 L 4 65,5		
22,3	6050	1,8	MR ICI 200 - 42 × 350	160 L 4 62,9		
21,8	6173	2,24	MR C2I 200 - 42 × 350	160 L 4 64,2		
24,6	5484	1,4	MR C2I 160 - 42 × 350	160 L 4 57		
24,7	5460	1,5	MR C2I 180 - 42 × 350	160 L 4 56,8		
25,2	5334	2,8	MR C2I 200 - 42 × 350	160 L 4 55,5		
27,8	4852	0,85	MR C2I 140 - 38 × 300	160 L * 4 50,4		
28,4	4735	1,12	MR ICI 160 - 42 × 350	160 L 4 49,2		
26,8	5015	1,4	MR C2I 160 - 42 × 350	160 L 4 52,1		
28,1	4786	1,7	MR ICI 180 - 48 × 350	180 L 6 32		
26,7	5040	1,8	MR C2I 180 - 42 × 350	160 L 4 52,4		
27,8	4840	2,36	MR ICI 200 - 42 × 350	160 L 4 50,3		
26	5182	2,65	MR C2I 200 - 42 × 350	160 L 4 53,9		
29,3	4702	1,7	MR CI 200 - 48 × 350	180 L 6 30,8		
31,1	4335	1	MR C2I 140 - 38 × 300	160 L * 4 45,1		
30,7	4387	1,7	MR C2I 160 - 42 × 350	160 L 4 45,6		
30,8	4368	2,12	MR C2I 180 - 42 × 350	160 L 4 45,4		
34,5	3906	0,9	MR ICI 140 - 38 × 300	160 L * 4 40,6		
36,2	3719	1,12	MR C2I 140 - 38 × 300	160 L * 4 38,7		
35,5	3788	1,5	MR ICI 160 - 42 × 350	160 L 4 39,4		
35,4	3802	2	MR C2I 160 - 42 × 350	160 L 4 39,5		
36,6	3761	1,32	MR CI 160 - 48 × 350	180 L 6 24,6		
34,5	3902	1,9	MR CI 180 - 42 × 350	160 L 4 40,6		
34,1	3943	2,12	MR C2I 180 - 42 × 350	160 L 4 41		
33,1	4064	3	MR ICI 200 - 42 × 350	160 L 4 42,3		
36,6	3761	2,65	MR CI 200 - 48 × 350	180 L 6 24,6		

1) Powers valid for continuous duty S1; **increase possible** for duty cycles S2 ... S10 (see ch. 1 «General specifications»): in which case M_2 increases and f_s decreases.

2) For complete designation when ordering see ch. 2.

* Mounting position **B5R** (see ch. 1.2).

13 - Selection tables (bevel helical garmotors)

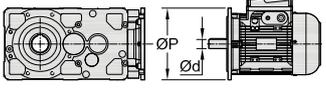

P_1 kW	n_2 min ⁻¹	M_2 N m	f_s		i	
1)				2)		
15	37,3	3610	1,18	MR C2I 140 - 38 × 300 160 L *	4 37,5	
	37,4	3603	2	MR C2I 160 - 42 × 350 160 L	4 37,5	
	37,5	3588	2,5	MR C2I 180 - 42 × 350 160 L	4 37,3	
	45	3056	0,85	MR CI 125 - 48 × 350 180 L	6 20	
	43,7	3079	1,12	MR ICI 140 - 38 × 300 160 L *	4 32	
	43,5	3097	1,18	MR C2I 140 - 38 × 300 160 L *	4 32,2	
	45	3056	1,18	MR CI 140 - 48 × 350 180 L	6 20	
	42,3	3180	1,9	MR ICI 160 - 42 × 350 160 L	4 33,1	
	43,1	3123	2	MR C2I 160 - 42 × 350 160 L	4 32,5	
	45,5	3022	1,32	MR CI 160 - 42 × 350 160 L	4 30,8	
	45,7	3009	1,9	MR CI 160 - 48 × 350 180 L	6 19,7	
	43,8	3077	2,65	MR ICI 180 - 42 × 350 160 L	4 32	
	41,6	3239	2,5	MR C2I 180 - 42 × 350 160 L	4 33,7	
	44,4	3100	2,24	MR CI 180 - 48 × 350 180 L	6 20,3	
	45,7	3009	3,75	MR CI 200 - 48 × 350 180 L	6 19,7	
	47,1	2861	1,5	MR C2I 140 - 38 × 300 160 L *	4 29,8	
	50	2750	1,25	MR CI 140 - 48 × 350 180 L	6 18	
	47,1	2856	2,5	MR C2I 160 - 42 × 350 160 L	4 29,7	
	56	2456	1	MR CI 125 - 42 × 350 160 L	4 25	
	53,6	2511	1,32	MR ICI 140 - 38 × 300 160 L *	4 26,1	
	54,9	2455	1,6	MR C2I 140 - 38 × 300 160 L *	4 25,5	
	57,1	2410	1,5	MR CI 140 - 48 × 350 180 L	6 15,8	
	53,7	2508	2,65	MR ICI 160 - 42 × 350 160 L	4 26,1	
	54,4	2476	2,5	MR C2I 160 - 42 × 350 160 L	4 25,7	
	56,9	2418	2	MR CI 160 - 42 × 350 160 L	4 24,6	
	63,4	2169	1,7	MR CI 140 - 48 × 350 180 L	6 14,2	
	70	1965	1,32	MR CI 125 - 42 × 350 160 L	4 20	
	70	1965	1,7	MR CI 140 - 42 × 350 160 L	4 20	
	70,8	1901	2,8	MR ICI 160 - 42 × 350 160 L	4 19,8	
	71,1	1934	2,8	MR CI 160 - 42 × 350 160 L	4 19,7	
	77,8	1768	1,9	MR CI 140 - 42 × 350 160 L	4 18	
	77,8	1768	3	MR CI 160 - 42 × 350 160 L	4 18	
	87,5	1572	1,6	MR CI 125 - 42 × 350 160 L	4 16	
	88,8	1549	2,12	MR CI 140 - 42 × 350 160 L	4 15,8	
	84,7	1624	3	MR CI 160 - 42 × 350 160 L	4 16,5	
	98,6	1394	2,5	MR CI 140 - 42 × 350 160 L	4 14,2	
	111	1239	2,12	MR CI 125 - 42 × 350 160 L	4 12,6	
	135	1018	2,24	MR CI 125 - 42 × 350 160 L	4 10,4	
	175	784	2,24	MR CI 125 - 42 × 350 160 L	4 7,98	
	222	620	2,24	MR CI 125 - 42 × 350 160 L	4 6,31	
	18,5	5,85	28389	1,32	MR C2I 280 - 55 × 400 200 LR	6 154
		5,76	28826	1,6	MR C2I 320 - 55 × 400 200 LR	6 156
		5,76	28826	2	MR C2I 321 - 55 × 400 200 LR	6 156
		5,59	29694	2,5	MR C2I 360 - 55 × 400 200 LR	6 161
		7,31	22711	1,4	MR C2I 250 - 55 × 400 200 LR	6 123
		7,17	23148	1,6	MR C2I 280 - 55 × 400 200 LR	6 125
		6,97	23811	2,24	MR C2I 320 - 55 × 400 200 LR	6 129
		6,97	23811	2,8	MR C2I 321 - 55 × 400 200 LR	6 129
8,98		18493	1,06	MR C2I 225 - 55 × 400 200 LR	6 100	
8,96		18531	1,4	MR C2I 250 - 48 × 350 180 M	4 156	
9,14		18169	1,7	MR C2I 250 - 55 × 400 200 LR	6 98,5	
9,1		18250	1,9	MR C2I 280 - 48 × 350 180 M	4 154	
8,97		18518	2,12	MR C2I 280 - 55 × 400 200 LR	6 100	
9,97		16655	1,18	MR C2I 225 - 55 × 400 200 LR	6 90,3	
10		16547	2,36	MR C2I 280 - 55 × 400 200 LR	6 89,7	
11		15087	0,95	MR C2I 200 - 48 × 350 180 M	4 127	
11,2		14861	1,18	MR C2I 225 - 48 × 350 180 M	4 125	
11,2		14795	1,4	MR C2I 225 - 55 × 400 200 LR	6 80,2	
11,4		14600	2	MR C2I 250 - 48 × 350 180 M	4 123	
11,2		14881	2,36	MR C2I 280 - 48 × 350 180 M	4 125	
14,3		11608	0,95	MR ICI 200 - 55 × 400 200 LR	6 62,9	
13,8		12069	1,18	MR C2I 200 - 48 × 350 180 M	4 102	
14		11889	1,6	MR C2I 225 - 48 × 350 180 M	4 100	
14,2		11680	2,5	MR C2I 250 - 48 × 350 180 M	4 98,5	

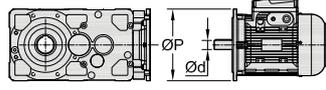
P_1 kW	n_2 min ⁻¹	M_2 N m	f_s		i
1)				2)	
18,5	15,9	10429	1,4	MR C2I 200 - 48 × 350 180 M	4 87,9
	15,5	10707	1,8	MR C2I 225 - 48 × 350 180 M	4 90,3
	15,7	10557	2,8	MR C2I 250 - 48 × 350 180 M	4 89
	16,9	9855	0,95	MR C2I 180 - 48 × 350 180 M	4 83,1
	17,8	9328	1	MR ICI 200 - 48 × 350 180 M	4 78,6
	18,3	9084	1,18	MR ICI 200 - 55 × 400 200 LR	6 49,2
	17,2	9655	1,4	MR C2I 200 - 48 × 350 180 M	4 81,4
	17,5	9511	2,12	MR C2I 225 - 48 × 350 180 M	4 80,2
	17,8	9344	3	MR C2I 250 - 48 × 350 180 M	4 78,8
	19,4	8541	0,95	MR C2I 180 - 48 × 350 180 M	4 72
	19,9	8343	1,8	MR C2I 200 - 48 × 350 180 M	4 70,3
	19,4	8565	2,12	MR C2I 225 - 48 × 350 180 M	4 72,2
	21,4	7770	1,18	MR C2I 180 - 48 × 350 180 M	4 65,5
	22,3	7462	1,5	MR ICI 200 - 48 × 350 180 M	4 62,9
	21,8	7613	1,8	MR C2I 200 - 48 × 350 180 M	4 64,2
	22,1	7499	2,65	MR C2I 225 - 48 × 350 180 M	4 63,2
	24,6	6763	1,12	MR C2I 160 - 48 × 350 180 M	4 57
	24,7	6734	1,18	MR C2I 180 - 48 × 350 180 M	4 56,8
	25,2	6578	2,24	MR C2I 200 - 48 × 350 180 M	4 55,5
	24,6	6753	2,65	MR C2I 225 - 48 × 350 180 M	4 56,9
	28,4	5840	0,95	MR ICI 160 - 48 × 350 180 M	4 49,2
	26,8	6186	1,12	MR C2I 160 - 48 × 350 180 M	4 52,1
	26,7	6216	1,5	MR C2I 180 - 48 × 350 180 M	4 52,4
	27,8	5970	1,9	MR ICI 200 - 48 × 350 180 M	4 50,3
	26	6392	2,12	MR C2I 200 - 48 × 350 180 M	4 53,9
	29,3	5799	1,4	MR CI 200 - 55 × 400 200 LR	6 30,8
	26,4	6296	2,8	MR C2I 225 - 48 × 350 180 M	4 53,1
	30,7	5410	1,4	MR C2I 160 - 48 × 350 180 M	4 45,6
	30,8	5387	1,7	MR C2I 180 - 48 × 350 180 M	4 45,4
	30,1	5523	2,65	MR C2I 200 - 48 × 350 180 M	4 46,6
	35,5	4672	1,25	MR ICI 160 - 48 × 350 180 M	4 39,4
	35,4	4689	1,6	MR C2I 160 - 48 × 350 180 M	4 39,5
	36,6	4639	1,06	MR CI 160 - 55 × 400 200 LR	6 24,6
	34,5	4813	1,5	MR ICI 180 - 48 × 350 180 M	4 40,6
	34,1	4864	1,7	MR C2I 180 - 48 × 350 180 M	4 41
	33,1	5012	2,36	MR ICI 200 - 48 × 350 180 M	4 42,3
	32,9	5052	2,65	MR C2I 200 - 48 × 350 180 M	4 42,6
	36,6	4639	2,12	MR CI 200 - 55 × 400 200 LR	6 24,6
	37,4	4444	1,6	MR C2I 160 - 48 × 350 180 M	4 37,5
	37,5	4425	2	MR C2I 180 - 48 × 350 180 M	4 37,3
	39,7	4187	3	MR C2I 200 - 48 × 350 180 M	4 35,3
	42,3	3923	1,5	MR ICI 160 - 48 × 350 180 M	4 33,1
	43,1	3852	1,6	MR C2I 160 - 48 × 350 180 M	4 32,5
	45,5	3728	1,06	MR CI 160 - 48 × 350 180 M	4 30,8
	45,7	3711	1,5	MR CI 160 - 55 × 400 200 LR	6 19,7
	43,8	3795	2,12	MR ICI 180 - 48 × 350 180 M	4 32
	41,6	3995	2	MR C2I 180 - 48 × 350 180 M	4 33,7
	44,4	3823	1,8	MR CI 180 - 55 × 400 200 LR	6 20,3
	42	3952	3,35	MR ICI 200 - 48 × 350 180 M	4 33,3
	43,4	3829	3,35	MR C2I 200 - 48 × 350 180 M	4 32,3
	45,5	3728	2,12	MR CI 200 - 48 × 350 180 M	4 30,8
	45,7	3711	3,15	MR CI 200 - 55 × 400 200 LR	6 19,7
	47,1	3523	2	MR C2I 160 - 48 × 350 180 M	4 29,7
	47,3	3508	2,5	MR C2I 180 - 48 × 350 180 M	4 29,6
	48,2	3518	2	MR CI 180 - 55 × 400 200 LR	6 18,7
	50	3319	3,75	MR C2I 200 - 48 × 350 180 M	4 28
	56	3029	0,8	MR CI 125 - 48 × 350 180 M	4 25
	53,7	3093	2,12	MR ICI 160 - 48 × 350 180 M	4 26,1
54,4	3053	2,12	MR C2I 160 - 48 × 350 180 M	4 25,7	
56,9	2982	1,6	MR CI 160 - 48 × 350 180 M	4 24,6	
52,4	3167	2,65	MR C2I 180 - 48 × 350 180 M	4 26,7	
56,3	3014	2,36	MR CI 180 - 55 × 400 200 LR	6 16	
56,9	2982	3,15	MR CI 200 - 48 × 350 180 M	4 24,6	
70	2423	1,06	MR CI 125 - 48 × 350 180 M	4 20	
70	2423	1,4	MR CI 140 - 48 × 350 180 M	4 20	
70,8	2345	2,24	MR ICI 160 - 48 × 350 180 M	4 19,8	
71,1	2386	2,24	MR CI 160 - 48 × 350 180 M	4 19,7	
69	2458	2,8	MR CI 180 - 48 × 350 180 M	4 20,3	

1) Powers valid for continuous duty S1; **increase possible** for duty cycles S2 ... S10 (see ch. 1 «General specifications»); in which case M_2 increases and f_s decreases.

2) For complete designation when ordering see ch. 2.

* Mounting position **B5R** (see ch. 1.2).

13 - Selection tables (bevel helical gearmotors)

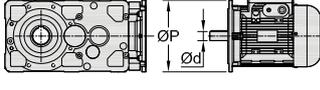

P_1 kW	n_2 min ⁻¹	M_2 N m	f_s		i
1)				2)	
18,5	77,8	2181	1,6	MR CI 140 - 48 × 350 180 M	4 18
	77,8	2181	2,5	MR CI 160 - 48 × 350 180 M	4 18
	87,5	1938	1,32	MR CI 125 - 48 × 350 180 M	4 16
	88,8	1910	1,8	MR CI 140 - 48 × 350 180 M	4 15,8
	84,7	2003	2,5	MR CI 160 - 48 × 350 180 M	4 16,5
	98,6	1719	2	MR CI 140 - 48 × 350 180 M	4 14,2
	98,6	1719	3,15	MR CI 160 - 48 × 350 180 M	4 14,2
	111	1528	1,7	MR CI 125 - 48 × 350 180 M	4 12,6
	109	1558	2	MR CI 140 - 48 × 350 180 M	4 12,9
	107	1579	3,55	MR CI 160 - 48 × 350 180 M	4 13
	122	1392	2	MR CI 140 - 48 × 350 180 M	4 11,5
	123	1381	3,55	MR CI 160 - 48 × 350 180 M	4 11,4
	135	1255	1,8	MR CI 125 - 48 × 350 180 M	4 10,4
	142	1194	2	MR CI 140 - 48 × 350 180 M	4 9,86
	142	1197	3,55	MR CI 160 - 48 × 350 180 M	4 9,88
	175	966	1,8	MR CI 125 - 48 × 350 180 M	4 7,98
	182	934	3,55	MR CI 160 - 48 × 350 180 M	4 7,71
	222	764	1,8	MR CI 125 - 48 × 350 180 M	4 6,31
	227	746	3,55	MR CI 160 - 48 × 350 180 M	4 6,16
	22	5,85	33760	1,12	MR C2I 280 - 55 × 400 200 L
5,76		34279	1,32	MR C2I 320 - 55 × 400 200 L	6 156
5,76		34279	1,6	MR C2I 321 - 55 × 400 200 L	6 156
5,59		35312	2,12	MR C2I 360 - 55 × 400 200 L	6 161
7,31		27008	1,18	MR C2I 250 - 55 × 400 200 L	6 123
7,17		27527	1,32	MR C2I 280 - 55 × 400 200 L	6 125
6,97		28316	1,9	MR C2I 320 - 55 × 400 200 L	6 129
6,97		28316	2,36	MR C2I 321 - 55 × 400 200 L	6 129
8,96		22037	1,18	MR C2I 250 - 48 × 350 180 L	4 156
9,14		21606	1,4	MR C2I 250 - 55 × 400 200 L	6 98,5
9,1		21703	1,6	MR C2I 280 - 48 × 350 180 L	4 154
8,97		22022	1,8	MR C2I 280 - 55 × 400 200 L	6 100
9,97		19806	1	MR C2I 225 - 55 × 400 200 L	6 90,3
10,1		19529	1,6	MR C2I 250 - 55 × 400 200 L	6 89
10		19677	2	MR C2I 280 - 55 × 400 200 L	6 89,7
11,2		17672	1	MR C2I 225 - 48 × 350 180 L	4 125
11,2		17594	1,18	MR C2I 225 - 55 × 400 200 L	6 80,2
11,4		17362	1,7	MR C2I 250 - 48 × 350 180 L	4 123
11,2		17696	2	MR C2I 280 - 48 × 350 180 L	4 125
13,8		14353	1	MR C2I 200 - 48 × 350 180 L	4 102
14		14138	1,32	MR C2I 225 - 48 × 350 180 L	4 100
14,2		13890	2	MR C2I 250 - 48 × 350 180 L	4 98,5
14		14157	2,65	MR C2I 280 - 48 × 350 180 L	4 100
15,9		12402	1,18	MR C2I 200 - 48 × 350 180 L	4 87,9
15,5		12732	1,5	MR C2I 225 - 48 × 350 180 L	4 90,3
15,7		12554	2,36	MR C2I 250 - 48 × 350 180 L	4 89
18,3		10803	1	MR ICI 200 - 55 × 400 200 L	6 49,2
17,2		11482	1,18	MR C2I 200 - 48 × 350 180 L	4 81,4
17,5		11310	1,7	MR C2I 225 - 48 × 350 180 L	4 80,2
17,8		11112	2,5	MR C2I 250 - 48 × 350 180 L	4 78,8
19,9		9921	1,5	MR C2I 200 - 48 × 350 180 L	4 70,3
19,4		10186	1,8	MR C2I 225 - 48 × 350 180 L	4 72,2
19,7		10043	2,8	MR C2I 250 - 48 × 350 180 L	4 71,2
21,4		9240	1	MR C2I 180 - 48 × 350 180 L	4 65,5
22,3		8874	1,25	MR ICI 200 - 48 × 350 180 L	4 62,9
21,8		9053	1,5	MR C2I 200 - 48 × 350 180 L	4 64,2
22,1		8918	2,24	MR C2I 225 - 48 × 350 180 L	4 63,2
24,7		8008	1	MR C2I 180 - 48 × 350 180 L	4 56,8
25,2		7822	1,9	MR C2I 200 - 48 × 350 180 L	4 55,5
24,6		8031	2,24	MR C2I 225 - 48 × 350 180 L	4 56,9
26,8		7356	0,95	MR C2I 160 - 48 × 350 180 L	4 52,1
26,7		7392	1,25	MR C2I 180 - 48 × 350 180 L	4 52,4
27,8		7099	1,6	MR ICI 200 - 48 × 350 180 L	4 50,3
26		7601	1,8	MR C2I 200 - 48 × 350 180 L	4 53,9
29,3		6896	1,18	MR CI 200 - 55 × 400 200 L	6 30,8
26,4		7487	2,36	MR C2I 225 - 48 × 350 180 L	4 53,1

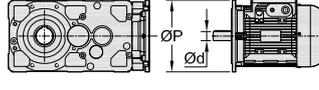
P_1 kW	n_2 min ⁻¹	M_2 N m	f_s		i
1)				2)	
22	30,7	6434	1,18	MR C2I 160 - 48 × 350 180 L	4 45,6
	30,8	6407	1,4	MR C2I 180 - 48 × 350 180 L	4 45,4
	30,1	6568	2,24	MR C2I 200 - 48 × 350 180 L	4 46,6
	29,3	6743	2,65	MR C2I 225 - 48 × 350 180 L	4 47,8
	35,5	5556	1	MR ICI 160 - 48 × 350 180 L	4 39,4
	35,4	5576	1,32	MR C2I 160 - 48 × 350 180 L	4 39,5
	36,6	5516	0,9	MR CI 160 - 55 × 400 200 L	6 24,6
	34,5	5723	1,25	MR ICI 180 - 48 × 350 180 L	4 40,6
	34,1	5784	1,5	MR C2I 180 - 48 × 350 180 L	4 41
	33,1	5960	2	MR ICI 200 - 48 × 350 180 L	4 42,3
	32,9	6007	2,24	MR C2I 200 - 48 × 350 180 L	4 42,6
	36,6	5516	1,8	MR CI 200 - 55 × 400 200 L	6 24,6
	33,8	5841	3,15	MR C2I 225 - 48 × 350 180 L	4 41,4
	37,4	5285	1,32	MR C2I 160 - 48 × 350 180 L	4 37,5
	37,5	5263	1,7	MR C2I 180 - 48 × 350 180 L	4 37,3
	39,7	4979	2,65	MR C2I 200 - 48 × 350 180 L	4 35,3
	42,3	4665	1,25	MR ICI 160 - 48 × 350 180 L	4 33,1
	43,1	4580	1,4	MR C2I 160 - 48 × 350 180 L	4 32,5
	45,7	4413	1,32	MR CI 160 - 55 × 400 200 L	6 19,7
	43,8	4513	1,8	MR ICI 180 - 48 × 350 180 L	4 32
	41,6	4751	1,7	MR C2I 180 - 48 × 350 180 L	4 33,7
	44,4	4546	1,6	MR CI 180 - 55 × 400 200 L	6 20,3
	42	4700	2,8	MR ICI 200 - 48 × 350 180 L	4 33,3
	43,4	4554	2,8	MR C2I 200 - 48 × 350 180 L	4 32,3
	45,5	4433	1,8	MR CI 200 - 48 × 350 180 L	4 30,8
	45,7	4413	2,65	MR CI 200 - 55 × 400 200 L	6 19,7
	47,1	4189	1,7	MR C2I 160 - 48 × 350 180 L	4 29,7
	50	4034	1,4	MR CI 160 - 55 × 400 200 L	6 18
	47,3	4172	2,12	MR C2I 180 - 48 × 350 180 L	4 29,6
	48,2	4183	1,7	MR CI 180 - 55 × 400 200 L	6 18,7
	50	3947	3,15	MR C2I 200 - 48 × 350 180 L	4 28
	53,7	3678	1,8	MR ICI 160 - 48 × 350 180 L	4 26,1
	54,4	3631	1,7	MR C2I 160 - 48 × 350 180 L	4 25,7
	56,9	3546	1,32	MR CI 160 - 48 × 350 180 L	4 24,6
	53,4	3696	1,9	MR ICI 180 - 48 × 350 180 L	4 26,2
	52,4	3766	2,24	MR C2I 180 - 48 × 350 180 L	4 26,7
	56,3	3584	2	MR CI 180 - 55 × 400 200 L	6 16
	53,2	3714	3	MR ICI 200 - 48 × 350 180 L	4 26,3
	54,7	3610	3,55	MR C2I 200 - 48 × 350 180 L	4 25,6
	56,9	3546	2,65	MR CI 200 - 48 × 350 180 L	4 24,6
	61,1	3298	2,36	MR CI 180 - 55 × 400 200 L	6 14,7
	70	2881	0,9	MR CI 125 - 48 × 350 180 L	4 20
	70	2881	1,18	MR CI 140 - 48 × 350 180 L	4 20
	70,8	2788	1,9	MR ICI 160 - 48 × 350 180 L	4 19,8
	71,1	2837	1,9	MR CI 160 - 48 × 350 180 L	4 19,7
	69	2923	2,36	MR CI 180 - 48 × 350 180 L	4 20,3
	77,8	2593	1,32	MR CI 140 - 48 × 350 180 L	4 18
	77,8	2593	2,12	MR CI 160 - 48 × 350 180 L	4 18
	87,5	2305	1,06	MR CI 125 - 48 × 350 180 L	4 16
	88,8	2272	1,5	MR CI 140 - 48 × 350 180 L	4 15,8
84,7	2382	2,12	MR CI 160 - 48 × 350 180 L	4 16,5	
98,6	2045	1,7	MR CI 140 - 48 × 350 180 L	4 14,2	
98,6	2045	2,65	MR CI 160 - 48 × 350 180 L	4 14,2	
111	1817	1,5	MR CI 125 - 48 × 350 180 L	4 12,6	
109	1852	1,7	MR CI 140 - 48 × 350 180 L	4 12,9	
107	1878	3	MR CI 160 - 48 × 350 180 L	4 13	
122	1655	1,7	MR CI 140 - 48 × 350 180 L	4 11,5	
123	1643	3	MR CI 160 - 48 × 350 180 L	4 11,4	
135	1493	1,5	MR CI 125 - 48 × 350 180 L	4 10,4	
142	1420	1,7	MR CI 140 - 48 × 350 180 L	4 9,86	
142	1424	3	MR CI 160 - 48 × 350 180 L	4 9,88	
175	1149	1,5	MR CI 125 - 48 × 350 180 L	4 7,98	
182	1111	3	MR CI 160 - 48 × 350 180 L	4 7,71	
222	909	1,5	MR CI 125 - 48 × 350 180 L	4 6,31	
227	887	3	MR CI 160 - 48 × 350 180 L	4 6,16	

1) Powers valid for continuous duty S1; **increase possible** for duty cycles S2 ... S10 (see ch. 1 «General specifications»): in which case M_2 increases and f_s decreases.
 2) For complete designation when ordering see ch. 2.

13 - Selection tables (bevel helical gearmotors)

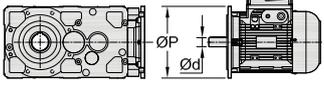

P_1 kW	n_2 min ⁻¹	M_2 N m	f_s		i	
1)				2)		
30	5,76	46744	1,18	MR C2I 321 - 60 × 450 225 M	6	156
	5,59	48153	1,6	MR C2I 360 - 60 × 450 225 M	6	161
	7,17	37537	0,95	MR C2I 280 - 60 × 450 225 M	6	125
	6,97	38613	1,4	MR C2I 320 - 60 × 450 225 M	6	129
	6,97	38613	1,7	MR C2I 321 - 60 × 450 225 M	6	129
	7,09	37980	1,9	MR C2I 360 - 60 × 450 225 M	6	127
	9,14	29463	1,06	MR C2I 250 - 60 × 450 225 M	6	98,5
	9,1	29595	1,18	MR C2I 280 - 55 × 400 200 L	4	154
	8,97	30030	1,32	MR C2I 280 - 60 × 450 225 M	6	100
	8,96	30050	1,4	MR C2I 320 - 55 × 400 200 L	4	156
	8,96	30050	1,8	MR C2I 321 - 55 × 400 200 L	4	156
	8,7	30955	2,36	MR C2I 360 - 55 × 400 200 L	4	161
	10,1	26630	1,18	MR C2I 250 - 60 × 450 225 M	6	89
	10	26832	1,5	MR C2I 280 - 60 × 450 225 M	6	89,7
	11,4	23676	1,25	MR C2I 250 - 55 × 400 200 L	4	123
	11,2	24131	1,5	MR C2I 280 - 55 × 400 200 L	4	125
	10,8	24822	2	MR C2I 320 - 55 × 400 200 L	4	129
	10,8	24822	2,5	MR C2I 321 - 55 × 400 200 L	4	129
	14	19279	1	MR C2I 225 - 55 × 400 200 L	4	100
	14,2	18940	1,5	MR C2I 250 - 55 × 400 200 L	4	98,5
	14	19305	1,9	MR C2I 280 - 55 × 400 200 L	4	100
	13,6	19858	2,5	MR C2I 320 - 55 × 400 200 L	4	103
	15,5	17362	1,12	MR C2I 225 - 55 × 400 200 L	4	90,3
	15,7	17119	1,7	MR C2I 250 - 55 × 400 200 L	4	89
	15,6	17249	2,24	MR C2I 280 - 55 × 400 200 L	4	89,7
	17,5	15423	1,25	MR C2I 225 - 55 × 400 200 L	4	80,2
	17,8	15152	1,8	MR C2I 250 - 55 × 400 200 L	4	78,8
	17,4	15444	2,36	MR C2I 280 - 55 × 400 200 L	4	80,3
	19,9	13529	1,06	MR C2I 200 - 55 × 400 200 L	4	70,3
	19,4	13890	1,32	MR C2I 225 - 55 × 400 200 L	4	72,2
	19,7	13695	2,12	MR C2I 250 - 55 × 400 200 L	4	71,2
	19,5	13799	3	MR C2I 280 - 55 × 400 200 L	4	71,7
	22,3	12101	0,9	MR ICI 200 - 55 × 400 200 L	4	62,9
	21,8	12345	1,12	MR C2I 200 - 55 × 400 200 L	4	64,2
	22,1	12160	1,6	MR C2I 225 - 55 × 400 200 L	4	63,2
	22,5	11947	2,36	MR C2I 250 - 55 × 400 200 L	4	62,1
	25,2	10667	1,4	MR C2I 200 - 55 × 400 200 L	4	55,5
	24,6	10951	1,6	MR C2I 225 - 55 × 400 200 L	4	56,9
	24,9	10798	2,65	MR C2I 250 - 55 × 400 200 L	4	56,1
	26,7	10080	0,9	MR C2I 180 - 48 × 350 200 L	* 4	52,4
	28,4	9470	1,18	MR ICI 200 - 55 × 400 200 L	4	49,2
	26	10365	1,32	MR C2I 200 - 55 × 400 200 L	4	53,9
	26,4	10210	1,7	MR C2I 225 - 55 × 400 200 L	4	53,1
	26,8	10031	2,8	MR C2I 250 - 55 × 400 200 L	4	52,1
	28,4	9697	1,7	MR CI 250 - 60 × 450 225 M	6	31,7
	30,8	8736	1,06	MR C2I 180 - 48 × 350 200 L	* 4	45,4
	30,1	8956	1,6	MR C2I 200 - 55 × 400 200 L	4	46,6
	29,3	9195	2	MR C2I 225 - 55 × 400 200 L	4	47,8
	29,7	9066	3,15	MR C2I 250 - 55 × 400 200 L	4	47,1
	32,2	8531	1,7	MR CI 250 - 60 × 450 225 M	6	27,9
34,5	7804	0,95	MR ICI 180 - 48 × 350 200 L	* 4	40,6	
34,1	7887	1,06	MR C2I 180 - 48 × 350 200 L	* 4	41	
35,5	7576	1,5	MR ICI 200 - 55 × 400 200 L	4	39,4	
32,9	8192	1,6	MR C2I 200 - 55 × 400 200 L	4	42,6	
36,6	7522	1,32	MR CI 200 - 60 × 450 225 M	6	24,6	
33,8	7965	2,24	MR C2I 225 - 55 × 400 200 L	4	41,4	
35,5	7758	2,65	MR CI 250 - 60 × 450 225 M	6	25,4	
37,5	7176	1,25	MR C2I 180 - 48 × 350 200 L	* 4	37,3	
39,7	6789	1,9	MR C2I 200 - 55 × 400 200 L	4	35,3	
38,6	6970	2,5	MR C2I 225 - 55 × 400 200 L	4	36,2	
45,7	6018	0,95	MR CI 160 - 60 × 450 225 M	6	19,7	
43,8	6154	1,32	MR ICI 180 - 48 × 350 200 L	* 4	32	
41,6	6479	1,25	MR C2I 180 - 48 × 350 200 L	* 4	33,7	
44,4	6199	1,12	MR CI 180 - 60 × 450 225 M	6	20,3	
42,3	6361	1,8	MR ICI 200 - 55 × 400 200 L	4	33,1	
43,4	6210	2,12	MR C2I 200 - 55 × 400 200 L	4	32,3	
45,5	6045	1,32	MR CI 200 - 55 × 400 200 L	4	30,8	
45,7	6018	1,9	MR CI 200 - 60 × 450 225 M	6	19,7	
44,6	6038	2,5	MR C2I 225 - 55 × 400 200 L	4	31,4	
44,4	6199	2,24	MR CI 225 - 60 × 450 225 M	6	20,3	

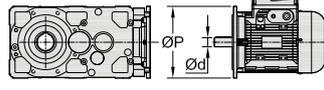
P_1 kW	n_2 min ⁻¹	M_2 N m	f_s		i		
1)				2)			
30	50	5501	1	MR CI 160 - 60 × 450 225 M	6	18	
	47,3	5688	1,6	MR C2I 180 - 48 × 350 200 L	* 4	29,6	
	48,2	5705	1,25	MR CI 180 - 60 × 450 225 M	6	18,7	
	50	5382	2,36	MR C2I 200 - 55 × 400 200 L	4	28	
	48,7	5525	3,35	MR C2I 225 - 55 × 400 200 L	4	28,7	
	56,9	4836	1	MR CI 160 - 55 × 400 200 L	4	24,6	
	53,4	5040	1,4	MR ICI 180 - 48 × 350 200 L	* 4	26,2	
	52,4	5135	1,6	MR C2I 180 - 48 × 350 200 L	* 4	26,7	
	56,3	4888	1,5	MR CI 180 - 60 × 450 225 M	6	16	
	53,7	5015	2,65	MR ICI 200 - 55 × 400 200 L	4	26,1	
	54,7	4922	2,65	MR C2I 200 - 55 × 400 200 L	4	25,6	
	56,9	4836	2	MR CI 200 - 55 × 400 200 L	4	24,6	
	56,3	4786	3,35	MR C2I 225 - 55 × 400 200 L	4	24,9	
	61,1	4498	1,7	MR CI 180 - 60 × 450 225 M	6	14,7	
	70	3929	0,85	MR CI 140 - 48 × 350 200 L	* 4	20	
	71,1	3869	1,4	MR CI 160 - 55 × 400 200 L	4	19,7	
	69	3985	1,7	MR CI 180 - 55 × 400 200 L	4	20,3	
	67,9	3964	2,8	MR ICI 200 - 55 × 400 200 L	4	20,6	
	71,1	3869	3	MR CI 200 - 55 × 400 200 L	4	19,7	
	77,8	3536	0,95	MR CI 140 - 48 × 350 200 L	* 4	18	
	77,8	3536	1,5	MR CI 160 - 55 × 400 200 L	4	18	
	75	3667	1,9	MR CI 180 - 55 × 400 200 L	4	18,7	
	77,8	3536	3	MR CI 200 - 55 × 400 200 L	4	18	
	88,8	3098	1,06	MR CI 140 - 48 × 350 200 L	* 4	15,8	
	84,7	3248	1,5	MR CI 160 - 55 × 400 200 L	4	16,5	
	87,5	3142	2,24	MR CI 180 - 55 × 400 200 L	4	16	
	98,6	2788	1,25	MR CI 140 - 48 × 350 200 L	* 4	14,2	
	98,6	2788	2	MR CI 160 - 55 × 400 200 L	4	14,2	
	95,1	2891	2,5	MR CI 180 - 55 × 400 200 L	4	14,7	
	109	2526	1,25	MR CI 140 - 48 × 350 200 L	* 4	12,9	
	107	2561	2,24	MR CI 160 - 55 × 400 200 L	4	13	
	122	2257	1,25	MR CI 140 - 48 × 350 200 L	* 4	11,5	
	123	2240	2,24	MR CI 160 - 55 × 400 200 L	4	11,4	
	142	1936	1,25	MR CI 140 - 48 × 350 200 L	* 4	9,86	
	142	1941	2,24	MR CI 160 - 55 × 400 200 L	4	9,88	
	182	1515	2,24	MR CI 160 - 55 × 400 200 L	4	7,71	
	227	1210	2,24	MR CI 160 - 55 × 400 200 L	4	6,16	
	37	5,59	59388	1,25	MR C2I 360 - 65 × 550 250 M	6	161
		6,97	47622	1,12	MR C2I 320 - 65 × 550 250 M	6	129
		6,97	47622	1,4	MR C2I 321 - 65 × 550 250 M	6	129
7,09		46842	1,6	MR C2I 360 - 65 × 550 250 M	6	127	
8,97		37036	1,06	MR C2I 280 - 65 × 550 250 M	6	100	
8,96		37061	1,18	MR C2I 320 - 60 × 450 225 S	4	156	
8,96		37061	1,4	MR C2I 321 - 60 × 450 225 S	4	156	
8,72		38098	1,4	MR C2I 320 - 65 × 550 250 M	6	103	
8,72		38098	1,7	MR C2I 321 - 65 × 550 250 M	6	103	
8,7		38178	2	MR C2I 360 - 60 × 450 225 S	4	161	
8,86		37473	2,12	MR C2I 360 - 65 × 550 250 M	6	102	
10		33093	1,18	MR C2I 280 - 65 × 550 250 M	6	89,7	
11,4		29200	1	MR C2I 250 - 60 × 450 225 S	4	123	
11,2		29761	1,18	MR C2I 280 - 60 × 450 225 S	4	125	
11,2		29629	1,32	MR C2I 280 - 65 × 550 250 M	6	80,3	
10,8		30614	1,7	MR C2I 320 - 60 × 450 225 S	4	129	
10,8		30614	2,12	MR C2I 321 - 60 × 450 225 S	4	129	
11		30112	2,36	MR C2I 360 - 60 × 450 225 S	4	127	
14,2		23360	1,18	MR C2I 250 - 60 × 450 225 S	4	98,5	
14		23809	1,5	MR C2I 280 - 60 × 450 225 S	4	100	
13,6	24491	2	MR C2I 320 - 60 × 450 225 S	4	103		
13,6	24491	2,5	MR C2I 321 - 60 × 450 225 S	4	103		
15,5	21413	0,9	MR C2I 225 - 60 × 450 225 S	4	90,3		
15,7	21114	1,4	MR C2I 250 - 60 × 450 225 S	4	89		
15,6	21274	1,8	MR C2I 280 - 60 × 450 225 S	4	89,7		
15,8	21079	2,24	MR C2I 320 - 60 × 450 225 S	4	88,8		
17,5	19022	1,06	MR C2I 225 - 60 × 450 225 S	4	80,2		
17,8	18688	1,5	MR C2I 250 - 60 × 450 225 S	4	78,8		
17,4	19047	1,9	MR C2I 280 - 60 × 450 225 S	4	80,3		
17	19593	2,5	MR C2I 320 - 60 × 450 225 S	4	82,6		

1) Powers valid for continuous duty S1; **increase possible** for duty cycles S2 ... S10 (see ch. 1 «General specifications»): in which case M_2 increases and f_s decreases.

2) For complete designation when ordering see ch. 2.

* Mounting position **B5R** (see ch. 1.2).

13 - Selection tables (bevel helical gearmotors)

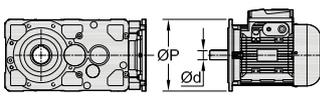

P_1 kW	n_2 min ⁻¹	M_2 N m	f_s		i
1)				2)	
37	19,4	17131	1,06	MR C2I 225 - 60 × 450 225 S	4 72,2
	19,7	16891	1,7	MR C2I 250 - 60 × 450 225 S	4 71,2
	19,5	17019	2,36	MR C2I 280 - 60 × 450 225 S	4 71,7
	22,1	14998	1,32	MR C2I 225 - 60 × 450 225 S	4 63,2
	22,5	14735	1,9	MR C2I 250 - 60 × 450 225 S	4 62,1
	22,1	15018	2,36	MR C2I 280 - 60 × 450 225 S	4 63,3
	25,2	13156	1,12	MR C2I 200 - 60 × 450 225 S	4 55,5
	24,6	13507	1,32	MR C2I 225 - 60 × 450 225 S	4 56,9
	24,9	13318	2,12	MR C2I 250 - 60 × 450 225 S	4 56,1
	24,8	13419	3	MR C2I 280 - 60 × 450 225 S	4 56,6
	28,4	11680	0,95	MR ICI 200 - 60 × 450 225 S	4 49,2
	26	12783	1,06	MR C2I 200 - 60 × 450 225 S	4 53,9
	26,4	12592	1,4	MR C2I 225 - 60 × 450 225 S	4 53,1
	26,8	12371	2,24	MR C2I 250 - 60 × 450 225 S	4 52,1
	28,4	11960	1,4	MR CI 250 - 65 × 550 250 M	6 31,7
	26,3	12609	2,8	MR C2I 280 - 60 × 450 225 S	4 53,1
	30,1	11046	1,32	MR C2I 200 - 60 × 450 225 S	4 46,6
	29,3	11340	1,6	MR C2I 225 - 60 × 450 225 S	4 47,8
	29,7	11182	2,5	MR C2I 250 - 60 × 450 225 S	4 47,1
	32,2	10522	1,4	MR CI 250 - 65 × 550 250 M	6 27,9
	35,5	9344	1,25	MR ICI 200 - 60 × 450 225 S	4 39,4
	32,9	10103	1,32	MR C2I 200 - 60 × 450 225 S	4 42,6
	36,6	9278	1,06	MR CI 200 - 65 × 550 250 M	6 24,6
	33,8	9824	1,8	MR C2I 225 - 60 × 450 225 S	4 41,4
	32,7	10162	2,8	MR C2I 250 - 60 × 450 225 S	4 42,8
	35,5	9568	2,12	MR CI 250 - 65 × 550 250 M	6 25,4
	39,7	8373	1,5	MR C2I 200 - 60 × 450 225 S	4 35,3
	38,6	8597	2	MR C2I 225 - 60 × 450 225 S	4 36,2
	37,6	8837	3	MR C2I 250 - 60 × 450 225 S	4 37,2
	40,3	8418	2,12	MR CI 250 - 65 × 550 250 M	6 22,3
	42,3	7845	1,5	MR ICI 200 - 60 × 450 225 S	4 33,1
	43,4	7659	1,7	MR C2I 200 - 60 × 450 225 S	4 32,3
	45,5	7455	1,06	MR CI 200 - 60 × 450 225 S	4 30,8
	45,7	7422	1,5	MR CI 200 - 65 × 550 250 M	6 19,7
	44,6	7447	2	MR C2I 225 - 60 × 450 225 S	4 31,4
	44,4	7646	1,8	MR CI 225 - 65 × 550 250 M	6 20,3
	41,4	8031	3,15	MR C2I 250 - 60 × 450 225 S	4 33,9
	44,1	7688	2,12	MR CI 250 - 60 × 450 225 S	4 31,7
	44,3	7654	2,8	MR CI 250 - 65 × 550 250 M	6 20,3
	50	6637	1,9	MR C2I 200 - 60 × 450 225 S	4 28
	48,7	6814	2,65	MR C2I 225 - 60 × 450 225 S	4 28,7
	48,2	7036	1,8	MR CI 225 - 65 × 550 250 M	6 18,7
	47,4	7005	3,75	MR C2I 250 - 60 × 450 225 S	4 29,5
	50,1	6764	2,12	MR CI 250 - 60 × 450 225 S	4 27,9
	53,7	6186	2,12	MR ICI 200 - 60 × 450 225 S	4 26,1
	54,7	6071	2,12	MR C2I 200 - 60 × 450 225 S	4 25,6
	56,9	5964	1,6	MR CI 200 - 60 × 450 225 S	4 24,6
	56,3	5903	2,8	MR C2I 225 - 60 × 450 225 S	4 24,9
	56,3	6028	2,36	MR CI 225 - 65 × 550 250 M	6 16
	52,2	6366	4	MR C2I 250 - 60 × 450 225 S	4 26,8
	55,2	6151	3,15	MR CI 250 - 60 × 450 225 S	4 25,4
	71,1	4771	1,12	MR CI 160 - 60 × 450 225 S	4 19,7
	69	4915	1,4	MR CI 180 - 60 × 450 225 S	4 20,3
	67,9	4889	2,24	MR ICI 200 - 60 × 450 225 S	4 20,6
	71,1	4771	2,36	MR CI 200 - 60 × 450 225 S	4 19,7
	69	4915	2,8	MR CI 225 - 60 × 450 225 S	4 20,3
	77,8	4361	1,25	MR CI 160 - 60 × 450 225 S	4 18
	75	4523	1,6	MR CI 180 - 60 × 450 225 S	4 18,7
	77,8	4361	2,5	MR CI 200 - 60 × 450 225 S	4 18
	84,7	4006	1,25	MR CI 160 - 60 × 450 225 S	4 16,5
	87,5	3875	1,8	MR CI 180 - 60 × 450 225 S	4 16
	84,7	4006	2,5	MR CI 200 - 60 × 450 225 S	4 16,5
	98,6	3439	1,6	MR CI 160 - 60 × 450 225 S	4 14,2
	95,1	3566	2	MR CI 180 - 60 × 450 225 S	4 14,7
	98,6	3439	3,35	MR CI 200 - 60 × 450 225 S	4 14,2
	107	3159	1,8	MR CI 160 - 60 × 450 225 S	4 13
	107	3174	2	MR CI 180 - 60 × 450 225 S	4 13,1
	107	3159	3,55	MR CI 200 - 60 × 450 225 S	4 13

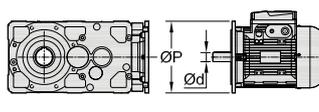
P_1 kW	n_2 min ⁻¹	M_2 N m	f_s		i	
1)				2)		
37	123	2763	1,8	MR CI 160 - 60 × 450 225 S	4 11,4	
	123	2751	2	MR CI 180 - 60 × 450 225 S	4 11,4	
	124	2729	3,55	MR CI 200 - 60 × 450 225 S	4 11,3	
	142	2394	1,8	MR CI 160 - 60 × 450 225 S	4 9,88	
	137	2484	2	MR CI 180 - 60 × 450 225 S	4 10,3	
	136	2496	3,55	MR CI 200 - 60 × 450 225 S	4 10,3	
	182	1868	1,8	MR CI 160 - 60 × 450 225 S	4 7,71	
	174	1953	3,55	MR CI 200 - 60 × 450 225 S	4 8,06	
	227	1492	1,8	MR CI 160 - 60 × 450 225 S	4 6,16	
	217	1565	3,55	MR CI 200 - 60 × 450 225 S	4 6,46	
	45	5,59	72229	1,06	MR C2I 360 - 75 × 550 280 S	6 161
		6,97	57919	1,12	MR C2I 321 - 75 × 550 280 S	6 129
		7,09	56969	1,32	MR C2I 360 - 75 × 550 280 S	6 127
		8,96	45075	0,95	MR C2I 320 - 60 × 450 225 M	4 156
		8,96	45075	1,18	MR C2I 321 - 60 × 450 225 M	4 156
		8,72	46335	1,12	MR C2I 320 - 75 × 550 280 S	6 103
		8,72	46335	1,4	MR C2I 321 - 75 × 550 280 S	6 103
		8,7	46433	1,6	MR C2I 360 - 60 × 450 225 M	4 161
		8,86	45576	1,7	MR C2I 360 - 75 × 550 280 S	6 102
		10	40249	0,95	MR C2I 280 - 75 × 550 280 S	6 89,7
10,1		39879	1,25	MR C2I 320 - 75 × 550 280 S	6 88,8	
11,2		36196	1	MR C2I 280 - 60 × 450 225 M	4 125	
11,2		36035	1,06	MR C2I 280 - 75 × 550 280 S	6 80,3	
10,8		37234	1,4	MR C2I 320 - 60 × 450 225 M	4 129	
10,8		37234	1,7	MR C2I 321 - 60 × 450 225 M	4 129	
11		36623	2	MR C2I 360 - 60 × 450 225 M	4 127	
14,2		28411	1	MR C2I 250 - 60 × 450 225 M	4 98,5	
14		28957	1,25	MR C2I 280 - 60 × 450 225 M	4 100	
13,6		29787	1,7	MR C2I 320 - 60 × 450 225 M	4 103	
13,6		29787	2,12	MR C2I 321 - 60 × 450 225 M	4 103	
13,8		29299	2,65	MR C2I 360 - 60 × 450 225 M	4 102	
15,7		25679	1,12	MR C2I 250 - 60 × 450 225 M	4 89	
15,6		25874	1,5	MR C2I 280 - 60 × 450 225 M	4 89,7	
15,8		25636	1,8	MR C2I 320 - 60 × 450 225 M	4 88,8	
15,8		25636	2,24	MR C2I 321 - 60 × 450 225 M	4 88,8	
17,8		22729	1,18	MR C2I 250 - 60 × 450 225 M	4 78,8	
17,4		23166	1,6	MR C2I 280 - 60 × 450 225 M	4 80,3	
17		23829	2	MR C2I 320 - 60 × 450 225 M	4 82,6	
17		23829	2,5	MR C2I 321 - 60 × 450 225 M	4 82,6	
19,4		20835	0,9	MR C2I 225 - 60 × 450 225 M	4 72,2	
19,7		20543	1,4	MR C2I 250 - 60 × 450 225 M	4 71,2	
19,5		20699	1,9	MR C2I 280 - 60 × 450 225 M	4 71,7	
19,7		20509	2,24	MR C2I 320 - 60 × 450 225 M	4 71,1	
22,1		18241	1,06	MR C2I 225 - 60 × 450 225 M	4 63,2	
22,5		17921	1,5	MR C2I 250 - 60 × 450 225 M	4 62,1	
22,1		18265	2	MR C2I 280 - 60 × 450 225 M	4 63,3	
21,5		18789	2,5	MR C2I 320 - 60 × 450 225 M	4 65,1	
24,6		16427	1,12	MR C2I 225 - 60 × 450 225 M	4 56,9	
24,9		16197	1,7	MR C2I 250 - 60 × 450 225 M	4 56,1	
24,8		16321	2,5	MR C2I 280 - 60 × 450 225 M	4 56,6	
26,4		15315	1,12	MR C2I 225 - 60 × 450 225 M	4 53,1	
26,8		15046	1,8	MR C2I 250 - 60 × 450 225 M	4 52,1	
28,4		14545	1,18	MR CI 250 - 75 × 550 280 S	6 31,7	
26,3		15335	2,36	MR C2I 280 - 60 × 450 225 M	4 53,1	
30,1		13434	1,06	MR C2I 200 - 60 × 450 225 M	4 46,6	
29,3		13792	1,32	MR C2I 225 - 60 × 450 225 M	4 47,8	
29,7		13599	2	MR C2I 250 - 60 × 450 225 M	4 47,1	
32,2		12797	1,18	MR CI 250 - 75 × 550 280 S	6 27,9	
29,5		13702	2,65	MR C2I 280 - 60 × 450 225 M	4 47,5	
35,5		11364	1	MR ICI 200 - 60 × 450 225 M	4 39,4	
32,9	12287	1,06	MR C2I 200 - 60 × 450 225 M	4 42,6		
36,6	11284	0,85	MR CI 200 - 75 × 550 280 S	6 24,6		
33,8	11948	1,5	MR C2I 225 - 60 × 450 225 M	4 41,4		
32,7	12359	2,36	MR C2I 250 - 60 × 450 225 M	4 42,8		
35,5	11636	1,7	MR CI 250 - 75 × 550 280 S	6 25,4		
33,7	11990	3	MR C2I 280 - 60 × 450 225 M	4 41,6		

13

1) Powers valid for continuous duty S1; **increase possible** for duty cycles S2 ... S10 (see ch. 1 «General specifications»): in which case M_2 increases and f_s decreases.
 2) For complete designation when ordering see ch. 2.

13 - Selection tables (bevel helical gearmotors)

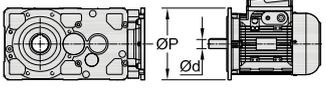

P_1 kW	n_2 min ⁻¹	M_2 N m	f_s		i	
1)				2)		
45	39,7	10184	1,25	MR C2I 200 - 60 × 450 225 M	4	35,3
	38,6	10455	1,7	MR C2I 225 - 60 × 450 225 M	4	36,2
	37,6	10748	2,5	MR C2I 250 - 60 × 450 225 M	4	37,2
	40,3	10238	1,7	MR CI 250 - 75 × 550 280 S	6	22,3
	42,3	9541	1,25	MR ICI 200 - 60 × 450 225 M	4	33,1
	43,4	9315	1,4	MR C2I 200 - 60 × 450 225 M	4	32,3
	45,7	9027	1,25	MR CI 200 - 75 × 550 280 S	6	19,7
	44,6	9057	1,7	MR C2I 225 - 60 × 450 225 M	4	31,4
	44,4	9299	1,5	MR CI 225 - 75 × 550 280 S	6	20,3
	41,4	9768	2,65	MR C2I 250 - 60 × 450 225 M	4	33,9
	44,1	9351	1,8	MR CI 250 - 60 × 450 225 M	4	31,7
	44,3	9309	2,36	MR CI 250 - 75 × 550 280 S	6	20,3
	50	8072	1,6	MR C2I 200 - 60 × 450 225 M	4	28
	50	8251	1,32	MR CI 200 - 75 × 550 280 S	6	18
	48,7	8288	2,12	MR C2I 225 - 60 × 450 225 M	4	28,7
	48,2	8557	1,5	MR CI 225 - 75 × 550 280 S	6	18,7
	47,4	8520	3,15	MR C2I 250 - 60 × 450 225 M	4	29,5
	50,1	8227	1,8	MR CI 250 - 60 × 450 225 M	4	27,9
	50,4	8190	2,65	MR CI 250 - 75 × 550 280 S	6	17,9
	47,1	8584	4,25	MR C2I 280 - 60 × 450 225 M	4	29,8
	53,7	7523	1,8	MR ICI 200 - 60 × 450 225 M	4	26,1
	54,7	7384	1,7	MR C2I 200 - 60 × 450 225 M	4	25,6
	56,9	7254	1,32	MR CI 200 - 60 × 450 225 M	4	24,6
	56,3	7180	2,24	MR C2I 225 - 60 × 450 225 M	4	24,9
	56,3	7332	2	MR CI 225 - 75 × 550 280 S	6	16
	52,2	7743	3,35	MR C2I 250 - 60 × 450 225 M	4	26,8
	55,2	7480	2,65	MR CI 250 - 60 × 450 225 M	4	25,4
	53,8	7511	4,5	MR C2I 280 - 60 × 450 225 M	4	26
	61,1	6747	2,24	MR CI 225 - 75 × 550 280 S	6	14,7
	62,7	6581	2,65	MR CI 250 - 60 × 450 225 M	4	22,3
	71,1	5803	0,95	MR CI 160 - 60 × 450 225 M	4	19,7
	69	5978	1,12	MR CI 180 - 60 × 450 225 M	4	20,3
	67,9	5946	1,8	MR ICI 200 - 60 × 450 225 M	4	20,6
	71,1	5803	1,9	MR CI 200 - 60 × 450 225 M	4	19,7
	69	5978	2,24	MR CI 225 - 60 × 450 225 M	4	20,3
	77,8	5304	1	MR CI 160 - 60 × 450 225 M	4	18
	75	5501	1,32	MR CI 180 - 60 × 450 225 M	4	18,7
	77,8	5304	2	MR CI 200 - 60 × 450 225 M	4	18
	75	5501	2,24	MR CI 225 - 60 × 450 225 M	4	18,7
	84,7	4872	1	MR CI 160 - 60 × 450 225 M	4	16,5
	87,5	4713	1,5	MR CI 180 - 60 × 450 225 M	4	16
	84,7	4872	2	MR CI 200 - 60 × 450 225 M	4	16,5
	87,5	4713	3	MR CI 225 - 60 × 450 225 M	4	16
	98,6	4182	1,32	MR CI 160 - 60 × 450 225 M	4	14,2
	95,1	4337	1,7	MR CI 180 - 60 × 450 225 M	4	14,7
98,6	4182	2,65	MR CI 200 - 60 × 450 225 M	4	14,2	
107	3841	1,5	MR CI 160 - 60 × 450 225 M	4	13	
107	3861	1,7	MR CI 180 - 60 × 450 225 M	4	13,1	
107	3841	3	MR CI 200 - 60 × 450 225 M	4	13	
123	3360	1,5	MR CI 160 - 60 × 450 225 M	4	11,4	
123	3346	1,7	MR CI 180 - 60 × 450 225 M	4	11,4	
124	3319	3	MR CI 200 - 60 × 450 225 M	4	11,3	
142	2912	1,5	MR CI 160 - 60 × 450 225 M	4	9,88	
137	3021	1,7	MR CI 180 - 60 × 450 225 M	4	10,3	
136	3036	3	MR CI 200 - 60 × 450 225 M	4	10,3	
182	2272	1,5	MR CI 160 - 60 × 450 225 M	4	7,71	
174	2375	3	MR CI 200 - 60 × 450 225 M	4	8,06	
227	1815	1,5	MR CI 160 - 60 × 450 225 M	4	6,16	
217	1903	3	MR CI 200 - 60 × 450 225 M	4	6,46	
55	8,7	56751	1,32	MR C2I 360 - 65 × 550 250 M	4	161
	10,8	45508	1,12	MR C2I 320 - 65 × 550 250 M	4	129
	10,8	45508	1,4	MR C2I 321 - 65 × 550 250 M	4	129
	11	44762	1,6	MR C2I 360 - 65 × 550 250 M	4	127
	14	35392	1,06	MR C2I 280 - 65 × 550 250 M	4	100
	13,6	36406	1,32	MR C2I 320 - 65 × 550 250 M	4	103
	13,6	36406	1,7	MR C2I 321 - 65 × 550 250 M	4	103
	13,8	35809	2,12	MR C2I 360 - 65 × 550 250 M	4	102
	15,6	31624	1,18	MR C2I 280 - 65 × 550 250 M	4	89,7
	15,8	31333	1,5	MR C2I 320 - 65 × 550 250 M	4	88,8
	15,8	31333	1,8	MR C2I 321 - 65 × 550 250 M	4	88,8
	15,3	32228	2,24	MR C2I 360 - 65 × 550 250 M	4	91,4
	17,8	27779	1	MR C2I 250 - 65 × 550 250 M	4	78,8
	17,4	28314	1,25	MR C2I 280 - 65 × 550 250 M	4	80,3
	17,7	29125	1,6	MR C2I 320 - 65 × 550 250 M	4	82,6
17	29125	2	MR C2I 321 - 65 × 550 250 M	4	82,6	
17,2	28647	2,5	MR C2I 360 - 65 × 550 250 M	4	81,2	
19,7	25108	1,12	MR C2I 250 - 65 × 550 250 M	4	71,2	
19,5	25299	1,6	MR C2I 280 - 65 × 550 250 M	4	71,7	
19,7	25067	1,8	MR C2I 320 - 65 × 550 250 M	4	71,1	
19,7	25067	2,24	MR C2I 321 - 65 × 550 250 M	4	71,1	
22,5	21903	1,25	MR C2I 250 - 65 × 550 250 M	4	62,1	
22,1	22324	1,6	MR C2I 280 - 65 × 550 250 M	4	63,3	
21,5	22964	2,12	MR C2I 320 - 65 × 550 250 M	4	65,1	
21,5	22964	2,65	MR C2I 321 - 65 × 550 250 M	4	65,1	
24,6	20078	0,9	MR C2I 225 - 60 × 450 250 M	* 4	56,9	
24,9	19797	1,4	MR C2I 250 - 65 × 550 250 M	4	56,1	
24,8	19947	2	MR C2I 280 - 65 × 550 250 M	4	56,6	
25	19764	2,24	MR C2I 320 - 65 × 550 250 M	4	56	
26,4	18718	0,95	MR C2I 225 - 60 × 450 250 M	* 4	53,1	
26,8	18389	1,5	MR C2I 250 - 65 × 550 250 M	4	52,1	
26,3	18743	1,9	MR C2I 280 - 65 × 550 250 M	4	53,1	
27,3	18093	2,65	MR C2I 320 - 65 × 550 250 M	4	51,3	
29,3	16857	1,06	MR C2I 225 - 60 × 450 250 M	* 4	47,8	
29,7	16621	1,7	MR C2I 250 - 65 × 550 250 M	4	47,1	
29,5	16747	2,12	MR C2I 280 - 65 × 550 250 M	4	47,5	
31,7	15572	2,8	MR C2I 320 - 65 × 550 250 M	4	44,2	
33,8	14603	1,25	MR C2I 225 - 60 × 450 250 M	* 4	41,4	
32,7	15106	1,9	MR C2I 250 - 65 × 550 250 M	4	42,8	
33,7	14654	2,36	MR C2I 280 - 65 × 550 250 M	4	41,6	
38,6	12779	1,4	MR C2I 225 - 60 × 450 250 M	* 4	36,2	
37,6	13136	2	MR C2I 250 - 65 × 550 250 M	4	37,2	
37,3	13236	2,65	MR C2I 280 - 65 × 550 250 M	4	37,5	
44,6	11070	1,4	MR C2I 225 - 60 × 450 250 M	* 4	31,4	
41,4	11938	2,12	MR C2I 250 - 65 × 550 250 M	4	33,9	
44,1	11429	1,5	MR CI 250 - 65 × 550 250 M	4	31,7	
42,6	11581	2,65	MR C2I 280 - 65 × 550 250 M	4	32,8	
48,7	10129	1,8	MR C2I 225 - 60 × 450 250 M	* 4	28,7	
47,4	10413	2,5	MR C2I 250 - 65 × 550 250 M	4	29,5	
50,1	10055	1,5	MR CI 250 - 65 × 550 250 M	4	27,9	
47,1	10492	3,35	MR C2I 280 - 65 × 550 250 M	4	29,8	
56,9	8866	1,06	MR CI 200 - 65 × 550 250 M	4	24,6	
56,3	8775	1,9	MR C2I 225 - 60 × 450 250 M	* 4	24,9	
52,2	9463	2,65	MR C2I 250 - 65 × 550 250 M	4	26,8	
55,2	9143	2,12	MR CI 250 - 65 × 550 250 M	4	25,4	
53,8	9180	3,55	MR C2I 280 - 65 × 550 250 M	4	26	
62,7	8044	2,12	MR CI 250 - 65 × 550 250 M	4	22,3	
69	7306	0,95	MR CI 180 - 60 × 450 250 M	* 4	20,3	
71,1	7093	1,6	MR CI 200 - 65 × 550 250 M	4	19,7	
69	7306	1,9	MR CI 225 - 65 × 550 250 M	4	20,3	
68,9	7314	2,8	MR CI 250 - 65 × 550 250 M	4	20,3	
75	6723	1,06	MR CI 180 - 60 × 450 250 M	* 4	18,7	
77,8	6483	1,7	MR CI 200 - 65 × 550 250 M	4	18	
75	6723	1,9	MR CI 225 - 65 × 550 250 M	4	18,7	
78,4	6435	3,35	MR CI 250 - 65 × 550 250 M	4	17,9	
87,5	5761	1,25	MR CI 180 - 60 × 450 250 M	* 4	16	
84,7	5955	1,7	MR CI 200 - 65 × 550 250 M	4	16,5	
87,5	5761	2,5	MR CI 225 - 65 × 550 250 M	4	16	
95,1	5301	1,4	MR CI 180 - 60 × 450 250 M	* 4	14,7	
98,6	5112	2,24	MR CI 200 - 65 × 550 250 M	4	14,2	
107	4718	1,4	MR CI 180 - 60 × 450 250 M	* 4	13,1	
107	4695	2,36	MR CI 200 - 65 × 550 250 M	4	13	
123	4089	1,4	MR CI 180 - 60 × 450 250 M	* 4	11,4	
124	4057	2,36	MR CI 200 - 65 × 550 250 M	4	11,3	

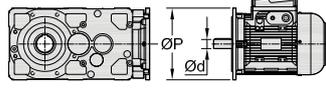
P_1 kW	n_2 min ⁻¹	M_2 N m	f_s		i	
1)				2)		
55	15,6	31624	1,18	MR C2I 280 - 65 × 550 250 M	4	89,7
	15,8	31333	1,5	MR C2I 320 - 65 × 550 250 M	4	88,8
	15,8	31333	1,8	MR C2I 321 - 65 × 550 250 M	4	88,8
	15,3	32228	2,24	MR C2I 360 - 65 × 550 250 M	4	91,4
	17,8	27779	1	MR C2I 250 - 65 × 550 250 M	4	78,8
	17,4	28314	1,25	MR C2I 280 - 65 × 550 250 M	4	80,3
	17,7	29125	1,6	MR C2I 320 - 65 × 550 250 M	4	82,6
	17	29125	2	MR C2I 321 - 65 × 550 250 M	4	82,6
	17,2	28647	2,5	MR C2I 360 - 65 × 550 250 M	4	81,2
	19,7	25108	1,12	MR C2I 250 - 65 × 550 250 M	4	71,2
	19,5	25299	1,6	MR C2I 280 - 65 × 550 250 M	4	71,7
	19,7	25067	1,8	MR C2I 320 - 65 × 550 250 M	4	71,1
	19,7	25067	2,24			

13 - Selection tables (bevel helical gearmotors)

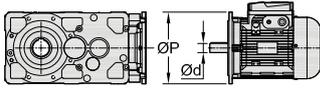

P_1 kW	n_2 min ⁻¹	M_2 N m	f_s		i
1)				2)	
55	137	3692	1,4	MR CI 180 - 60 × 450 250 M	* 4 10,3
	136	3711	2,36	MR CI 200 - 65 × 550 250 M	4 10,3
	174	2903	2,36	MR CI 200 - 65 × 550 250 M	4 8,06
	217	2326	2,36	MR CI 200 - 65 × 550 250 M	4 6,46
75	10,8	62056	1	MR C2I 321 - 75 × 550 280 S	4 129
	11	61039	1,18	MR C2I 360 - 75 × 550 280 S	4 127
	13,6	49645	1	MR C2I 320 - 75 × 550 280 S	4 103
	13,6	49645	1,25	MR C2I 321 - 75 × 550 280 S	4 103
	13,8	48831	1,6	MR C2I 360 - 75 × 550 280 S	4 102
	15,8	42727	1,06	MR C2I 320 - 75 × 550 280 S	4 88,8
	15,8	42727	1,32	MR C2I 321 - 75 × 550 280 S	4 88,8
	15,3	43948	1,6	MR C2I 360 - 75 × 550 280 S	4 91,4
	17,4	38609	0,95	MR C2I 280 - 75 × 550 280 S	4 80,3
	17	39716	1,18	MR C2I 320 - 75 × 550 280 S	4 82,6
	17	39716	1,5	MR C2I 321 - 75 × 550 280 S	4 82,6
	17,2	39065	1,9	MR C2I 360 - 75 × 550 280 S	4 81,2
	19,5	34499	1,18	MR C2I 280 - 75 × 550 280 S	4 71,7
	19,7	34182	1,32	MR C2I 320 - 75 × 550 280 S	4 71,1
	19,7	34182	1,6	MR C2I 321 - 75 × 550 280 S	4 71,1
	19,1	35158	2	MR C2I 360 - 75 × 550 280 S	4 73,1
	22,5	29868	0,9	MR C2I 250 - 75 × 550 280 S	4 62,1
	22,1	30442	1,18	MR C2I 280 - 75 × 550 280 S	4 63,3
	21,5	31314	1,5	MR C2I 320 - 75 × 550 280 S	4 65,1
	21,5	31314	1,9	MR C2I 321 - 75 × 550 280 S	4 65,1
	21,9	30801	2,36	MR C2I 360 - 75 × 550 280 S	4 64
	24,9	26996	1,06	MR C2I 250 - 75 × 550 280 S	4 56,1
	24,8	27201	1,5	MR C2I 280 - 75 × 550 280 S	4 56,6
	25	26951	1,7	MR C2I 320 - 75 × 550 280 S	4 56
	25	26951	2,12	MR C2I 321 - 75 × 550 280 S	4 56
	24,3	27721	2,5	MR C2I 360 - 75 × 550 280 S	4 57,6
	26,8	25076	1,12	MR C2I 250 - 75 × 550 280 S	4 52,1
	26,3	25559	1,4	MR C2I 280 - 75 × 550 280 S	4 53,1
	27,3	24672	1,9	MR C2I 320 - 75 × 550 280 S	4 51,3
	27,3	24672	2,36	MR C2I 321 - 75 × 550 280 S	4 51,3
	27,7	24267	2,8	MR C2I 360 - 75 × 550 280 S	4 50,5
	29,7	22665	1,25	MR C2I 250 - 75 × 550 280 S	4 47,1
	29,5	22837	1,6	MR C2I 280 - 75 × 550 280 S	4 47,5
	31,7	21234	2,12	MR C2I 320 - 75 × 550 280 S	4 44,2
	32,7	20598	1,4	MR C2I 250 - 75 × 550 280 S	4 42,8
	33,7	19983	1,8	MR C2I 280 - 75 × 550 280 S	4 41,6
	35,4	19010	2,36	MR C2I 320 - 75 × 550 280 S	4 39,5
	37,6	17913	1,5	MR C2I 250 - 75 × 550 280 S	4 37,2
	37,3	18049	2	MR C2I 280 - 75 × 550 280 S	4 37,5
	38,6	17442	2,65	MR C2I 320 - 75 × 550 280 S	4 36,3
	41,4	16279	1,6	MR C2I 250 - 75 × 550 280 S	4 33,9
	44,1	15584	1,06	MR CI 250 - 75 × 550 280 S	4 31,7
	42,6	15793	2	MR C2I 280 - 75 × 550 280 S	4 32,8
	43,1	15615	2,8	MR C2I 320 - 75 × 550 280 S	4 32,5
	47,4	14199	1,9	MR C2I 250 - 75 × 550 280 S	4 29,5
	50,1	13711	1,06	MR CI 250 - 75 × 550 280 S	4 27,9
	47,1	14307	2,5	MR C2I 280 - 75 × 550 280 S	4 29,8
	48,7	13826	3,35	MR C2I 320 - 75 × 550 280 S	4 28,8
	52,2	12904	2	MR C2I 250 - 75 × 550 280 S	4 26,8
	55,2	12467	1,6	MR CI 250 - 75 × 550 280 S	4 25,4
	53,8	12519	2,65	MR C2I 280 - 75 × 550 280 S	4 26
	54,4	12378	3,55	MR C2I 320 - 75 × 550 280 S	4 25,7
	62,7	10969	1,6	MR CI 250 - 75 × 550 280 S	4 22,3
	71,1	9672	1,18	MR CI 200 - 75 × 550 280 S	4 19,7
	69	9963	1,32	MR CI 225 - 75 × 550 280 S	4 20,3
	68,9	9974	2,12	MR CI 250 - 75 × 550 280 S	4 20,3
	70	9823	2,65	MR CI 280 - 75 × 550 280 S	4 20
	77,8	8841	1,18	MR CI 200 - 75 × 550 280 S	4 18
75	9168	1,32	MR CI 225 - 75 × 550 280 S	4 18,7	
78,4	8775	2,36	MR CI 250 - 75 × 550 280 S	4 17,9	

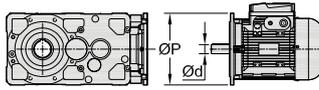
P_1 kW	n_2 min ⁻¹	M_2 N m	f_s		i	
1)				2)		
75	84,7	8120	1,18	MR CI 200 - 75 × 550 280 S	4 16,5	
	87,5	7856	1,8	MR CI 225 - 75 × 550 280 S	4 16	
	87,5	7858	2,36	MR CI 250 - 75 × 550 280 S	4 16	
	98,6	6970	1,6	MR CI 200 - 75 × 550 280 S	4 14,2	
	95,1	7229	2	MR CI 225 - 75 × 550 280 S	4 14,7	
	107	6402	1,8	MR CI 200 - 75 × 550 280 S	4 13	
	109	6307	2	MR CI 225 - 75 × 550 280 S	4 12,8	
	124	5532	1,8	MR CI 200 - 75 × 550 280 S	4 11,3	
	121	5680	2	MR CI 225 - 75 × 550 280 S	4 11,6	
	136	5060	1,8	MR CI 200 - 75 × 550 280 S	4 10,3	
	140	4920	2	MR CI 225 - 75 × 550 280 S	4 10	
	174	3959	1,8	MR CI 200 - 75 × 550 280 S	4 8,06	
	217	3172	1,8	MR CI 200 - 75 × 550 280 S	4 6,46	
	90	11	73246	1	MR C2I 360 - 75 × 550 280 M	4 127
		13,6	59574	1,06	MR C2I 321 - 75 × 550 280 M	4 103
		13,8	58597	1,32	MR C2I 360 - 75 × 550 280 M	4 102
		15,8	51272	0,9	MR C2I 320 - 75 × 550 280 M	4 88,8
15,8		51272	1,12	MR C2I 321 - 75 × 550 280 M	4 88,8	
15,3		52737	1,32	MR C2I 360 - 75 × 550 280 M	4 91,4	
17		47659	1	MR C2I 320 - 75 × 550 280 M	4 82,6	
17		47659	1,25	MR C2I 321 - 75 × 550 280 M	4 82,6	
17,2		46878	1,6	MR C2I 360 - 75 × 550 280 M	4 81,2	
19,5		41398	0,95	MR C2I 280 - 75 × 550 280 M	4 71,7	
19,7		41018	1,12	MR C2I 320 - 75 × 550 280 M	4 71,1	
19,7		41018	1,4	MR C2I 321 - 75 × 550 280 M	4 71,1	
19,1		42190	1,7	MR C2I 360 - 75 × 550 280 M	4 73,1	
22,1		36530	1	MR C2I 280 - 75 × 550 280 M	4 63,3	
21,5		37577	1,25	MR C2I 320 - 75 × 550 280 M	4 65,1	
21,5		37577	1,6	MR C2I 321 - 75 × 550 280 M	4 65,1	
21,9		36961	2	MR C2I 360 - 75 × 550 280 M	4 64	
24,8		32641	1,25	MR C2I 280 - 75 × 550 280 M	4 56,6	
25		32341	1,4	MR C2I 320 - 75 × 550 280 M	4 56	
25		32341	1,7	MR C2I 321 - 75 × 550 280 M	4 56	
24,3		33265	2,12	MR C2I 360 - 75 × 550 280 M	4 57,6	
26,8		30092	0,9	MR C2I 250 - 75 × 550 280 M	4 52,1	
26,3		30670	1,18	MR C2I 280 - 75 × 550 280 M	4 53,1	
27,3		29606	1,6	MR C2I 320 - 75 × 550 280 M	4 51,3	
27,3		29606	2	MR C2I 321 - 75 × 550 280 M	4 51,3	
27,7		29121	2,36	MR C2I 360 - 75 × 550 280 M	4 50,5	
29,7		27198	1	MR C2I 250 - 75 × 550 280 M	4 47,1	
29,5		27405	1,32	MR C2I 280 - 75 × 550 280 M	4 47,5	
31,7		25481	1,8	MR C2I 320 - 75 × 550 280 M	4 44,2	
31,7		25481	2,24	MR C2I 321 - 75 × 550 280 M	4 44,2	
30,8		26209	2,65	MR C2I 360 - 75 × 550 280 M	4 45,4	
32,7		24718	1,18	MR C2I 250 - 75 × 550 280 M	4 42,8	
33,7	23979	1,5	MR C2I 280 - 75 × 550 280 M	4 41,6		
35,4	22811	2	MR C2I 320 - 75 × 550 280 M	4 39,5		
35,4	22811	2,5	MR C2I 321 - 75 × 550 280 M	4 39,5		
37,6	21495	1,25	MR C2I 250 - 75 × 550 280 M	4 37,2		
37,3	21659	1,6	MR C2I 280 - 75 × 550 280 M	4 37,5		
38,6	20931	2,12	MR C2I 320 - 75 × 550 280 M	4 36,3		
41,4	19535	1,32	MR C2I 250 - 75 × 550 280 M	4 33,9		
42,6	18951	1,7	MR C2I 280 - 75 × 550 280 M	4 32,8		
43,1	18738	2,36	MR C2I 320 - 75 × 550 280 M	4 32,5		
47,4	17039	1,5	MR C2I 250 - 75 × 550 280 M	4 29,5		
47,1	17169	2,12	MR C2I 280 - 75 × 550 280 M	4 29,8		
48,7	16591	2,65	MR C2I 320 - 75 × 550 280 M	4 28,8		
52,2	15485	1,7	MR C2I 250 - 75 × 550 280 M	4 26,8		
55,2	14961	1,32	MR CI 250 - 75 × 550 280 M	4 25,4		
53,8	15022	2,24	MR C2I 280 - 75 × 550 280 M	4 26		
54,4	14853	3	MR C2I 320 - 75 × 550 280 M	4 25,7		
62,7	13163	1,32	MR CI 250 - 75 × 550 280 M	4 22,3		

1) Powers valid for continuous duty S1; **increase possible** for duty cycles S2 ... S10 (see ch. 1 «General specifications»): in which case M_2 increases and f_s decreases.
 2) For complete designation when ordering see ch. 2.
 * Mounting position **B5R** (see ch. 1.2).

13 - Selection tables (bevel helical gearmotors)

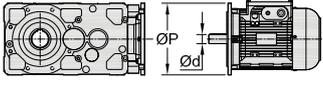

P_1 kW	n_2 min ⁻¹	M_2 N m	f_s		i
1)				2)	
90	71,1	11606	0,95	MR CI 200 - 75 × 550 280 M	4 19,7
	69	11956	1,12	MR CI 225 - 75 × 550 280 M	4 20,3
	68,9	11969	1,8	MR CI 250 - 75 × 550 280 M	4 20,3
	70	11787	2,24	MR CI 280 - 75 × 550 280 M	4 20
	77,8	10609	1	MR CI 200 - 75 × 550 280 M	4 18
	75	11002	1,12	MR CI 225 - 75 × 550 280 M	4 18,7
	78,4	10530	2	MR CI 250 - 75 × 550 280 M	4 17,9
	77,8	10609	2,24	MR CI 280 - 75 × 550 280 M	4 18
	84,7	9744	1	MR CI 200 - 75 × 550 280 M	4 16,5
	87,5	9427	1,5	MR CI 225 - 75 × 550 280 M	4 16
	87,5	9430	2	MR CI 250 - 75 × 550 280 M	4 16
	88,8	9294	3	MR CI 280 - 75 × 550 280 M	4 15,8
	98,6	8365	1,32	MR CI 200 - 75 × 550 280 M	4 14,2
	95,1	8674	1,7	MR CI 225 - 75 × 550 280 M	4 14,7
	99,4	8303	2,65	MR CI 250 - 75 × 550 280 M	4 14,1
	107	7683	1,5	MR CI 200 - 75 × 550 280 M	4 13
	109	7568	1,7	MR CI 225 - 75 × 550 280 M	4 12,8
	111	7435	3	MR CI 250 - 75 × 550 280 M	4 12,6
	124	6639	1,5	MR CI 200 - 75 × 550 280 M	4 11,3
	121	6816	1,7	MR CI 225 - 75 × 550 280 M	4 11,6
	123	6720	3	MR CI 250 - 75 × 550 280 M	4 11,4
136	6072	1,5	MR CI 200 - 75 × 550 280 M	4 10,3	
140	5904	1,7	MR CI 225 - 75 × 550 280 M	4 10	
135	6107	3	MR CI 250 - 75 × 550 280 M	4 10,4	
174	4750	1,5	MR CI 200 - 75 × 550 280 M	4 8,06	
217	3806	1,5	MR CI 200 - 75 × 550 280 M	4 6,46	
110	13,8	71619	1,06	MR C2I 360 - 80 × 660 315 S	4 102
	15,8	62666	0,9	MR C2I 321 - 80 × 660 315 S	4 88,8
	15,3	64457	1,12	MR C2I 360 - 80 × 660 315 S	4 91,4
	17	58250	1	MR C2I 321 - 80 × 660 315 S	4 82,6
	17,2	57295	1,32	MR C2I 360 - 80 × 660 315 S	4 81,2
	19,7	50133	0,9	MR C2I 320 - 80 × 660 315 S	4 71,1
	19,7	50133	1,12	MR C2I 321 - 80 × 660 315 S	4 71,1
	19,1	51565	1,4	MR C2I 360 - 80 × 660 315 S	4 73,1
	21,5	45928	1,06	MR C2I 320 - 80 × 660 315 S	4 65,1
	21,5	45928	1,32	MR C2I 321 - 80 × 660 315 S	4 65,1
	21,9	45175	1,6	MR C2I 360 - 80 × 660 315 S	4 64
	24,8	39895	1	MR C2I 280 - 75 × 550 315 S	* 4 56,6
	25	39528	1,12	MR C2I 320 - 80 × 660 315 S	4 56
	25	39528	1,4	MR C2I 321 - 80 × 660 315 S	4 56
	24,3	40657	1,7	MR C2I 360 - 80 × 660 315 S	4 57,6
	26,3	37486	0,95	MR C2I 280 - 75 × 550 315 S	* 4 53,1
	27,3	36186	1,32	MR C2I 320 - 80 × 660 315 S	4 51,3
	27,3	36186	1,6	MR C2I 321 - 80 × 660 315 S	4 51,3
	27,7	35592	1,9	MR C2I 360 - 80 × 660 315 S	4 50,5
	29,5	33495	1,06	MR C2I 280 - 75 × 550 315 S	* 4 47,5
	31,7	31143	1,4	MR C2I 320 - 80 × 660 315 S	4 44,2
	31,7	31143	1,8	MR C2I 321 - 80 × 660 315 S	4 44,2
	30,8	32033	2,24	MR C2I 360 - 80 × 660 315 S	4 45,4
	33,7	29308	1,18	MR C2I 280 - 75 × 550 315 S	* 4 41,6
	35,4	27881	1,6	MR C2I 320 - 80 × 660 315 S	4 39,5
	35,4	27881	2	MR C2I 321 - 80 × 660 315 S	4 39,5
	34,1	28919	2,5	MR C2I 360 - 80 × 660 315 S	4 41
	37,3	26472	1,32	MR C2I 280 - 75 × 550 315 S	* 4 37,5
	38,6	25582	1,8	MR C2I 320 - 80 × 660 315 S	4 36,3
	38,6	25582	2,24	MR C2I 321 - 80 × 660 315 S	4 36,3
	37,5	26313	2,65	MR C2I 360 - 80 × 660 315 S	4 37,3
	42,6	23163	1,32	MR C2I 280 - 75 × 550 315 S	* 4 32,8
	43,1	22902	2	MR C2I 320 - 80 × 660 315 S	4 32,5
	41,6	23755	2,65	MR C2I 360 - 80 × 660 315 S	4 33,7
	47,1	20984	1,7	MR C2I 280 - 75 × 550 315 S	* 4 29,8
	48,7	20278	2,24	MR C2I 320 - 80 × 660 315 S	4 28,8
48,7	20278	2,8	MR C2I 321 - 80 × 660 315 S	4 28,8	
47,3	20858	3,35	MR C2I 360 - 80 × 660 315 S	4 29,6	

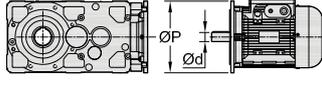
P_1 kW	n_2 min ⁻¹	M_2 N m	f_s		i
1)				2)	
110	55,2	18286	1,06	MR CI 250 - 80 × 660 315 S	4 25,4
	53,8	18361	1,8	MR C2I 280 - 75 × 550 315 S	* 4 26
	54,4	18154	2,5	MR C2I 320 - 80 × 660 315 S	4 25,7
	54,4	18154	3,15	MR C2I 321 - 80 × 660 315 S	4 25,7
	52,4	18830	3,55	MR C2I 360 - 80 × 660 315 S	4 26,7
	62,7	16088	1,06	MR CI 250 - 80 × 660 315 S	4 22,3
	69	14613	0,95	MR CI 225 - 75 × 550 315 S	* 4 20,3
	68,9	14629	1,4	MR CI 250 - 80 × 660 315 S	4 20,3
	70	14407	1,9	MR CI 280 - 80 × 660 315 S	4 20
	75	13446	0,95	MR CI 225 - 75 × 550 315 S	* 4 18,7
	78,4	12870	1,7	MR CI 250 - 80 × 660 315 S	4 17,9
	77,8	12966	1,9	MR CI 280 - 80 × 660 315 S	4 18
	87,5	11522	1,25	MR CI 225 - 75 × 550 315 S	* 4 16
	87,5	11525	1,7	MR CI 250 - 80 × 660 315 S	4 16
	88,8	11359	2,5	MR CI 280 - 80 × 660 315 S	4 15,8
	95,1	10602	1,32	MR CI 225 - 75 × 550 315 S	* 4 14,7
	99,4	10148	2,24	MR CI 250 - 80 × 660 315 S	4 14,1
	109	9250	1,32	MR CI 225 - 75 × 550 315 S	* 4 12,8
	111	9087	2,36	MR CI 250 - 80 × 660 315 S	4 12,6
	121	8330	1,32	MR CI 225 - 75 × 550 315 S	* 4 11,6
	123	8214	2,36	MR CI 250 - 80 × 660 315 S	4 11,4
140	7216	1,32	MR CI 225 - 75 × 550 315 S	* 4 10	
135	7465	2,36	MR CI 250 - 80 × 660 315 S	4 10,4	
132	15,3	77348	0,9	MR C2I 360 - 80 × 660 315 M	4 91,4
	17,2	68754	1,06	MR C2I 360 - 80 × 660 315 M	4 81,2
	19,7	60160	0,95	MR C2I 321 - 80 × 660 315 M	4 71,1
	19,1	61879	1,12	MR C2I 360 - 80 × 660 315 M	4 73,1
	21,5	55113	1,06	MR C2I 321 - 80 × 660 315 M	4 65,1
	21,9	54210	1,32	MR C2I 360 - 80 × 660 315 M	4 64
	25	47434	0,95	MR C2I 320 - 80 × 660 315 M	4 56
	25	47434	1,18	MR C2I 321 - 80 × 660 315 M	4 56
	24,3	48789	1,5	MR C2I 360 - 80 × 660 315 M	4 57,6
	27,3	43423	1,06	MR C2I 320 - 80 × 660 315 M	4 51,3
	27,3	43423	1,32	MR C2I 321 - 80 × 660 315 M	4 51,3
	27,7	42711	1,6	MR C2I 360 - 80 × 660 315 M	4 50,5
	31,7	37372	1,18	MR C2I 320 - 80 × 660 315 M	4 44,2
	31,7	37372	1,5	MR C2I 321 - 80 × 660 315 M	4 44,2
	30,8	38440	1,8	MR C2I 360 - 80 × 660 315 M	4 45,4
	35,4	33457	1,32	MR C2I 320 - 80 × 660 315 M	4 39,5
	35,4	33457	1,7	MR C2I 321 - 80 × 660 315 M	4 39,5
	34,1	34703	2	MR C2I 360 - 80 × 660 315 M	4 41
	38,6	30698	1,5	MR C2I 320 - 80 × 660 315 M	4 36,3
	38,6	30698	1,8	MR C2I 321 - 80 × 660 315 M	4 36,3
	37,5	31575	2,24	MR C2I 360 - 80 × 660 315 M	4 37,3
	43,1	27482	1,6	MR C2I 320 - 80 × 660 315 M	4 32,5
	43,1	27482	2	MR C2I 321 - 80 × 660 315 M	4 32,5
	41,6	28506	2,24	MR C2I 360 - 80 × 660 315 M	4 33,7
	48,7	24334	1,8	MR C2I 320 - 80 × 660 315 M	4 28,8
	48,7	24334	2,36	MR C2I 321 - 80 × 660 315 M	4 28,8
	47,3	25029	2,8	MR C2I 360 - 80 × 660 315 M	4 29,6
55,2	21943	0,9	MR CI 250 - 80 × 660 315 M	4 25,4	
54,4	21785	2,12	MR C2I 320 - 80 × 660 315 M	4 25,7	
54,4	21785	2,65	MR C2I 321 - 80 × 660 315 M	4 25,7	
52,4	22596	3	MR C2I 360 - 80 × 660 315 M	4 26,7	
62,7	19305	0,9	MR CI 250 - 80 × 660 315 M	4 22,3	
68,9	17554	1,18	MR CI 250 - 80 × 660 315 M	4 20,3	
70	17288	1,5	MR CI 280 - 80 × 660 315 M	4 20	
78,4	15444	1,4	MR CI 250 - 80 × 660 315 M	4 17,9	
77,8	15559	1,5	MR CI 280 - 80 × 660 315 M	4 18	
87,5	13831	1,4	MR CI 250 - 80 × 660 315 M	4 16	
88,8	13631	2,12	MR CI 280 - 80 × 660 315 M	4 15,8	
99,4	12177	1,9	MR CI 250 - 80 × 660 315 M	4 14,1	
98,6	12268	2,24	MR CI 280 - 80 × 660 315 M	4 14,2	

1) Powers valid for continuous duty S1; **increase possible** for duty cycles S2 ... S10 (see ch. 1 «General specifications»); in which case M_2 increases and f_s decreases.

2) For complete designation when ordering see ch. 2.

* Mounting position **B5R** (see ch. 1.2).

13 - Selection tables (bevel helical gearmotors)

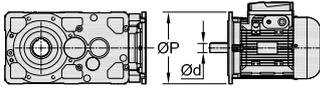

P_1	n_2	M_2	f_s		i	
kW	min ⁻¹	N m				
1)				2)		
132	111	10905	2	MR CI 250 - 80 × 660 315 M	4	12,6
	109	11115	2,24	MR CI 280 - 80 × 660 315 M	4	12,9
	123	9856	2	MR CI 250 - 80 × 660 315 M	4	11,4
	122	9931	2,24	MR CI 280 - 80 × 660 315 M	4	11,5
	135	8958	2	MR CI 250 - 80 × 660 315 M	4	10,4
	139	8690	2,24	MR CI 280 - 80 × 660 315 M	4	10,1
160	17,2	83338	0,9	MR C2I 360 - 80 × 660 315 MC	4	81,2
	19,1	75004	0,95	MR C2I 360 - 80 × 660 315 MC	4	73,1
	21,9	65709	1,12	MR C2I 360 - 80 × 660 315 MC	4	64
	25	57495	0,95	MR C2I 321 - 80 × 660 315 MC	4	56
	24,3	59138	1,18	MR C2I 360 - 80 × 660 315 MC	4	57,6
	27,3	52633	0,9	MR C2I 320 - 80 × 660 315 MC	4	51,3
	27,3	52633	1,12	MR C2I 321 - 80 × 660 315 MC	4	51,3
	27,7	51771	1,32	MR C2I 360 - 80 × 660 315 MC	4	50,5
	31,7	45299	1	MR C2I 320 - 80 × 660 315 MC	4	44,2
	31,7	45299	1,25	MR C2I 321 - 80 × 660 315 MC	4	44,2
	30,8	46594	1,5	MR C2I 360 - 80 × 660 315 MC	4	45,4
	35,4	40554	1,12	MR C2I 320 - 80 × 660 315 MC	4	39,5
	35,4	40554	1,4	MR C2I 321 - 80 × 660 315 MC	4	39,5
	34,1	42064	1,7	MR C2I 360 - 80 × 660 315 MC	4	41

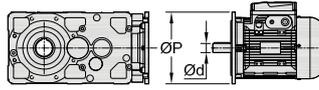
P_1	n_2	M_2	f_s		i	
kW	min ⁻¹	N m				
1)				2)		
160	38,6	37210	1,18	MR C2I 320 - 80 × 660 315 MC	4	36,3
	38,6	37210	1,5	MR C2I 321 - 80 × 660 315 MC	4	36,3
	37,5	38273	1,9	MR C2I 360 - 80 × 660 315 MC	4	37,3
	43,1	33312	1,32	MR C2I 320 - 80 × 660 315 MC	4	32,5
	43,1	33312	1,7	MR C2I 321 - 80 × 660 315 MC	4	32,5
	41,6	34552	1,9	MR C2I 360 - 80 × 660 315 MC	4	33,7
	48,7	29496	1,5	MR C2I 320 - 80 × 660 315 MC	4	28,8
	48,7	29496	1,9	MR C2I 321 - 80 × 660 315 MC	4	28,8
	47,3	30339	2,36	MR C2I 360 - 80 × 660 315 MC	4	29,6
	54,4	26406	1,7	MR C2I 320 - 80 × 660 315 MC	4	25,7
	54,4	26406	2,12	MR C2I 321 - 80 × 660 315 MC	4	25,7
	52,4	27389	2,5	MR C2I 360 - 80 × 660 315 MC	4	26,7
	70	20955	1,25	MR CI 280 - 80 × 660 315 MC	4	20
	77,8	18860	1,25	MR CI 280 - 80 × 660 315 MC	4	18
	88,8	16523	1,7	MR CI 280 - 80 × 660 315 MC	4	15,8
	98,6	14870	1,9	MR CI 280 - 80 × 660 315 MC	4	14,2
	109	13472	1,9	MR CI 280 - 80 × 660 315 MC	4	12,9
	122	12038	1,9	MR CI 280 - 80 × 660 315 MC	4	11,5
	139	10533	1,9	MR CI 280 - 80 × 660 315 MC	4	10,1

1) Powers valid for continuous duty S1; **increase possible** for duty cycles S2 ... S10 (see ch. 1 «General specifications»); in which case M_2 increases and f_s decreases.

2) For complete designation when ordering see ch. 2.

This page is intentionally left blank.

14 – Dimensions, designs, mounting positions (bevel helical gearmotors)

14.1 - Gearmotors MR CI	278
Dimensions	278
Designs (direction of rotation)	280
Mounting positions.....	281
Lubrication details	282
14.2 - Gearmotors MR ICI	283
Dimensions	283
Designs (direction of rotation)	284
Mounting positions.....	284
Lubrication details	285
14.3 - Gearmotors MR C3I	286
Dimensions	286
Designs (direction of rotation)	286
Mounting positions.....	287
Lubrication details	288
14.4 - Gearmotors MR C2I	289
Dimensions	289
Designs (direction of rotation)	290
Mounting positions.....	291
Lubrication details	292

14 - Dimensions, designs, mounting positions (bevel helical gearmotors)

14.1 - Gearmotors MR CI

Dimensions

MR CI 40 ... 100

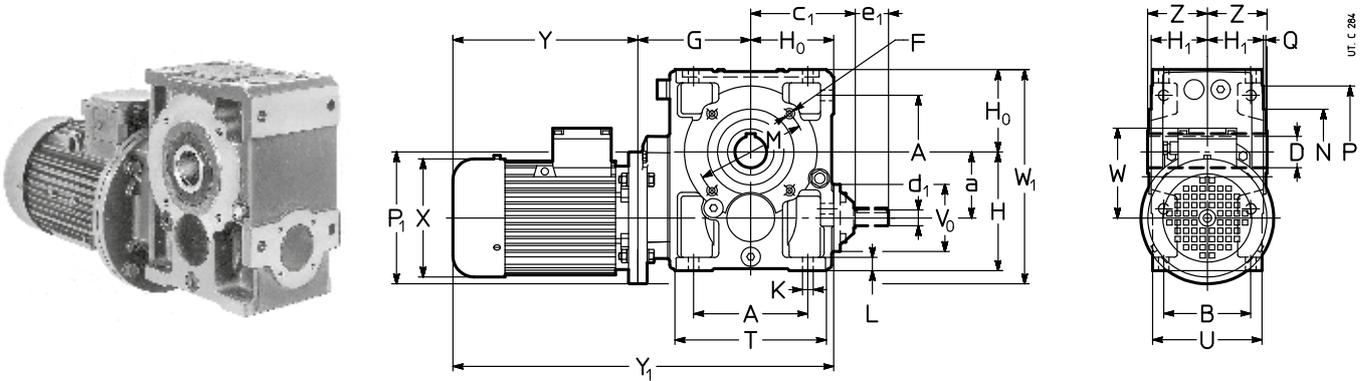

Size	a	A	c ₁	D	d ₁	e ₁	d ₁	e ₁	F	G	H	H ₀	H ₁	K	L	M	N	P	Q	T	V ₀	Z	P ₁	X	Y	Y ₁	W	W ₁	kg						
Gear red.	B5		B		i _N ≤ 12,5		i _N ≥ 16		1)										U				2)		2)		2)								
40	63	71	41,5	73 65	74	19	11	23	11	23	M5	87	82	56	41,5	7	10	75	60	90	2,5	102 80	43	46	140 160	123 138	189 216	244 278	332 359	387 421	95	168 192	12	14 17	
50	63	71 80	50	86 75	94	24	16	30	14	30	M6	98	100	67	49	9,5	12	85	70	105	2,5	120 95	78	53	140 160 200 ³⁾	123 138 156	189 216 233	244 278 302	354 381 398	409 443 467	95	187 197 221	16	18 21 27	
63	71	80	63	102 90	108	30	16	30	14	30	M8	118	125	80	58,5	11,5	14	100	80	120	3	143 114	78	63	160 200 200	138 156 176	216 233 287	278 302 366	414 431 485	476 500 564	112	223 243 243	23	26 32 40	
80	80	90	80	132 106	131	38	19	40	16	30	M10	138	150	100	69,5	14	17	130	110	160	3,5	180 135	86	75	200 200 250	156 176 194	233 287 310	302 366 405	471 525 558	540 604 653	121	280 280 305	39	43 51 56	
100	90	100	100	172 131	157	48	24	50	19	40	M12	170	180	125	84,5	16	20	165	130	200	3,5	228 165	104	90	200 250 250 300	176 194 218	287 310 336	366 405 435	582 605 631	661 700 730	141	325 350 350	65	71 76 91	
		112										190																							
		132 ⁵⁾																																	

1) Working length of thread 2 · F.
 2) Values valid for brake motor.
 3) On request and with price addition, dimension P₁ = 160: consult us.
 4) Mounting position **B5R** (see ch. 1.2).
 5) On request for 100LB 4, 112M 4 and 132M 4 also mounting position **B5R** (see ch. 1.2; dimensions Y and Y₂ increase by 27 mm, 26 mm and 35 mm, respectively).



14 - Dimensions, designs, mounting positions (bevel helical gearmotors)

MR CI 125 ... 280

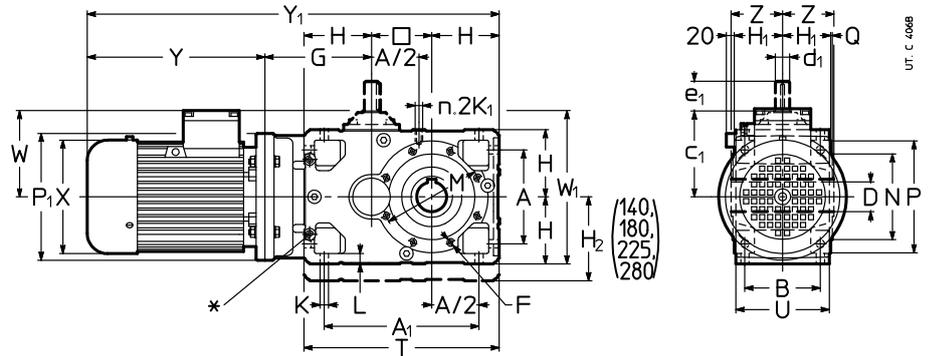
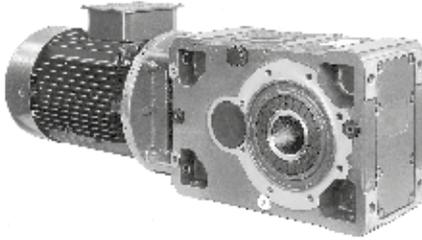

Size	G.red.		Motor		a	A	A ₁	c ₁	D Ø H7	d ₁ Ø		e ₁		F	G	H	H ₁	H ₂	K Ø	K ₁ L	M Ø	N Ø h6		P Ø	T	Z	P ₁ Ø	X ≈		Y ≈		Y ₁ ≈		W ≈	W ₁ ≈	kg
	B5	B	B	B						i _N ≤ 14	i _N ≥ 16	1)	2)									Q	U					3)	3)	3)						
125	132	125	212	337	188	60	28	60	24	50	4)	220	150	103,5	-	18	M12	215	180	250	425	110	300	257	445	553	940	1048	194	344	165	177				
	160 180	125 162	212 162	337	188	60	28	60	24	50	4)	220 250	150	103,5	-	18 23	M12	215	180 4	250	425 201	110	300 350 350	257 315 354	445 539 613	553 640 734	940 1064 1138	1048 1165 1259	194 241 278	344 450 453	165 211 270	177 216 260				
140	132	140	212	352	188	70	28	60	24	50	4)	220	150	103,5	180	18	M12	265	230	300	440	125	300	257	445	553	955	1063	194	470	178	190				
	160 180 200 ⁶⁾ 225 ⁶⁾	140 162	212 162	352	188	70	28	60	24	50	4)	220 250	150	103,5	180	18 23	M12	265	230 4	300	440 201	125	300 350 350	257 315 354	445 539 613	553 640 734	955 1079 1153	1063 1180 1274	194 241 278	470 495 495	178 224 283	190 229 273 297				
160	160	160	252	412	226	80	38	80	32	80	M16	282	180	128,5	-	22	M16	265	230	300	520	136	350	315	539	640	1161	1262	241	515	280	285				
	180 200 225 250	160 201	252 201	412	226	80	38	80	32	80	M16	282	180	128,5	-	22 28	M16	265	230 4	300	520 249	136	350 350 400 450	315 354 613 710	539 640 734 1276	640 734 1276 1362	1161 1235 1356 1276	1262 1356 1276 298	241 278 278 298	515 515 540 565	280 339 365 456	285 329 353 -				
180	180	180	252	432	226	90	38	80	32	80	M16	282	180	128,5	225	22	M16	300	250	350	540	150	350	354	613	734	1255	1376	278	580	362	352				
	200 225 250 ⁶⁾	180 201	252 201	432	226	90	38	80	32	80	M16	282	180	128,5	225	22 28	M16	300	250 5	350	540 249	150	350 400 450 450	354 354 613 710	613 654 734 -	734 734 -	1255 1296 1382 1382	1376 1376 -	278 278 298 298	580 605 630 630	362 388 479 502	352 376 -				
200	180	200	320	520	282	100	48	110	38	80	4)	325	225	158	-	27	M20	350	300	400	650	167	350	354	613	734	1363	1484	278	600	463	453				
	200 225 250 280	200 250	320 250	520	282	100	48	110	38	80	4)	325 355	225	158	-	27 34	M20	350	300 5	400	650 307	167	350 400 450 550 550	354 354 613 710 819	613 654 734 -	734 734 -	1363 1404 1484 1515 1599	1484 1484 -	278 278 298 298 360	600 625 650 700 700	463 489 580 603 789	453 477 -				
225	225	225	320	545	282	110	48	110	38	80	M20	355	225	158	280	27	M20	400	350	450	675	180	450	411	710	-	1515	-	298	730	622	-				
	250 280 315 ⁶⁾	225 250	320 250	545	282	110	48	110	38	80	M20	355	225	158	280	27 34	M20	400	350 5	450	675 307	180	450 550 550 550	411 411 490 490	710 735 819 820	- -	1515 1540 1624 1625	- -	298 298 360 360	730 780 780 780	622 645 831 792	-				
250	225	250	396	646	357	125	55	110	48	110	4)	410	280	195	-	33	M24	500	450	550	810	206	450	411	710	-	1650	-	298	755	853	-				
	250 280 315	250 310	396 310	646	357	125	55	110	48	110	4)	410 440	280	195	-	33 42	M24	500	450 5	550	810 380	206	450 550 550 660	411 411 490 604	710 735 819 962	- -	1650 1675 1759 1932	- -	298 298 360 445	755 805 805 860	853 816 1006 1254	-				
280	280	280	396	676	357	140	55	110	48	110	M24	410	280	195	355	33	M24	500	450	550	840	222	550	490	819	-	1789	-	360	870	1079	-				
	315	280 310	396 310	676	357	140	55	110	48	110	M24	410 440	280	195	355	33 42	M24	500	450 5	550	840 380	222	550 660	490 604	819 962	- -	1789 1962	- -	360 445	870 925	1079 1327	-				

* Machined surface and N. 2 threaded holes (dimensions in ch. 6 «Gear reducer input face») on opposite side (not in view) too.

- 1) Working length of thread 2 · F.
- 2) Working length of thread 2 · K₁.
- 3) Values valid for brake motor.
- 4) For dimension, number and angular position see ch. 6.
- 6) Mounting position B5R (see ch. 1.2).



14 - Dimensions, designs, mounting positions (bevel helical gearmotors)

Designs¹⁾ (direction of rotation)

MR CI 40 ... 100

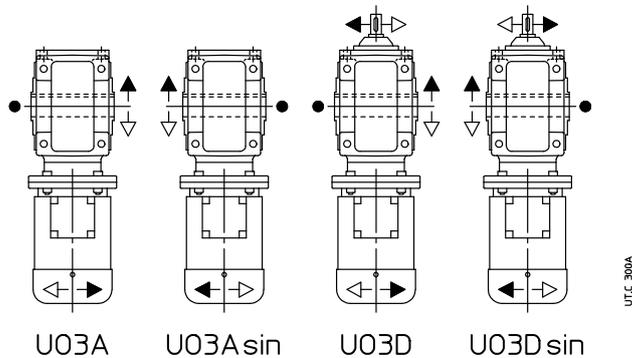

MR CI 125 ... 280

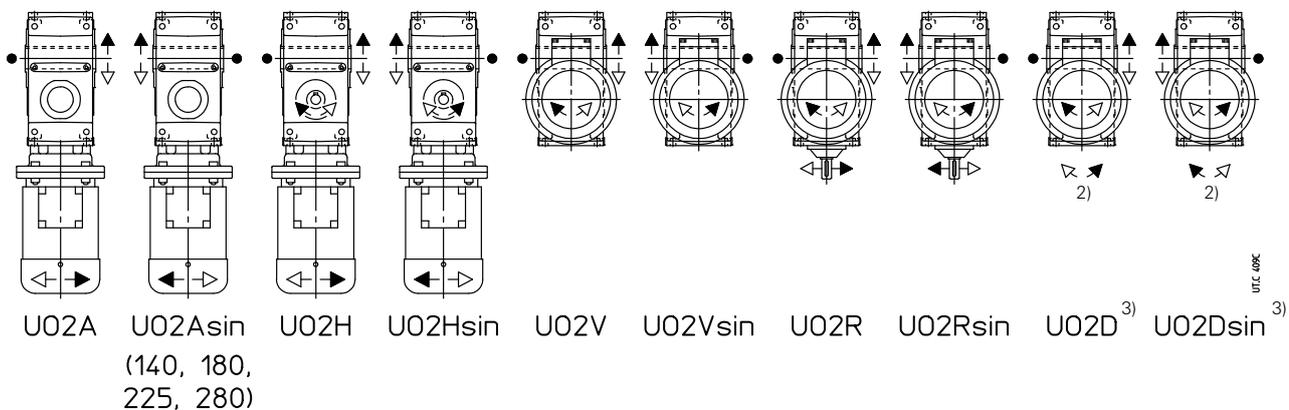

● Position of reference groove (see ch. 6) for radial load verification.

1) For motor design see ch. 2.

2) Direction of rotation of high speed shaft extension not in view.

3) Design **not possible** for sizes 140, 180, 225 and 280.

14 - Dimensions, designs, mounting positions (bevel helical gearmotors)

Mounting positions

Unless otherwise stated, gear reducers are supplied in mounting position **B3** (see ch. 2).

MR CI 40 ... 100

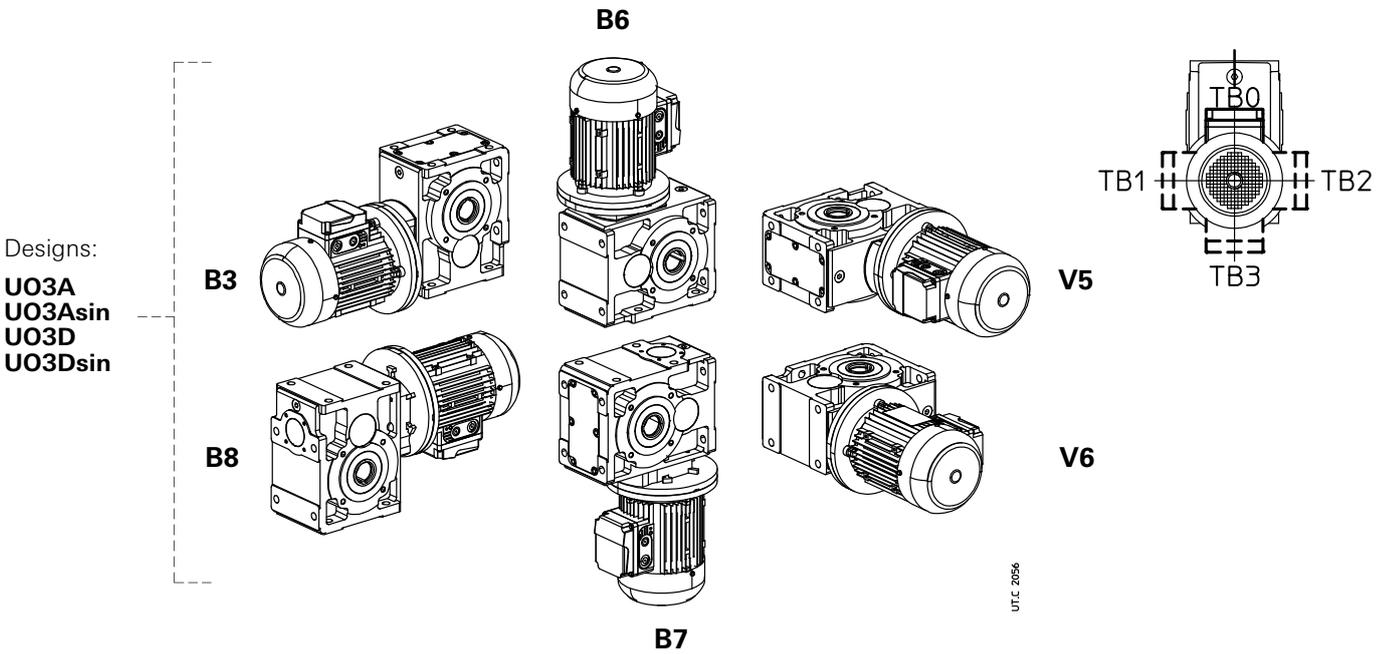

MR CI 125 ... 280

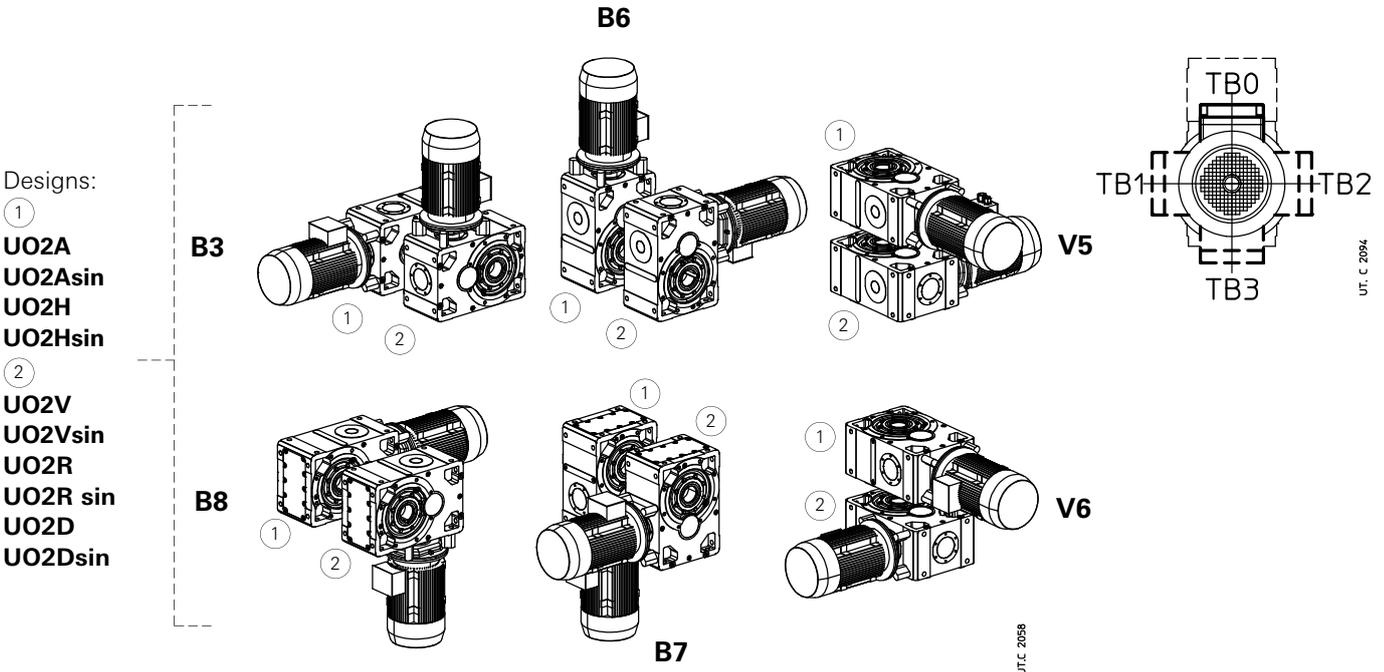

Oil quantity MR CI 40 ... 280

Lubricant quantities [l] stated are approximate for provisioning. The exact oil quantity the gear reducer is to be filled with is defined by the level plug.

Mounting position	40	50	63, 64	80, 81	100	125	140	160	180	200	225	250	280
B3	0,26	0,4	0,8	1,3	2,6	5,3	8,2	10,5	16,1	20,5	31,5	40	61
B8	0,35	0,6	1	2	3,8	5,3	5,5	10,5	10,7	20,5	21	40	41
B6	0,26	0,4	0,8	1,3	2,9	7	8,7	13,7	17	26,7	33,3	52	65
B7	0,26	0,4	0,8	1,3	2,9	7,6	9,7	15	19	29	37	57	72
V5	0,3	0,45	0,95	1,8	3,5	8,9	10,3	17,5	20,1	34	39,3	67	77
V6	0,3	0,45	0,95	1,8	3,5	8,9	10,3	17,5	20,1	34	39,3	67	77

14 - Dimensions, designs, mounting positions (bevel helical gearmotors)

Lubrication details

MR CI 100

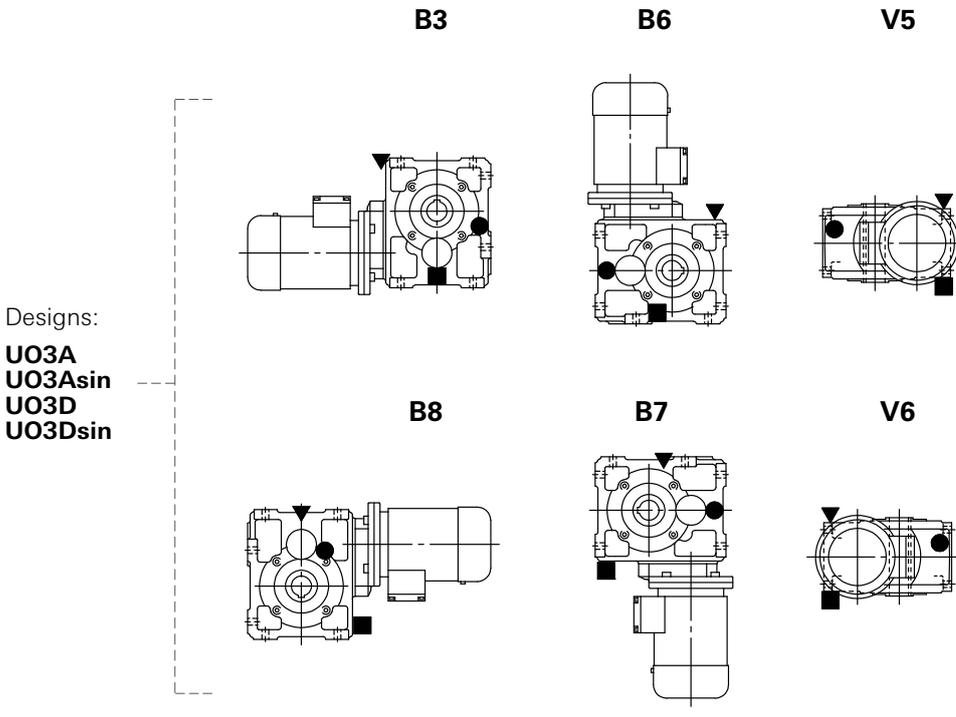

MR CI 125 ... 280

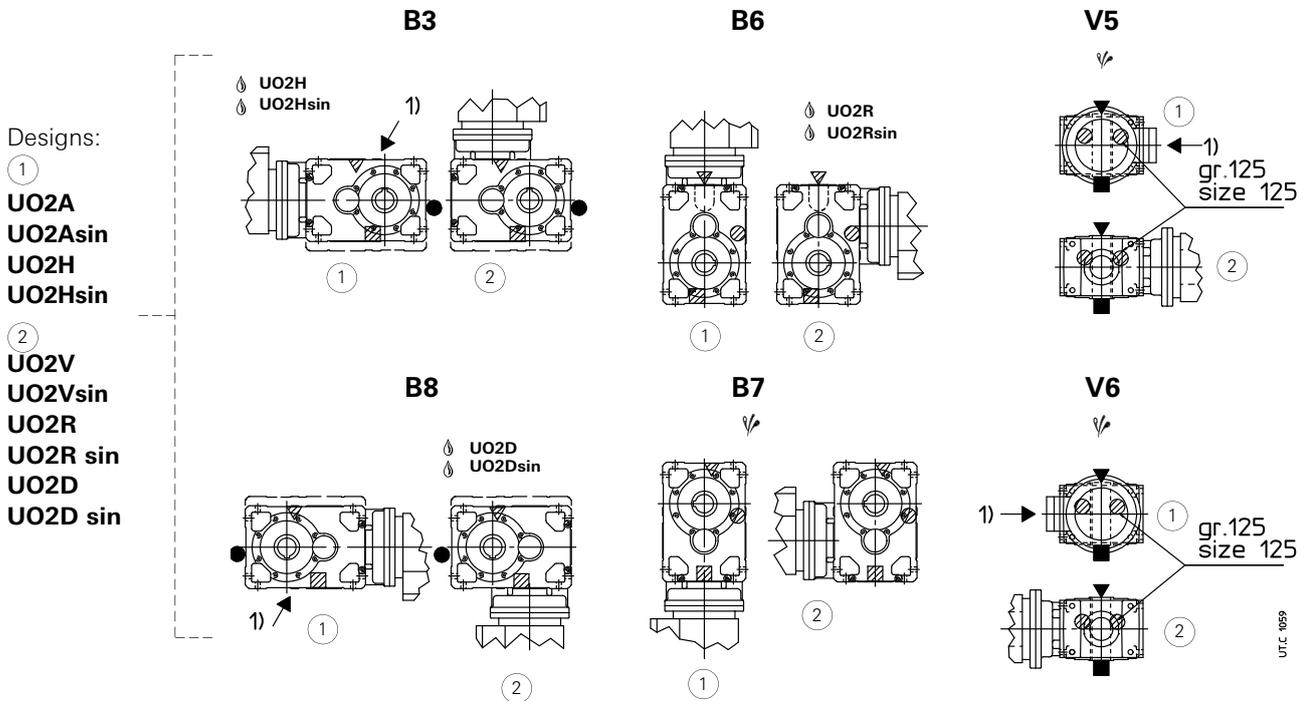

▽ Possible high oil splash: for the corrective factor ft_3 of nominal thermal power P_{tN} see ch. 4.

⊿ Possible bearing lubrication pump (see ch. 17 (19)).

1) Threaded hole position for mounting position individuation.

▼ oil filler plug
 ● oil level plug
 ■ oil drain plug

▽ oil filler plug on opposite side (not in view)
 ● oil level plug on opposite side (not in view)
 ■ oil drain plug on opposite side (not in view)

14 - Dimensions, designs, mounting positions (bevel helical gearmotors)

14.2 - Gearmotors MR ICI

Dimensions

MR ICI 40 ... 200

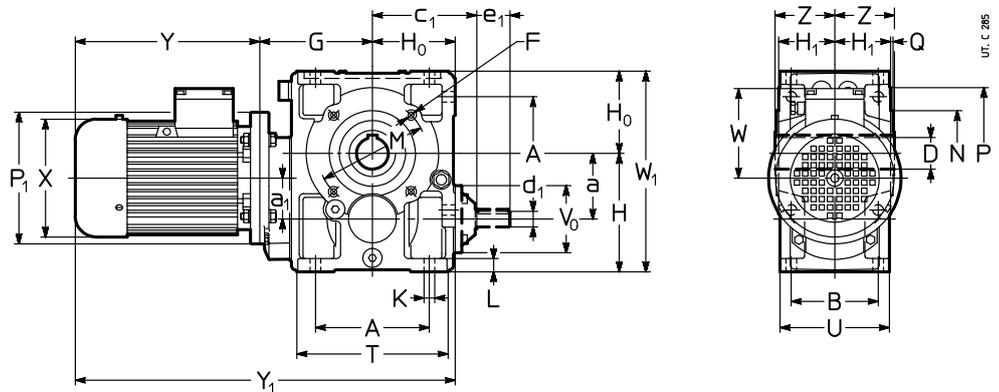
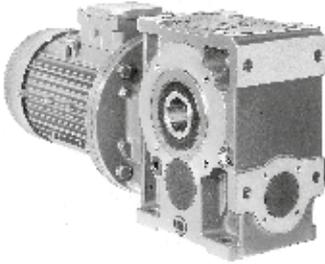

Size	a	A	c ₁	D Ø H7	d ₁ Ø	e ₁	d ₂ Ø	e ₂ Ø	F	G	H	H ₀	H ₁	K	L	M	N	P	Q	T	V ₀ Ø	Z	P ₁ Ø	X Ø	Y	Y ₁	W	W ₁	kg					
																														Motor red.	B5	a ₁	B	i _N ≤ 25
40	63	71	41,5	73	74	19	11	23	11	23	M5	87	82	56	41,5	7	10	75	60	90	2,5	102	43	46	140	123	189	244	332	387	95	176	12	14
	71	80	40	65	65																	80	80	138	216	278	359	421	112	193	14	17		
50	63	71	50	86	94	24	16	30	14 ⁵⁾	30 ⁵⁾	M6	98	100	67	49	9,5	12	85	70	105	2,5	120	78	53	140	123	189	244	354	409	95	185	16	18
	71	80	40	75	75																	95	95	156	233	302	381	443	112	202	18	21		
63	71	80	63	102	108	30	16	30	14 ⁵⁾	30 ⁵⁾	M8	118	125	80	58,5	11,5	14	100	80	120	3	143	78	63	160	138	216	278	414	476	112	224	23	26
	80	90	50	90	90	38 (63) 32 (64)	19	40	16 ⁵⁾	30 ⁵⁾	M10	138	150	100	69,5	14	17	130	110	160	3,5	180	86	75	200	156	233	302	431	500	121	233	28	32
80	71	80	80	132	131	38 (80) 40 (81)	19	40	16 ⁵⁾	30 ⁵⁾	M10	138	150	100	69,5	14	17	130	110	160	3,5	180	86	75	200	156	233	302	471	516	112	250	35	38
	81	100 ⁶⁾	50	106	106																	200	200	200	194	337	432	575	670	151	271	50	57	
100	80	90	100	172	157	48	24	50	19 ⁵⁾	40 ⁵⁾	M12	170	180	125	84,5	16	20	165	130	200	3,5	228	104	90	200	156	233	302	528	597	121	305	61	65
	112	125	62,5	131	131																	250	250	250	194	405	605	700	151	305	67	73		
125	90	100	125	212	188	60	28	60	24 ⁵⁾	50 ⁵⁾	4)	205	225	150	103,5	18	23	215	180	250	4	274	122	110	200	176	287	366	642	721	141	375	106	112
	112	132	80	162	162																	250	250	250	218	336	435	691	790	163	375	110	117	
140	90	100	140	212	188	70	28	60	24 ⁵⁾	50 ⁵⁾	4)	205	240	150	103,5	18	23	265	230	300	4	274	122	125	200	176	287	366	642	721	141	390	120	126
	112	160 ⁶⁾	80	162	162																	250	250	250	218	336	435	691	790	163	390	137	146	
160	100	112	160	252	226	80	38	80	32 ⁵⁾	80 ⁵⁾	4)	247	280	180	128,5	22	28	265	230	300	4	328	155	136	250	194	310	405	737	832	151	460	183	190
	132	180	100	201	201																	300	300	300	257	445	553	872	980	194	460	231	243	
180	112	132	180	252	226	90	38	80	32 ⁵⁾	80 ⁵⁾	4)	247	300	180	128,5	22	28	300	250	350	5	328	155	150	250	218	336	435	763	862	163	480	220	229
	160	200 ⁶⁾	100	201	201																	350	350	350	354	613	734	1053	1174	278	498	360	350	
200	132	160	200	320	282	100	48	110	38 ⁵⁾	80 ⁵⁾	4)	305	355	225	158	27	34	350	300	400	5	410	190	167	300	257	445	553	975	1083	194	580	362	374
	225	250	125	250	250																	450	450	450	411	710	-	1250	-	298	580	481	-	

1) Working length of thread 2 - F.

2) Values valid for brake motor.

4) For dimension, number and angular position, see ch. 6.

5) For the combined units – gear red. 50 with mot. 71, gear red. 63 ... 81 with mot. 80, gear red. 100 with mot. 90, gear red. 125 with mot. 100, 112, gear red. 140 with mot. 100, 112, 132, gear red. 160 with mot. 132, gear red. 180 with mot. 132 ... 180, gear red. 200 with mot. 160, 180 – having $i_N = 31,5$ (and $i_N = 40$ for gear red. 50 with mot. 63, for gear red. 140 with mot. 112 and for gear red. 180 with mot. 132) see column $i_N \leq 25$.

6) Mounting position **B5R** (see ch. 1.2).

7) On request and with price addition, dimension $P_1 = 160$: consult us.

8) For combined units with i_N final = 31,5 see column $i_N \leq 25$.



14 - Dimensions, designs, mounting positions (bevel helical gearmotors)

Designs¹⁾ (direction of rotation)

MR ICI 40 ... 200

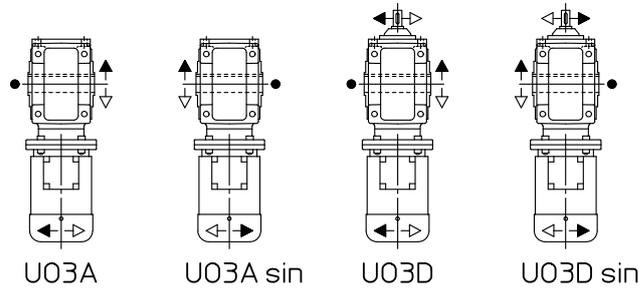

Mounting positions

Unless otherwise stated, gear reducers are supplied in mounting position **B3** (see ch. 2).

MR ICI 40 ... 200

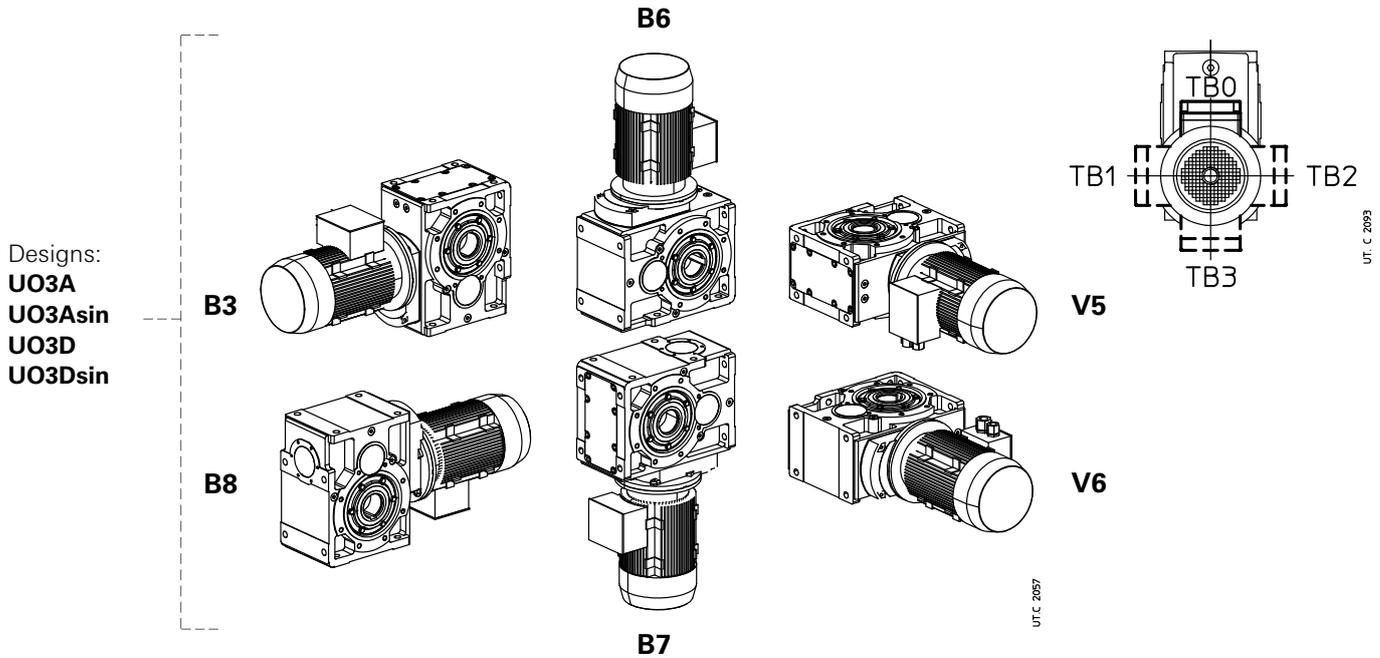

14

Oil quantity MR ICI 40 ... 200

Lubricant quantities [l] stated are approximate for provisioning. The exact oil quantity the gear reducer is to be filled with is defined by the level plug.

Mounting position	40	50	63, 64	80, 81	100	125	140	160	180	200
B3	0,31	0,45	1	1,6	3	6	6,8	10,6	11,9	20
B8	0,35	0,65	1,2	2,2	4,2	9	10,6	16	18,9	30
B7	0,31	0,45	1	1,6	3	6	6,8	10,6	11,9	20
B6	0,5	0,8	1,6	2,7	5,8	11,6	13,7	21	24,8	40
V5	0,3	0,5	1,15	2	3,8	7	8,3	13	15,3	24
V6	0,3	0,5	1,15	2	3,8	7	8,3	13	15,3	24

● Position of reference groove (see ch. 6) for radial load verification.
1) For motor design see ch. 2.

Lubrication details

MR ICI 100 ... 200

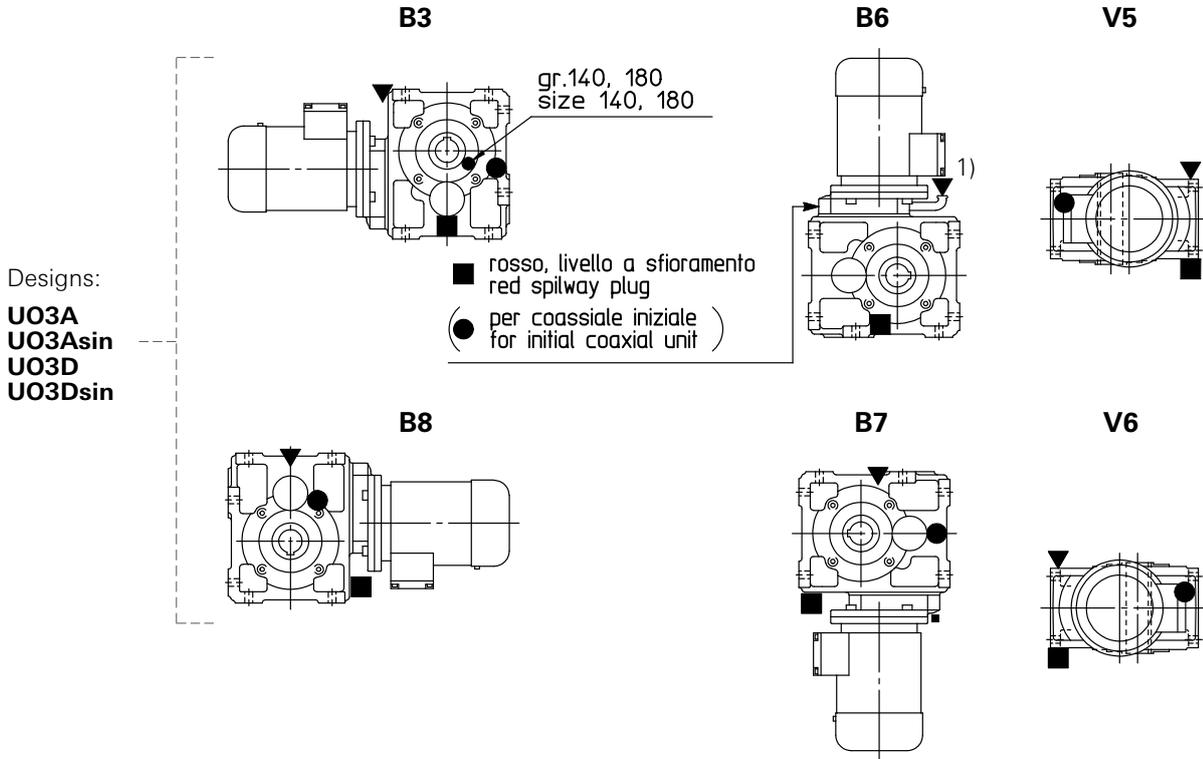

1) See also ch. 6 page 43.

- ▼ oil filler plug
- oil level plug
- oil drain plug
- ▼ oil filler plug on opposite side (not in view)
- oil level plug on opposite side (not in view)
- oil drain plug on opposite side (not in view)

14 - Dimensions, designs, mounting positions (bevel helical gearmotors)

14.3 - Gearmotors MR C3I

Dimensions

MR C3I 50 ... 125

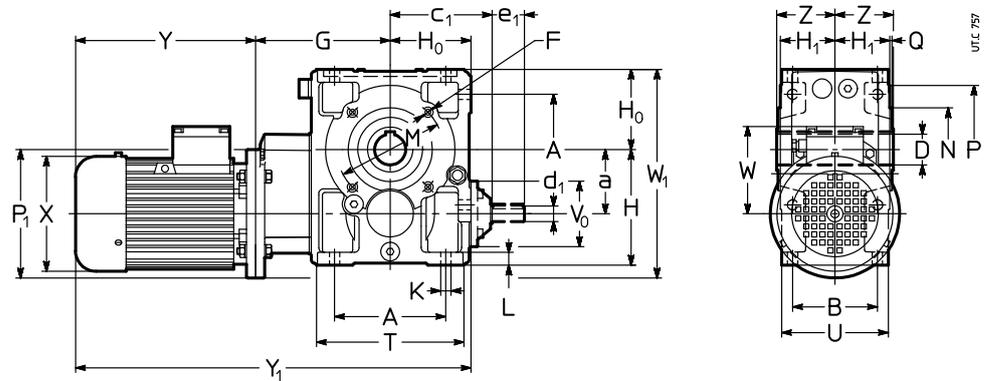
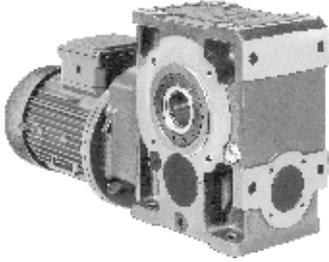

Size	a	A	c ₁	D Ø H7	d ₁ Ø	e ₁	d ₂ Ø	e ₂	F	G	H	H ₀	H ₁	K	L	M Ø	N Ø h6	P Ø	Q	T	V ₀ Ø	Z	P ₁ Ø	X Ø	Y	Y ₁	W	W ₁	kg				
Gear red.	Motor B5	B			i _N ≤ 125	i _N ≥ 160			1)		h11	h11	h12							U					2)	2)			2)				
50	63 71	50	86 75	94	24	16 ³⁾	30 ³⁾	14	30	M6	117	100	67	49	9,5	12	85	70	105	2,5	120 95	78	53	140 138	123 216	189 244	244 400	373 462	428 512	95 112	187 197	17 19	19 22
63 64	71 80	63	102 90	108	30 (63) 32 (64)	16 ³⁾	30 ³⁾	14	30	M8	145	125	80	58,5	11,5	14	100	80	120	3	143 114	78	63	160 200	138 156	216 233	278 302	441 458	503 527	112 121	223 243	24 29	27 33
80 81	71 80	80	132 106	131	38 (80) 40 (81)	19 ³⁾	40 ³⁾	16	30	M10	165	150	100	69,5	14	17	130	110	160	3,5	180 135	86	75	160 200	138 156	216 233	278 302	481 498	543 567	112 121	260 280	36 41	39 45
100	80 90	100	172 131	157	48	24 ³⁾	50 ³⁾	19	40	M12	203	180	125	84,5	16	20	165	130	200	3,5	228 165	104	90	200 200	156 176	233 287	302 366	561 615	630 694	121 141	325 325	63 69	67 75
125	90 100 112	125	212 162	188	60	28 ³⁾	60 ³⁾	24	50	4)	249	225	150	103,5	18	23	215	180	250	4	274 201	122	110	200 250 250	176 194 218	287 310 336	366 405 435	686 709 735	765 804 834	141 151 163	375 400 400	109 113 126	115 120 135

Designs⁵⁾ (direction of rotation)

MR C3I 50 ... 125

14

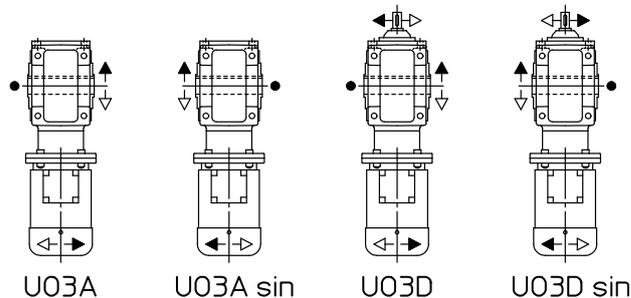

● Position of reference groove (see ch. 6) for radial load verification.

1) Working length for thread 2 · F.

2) Values valid for brake motor.

3) For gearmotor size 50 with motor 71, sizes 63, 64 with motor 80, sizes 80, 81 with motor 80, size 100 with motor 90, size 125 with motors 100, 112 and with i_N = 125, see d₁ for i_N ≥ 160.

4) For dimension, number and angular position see ch. 6.

5) For motor design see ch. 2.

14 - Dimensions, designs, mounting positions (bevel helical gearmotors)

Mounting positions

Unless otherwise stated, gear reducers are supplied in mounting position **B3** (see ch. 2).

MR C3I 50 ... 125

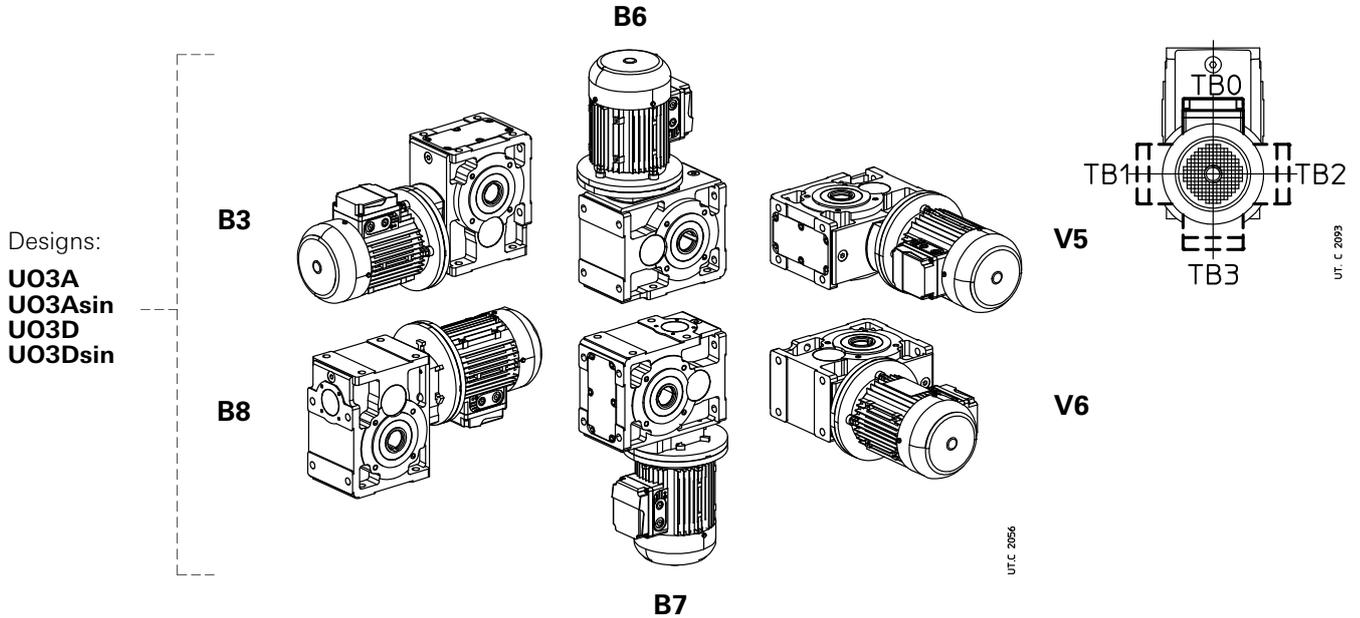

Oil quantity MR C3I 50 ... 125

Lubricant quantities [l] stated are approximate for provisioning. The exact oil quantity the gear reducer is to be filled with is defined by the level plug.

Mounting position	50	63, 64	80, 81	100	125
B3	0,5	1,2	1,9	3,3	6,4
B8	0,7	1,4	2,5	4,5	9,5
B7	0,5	1,2	1,9	3,3	6,4
B6	0,9	1,8	3	6,3	12,8
V5	0,55	1,35	2,3	4,1	7,5
V6	0,55	1,35	2,3	4,1	7,5

Lubrication details

MR C3I 100, 125

B3

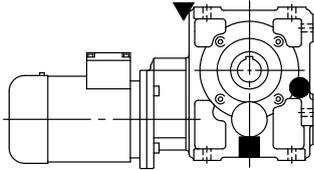

B6

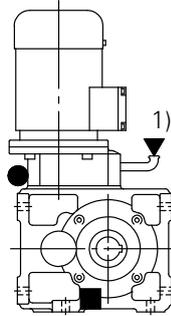

V5

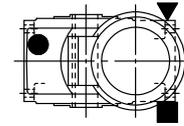

B8

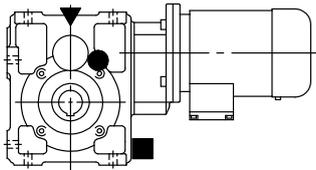

B7

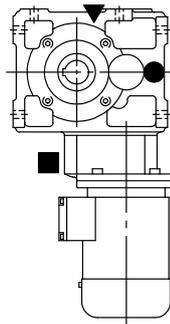

V6

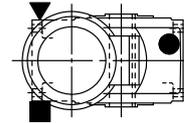

Designs:

- U03A**
- U03Asin**
- U03D**
- U03Dsin**

UT.C 1061A

1) See also ch. 6 page 43.

- ▼ oil filler plug
- oil level plug
- oil drain plug
- ▼ oil filler plug on opposite side (not in view)
- oil level plug on opposite side (not in view)
- oil drain plug on opposite side (not in view)

14 - Dimensions, designs, mounting positions (bevel helical gearmotors)

14.4 - Gearmotors MR C2I

Dimensions

MR C2I 140 ... 360

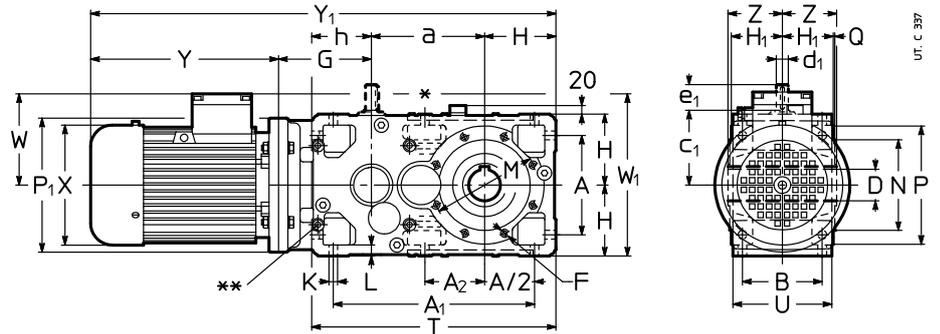
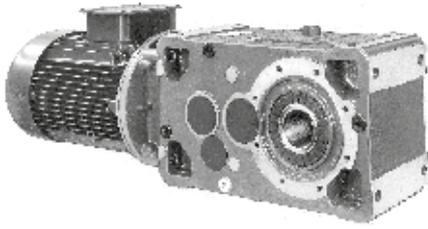

Size	a		A	A ₁	A ₂	c ₁	D	d ₁	e ₁	d ₁	e ₁	F	G	H	H ₁	h	K	L	M	N	P	T	Z	P ₁	X	Y	Y ₁	W	W ₁	kg			
	Motor	B5	B				∅ H7	∅	i _N ≤ 63	∅	i _N ≥ 71	1)	4)	h11	h12	h11	∅		∅	∅ h6	∅	∅	∅	∅	∅	∅	∅	∅	∅		∅		
140	100	240	212	427	127	157	70	24	50	19	40	5)	170	150	103,5	125	18	23	265	230	300	515	125	250	194	310	405	870	965	151	301	140	147
	112	240	212	427	127	157	70	24	50	19	40	5)	170	150	103,5	125	18	23	265	230	300	515	125	250	194	310	405	870	965	151	301	140	147
	132	240	212	427	127	157	70	24	50	19	40	5)	170	150	103,5	125	18	23	265	230	300	515	125	250	194	310	405	870	965	151	301	140	147
	160 ³⁾	240	212	427	127	157	70	24	50	19	40	5)	170	150	103,5	125	18	23	265	230	300	515	125	250	194	310	405	870	965	151	301	140	147
160	100	285	252	507	150*	188	80	28	60	24	50	M16	205	180	128,5	150	22	28	265	230	300	615	136	250	194	310	405	980	1075	151	360	211	218
	112	285	252	507	150*	188	80	28	60	24	50	M16	205	180	128,5	150	22	28	265	230	300	615	136	250	194	310	405	980	1075	151	360	211	218
	132	285	252	507	150*	188	80	28	60	24	50	M16	205	180	128,5	150	22	28	265	230	300	615	136	250	194	310	405	980	1075	151	360	211	218
	160	285	252	507	150*	188	80	28	60	24	50	M16	205	180	128,5	150	22	28	265	230	300	615	136	250	194	310	405	980	1075	151	360	211	218
180	100	305	252	527	170	188	90	28	60	24	50	M16	205	180	128,5	150	22	28	300	250	350	635	150	250	194	310	405	1000	1095	151	360	229	236
	112	305	252	527	170	188	90	28	60	24	50	M16	205	180	128,5	150	22	28	300	250	350	635	150	250	194	310	405	1000	1095	151	360	229	236
	132	305	252	527	170	188	90	28	60	24	50	M16	205	180	128,5	150	22	28	300	250	350	635	150	250	194	310	405	1000	1095	151	360	229	236
	160	305	252	527	170	188	90	28	60	24	50	M16	205	180	128,5	150	22	28	300	250	350	635	150	250	194	310	405	1000	1095	151	360	229	236
200	132	360	320	635	198*	226	100	38	80	32	80	5)	252	225	158	180	27	34	350	300	400	765	167	300	257	445	553	1282	1390	194	450	398	410
	160	360	320	635	198*	226	100	38	80	32	80	5)	252	225	158	180	27	34	350	300	400	765	167	300	257	445	553	1282	1390	194	450	398	410
	180	360	320	635	198*	226	100	38	80	32	80	5)	252	225	158	180	27	34	350	300	400	765	167	300	257	445	553	1282	1390	194	450	398	410
	200	360	320	635	198*	226	100	38	80	32	80	5)	252	225	158	180	27	34	350	300	400	765	167	300	257	445	553	1282	1390	194	450	398	410
225	132	385	320	660	223	226	110	38	80	32	80	M20	252	225	158	180	27	34	400	350	450	790	180	300	257	445	553	1307	1415	194	450	429	441
	160	385	320	660	223	226	110	38	80	32	80	M20	252	225	158	180	27	34	400	350	450	790	180	300	257	445	553	1307	1415	194	450	429	441
	180	385	320	660	223	226	110	38	80	32	80	M20	252	225	158	180	27	34	400	350	450	790	180	300	257	445	553	1307	1415	194	450	429	441
	200	385	320	660	223	226	110	38	80	32	80	M20	252	225	158	180	27	34	400	350	450	790	180	300	257	445	553	1307	1415	194	450	429	441
250	160	450	396	791	247*	282	125	48	110	38	80	5)	325	280	195	225	33	42	500	450	550	955	206	350	315	539	640	1594	1695	241	560	686	691
	180	450	396	791	247*	282	125	48	110	38	80	5)	325	280	195	225	33	42	500	450	550	955	206	350	315	539	640	1594	1695	241	560	686	691
	200	450	396	791	247*	282	125	48	110	38	80	5)	325	280	195	225	33	42	500	450	550	955	206	350	315	539	640	1594	1695	241	560	686	691
	225	450	396	791	247*	282	125	48	110	38	80	5)	325	280	195	225	33	42	500	450	550	955	206	350	315	539	640	1594	1695	241	560	686	691
280	160	480	396	821	277	282	140	48	110	38	80	M24	325	280	195	225	33	42	500	450	550	985	222	350	315	539	640	1624	1725	241	560	740	745
	180	480	396	821	277	282	140	48	110	38	80	M24	325	280	195	225	33	42	500	450	550	985	222	350	315	539	640	1624	1725	241	560	740	745
	200	480	396	821	277	282	140	48	110	38	80	M24	325	280	195	225	33	42	500	450	550	985	222	350	315	539	640	1624	1725	241	560	740	745
	225	480	396	821	277	282	140	48	110	38	80	M24	325	280	195	225	33	42	500	450	550	985	222	350	315	539	640	1624	1725	241	560	740	745
320	200	570	510	1005	318*	357 ⁶⁾	160	55 ⁷⁾	110 ⁷⁾	48	110	5)	380	355	241	280	39	52	600	550	660	1205	254	400	354	654	734	1959	2039	278	710	1199	1187
	225	570	510	1005	318*	357 ⁶⁾	160	55 ⁷⁾	110 ⁷⁾	48	110	5)	380	355	241	280	39	52	600	550	660	1205	254	400	354	654	734	1959	2039	278	710	1199	1187
	250	570	510	1005	318*	357 ⁶⁾	160	55 ⁷⁾	110 ⁷⁾	48	110	5)	380	355	241	280	39	52	600	550	660	1205	254	400	354	654	734	1959	2039	278	710	1199	1187
	280	570	510	1005	318*	357 ⁶⁾	160	55 ⁷⁾	110 ⁷⁾	48	110	5)	380	355	241	280	39	52	600	550	660	1205	254	400	354	654	734	1959	2039	278	710	1199	1187
360	200	610	510	1045	358	357 ⁶⁾	180	55 ⁷⁾	110 ⁷⁾	48	110	M30	380	355	241	280	39	52	600	550	660	1245	273	400	354	654	734	1999	2079	278	710	1294	1282
	225	610	510	1045	358	357 ⁶⁾	180	55 ⁷⁾	110 ⁷⁾	48	110	M30	380	355	241	280	39	52	600	550	660	1245	273	400	354	654	734	1999	2079	278	710	1294	1282
	250	610	510	1045	358	357 ⁶⁾	180	55 ⁷⁾	110 ⁷⁾	48	110	M30	380	355	241	280	39	52	600	550	660	1245	273	400	354	654	734	1999	2079	278	710	1294	1282
	280	610	510	1045	358	357 ⁶⁾	180	55 ⁷⁾	110 ⁷⁾	48	110	M30	380	355	241	280	39	52	600	550	660	1245	273	400	354	654	734	1999	2079	278	710	1294	1282

* Only No. 2 holes M 16 x 32 (size 160), M 20 x 38 (size 200), M 24 x 46 (size 250) and M 30 x 58 (size 320) and not for design UO2A.

** Machined surface and N. 4 threaded holes (dimensions in ch. 6 «Gear reducer input face») on opposite side (not in view) too.

1) Working length for thread 2 · F.

2) Values valid for brake motor.

3) Mounting position **B5R** (see ch. 1.2).

4) For designs ...**V**, ...**V sin**, ...**R**, ...**R sin**, sizes 140 ... 225, dimension **G** increases by 10 mm.

14 - Dimensions, designs, mounting positions (bevel helical gearmotors)

Designs¹⁾ (direction of rotation)

MR C2I 140 ... 360

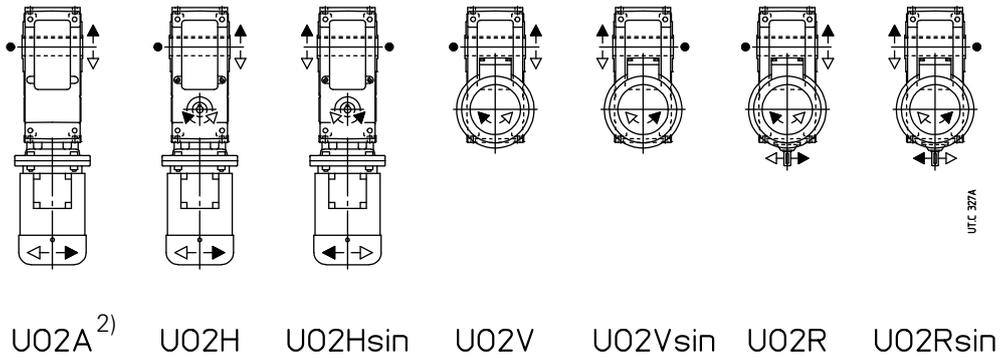

● Position of reference groove (see ch. 6) for radial load verification.

1) For motor design see ch. 2.

2) The housing of this design is not pre-arranged for other designs.

14 - Dimensions, designs, mounting positions (bevel helical gearmotors)

Mounting positions

Unless otherwise stated, gear reducers are supplied in mounting position **B3** (see ch. 2).

MR C2I 140 ... 360

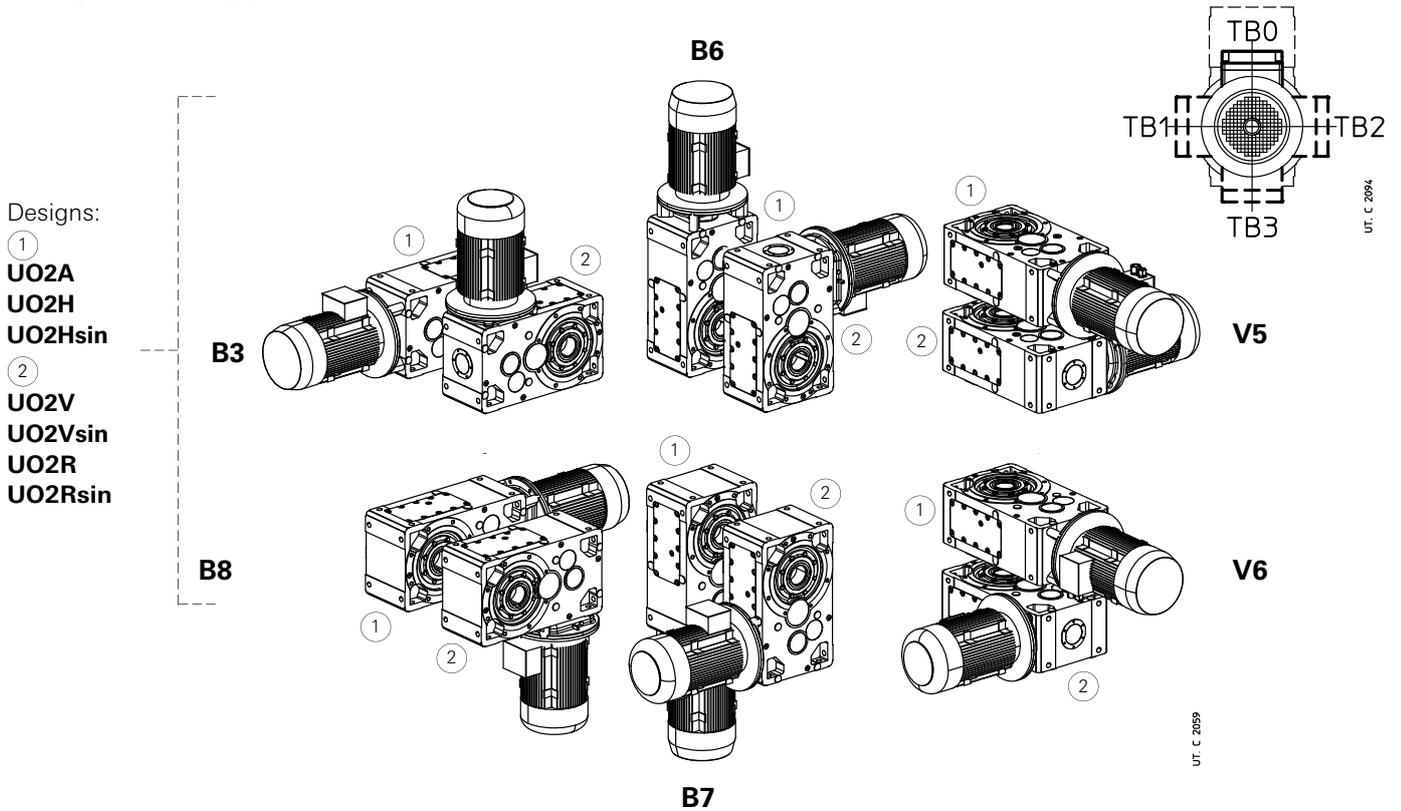

Oil quantity MR C2I 140 ... 360

Lubricant quantities [l] stated are approximate for provisioning. The exact oil quantity the gear reducer is to be filled with is defined by the level plug.

Mounting position	140	160	180	200	225	250	280	320, 321	360
B3	6,6	12	13	25	26	47	51	97	100
B8	6,6	12	13	25	26	47	51	97	100
B7	9,7	18	19	35	37	67	72	137	140
B6	10,8	20	21	39	41	75	80	152	156
V5	9,7	18	19	35	37	67	72	137	140
V6	9,7	18	19	35	37	67	72	137	140

Lubrication details

MR C2I 140 ... 360

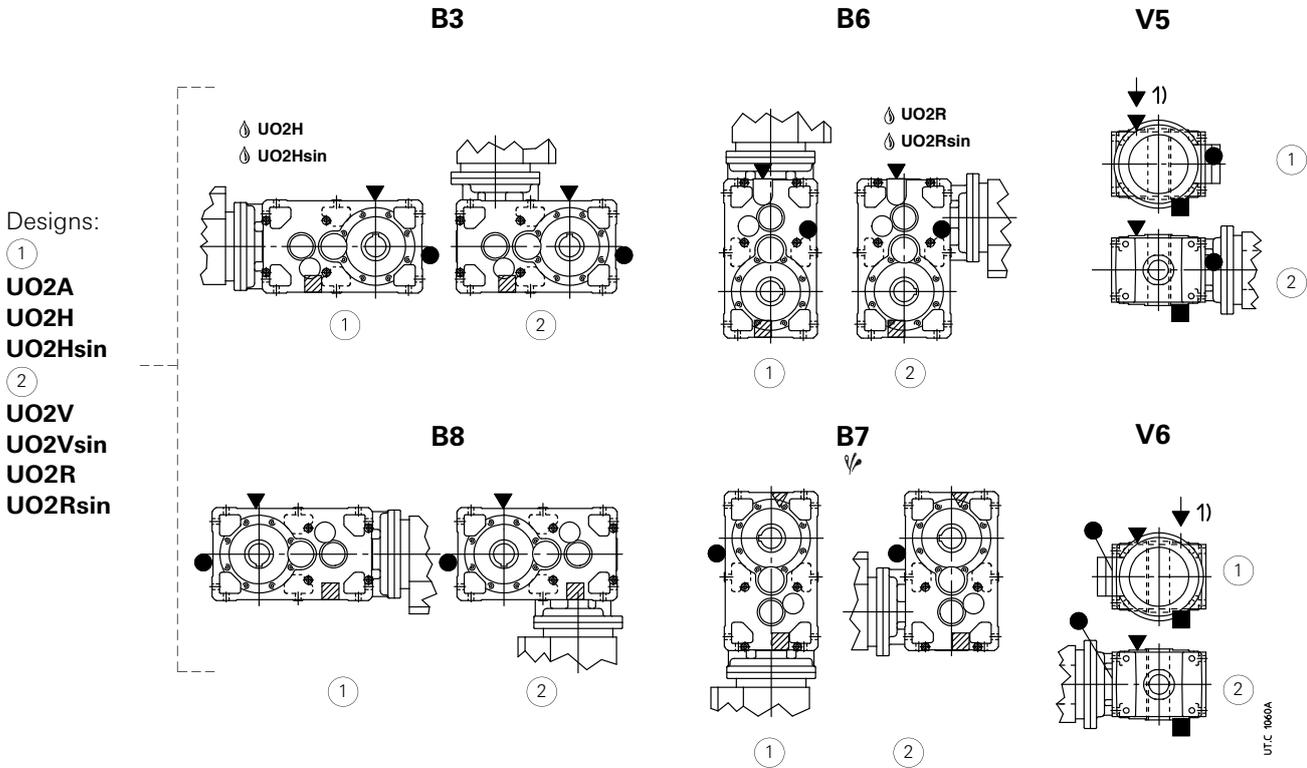

⚠ Possible high oil splash: for the corrective factor f_{t3} of nominal thermal power P_{tN} see ch. 4.

⚡ Possible bearing lubrication pump (see ch 17 (19)).

1) Position of intermediate hole for mounting position identification.

▼ oil filler plug

● oil level plug

■ oil drain plug

▼ oil drain plug on opposite side (not in view)

● oil level plug on opposite side (not in view)

■ oil drain plug on opposite side (not in view)

15 – Combined gear units

15 - Combined gear units

Final helical gear reducer

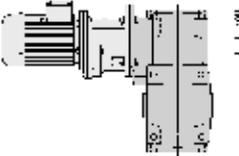
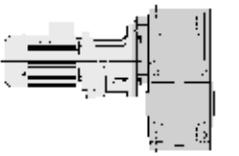
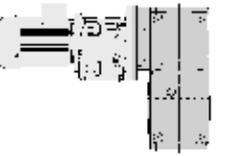
M_{N2} [N m] for $n_2 \leq 14 \text{ min}^{-1}$	MR 2I + MR 2I, 3I	MR 3I + MR 2I, 3I	MR 3I + MR 2I, 3I
	 $i_N \approx 80 \dots 2\,500$ $\eta_{\text{final}} = 0,96$	 $i_N \approx 160 \dots 8\,000$ $\eta_{\text{final}} = 0,94$	 $i_N \approx 125 \dots 12\,500$ $\eta_{\text{final}} = 0,94$
315	MR 2I 63 - 19x160 - 19,3 + MR 2I, 3I 40 $i_{\text{final}} = 19,3$	MR 3I 63 - 14x140 - 48,9 + MR 2I, 3I 32 $i_{\text{final}} = 48,9$	
400	MR 2I 64 - 19x160 - 20,1 + MR 2I, 3I 40 $i_{\text{final}} = 20,1$	MR 3I 64 - 14x140 - 50,9 + MR 2I, 3I 32 $i_{\text{final}} = 50,9$	
670	MR 2I 80 - 19x160 - 20,8 + MR 2I, 3I 40 $i_{\text{final}} = 20,8$	MR 3I 80 - 19x160 - 52,9 + MR 2I, 3I 40 $i_{\text{final}} = 52,9$	
780	MR 2I 81 - 19x160 - 20,8 + MR 2I, 3I 40 $i_{\text{final}} = 20,8$	MR 3I 81 - 19x160 - 52,9 + MR 2I, 3I 40 $i_{\text{final}} = 52,9$	
1 600	MR 2I 100 - 24x200 - 19,3 + MR 2I, 3I 50 ²⁾ $i_{\text{final}} = 19,3$	MR 3I 100 - 24x200 - 49 + MR 2I, 3I 50 ²⁾ $i_{\text{final}} = 49$	
3 150	MR 2I 125 - 28x250 - 19,3 + MR 2I, 3I 63 ²⁾ $i_{\text{final}} = 19,3$	MR 3I 125 - 24x200 - 60,2 + MR 2I, 3I 50 ²⁾ $i_{\text{final}} = 60,2$	
4 750			MR 3I 140 - 28x250 - 50,4 + MR 2I, 3I 63 ²⁾ $i_{\text{final}} = 50,4$
7 100			MR 3I 160 - 38x300 - 31,6 + MR 2I 80 ²⁾ $i_{\text{final}} = 31,6$ MR 3I 160 - 28x250 - 107 + MR 2I, 3I 63 ²⁾ $i_{\text{final}} = 107$ for $n_2 \leq 2,8 \text{ min}^{-1}$
9 500			MR 3I 180 - 38x300 - 51 + MR 2I 80 ²⁾ $i_{\text{final}} = 51$ MR 3I 180 - 28x250 - 108 + MR 2I, 3I 63 ²⁾ $i_{\text{final}} = 108$ for $n_2 \leq 2,8 \text{ min}^{-1}$
14 000			MR 3I 200 - 48x350 - 31,5 + MR 2I 100 ²⁾ $i_{\text{final}} = 31,5$ MR 3I 200 - 38x300 - 100 + MR 2I, 3I 80 ²⁾ $i_{\text{final}} = 100$ for $n_2 \leq 2,8 \text{ min}^{-1}$
20 000			MR 3I 225 - 48x350 - 51,8 + MR 2I 100 ²⁾ $i_{\text{final}} = 51,8$ MR 3I 225 - 38x300 - 98,5 + MR 2I, 3I 80 ²⁾ $i_{\text{final}} = 98,5$ for $n_2 \leq 2,8 \text{ min}^{-1}$
31 500			MR 3I 250 - 60x450 - 33,5 + MR 2I 125 ²⁾ $i_{\text{final}} = 33,5$ MR 3I 250 - 48x350 - 98,5 + MR 2I, 3I 100 ²⁾ $i_{\text{final}} = 98,5$ for $n_2 \leq 2,8 \text{ min}^{-1}$
37 500			MR 3I 280 - 60x450 - 52,7 + MR 2I 125 ²⁾ $i_{\text{final}} = 52,7$ MR 3I 280 - 48x350 - 100 + MR 2I, 3I 100 ²⁾ $i_{\text{final}} = 100$ for $n_2 \leq 2,8 \text{ min}^{-1}$
47 500			MR 3I 320 - 60x450 - 67,1 + MR 2I 125 ²⁾ $i_{\text{final}} = 67,1$ MR 3I 320 - 60x450 - 105 + MR 2I, 3I 125 ²⁾ $i_{\text{final}} = 105$ for $n_2 \leq 2,8 \text{ min}^{-1}$
60 000			MR 3I 321 - 60x450 - 67,1 + MR 2I 125 ²⁾ $i_{\text{final}} = 67,1$ MR 3I 321 - 60x450 - 105 + MR 2I, 3I 125 ²⁾ $i_{\text{final}} = 105$ for $n_2 \leq 2,8 \text{ min}^{-1}$
77 500			MR 3I 360 - 60x450 - 103 + MR 2I, 3I 125 ²⁾ $i_{\text{final}} = 103$

Initial gearmotor dimensions and performance: catalog E ch. 8, 9 and 10.

1) f_s required may be reduced by **1,06** for $n_2 = 2,8 \div 0,7 \text{ min}^{-1}$, by **1,12** for $n_2 \leq 0,71 \text{ min}^{-1}$, provided that it is always $\geq 0,8$.

2) Initial gearmotor design «Oversized B5 flange»; size 63 has a low speed shaft reduced to 28 mm: «Oversized B5 flange - Ø 28».

15 - Combined gear units

Final bevel helical gear reducer

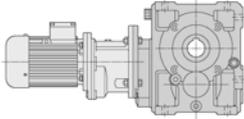
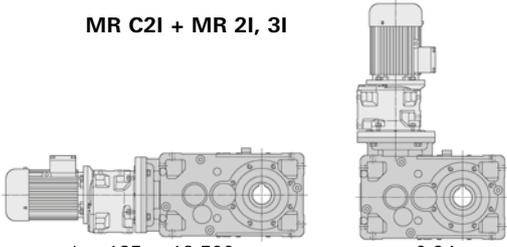
M_{N2} [N m] for $n_2 \leq 14 \text{ min}^{-1}$	MR ICI + MR 2I, 3I	MR C2I + MR 2I, 3I
	 $i_N \approx 125 \dots 8\,000$ $\eta_{\text{final}} = 0,94$	 $i_N \approx 125 \dots 12\,500$ $\eta_{\text{final}} = 0,94$
315	MR ICI 63 - 19x160 - 32 + MR 2I, 3I 40 $i_{\text{final}} = 32$	
400	MR ICI 64 - 19x160 - 32 + MR 2I, 3I 40 $i_{\text{final}} = 32$	
670	MR ICI 80 - 19x160 - 33,4 + MR 2I, 3I 40 $i_{\text{final}} = 33,4$	
780	MR ICI 81 - 19x160 - 33,4 + MR 2I, 3I 40 $i_{\text{final}} = 33,4$	
1 600	MR ICI 100 - 24x200 - 31,4 + MR 2I, 3I 50 ²⁾ $i_{\text{final}} = 31,4$	
3 150	MR ICI 125 - 28x250 - 32 + MR 2I, 3I 63 ²⁾ $i_{\text{final}} = 32$ MR ICI 125 - 24x200 - 62,5 + MR 2I, 3I 50 ²⁾ $i_{\text{final}} = 62,5$ for $M_{N2} \leq 2650 \text{ N m}$	
4 750	MR ICI 140 - 28x250 - 40 + MR 2I, 3I 63 ²⁾ $i_{\text{final}} = 40$ for $M_{N2} \leq 3750 \text{ N m}$	MR C2I 140 - 28x250 - 50,4 + MR 2I, 3I 63 ²⁾ $i_{\text{final}} = 50,4$
7 100	MR ICI 160 - 38x300 - 33,3 + MR 2I, 3I 80 ²⁾ $i_{\text{final}} = 33,3$ MR ICI 160 - 28x250 - 62,5 + MR 2I, 3I 63 ²⁾ $i_{\text{final}} = 62,5$ for $M_{N2} \leq 6000 \text{ N m}$	MR C2I 160 - 38x300 - 32,5 + MR 2I 80 ²⁾ $i_{\text{final}} = 32,5$ MR C2I 160 - 28x250 - 103 + MR 2I, 3I 63 ²⁾ $i_{\text{final}} = 103$ for $n_2 \leq 2,8 \text{ min}^{-1}$
9 500	MR ICI 180 - 38x300 - 40,9 + MR 2I, 3I 80 ²⁾ $i_{\text{final}} = 40,9$ for $M_{N2} \leq 8500 \text{ N m}$	MR C2I 180 - 38x300 - 52,4 + MR 2I 80 ²⁾ $i_{\text{final}} = 52,4$ MR C2I 180 - 28x250 - 104 + MR 2I, 3I 63 ²⁾ $i_{\text{final}} = 104$ for $n_2 \leq 2,8 \text{ min}^{-1}$
14 000	MR ICI 200 - 48x350 - 33,3 + MR 2I, 3I 100 ²⁾ $i_{\text{final}} = 33,3$ MR ICI 200 - 38x300 - 62,5 + MR 2I, 3I 80 ²⁾ $i_{\text{final}} = 62,5$ for $M_{N2} \leq 11800 \text{ N m}$	MR C2I 200 - 48x350 - 32,3 + MR 2I 100 ²⁾ $i_{\text{final}} = 32,3$ MR C2I 200 - 38x300 - 102 + MR 2I, 3I 80 ²⁾ $i_{\text{final}} = 102$ for $n_2 \leq 2,8 \text{ min}^{-1}$
20 000		MR C2I 225 - 48x350 - 53,1 + MR 2I 100 ²⁾ $i_{\text{final}} = 53,1$ MR C2I 225 - 38x300 - 100 + MR 2I, 3I 80 ²⁾ $i_{\text{final}} = 100$ for $n_2 \leq 2,8 \text{ min}^{-1}$
31 500		MR C2I 250 - 60x450 - 33,9 + MR 2I 125 ²⁾ $i_{\text{final}} = 33,9$ MR C2I 250 - 48x350 - 98,5 + MR 2I, 3I 100 ²⁾ $i_{\text{final}} = 98,5$ for $n_2 \leq 2,8 \text{ min}^{-1}$
37 500		MR C2I 280 - 60x450 - 53,1 + MR 2I 125 ²⁾ $i_{\text{final}} = 53,1$ MR C2I 280 - 48x360 - 100 + MR 2I, 3I 100 ²⁾ $i_{\text{final}} = 100$ for $n_2 \leq 2,8 \text{ min}^{-1}$
47 500		MR C2I 320 - 60x450 - 65,1 + MR 2I 125 ²⁾ $i_{\text{final}} = 65,1$ MR C2I 320 - 60x450 - 103 + MR 2I, 3I 125 ²⁾ $i_{\text{final}} = 103$ for $n_2 \leq 2,8 \text{ min}^{-1}$
60 000		MR C2I 321 - 60x450 - 65,1 + MR 2I 125 ²⁾ $i_{\text{final}} = 65,1$ MR C2I 321 - 60x450 - 103 + MR 2I, 3I 125 ²⁾ $i_{\text{final}} = 103$ for $n_2 \leq 2,8 \text{ min}^{-1}$
77 500		MR C2I 360 - 60x450 - 102 + MR 2I, 3I 125 ²⁾ $i_{\text{final}} = 102$

Initial gearmotor dimensions and performance: catalog E ch. 8, 9 and 10.

1) f_s required may be reduced by **1,06** for $n_2 = 2,8 \div 0,7 \text{ min}^{-1}$, by **1,12** for $n_2 \leq 0,71 \text{ min}^{-1}$, provided that it is always $\geq 0,8$.

2) Initial gearmotor size ≥ 50 design «Oversized B5 flange»; size 63 has low speed shaft reduced to 28 mm: «Oversized B5 flange - Ø 28».

15 - Combined gear units

Initial gearmotor mounting position

In order to make easier the individualization of the combined gearmotors mounting position refer to the following table where, according to the type, to the mounting position and to the final gear reducer, the mounting positions of the initial gearmotor are stated.

Initial **gearmotor** mounting position

	final gear reducer mounting position					
	B3	B6	B7	B8	V5	V6
MR 2I 63...125 + MR 2I, 3I	<p>$B5^* = 40^{1)}$ $B7 \geq 50$</p>	<p>$B5^* = 40$ $B3^* \geq 50$</p>	<p>$B5^* = 40$ $B3^* \geq 50$</p>	<p>$B5^* = 40^{1)}$ $B6 \geq 50$</p>	<p>$V1 = 40$ $V5 \geq 50$</p>	<p>$V3 = 40$ $V6 \geq 50$</p>
MR 3I 63...125 + MR 2I, 3I	<p>$B5^* \leq 40^{1)}$ $B7 \geq 50$</p>	<p>$B5^* \leq 40$ $B3^* \geq 50$</p>	<p>$B5^* \leq 40$ $B3^* \geq 50$</p>	<p>$B5^* \leq 40^{1)}$ $B6 \geq 50$</p>	<p>$V1 \leq 40$ $V5 \geq 50$</p>	<p>$V3 \leq 40$ $V6 \geq 50$</p>
MR 3I 140...360 + MR 2I, 3I	<p>B7</p>	<p>B3*</p>	<p>B3*</p>	<p>B6</p>	<p>V5</p>	<p>V6</p>
MR 1CI 63...200 + MR 2I, 3I	<p>$B5^* \leq 40$ $B3^* \geq 50$</p>	<p>$V1 \leq 40$ $V5 \geq 50$</p>	<p>$V3 \leq 40$ $V6 \geq 50$</p>	<p>$B5^* \leq 40$ $B3^* \geq 50$</p>	<p>$B5^* \leq 40^{1)}$ $B6 \geq 50$</p>	<p>$B5^* \leq 40^{1)}$ $B7 \geq 50$</p>
MR C2I 140...360 + MR 2I, 3I	<p>B3*</p>	<p>V5</p>	<p>V6</p>	<p>B3*</p>	<p>B7</p>	<p>B6</p>
	<p>V5</p>	<p>B3*</p>	<p>B3*</p>	<p>V6</p>	<p>B7</p>	<p>B6</p>

* This mounting position, being standard, must not be stated in the designation.

1) Grease quantity is the same foreseen for B3 mounting position in cat. E.

On name plate there is a * in correspondence of mounting position.

UTC 761

16 – Radial loads

16.1 - Radial loads F_{r1} [N] on high speed shaft end

Radial loads generated on the shaft end by a drive connecting gear reducer and motor must be less than or equal to those given in the relevant table.

n_1 min ⁻¹	50		63, 64				80, 81			100				125, 140				
	2I CI	ICI	I	2I CI	3I ICI	ICI	I	2I CI	3I ICI	I	2I CI	3I ICI		I	2I CI	3I C2I	3I 125 ICI	
												$i_k \leq 80$	$i_k \geq 100$				$i_k \leq 80$	$i_k \geq 100$
1800	300	150	750	475	150	236	1180	750	375	1900	1180	600	375	3000	1900	1180	950	600
1400	355	170	850	530	170	265	1320	850	425	2120	1320	670	425	3350	2120	1320	1060	670
1120	355	180	900	560	180	280	1400	900	450	2240	1400	710	450	3550	2240	1400	1120	710
900	375	190	950	600	190	300	1500	950	475	2360	1500	750	475	3750	2360	1500	1180	750
710	425	212	1060	670	212	335	1700	1060	530	2650	1700	850	530	4250	2650	1700	1320	850
560	450	224	1120	710	224	355	1800	1120	560	2800	1800	900	560	4500	2800	1800	1400	900
450	475	236	1180	750	236	375	1900	1180	600	3000	1900	950	600	4750	3000	1900	1500	950
355	530	265	1320	850	265	425	2120	1320	670	3350	2120	1060	670	5300	3350	2120	1700	1060
F_{r1max}	530	265	1320	850	265	425	2120	1320	670	3350	2120	1060	670	5300	3350	2120	1700	1060

n_1 min ⁻¹	160, 180				200, 225				250, 280			320 ... 360		
	I	2I CI	3I C2I	ICI	I	2I CI	3I C2I	ICI	I	2I CI	3I C2I	I	2I CI	3I C2I
1800	4750	3000	1900	1500	7500	4750	3000	2360	11800	7500	4750	19000	11800	7500
1400	5300	3350	2120	1700	8500	5300	3350	2650	13200	8500	5300	21200	13200	8500
1120	5600	3550	2240	1800	9000	5600	3550	2800	14000	9000	5600	22400	14000	9000
900	6000	3750	2360	1900	9500	6000	3750	3000	15000	9500	6000	23600	15000	9500
710	6700	4250	2650	2120	10600	6700	4250	3350	17000	10600	6700	26500	17000	10600
560	7100	4500	2800	2240	11200	7100	4500	3550	18000	11200	7100	28000	18000	11200
450	7500	4750	3000	2360	11800	7500	4750	3750	19000	11800	7500	30000	19000	11800
355	8500	5300	3350	2650	13200	8500	5300	4250	21200	13200	8500	33500	21200	13200
F_{r1max}	8500	5300	3350	2650	13200	8500	5300	4250	21200	13200	8500	33500	21200	13200

The radial load F_{r1} given by the following formula refers to most common:

$$F_{r1} = \frac{28650 \cdot P_1}{d \cdot n_1} \text{ [N] for timing belt drive}$$

$$F_{r1} = \frac{47750 \cdot P_1}{d \cdot n_1} \text{ [N] for V-belt drive}$$

where:

P_1 [kW] is the power required at the input side of gear reducer;

n_1 [min⁻¹] is the speed;

d [m] is the pitch diameter.

Radial loads given in the table are valid for overhung loads on centre line of high speed shaft end, i.e. operating at a distance of $0,5 \cdot e$ (e = shaft end length) from the shoulder. If radial loads are in a different position, i.e. at a distance differing from $0,5 \cdot e$ from shoulder, re-calculate the permissible value of radial load according to the following formula, trying not to exceed the maximum value F_{r1max}' stated in the table:

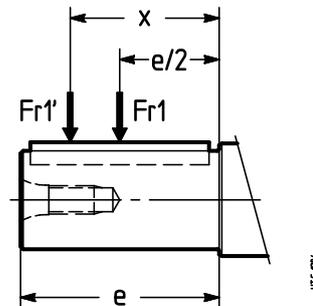
$$F_{r1}' = F_{r1} \cdot \frac{e/2 + y}{x + y} \text{ [N]}$$

where:

F_{r1}' [N] is the permissible radial load acting at the distance x from shaft shoulder;

F_{r1} [N] is the permissible radial load acting on centre line of high speed shaft end (see table above);

e [mm] is shaft end length (see ch. 8, 10);

y [mm] is given in the table;

x [mm] is the distance between the shaft shoulder and the load application point.

16.1 - Radial loads F_{r1} [N] on high speed shaft end

Size	y [mm]							
	R I	R 2I	R 3I	R CI	R ICI	R C2I		
40	-	-	-	-	-	-		
50	-	92	-	62 54	$i \leq 7,85$ $i \geq 10,3$	44		
63, 64	92	98	37,5	75 60	$i \leq 8$ $i \geq 10$	52,5		
80, 81	110	112	52,5	88 74	$i \leq 8,33$ $i \geq 10,4$	52,5		
100	142 136	$i \leq 3,27$ $i \geq 3,92$	137	63	99 87	$i \leq 7,85$ $i \geq 9,81$	63	
125	170 167	$i \leq 3,62$ $i \geq 4$	166	74	134 94	$i \leq 8$ $i \geq 10$	74	
140	166 173	$i \leq 4,08$ $i \geq 4,5$	166	98	134 94	$i \leq 9$ $i \geq 10,2$	74	
160	210	207	121	135 110	$i \leq 8,27$ $i \geq 9,04$	87	99 87	
180	214	207	121	135 110	$i \leq 9,33$ $i \geq 10,4$	87	134 94	
200	265	256	146	163 139	$i \leq 8,27$ $i \geq 8,93$	102	135 110	
225	265	256	146	163 139	$i \leq 9,33$ $i \geq 10,2$	-	135 110	
250	356 332	$i \leq 3,62$ $i \geq 4$	317	182	200 174	$i \leq 10$ $i \geq 11,4$	-	163 139
280	356 332	$i \leq 4,08$ $i \geq 4,5$	317	182	200 174	$i \leq 11,3$ $i \geq 12,9$	-	163 139
320, 321	417	390	222	256 250	$i \leq 6,27$ $i \geq 7,83$	-	204 174	
360	417	390	222	256 250	$i \leq 9,2$ $i \geq 10$	-	204 174	

It is always advisable **to mount the pulley against the shaft shoulder** and in any case to avoid that the pulley exceeds the shaft end.

An **axial load** of up to 0,2 times the value in the table is permissible, simultaneously with the radial load.

In absence of the radial load, an axial load may be acting on center line, not higher than 0,5 times the stated radial load.

IMPORTANT: tabulated values for radial load F_{r1} can increase considerably in certain instances (direction of rotation, angular position of load, etc.). If necessary and/or in presence of **misaligned** axial loads, consult us.

16.1 - Radial loads F_{r1} [N] on high speed shaft end

V-belt drives

In the table the motor pulleys are given for the several power and motor polarity, together with radial loads present on motor and gear reducer motor shaft.

The drives have been calculated with a service factor $\geq 1,4$; in order to increase the service factor with same d value and number of belts, replace section SPA with SPB, section SPB with SPC, section SPC with 8V.

The radial loads have been calculated according to the formula $\frac{47\,750 \cdot P_1}{d \cdot n_1}$.

Radial load F_{r1} , relevant to the motor pulley selected, must be less than or equal to the one permitted by gear reducer.

IMPORTANT: for the good drive running and in order not to overload the motor and gear reducer bearings, reduce the overhang to a minimum and do not stress the belts excessively. The pulleys with $d \geq 400$ must be dynamically balanced.

Motor		Motor pulley: belt number and section, pitch diameter d [mm], radial load F_{r1} [N]											
P_1 kW	Size. and pole n.	d	F_{r1} \approx	d	F_{r1} \approx	d	F_{r1} \approx	d	F_{r1} \approx	d	F_{r1} \approx	d	F_{r1} \approx
1,1	80B	2	2 Z 71	265	2 Z 80	236	2 Z 90	212	1 Z 100	190	1 Z 112	170	
	90S	4	2 A 90	425	2 A 100	375	2 A 112	335	1 A 125	300	1 A 140	265	
	90L	6	2 A 90	670	2 A 100	600	2 A 112	530	2 A 125	475	1 A 140	425	
1,5	90S	2	2 A 90	280	2 A 100	250	1 A 112	224	1 A 125	200	1 A 140	180	
	90L	4	2 A 90	560	2 A 100	500	2 A 112	450	2 A 125	400	1 A 140	355	
	100LA	6	3 A 90	900	3 A 100	800	2 A 112	710	2 A 125	630	2 A 140	560	
2,2	90LA	2	2 A 90	425	2 A 100	375	2 A 112	335	2 A 125	300	1 A 140	265	
	100LA	4	3 A 90	850	3 A 100	750	3 A 112	670	2 A 125	600	2 A 140	530	
	112M	6	3 A 112	1060	3 A 125	950	3 A 140	850	2 A 160	750	2 A 180	670	
3	100LA	2	3 A 90	560	3 A 100	500	2 A 112	450	2 A 125	400	2 A 140	355	
	100LB	4	3 A 112	900	3 A 125	800	2 A 140	710	2 A 160	630	2 A 180	560	
	132S	6	3 SPA 100	1600	3 SPA 112	1400	2 SPA 125	1250	2 SPA 140	1120	2 SPA 160	1000	
4	112M	2	3 A 100	670	3 A 112	600	2 A 125	530	2 A 140	475	2 A 160	425	
	112M	4	3 A 125	1060	3 A 140	950	3 A 160	850	2 A 180	750	2 A 200	670	
	132M	6	3 SPA 112	1900	3 SPA 125	1700	2 SPA 140	1500	2 SPA 160	1320	2 SPA 180	1180	
5,5	132S	2	3 SPA 100	950	3 SPA 112	850	2 SPA 125	750	2 SPA 140	670	2 SPA 160	600	
	132S	4	3 SPA 112	1700	3 SPA 125	1500	2 SPA 140	1320	2 SPA 160	1180	2 SPA 180	1060	
	132MB	6	3 SPA 140	2120	3 SPA 160	1900	2 SPA 180	1700	2 SPA 200	1500	2 SPA 224	1320	
7,5 (9,2)	132SB (SC)	2	3 SPA 112	1120	3 SPA 125	1000	2 SPA 140	900	2 SPA 160	800	2 SPA 180	710	
	132M (MB)	4	3 SPA 125¹⁾	2000	3 SPA 140	1800	2 SPA 160	1600	2 SPA 180	1400	2 SPA 200	1250	
	160M	6	3 SPA 160	2500	3 SPA 180	2240	3 SPA 200	2000	2 SPA 224	1800	2 SPA 250	1600	
11	160MR	2	3 SPA 125	1500	3 SPA 140	1320	2 SPA 160	1180	2 SPA 180	1060	2 SPA 200	950	
	160M	4	3 SPA 160	2360	3 SPA 180	2120	3 SPA 200	1900	2 SPA 224	1700	2 SPA 250	1500	
	160L	6	3 SPA 200	3000	3 SPA 224	2650	3 SPA 250	2360	2 SPA 280	2120	2 SPA 315	1900	
15	160M	2	3 SPA 140	1800	3 SPA 160	1600	3 SPA 180	1400	2 SPA 200	1250	2 SPA 224	1120	
	160L	4	3 SPA 180	2800	3 SPA 200	2500	3 SPA 224	2240	3 SPA 250	2000	2 SPA 280	1800	
	180L	6	4 SPA 200	4000	4 SPA 224	3550	4 SPA 250	3150	3 SPA 280	2800	3 SPA 315	2500	
18,5	160L	2	3 SPA 160	2000	3 SPA 180	1800	3 SPA 200	1600	3 SPA 224	1400	2 SPA 250	1250	
	180M	4	4 SPA 180	3550	4 SPA 200	3150	4 SPA 224	2800	3 SPA 250	2500	3 SPA 280	2240	
	200LR	6	4 SPB 200	5000	4 SPB 224	4500	3 SPB 250	4000	3 SPB 280	3550	3 SPB 315	3150	
22	180L	4	4 SPA 200	3750	4 SPA 224	3550	4 SPA 250	3000	3 SPA 280	2650	3 SPA 315	2360	
	200L	6	4 SPB 224	5300	4 SPB 250	4750	3 SPB 280	4250	3 SPB 315	3750	3 SPB 355	3550	
30	200L	4	4 SPB 224	4500	4 SPB 250	4000	3 SPB 280	3550	3 SPB 315	3150	3 SPB 355	2800	
	225M	6	5 SPB 250	6300	5 SPB 280	5600	4 SPB 315	5000	4 SPB 355	4500	4 SPB 400	4000	
37	225S	4	5 SPB 224	5600	5 SPB 250	5000	4 SPB 280	4500	4 SPB 315	4000	4 SPB 355	3550	
	250M	6	6 SPB 250	8000	6 SPB 280	7100	5 SPB 315	6300	5 SPB 355	5600	5 SPB 400	5000	
45	225M	4	5 SPB 250	6000	5 SPB 280	5300	4 SPB 315	4750	4 SPB 355	4250	4 SPB 400	3750	
55	250M	4	6 SPB 250	7500	6 SPB 280	6700	5 SPB 315	6000	5 SPB 355	5300	5 SPB 400	4750	
75	280S	4	6 SPB 280	9000	5 SPB 315	8000	5 SPB 355	7100	5 SPB 400	6400	-	-	-
90	280M	4	6 SPB 315	9000	5 SPC 315	9000	5 SPC 355	8000	4 SPC 400	7100	-	-	-
110	315S	4	6 SPC 315	11000	5 SPC 355	10000	4 SPC 400	8800	-	-	-	-	-
132	315M	4	6 SPC 355	12000	5 SPC 400	10600	4 SPC 450	10600	-	-	-	-	-
160	315MC	4	6 SPC 400	13000	6 SPC 450	11500	5 8V 450	11500	-	-	-	-	-

1) Not valid for power 9,2 kW: $d \geq 140$ mm.

Note: Pulley band width: **1 Z** 16, **2 Z** 28, **1A** 20, **2 A-2 SPA** 35, **3 A-3 SPA** 50, **4 SPA** 65, **3 SPB** 63, **4 SPB** 82, **5 SPB** 101, **6 SPB** 120, **4 SPC** 110, **5 SPC** 136, **6 SPC** 162, **5 8V** 152.

16.2 - Axial loads F_{a2} [N] or radial loads F_{r2} [N] on low speed shaft end

Axial loads F_{a2}

Permissible F_{a2} is shown in the column where direction of rotation of low speed shaft (black or white arrow) and direction of the axial force (solid or broken arrow) correspond to those of the gear reducer in question. Direction of rotation and direction of force may be established viewing the gear reducer from any point (from groove side or from opposite side to groove, indifferently), providing the same point is adopted for rotation and axial load (see fig. below).

Notes:

- White and black arrows of present chapter do not refer to the ones stating the correspondence of direction of rotation for the different designs (see ch. 8, 10, 12, 14);
- Wherever possible, choose the load conditions corresponding to the column with the highest admissible values.
- The values stated in the table are valid for the center line axial load; in the event of a misaligned axial load, consult us.

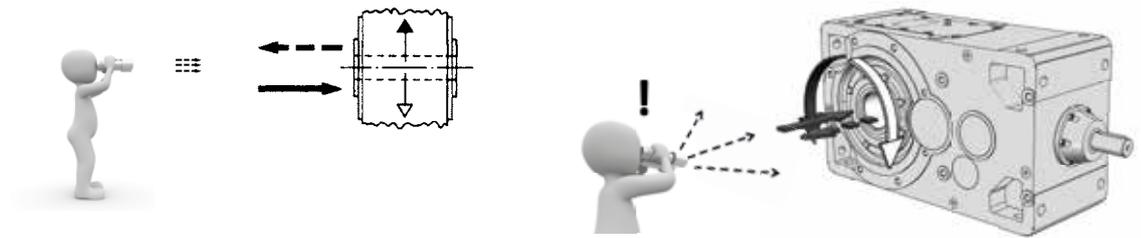

Radial loads F_{r2}

Radial loads generated on the shaft end by a drive connecting gear reducer and motor must be less than or equal to those given in the following pages.

Normally, radial loads on low speed shaft ends are considerable: in fact there is a tendency to connect the gear reducer to the machine by means of a transmission with high transmission ratio (economizing on the gear reducer) and with small diameters (economizing on the drive, and for requirements dictated by overall dimensions).

Bearing life and wear (which also affect gears unfavourably) and low speed shaft strength, clearly impose limits on permissible radial load.

The permissible radial loads stated in the tables are according to: low speed shaft end where the radial load is applied according to reference groove (see ch. 6) of the product of angular speed n_2 [min^{-1}] multiplied by the bearing life required L_h [h], of direction of rotation, of angular position φ [$^\circ$] of load and of torque required M_2 [N m].

The radial loads given in the tables are valid for loads on shaft center line of low speed shaft, i.e. at a distance from shoulder of $0,5 \cdot E$ (E = shaft end length); in the event of radial load acting in a different position (not center line), i.e. at a distance from shoulder different from $0,5 \cdot E$, re-calculate the permissible value of radial load according to the following formula, verifying simultaneously not to exceed the maximum value F_{r2max} given in the tables.

$$F_{r2}' = F_{r2} \cdot \frac{E/2 + y}{x + y} \quad [\text{N}]$$

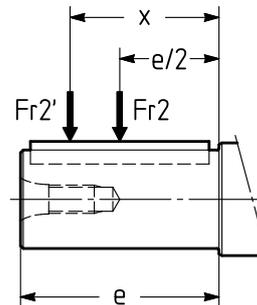

where:

F_{r2}' [N] is the permissible radial load acting at distance x from the shoulder;

F_{r2} [N] is the permissible radial load acting on center line of high speed shaft end (see table on following pages);

E [mm] is the shaft end length (see ch. 17);

y [mm] is given in the table;

x [mm] is the distance of load application starting from shaft shoulder.

	Size															
	40	50	63, 64	80	81	100	125	140	160	180	200	225 ¹⁾	250	280 ¹⁾	320, 321	360 ¹⁾
y	86	88	95	111	116	134	166	189	205	228	258	287 (279)	318	351 (344)	398	432 (424)

1) Values in brackets are valid for solid low speed shaft (see ch. 17(2)).

16.2 - Axial loads F_{a2} [N] or radial loads F_{r2} [N] on low speed shaft end

Chain drives

This drive is usually advised for low tip speeds ($v \leq 0,5$ m/s with periodical lubrication, $v \leq 1,5$ m/s with drop lubrication) and for this reason it is usually placed between gear reducer and machine. Compared with gear transmissions it offers the advantage of a high flexibility, allowing larger misalignments and higher distances among the shaft to be connected.

On the other hand, it is less suitable with alternate shock operations, in particular with high tip speed (shocks, noise, clearance worsening) and requires a specific maintenance as it is subjected to wear and periodic clearance taking up.

For the correct belt drive dimensioning refer to specific manufacturer's literature; as a rough guide, we can assume:

$$\rho \approx 0,5 \cdot D$$

$$d = \rho \cdot z / \pi$$

where:

ρ chain pitch

D diameter of gear reducer shaft end

d pinion pitch diameter

z pinion number of teeth

Keep in mind that the number of pinion teeth **z**, except some particular cases, should be at least **17** (the numbers of teeth classically adopted are: 17, 19, 21, 23) and that the smaller the pitch, the quieter the chain;

As a rough guide, for a rapid evaluation of the radial load generated on the low speed shaft end of gear reducer by a chain drive, see the table including:

- the **pitch diameter** values **d** of pinion and the **maximum transmissible power**, for two pinion speeds, according to pitch ρ and teeth number z
- the **maximum pinion width** b_{max} , the **mass** and the **maximum breaking load** R_R of chain, according to the pitch and to the chain (simple, double or triple).

No. teeth z	Pitch ρ																							
	1/2" (12,7)			5/8" (15,875)			3/4" (19,05)			1" (25,4)			1 1/4" (31,75)			1 1/2" (38,1)			1 3/4" (44,45)			2" (50,8)		
	d	P_{max} kW		d	P_{max} kW		d	P_{max} kW		d	P_{max} kW		d	P_{max} kW		d	P_{max} kW		d	P_{max} kW		d	P_{max} kW	
	mm	50 min ⁻¹	100 min ⁻¹	mm	50 min ⁻¹	100 min ⁻¹	mm	50 min ⁻¹	100 min ⁻¹	mm	50 min ⁻¹	100 min ⁻¹	mm	50 min ⁻¹	100 min ⁻¹	mm	50 min ⁻¹	100 min ⁻¹	mm	50 min ⁻¹	100 min ⁻¹	mm	50 min ⁻¹	100 min ⁻¹
15	60,7	0,27	0,91	75,8	0,4	0,7	91	0,6	1,2	121,3	1,8	3,4	151,7	3,2	6	182	5,1	9,5	212,3	8	15	242,7	12	21
16	64,7	0,29	1	80,9	0,4	0,8	97,1	0,7	1,4	129,4	1,9	3,5	161,8	3,4	6,3	194,1	5,5	10	226,5	8,5	16	258,9	12	23
17	68,8	0,32	1,05	85,9	0,5	0,8	103,1	0,8	1,5	137,5	2	3,7	171,9	3,6	6,8	206,3	5,8	11	240,7	9,1	17	275	13	24
18	72,8	0,34	1,12	91	0,5	0,9	109,2	0,8	1,5	145,6	2,2	4	182	3,8	7,2	218,4	6,2	12	254,8	9,6	18	291,2	14	26
19	76,8	0,36	1,18	96,1	0,5	0,9	115,3	0,9	1,6	153,7	2,3	4,2	192,1	4,1	7,6	230,5	6,6	12	269	10	19	307,4	15	28
20	80,9	0,37	1,26	101,1	0,6	0,9	121,3	0,9	1,7	161,8	2,4	4,4	202,2	4,3	8	242,7	6,9	13	283,1	11	20	323,6	16	29
21	84,9	0,38	1,33	106,2	0,6	1	127,4	1	1,8	169,9	2,5	4,7	212,3	4,6	8,5	254,8	7,3	14	297,3	11	21	339,7	17	36
22	89	0,4	1,41	111,2	0,6	1	133,5	1	1,9	178	2,7	4,9	222,5	4,8	8,9	266,9	7,7	14	311,4	12	22	355,9	17	32
23	93	0,41	1,5	116,3	0,6	1,1	139,5	1,1	2	186,1	2,8	5,2	232,6	5	9,3	279,1	8,1	15	325,6	13	24	372,1	18	34
24	97,1	0,43	1,58	121,3	0,6	1,1	145,6	1,1	2,1	194,1	2,9	5,4	242,7	5,3	9,8	291,2	8,5	16	339,7	13	25	388,3	19	35
25	101,1	0,45	1,65	126,4	0,7	1,1	151,7	1,2	2,2	202,2	3,1	5,7	252,8	5,5	10	303,3	8,8	17	353,9	14	26	404,5	20	37
26	105,2	0,47	1,71	131,4	0,73	1,14	157,7	1,25	2,29	210,3	3,18	5,8	262,9	5,65	10,3	315,5	9,1	17,8	368,1	14,5	27	420,6	20,6	38,5
27	109,2	0,49	1,78	136,5	0,76	1,19	163,8	1,30	2,38	218,4	3,25	5,9	273	5,75	10,6	327,6	9,6	18,5	382,2	15,5	28	436,8	21,2	39,2
28	113,2	0,51	1,9	141,6	0,8	1,3	169,9	1,4	2,6	226,5	3,3	6	283,1	5,9	11	339,7	10	19	396,4	16	29	453	22	42
29	117,3	0,53	1,97	146,6	0,83	1,35	175,9	1,45	2,7	234,6	3,4	6,21	293,2	6,1	11,6	351,9	10,6	19,6	410,5	16,6	29,6	469,2	23	43,5
30	121,3	0,55	2	151,7	0,9	1,4	182	1,5	2,8	242,7	3,5	6,5	303,3	6,3	12	364	11	20	424,7	17	31	485,4	24	45

Pitch ρ	Chain type									
	simple			double			triple			
inch	(mm)	b_{max} mm	mass kg/m	R_R N	b_{max} mm	mass kg/m	R_R N	b_{max} mm	mass kg/m	R_R N
1/2"	(12,7)	24	0,4	14 100	39	1,4	28 200	53	2	42 300
5/8"	(15,875)	27	0,9	22 200	44	1,7	44 400	61	2,5	66 600
3/4"	(19,05)	30	1,2	31 800	52	2,4	63 600	71	3,7	95 400
1"	(25,4)	46	2,7	56 700	79	5,2	113 400	111	8	170 100
1 1/4"	(31,75)	50	3,6	88 500	91	7,2	177 000	128	11	265 500
1 1/2"	(38,1)	65	6,7	127 000	115	13,5	254 000	164	21	381 000
1 3/4"	(44,45)	78	8,3	172 400	140	17	344 800	200	25	517 200
2"	(50,8)	78	10,5	226 800	141	21	453 600	200	32	680 400

16.2 - Axial loads F_{a2} [N] or radial loads F_{r2} [N] on low speed shaft end

Radial load F_{r2} for most common drives has the following value and angular position:

$$F_{r2} = \frac{19\,100 \cdot P_2}{d \cdot n_2} \text{ [N]}$$

for chain drive (lifting in general);
for timing belt drive replace 19100
with 28650

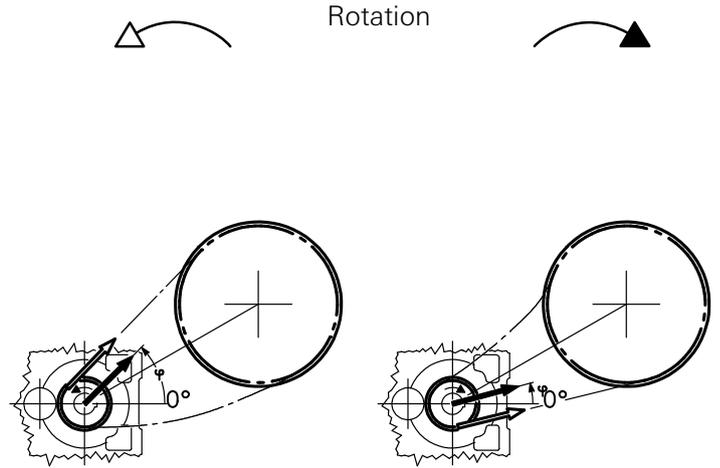

$$F_{r2} = \frac{47\,750 \cdot P_2}{d \cdot n_2} \text{ [N]}$$

for V-belt drive

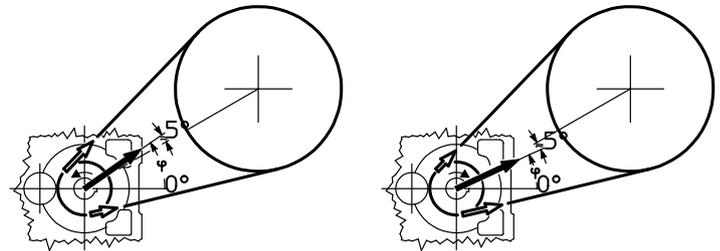

$$F_{r2} = \frac{20\,320 \cdot P_2}{d \cdot n_2} \text{ [N]}$$

for spur gear pair drive

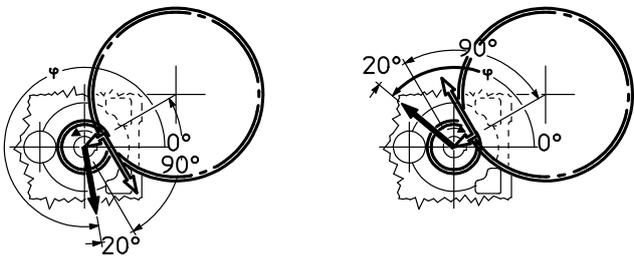

$$F_{r2} = \frac{67\,810 \cdot P_2}{d \cdot n_2} \text{ [N]}$$

for friction wheel drive (rubber-on-metal)

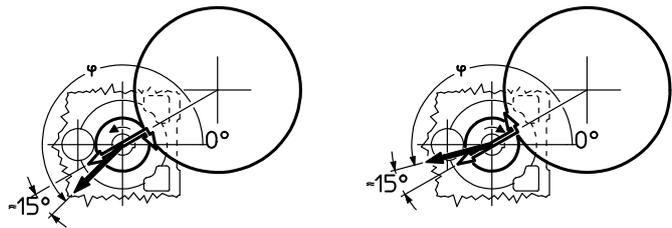

UTC 314

16

where: P_2 [kW] is power required at the output side of the gear reducer, n_2 [min^{-1}] is the speed, d [m] is the pitch diameter.

IMPORTANT: 0° coincides with a straight line concurrent with the axis of the last reduction and orientated as shown above, and therefore it follows the rotation of the housing, as shown below.

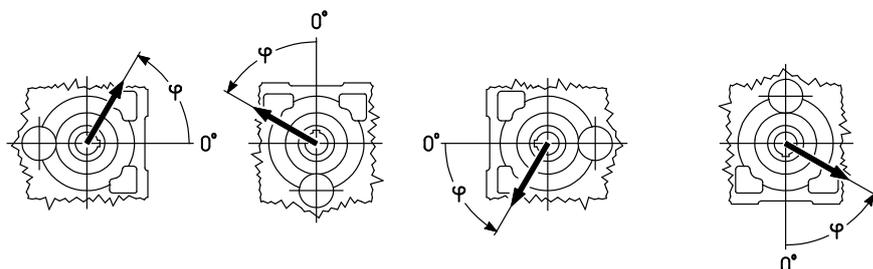

UTC 914

16.2 - Axial loads F_{a2} [N] or radial loads F_{r2} [N] on low speed shaft end

Radial load applied on **opposite side to groove**

Size **40**

$n_2 \cdot L_h$	N m	$F_{r2}^{1)2)}$														$F_{a2}^{1)}$				
		0	45	90	135	180	225	270	315	0	45	90	135	180	225	270	315			
355 000	80	2240	2240	2240	2240	2240	2240	2240	2240	2240	2240	2240	2240	2240	2240	2240	2240	2240	800	1600
	56	2240	2240	2240	2240	2240	2240	2240	2240	2240	2240	2240	2240	2240	2240	2240	2240	2240	800	1600
	40	2240	2240	2240	2240	2240	2240	2240	2240	2240	2240	2240	2240	2240	2240	2240	2240	2240	800	1600
450 000	80	2240	2240	2240	2240	2240	2240	2240	2240	2240	2240	2240	2240	2240	2240	2240	2240	2240	800	1600
	56	2240	2240	2240	2240	2240	2240	2240	2240	2240	2240	2240	2240	2240	2240	2240	2240	2240	800	1600
	40	2240	2240	2240	2240	2240	2240	2240	2240	2240	2240	2240	2240	2240	2240	2240	2240	2240	800	1600
560 000	80	2240	2240	2240	2240	2240	2120	2120	2240	2120	2000	2120	2240	2240	2240	2240	2240	2240	800	1600
	56	2240	2240	2240	2240	2240	2120	2120	2240	2120	2000	2120	2240	2240	2240	2240	2240	2240	800	1600
	40	2240	2240	2240	2240	2240	2120	2120	2240	2120	2000	2120	2240	2240	2240	2240	2240	2240	800	1600
710 000	80	2240	2240	2240	2240	2240	2000	1900	2000	1900	1800	1900	2240	2240	2240	2240	2240	2240	710	1500
	56	2240	2240	2240	2240	2240	2000	2000	2000	2000	2000	2000	2240	2240	2240	2240	2240	2240	800	1600
	40	2240	2240	2240	2240	2240	2120	2120	2240	2120	2000	2120	2240	2240	2240	2240	2240	2240	800	1600
900 000	80	2120	2240	2000	1900	2000	1800	1700	1900	1700	1600	1700	2000	2240	2240	2240	2120	530	1320	
	56	2120	2240	2240	2240	2000	1900	1900	2000	1900	1900	2000	2000	2240	2240	2240	2120	800	1400	
	40	2120	2240	2240	2240	2120	2000	1900	2000	1900	1900	2000	2120	2240	2240	2240	2120	800	1500	
1 120 000	80	2000	2240	1500	1400	1900	1600	1600	1700	1600	1400	1500	1900	2240	2000	1900	1900	400	1180	
	56	2000	2240	2240	2120	1900	1700	1700	1800	1700	1600	1700	1800	2240	2240	2240	2000	710	1250	
	40	2000	2120	2120	2120	1900	1800	1800	1900	1800	1800	1900	2000	2120	2240	2120	2000	800	1320	
1 400 000	56	1900	2120	2120	2000	1800	1600	1600	1700	1600	1500	1500	1800	2120	2240	2120	1800	560	1180	
	40	1900	2000	2000	1900	1800	1700	1600	1700	1600	1600	1600	1800	2000	2120	2000	1800	800	1180	
	28	1900	2000	2000	1900	1800	1700	1700	1800	1700	1600	1600	1800	2000	2000	2000	1800	800	1320	
1 800 000	56	1700	1900	2000	1800	1600	1400	1400	1500	1400	1320	1400	1600	1900	2120	1900	1700	480	1000	
	40	1700	1900	1900	1800	1600	1500	1500	1600	1500	1400	1500	1700	1900	2000	1900	1700	670	1120	
	28	1700	1800	1800	1800	1700	1600	1600	1600	1600	1500	1500	1700	1800	1900	1800	1700	800	1120	
2 240 000	56	1600	1800	1600	1500	1500	1320	1320	1400	1320	1180	1250	1500	1800	1900	1800	1500	360	900	
	40	1600	1700	1800	1700	1500	1400	1400	1500	1400	1320	1400	1500	1700	1800	1800	1600	560	950	
	28	1600	1700	1700	1600	1500	1500	1400	1500	1400	1400	1400	1600	1700	1800	1700	1600	710	1060	
2 800 000	40	1500	1600	1700	1600	1400	1320	1250	1320	1250	1180	1250	1400	1600	1700	1600	1400	500	850	
	28	1500	1600	1600	1500	1400	1320	1320	1400	1320	1250	1320	1400	1600	1700	1600	1500	630	900	
max 2 240																		max 80	max 160	

Size **50**

355 000	160	3000	3150	3150	3150	3150	3150	2800	2500	3150	3150	2800	3000	3150	3150	3150	3150	2240	1120
	112	3150	3150	3150	3150	3150	3150	3150	3000	3150	3150	3150	3150	3150	3150	3150	3150	2240	1120
	80	3150	3150	3150	3150	3150	3150	3150	3150	3150	3150	3150	3150	3150	3150	3150	3150	2240	1120
450 000	160	2650	3150	3150	3150	3150	3150	2500	2400	3150	2800	2500	2800	3150	3150	3150	3150	2240	900
	112	3000	3150	3150	3150	3150	3150	2800	2650	3150	3000	2800	3000	3150	3150	3150	3150	2240	1120
	80	3150	3150	3150	3150	3150	3150	3000	3000	3150	3150	3000	3150	3150	3150	3150	3150	2240	1120
560 000	160	2360	3150	3150	3150	3150	3000	2240	2000	3150	2500	2240	2500	3150	3150	3150	3150	2000	710
	112	2650	3150	3150	3150	3150	3150	2500	2360	3150	2800	2650	2800	3150	3150	3150	3150	2120	1120
	80	2800	3150	3150	3150	3150	3150	2800	2650	3150	3000	2800	3000	3150	3150	3150	3150	2240	1120
710 000	160	2000	3000	3150	3150	3150	2650	1900	1700	3000	2240	2000	2240	2800	2800	3000	3150	1800	500
	112	2360	3000	3150	3150	3150	2800	2240	2120	3000	2500	2360	2500	3000	3150	3150	3150	1900	1000
	80	2650	3000	3150	3150	3150	3000	2500	2360	3000	2650	2500	2650	3000	3150	3150	3150	2000	1120
900 000	160	1800	2650	3000	3150	3150	2360	1700	1500	2650	2000	1800	2000	2650	2000	2240	3150	1600	335
	112	2120	2800	3150	3150	3150	2650	2000	1900	2800	2360	2120	2240	2650	3150	3150	3150	1700	800
	80	2360	2800	3150	3150	3150	2650	2240	2240	2800	2500	2360	2500	2800	3150	3150	3150	1800	1120
1 120 000	160	1600	2360	2360	2650	3150	2120	1400	1250	2500	1800	1600	1800	2120	1320	1500	3150	1500	180
	112	1900	2500	3150	3150	3000	2360	1900	1800	2650	2120	1900	2120	2500	3150	3150	3150	1700	630
	80	2120	2650	3150	3150	3000	2500	2120	2000	2650	2240	2120	2240	2500	3000	3150	3000	1600	950
1 400 000	112	1800	2360	3150	3150	3000	2120	1700	1500	2360	1900	1700	1900	2360	2800	3000	3000	1400	500
	80	2000	2500	3000	3150	2800	2240	1900	1800	2360	2120	1900	2000	2360	2800	3000	2800	1500	800
	56	2120	2500	2800	3000	2650	2360	2120	2000	2500	2240	2120	2240	2360	2650	2800	2650	1500	1120
1 800 000	112	1600	2120	2800	3150	2800	1900	1500	1320	2120	1700	1500	1700	2120	2240	2500	2800	1250	355
	80	1800	2240	2800	3000	2650	2120	1700	1600	2240	1900	1700	1800	2120	2650	2800	2650	1320	670
	56	1900	2240	2650	2800	2500	2120	1900	1800	2240	2000	1900	2000	2240	2500	2650	2500	1320	900
2 240 000	112	1400	2000	2360	2650	2500	1800	1250	1180	2000	1500	1400	1500	1900	1800	1900	2650	1120	236
	80	1600	2120	2650	2800	2500	1900	1500	1400	2120	1700	1600	1700	2000	2360	2650	2500	1180	530
	56	1800	2120	2500	2500	2360	2000	1700	1600	2120	1800	1700	1800	2000	2360	2500	2360	1250	800
2 800 000	80	1500	2000	2500	2650	2360	1800	1400	1320	2000	1600	1500	1600	1900	2240	2500	2360	1060	450
	56	1700	2000	2360	2500	2240	1900	1600	1500	2000	1700	1600	1700	1900	2240	2360	2240	1120	710
max 3 150																		max 2 240	max 1 120

1) An axial load of up to 0,2 times the value in the table is permissible, simultaneously with the radial load. If exceeded consult us.

2) For radial loads acting simultaneously on both sides consult us.

16.2 - Axial loads F_{a2} [N] or radial loads F_{r2} [N] on low speed shaft end

Radial load applied on **groove side** ●

Size **40**

$n_2 \cdot L_h$		$F_{r2}^{1)2)}$												$F_{a2}^{1)}$					
min ⁻¹ ·h	N m	0	45	90	135	180	225	270	315	0	45	90	135	180	225	270	315		
355 000	80	1900	2240	2240	2240	2240	2120	1500	1400	2240	1700	1600	1900	2240	2240	2240	2240	800	1600
	56	2240	2240	2240	2240	2240	2240	1900	1900	2240	2120	2000	2240	2240	2240	2240	2240	800	1600
	40	2240	2240	2240	2240	2240	2240	2240	2240	2240	2240	2240	2240	2240	2240	2240	2240	800	1600
450 000	80	1600	2240	2240	2240	2240	1900	1320	1250	2120	1500	1400	1700	2240	2240	2240	2240	800	1600
	56	2000	2240	2240	2240	2240	2240	1700	1700	2240	1900	1800	2000	2240	2240	2240	2240	800	1600
	40	2240	2240	2240	2240	2240	2240	2000	2000	2240	2120	2000	2240	2240	2240	2240	2240	800	1600
560 000	80	1400	2240	2240	2240	2240	1600	1060	1060	1900	1250	1180	1500	2240	2240	2240	2240	800	1600
	56	1800	2240	2240	2240	2240	2000	1500	1500	2120	1700	1600	1900	2240	2240	2240	2240	800	1600
	40	2000	2240	2240	2240	2240	2240	1800	1800	2240	1900	1800	2120	2240	2240	2240	2240	800	1600
710 000	80	1180	2240	2240	2240	2240	1400	900	850	1600	1060	1000	1320	2120	2240	2240	2240	710	1500
	56	1600	2240	2240	2240	2240	1800	1320	1320	1900	1500	1400	1700	2240	2240	2240	2240	710	1600
	40	1900	2240	2240	2240	2240	2000	1600	1600	2120	1700	1700	1900	2240	2240	2240	2240	800	1600
900 000	80	950	2000	2240	2240	2240	1180	710	670	1400	900	800	1060	1900	2240	2240	2240	530	1320
	56	1400	2120	2240	2240	2240	1600	1180	1120	1700	1320	1180	1500	2120	2240	2240	2240	800	1400
	40	1700	2240	2240	2240	2240	1800	1400	1400	1900	1500	1500	1700	2120	2240	2240	2240	800	1500
1 120 000	80	750	1800	2240	2240	2240	950	530	500	1250	750	670	900	1800	2240	2240	2240	400	1180
	56	1250	2000	2240	2240	2240	1400	1000	950	1600	1120	1060	1320	1900	2240	2240	2240	710	1250
	40	1500	2000	2240	2240	2240	1600	1320	1250	1700	1400	1320	1500	2000	2240	2240	2240	800	1320
1 400 000	56	1120	1800	2240	2240	2120	1250	850	800	1400	1000	900	1180	1800	2240	2240	2240	560	1180
	40	1400	1900	2240	2240	2120	1500	1180	1120	1600	1250	1180	1400	1900	2240	2240	2120	800	1180
	28	1500	1900	2240	1320	2000	1600	1400	1320	1700	1400	1400	1500	1900	2240	2240	2000	800	1320
1 800 000	56	900	1700	2240	2240	1900	1060	710	670	1250	850	750	1000	1600	2240	2240	2000	480	1000
	40	1180	1700	2240	2240	1900	1320	1000	950	1400	1120	1060	1250	1700	2240	2240	2000	670	1120
	28	1400	1800	2120	2240	1900	1500	1180	1180	1500	1320	1250	1400	1700	2000	2120	1900	800	1120
2 240 000	56	750	1500	2240	2240	1800	900	560	530	1120	710	630	850	1500	2240	2240	1900	360	900
	40	1060	1600	2240	2240	1800	1180	850	850	1250	950	900	1120	1600	2120	2240	1800	560	950
	28	1250	1600	2000	2120	1800	1320	1120	1060	1400	1180	1120	1250	1600	1900	2000	1800	710	1060
2 800 000	40	950	1500	2120	2120	1700	1060	800	710	1180	850	800	1000	1400	2000	2120	1700	500	850
	28	1120	1500	1900	2000	1600	1250	1000	950	1320	1060	1000	1120	1500	1800	1900	1700	630	900
max 2 240																		max 800	max 1 600

Size **50**

355 000	160	2240	3150	3150	3150	3150	2800	1900	1700	3150	2240	2000	2500	3150	3150	3150	3150	2240	1120
	112	2800	3150	3150	3150	3150	3150	2500	2360	3150	2800	2650	3000	3150	3150	3150	3150	2240	1120
	80	3150	3150	3150	3150	3150	3150	3150	3000	2800	3150	3150	3000	3150	3150	3150	3150	2240	1120
450 000	160	1900	3150	3150	3150	3150	2360	1600	1500	2800	1900	1800	2120	3150	3150	3150	3150	2240	1060
	112	2500	3150	3150	3150	3150	3000	2240	2120	3150	2500	2360	2650	3150	3150	3150	3150	2240	1120
	80	3000	3150	3150	3150	3150	3150	2650	2500	3150	2800	2650	3000	3150	3150	3150	3150	2240	1120
560 000	160	1600	3000	3150	3150	3150	2120	1320	1180	2500	1700	1500	1900	3000	3150	3150	3150	2120	850
	112	2240	3150	3150	3150	3150	2650	2000	1800	3000	2240	2000	2360	3150	3150	3150	3150	2240	1120
	80	2650	3150	3150	3150	3150	3000	2360	2240	3000	2500	2360	2650	3150	3150	3150	3150	2240	1120
710 000	160	1320	2800	3150	3150	3150	1800	1000	950	2240	1400	1250	1600	2650	3150	3150	3150	1900	670
	112	2000	3000	3150	3150	3150	2360	1700	1600	2650	2000	1800	2120	3000	3150	3150	3150	2000	1120
	80	2360	3150	3150	3150	3150	2650	2120	2000	2800	2240	2120	2500	3000	3150	3150	3150	2000	1120
900 000	160	1060	2360	3150	3150	3150	1400	800	710	1900	1120	1000	1320	2360	3150	3150	3150	1700	450
	112	1700	2800	3150	3150	3150	2120	1500	1320	2360	1700	1600	1900	2650	3150	3150	3150	1800	900
	80	2120	3000	3150	3150	3150	2360	1900	1800	2650	2120	1900	2240	2800	3150	3150	3150	1800	1120
1 120 000	160	710	2000	3150	3150	3000	1060	500	450	1700	950	800	1060	2120	3150	3150	3150	1600	315
	112	1500	2500	3150	3150	3150	1900	1250	1180	2120	1500	1400	1700	2500	3150	3150	3150	1600	750
	80	1900	2650	3150	3150	3000	2240	1700	1600	2360	1900	1700	2000	2650	3150	3150	3150	1700	1060
1 400 000	112	1320	2240	3150	3150	3000	1600	1060	950	1900	1320	1180	1500	2240	3150	3150	3000	1500	600
	80	1700	2500	3150	3150	2800	2000	1500	1400	2120	1700	1500	1800	2360	3150	3150	3000	1500	900
	56	2000	2500	3000	3150	2800	2240	1800	1800	2240	2000	1900	2000	2500	3000	3000	2800	1600	1120
1 800 000	112	1060	2000	3150	3150	2650	1400	800	750	1700	1120	950	1250	2000	3150	3150	2800	1320	450
	80	1500	2240	3150	3150	2650	1800	1250	1180	1900	1500	1320	1600	2240	3000	3150	2650	1400	710
	56	1800	2360	2800	3000	2500	2000	1600	1500	2120	1700	1600	1800	2240	2800	3000	2650	1400	950
2 240 000	112	850	1800	3150	3150	2500	1120	670	600	1500	900	800	1060	1800	3000	3150	2650	1250	335
	80	1320	2120	3000	3150	2500	1600	1120	1060	1800	1320	1180	1400	2000	2800	3000	2500	1250	600
	56	1600	2120	2650	2800	2360	1800	1400	1400	1900	1600	1500	1700	2120	2650	2800	2500	1250	800
2 800 000	80	1180	2000	3000	3000	2360	1400	1000	85	1600	1120	1060	1250	1900	2650	2800	2500	1120	500
	56	1500	2000	2500	2650	2240	1700	1320	1250	1800	1500	1320	1500	2000	2500	2650	2360	1180	710
max 3 150																		max 2 240	max 1 120

1) An axial load of up to 0,2 times the value in the table is permissible, simultaneously with the radial load. If exceeded consult us.
2) For radial loads acting simultaneously on both sides consult us.

16.2 - Axial loads F_{a2} [N] or radial loads F_{r2} [N] on low speed shaft end

Radial load applied on **groove side** ●

Sizes **63, 64**

$n_2 \cdot L_h$	$F_{r2}^{1)2)}$	$F_{a2}^{1)}$																		
min ⁻¹ ·h	N m	0	45	90	135	180	225	270	315	0	45	90	135	180	225	270	315			
1 120 000	315	5000	5000	5000	5000	5000	5000	4750	5000	5000	4250	4500	5000	5000	5000	5000	5000	5000	1800	3550
	224	5000	5000	5000	5000	5000	5000	5000	5000	5000	5000	5000	5000	5000	5000	5000	5000	5000	1800	3550
	160	5000	5000	5000	5000	5000	5000	5000	5000	5000	5000	5000	5000	5000	5000	5000	5000	5000	1800	3550
	112	5000	5000	5000	5000	5000	5000	5000	5000	5000	5000	5000	5000	5000	5000	5000	5000	5000	1800	3550
1 400 000	224	5000	5000	5000	5000	5000	5000	5000	5000	5000	4500	4750	5000	5000	5000	5000	5000	5000	1800	3550
	160	5000	5000	5000	5000	5000	5000	5000	5000	5000	5000	5000	5000	5000	5000	5000	5000	5000	1800	3550
	112	5000	5000	5000	5000	5000	5000	5000	5000	5000	5000	5000	5000	5000	5000	5000	5000	5000	1800	3550
1 800 000	224	5000	5000	5000	5000	5000	5000	4750	4500	4750	4750	4000	4250	5000	5000	5000	5000	5000	1800	3550
	160	5000	5000	5000	5000	5000	5000	5000	5000	5000	4750	4750	5000	5000	5000	5000	5000	5000	1800	3550
	112	5000	5000	5000	5000	5000	5000	5000	5000	5000	5000	5000	5000	5000	5000	5000	5000	5000	1800	3550
2 240 000	224	5000	5000	5000	5000	5000	5000	4500	4000	4250	4250	3750	4000	5000	5000	5000	5000	5000	1800	3350
	160	5000	5000	5000	5000	5000	5000	4750	4500	4750	4750	4250	4500	5000	5000	5000	5000	5000	1800	3350
	112	5000	5000	5000	5000	5000	5000	5000	4750	5000	5000	4750	4750	5000	5000	5000	5000	5000	1800	3350
2 800 000	160	5000	5000	5000	5000	5000	5000	4500	4000	4250	4250	4000	4000	4750	5000	5000	5000	5000	1800	3150
	112	5000	5000	5000	5000	5000	5000	4750	4500	4750	4750	4250	4500	5000	5000	5000	5000	5000	1800	3150
3 550 000	160	4750	5000	5000	5000	5000	4750	4000	3750	4000	4000	3550	3750	4500	5000	5000	5000	5000	1800	3000
	112	4750	5000	5000	5000	5000	5000	4250	4000	4250	4250	4000	4000	4750	5000	5000	5000	5000	1800	3000
4 500 000	160	4250	5000	5000	5000	5000	4500	3750	3350	3750	3550	3150	3350	4000	5000	5000	5000	4500	1800	2800
	112	4500	5000	5000	5000	5000	4500	4000	3750	4000	4000	3550	3750	4250	5000	5000	5000	4750	1800	2800
5 600 000	160	4000	5000	5000	5000	5000	4250	3350	3150	3350	3350	2800	3000	3750	5000	5000	5000	4250	1600	2650
	112	4250	4750	5000	5000	4750	4250	3750	3550	3750	3750	3350	3350	4000	4750	5000	5000	4250	1800	2650
7 100 000	160	3750	4750	5000	4750	4000	3150	2800	3000	3000	2650	2800	3550	4750	5000	5000	4000	1400	2360	
	112	3750	4500	4750	4500	4000	3350	3150	3350	3350	3000	3150	3750	4500	5000	4750	4000	1800	2360	
max 5 000																		max 1 800	max 3 550	

Sizes **80, 81**

355 000	630	8000	8000	8000	8000	8000	8000	7500	7100	8000	8000	7500	8000	8000	8000	8000	8000	5600	2800		
	450	8000	8000	8000	8000	8000	8000	8000	8000	8000	8000	8000	8000	8000	8000	8000	8000	5600	2800		
	315	8000	8000	8000	8000	8000	8000	8000	8000	8000	8000	8000	8000	8000	8000	8000	8000	5600	2800		
450 000	630	7500	8000	8000	8000	8000	8000	8000	6700	6300	8000	7500	6700	8000	8000	8000	8000	8000	5600	2800	
	450	8000	8000	8000	8000	8000	8000	8000	7500	8000	8000	8000	8000	8000	8000	8000	8000	5600	2800		
	315	8000	8000	8000	8000	8000	8000	8000	8000	8000	8000	8000	8000	8000	8000	8000	8000	5600	2800		
560 000	630	6700	8000	8000	8000	8000	8000	8000	6000	5600	8000	6700	6300	7100	8000	8000	8000	8000	5600	2800	
	450	8000	8000	8000	8000	8000	8000	8000	7100	6700	8000	7500	7100	8000	8000	8000	8000	5600	2800		
	315	8000	8000	8000	8000	8000	8000	8000	8000	7500	8000	8000	8000	8000	8000	8000	8000	5600	2800		
710 000	630	6000	8000	8000	8000	8000	8000	7100	5300	4750	8000	6000	5600	6300	8000	8000	8000	8000	5600	2800	
	450	7100	8000	8000	8000	8000	8000	8000	6300	6000	8000	7100	6700	7500	8000	8000	8000	8000	5600	2800	
	315	8000	8000	8000	8000	8000	8000	8000	7500	7100	8000	7500	7500	8000	8000	8000	8000	5600	2800		
900 000	630	5300	8000	8000	8000	8000	8000	6700	4500	4250	7500	5300	5000	5600	8000	8000	8000	8000	5300	2650	
	450	6300	8000	8000	8000	8000	8000	7500	5600	5600	8000	6300	6000	6700	8000	8000	8000	8000	5600	2800	
	315	7100	8000	8000	8000	8000	8000	8000	6700	6300	8000	7100	6700	7500	8000	8000	8000	8000	5600	2800	
1 120 000	630	4750	7500	8000	8000	8000	8000	6000	4000	3550	6700	4750	4250	5000	7500	8000	8000	8000	5000	2360	
	450	6000	8000	8000	8000	8000	8000	6700	5300	5000	7500	6000	5300	6000	8000	8000	8000	8000	5000	2800	
	315	6700	8000	8000	8000	8000	8000	8000	7500	6000	6000	7500	6700	6300	6700	8000	8000	8000	8000	5300	2800
	224	7100	8000	8000	8000	8000	8000	7500	6700	6700	8000	7100	6700	7100	8000	8000	8000	8000	5300	2800	
1 400 000	450	5300	7500	8000	8000	8000	8000	6300	4750	4500	6700	5300	5000	5600	7500	8000	8000	8000	4750	2800	
	315	6000	7500	8000	8000	8000	8000	6700	5600	5300	7100	6000	5600	6300	7500	8000	8000	8000	5000	2800	
	224	6700	7500	8000	8000	8000	8000	7100	6300	6000	7500	6300	6300	6700	7500	8000	8000	8000	5000	2800	
1 800 000	450	4750	6700	8000	8000	8000	8000	5600	4000	3750	6300	4750	4250	5000	6700	8000	8000	8000	4250	2500	
	315	5600	7100	8000	8000	8000	8000	6300	5000	4750	6700	5600	5000	5600	7100	8000	8000	8000	4500	2800	
	224	6000	7100	8000	8000	8000	8000	6700	5600	5300	6700	6000	5600	6000	7100	8000	8000	8000	4500	2800	
2 240 000	450	4250	6300	8000	8000	8000	8000	5000	3750	3350	5600	4250	4000	4500	6300	8000	8000	8000	4000	2240	
	315	5000	6700	8000	8000	8000	8000	7500	5600	4500	4250	6300	5000	4750	5300	6300	8000	8000	7500	4250	2800
	224	5600	6700	8000	8000	8000	8000	7500	6000	5300	5000	6300	5600	5300	5600	6700	7500	8000	7500	4250	2800
2 800 000	315	4500	6300	8000	8000	8000	7100	5300	4250	4000	5600	4500	4250	4750	6000	7500	8000	7100	4000	2650	
	224	5000	6300	7500	7500	6700	5600	4750	4500	6000	5000	4750	5300	6000	7100	7500	7100	4000	2800		
3 550 000	315	4250	5600	7500	8000	8000	6700	4750	3750	3550	5300	4250	3750	4250	5600	7100	7500	6700	3550	2360	
	224	4750	5600	7100	7100	6300	5300	4250	4250	5600	4750	4500	4750	5600	6700	7100	6300	3750	2800		
4 500 000	315	3750	5300	7100	7500	6300	4500	3350	3150	4750	3750	3550	4000	5000	6700	7100	6300	3350	2000		
	224	4250	5300	6700	6700	6000	4750	4000	3750	5000	4250	4000	4250	5300	6300	6700	6000	3350	2500		
5 600 000	315	3350	5000	6700	7100	6000	4000	3000	2800	4500	3350	3150	3550	4750	6000	6700	6000	3150	1800		
	224	4000	5000	6300	6700	5600	4500	3550	3350	4750	4000	3750	4000	5000	6000	6300	5600	3150	2240		
7 100 000	315	3000	4500	6300	6700	5600	3750	2650	2360	4000	3000	2800	3150								

16.2 - Axial loads F_{a2} [N] or radial loads F_{r2} [N] on low speed shaft end

Radial load applied on **opposite side to groove**

Size **100**

$n_2 \cdot L_h$		$F_{r2}^{1)2)}$												$F_{a2}^{1)}$					
min ⁻¹ ·h	N m	0	45	90	135	180	225	270	315	0	45	90	135	180	225	270	315		
355 000	1 250	12500	12500	12500	12500	12500	12500	12500	12500	11800	11200	12500	12500	12500	12500	12500	12500	4500	9000
	900	12500	12500	12500	12500	12500	12500	12500	12500	12500	12500	12500	12500	12500	12500	12500	12500	4500	9000
	630	12500	12500	12500	12500	12500	12500	12500	12500	12500	12500	12500	12500	12500	12500	12500	12500	4500	9000
450 000	1 250	12500	12500	12500	11800	11800	11800	11800	12500	11200	10600	11200	12500	12500	12500	12500	12500	4500	9000
	900	12500	12500	12500	12500	12500	12500	12500	12500	11800	11200	12500	12500	12500	12500	12500	12500	4500	9000
	630	12500	12500	12500	12500	12500	12500	12500	12500	12500	12500	12500	12500	12500	12500	12500	12500	4500	9000
560 000	1 250	12500	12500	12500	10600	10000	10600	10600	11800	10000	9500	10600	12500	12500	12500	12500	11200	4500	9000
	900	12500	12500	12500	12500	12500	11200	11800	12500	11200	10600	11200	12500	12500	12500	12500	12500	4500	9000
	630	12500	12500	12500	12500	12500	11800	11800	12500	11800	11200	11800	12500	12500	12500	12500	12500	4500	9000
710 000	1 250	12500	12500	11200	9500	9000	9500	10000	11200	9000	8500	9500	11800	12500	12500	10600	10000	3750	8500
	900	12500	12500	12500	11800	11200	10600	10600	11800	10000	9500	10600	12500	12500	12500	11800	11800	4500	8500
	630	12500	12500	12500	12500	11800	11200	11200	11800	10600	10600	11200	12500	12500	12500	11800	11800	4500	9000
900 000	1 250	12500	11200	10000	8000	7500	8000	9000	10600	8500	7500	8500	11200	12500	11200	9500	8500	3150	7500
	900	11800	12500	11800	10600	10000	9500	10000	10600	9000	9000	9500	11200	12500	11800	10600	10600	4500	8000
	630	11800	12500	12500	11800	10600	10000	10000	11200	10000	9500	10000	11800	12500	12500	11200	11200	4500	8500
1 120 000	1 250	11200	10000	8000	7100	6300	6700	8500	9500	7500	7100	8000	10600	11200	10000	8500	7100	2500	7100
	900	11200	11800	10600	9500	9000	9000	9000	10000	8500	8000	9000	10600	12500	11800	10600	10000	4000	7500
	630	11200	11800	11800	11200	10000	9500	9500	10000	9000	9000	9500	10600	11800	12500	11800	10600	4500	7500
1 400 000	900	10600	11200	9500	8500	8000	8000	8500	9500	8000	7500	8000	10000	11800	11200	9500	9000	3550	7100
	630	10600	11200	11200	10600	9500	9000	9000	9500	8500	8000	8500	10000	11200	11800	11200	9500	4500	7100
	450	10600	11200	10600	10000	9500	9000	9000	9500	9000	8500	9000	10000	11200	11200	10600	10000	4500	7500
1 800 000	900	10000	10000	8500	7500	7100	7500	7500	8500	7100	6700	7500	9000	11200	10000	8500	7500	3000	6300
	630	10000	10600	10000	9500	8500	8000	8000	9000	7500	7500	8000	9500	10600	11200	10600	9000	4250	6700
	450	9500	10000	10000	9500	9000	8500	8500	9000	8000	8000	8500	9500	10000	10600	10000	9000	4500	6700
2 240 000	900	9500	9000	7500	6700	6000	6700	7100	8000	6300	6000	6700	8500	10000	9000	7500	6700	2500	6000
	630	9000	10000	9000	8500	8000	7500	7500	8000	7100	6700	7500	8500	10000	10600	9500	8500	3750	6300
	450	9000	9500	9500	9000	8000	8000	8000	8500	7500	7500	8000	9000	9500	10000	9500	8500	4500	6300
2 800 000	630	8500	9500	8500	7500	7500	6700	7100	7500	6700	6300	6700	8000	9500	9500	8500	7500	3350	5600
	450	8500	9000	9000	8500	7500	7100	7500	8000	7100	6700	7100	8000	9000	9500	9000	8000	4250	6000
	630	8000	8500	7500	6700	6300	6300	6300	7100	6000	5600	6300	7500	9000	8500	7500	7100	3000	5300
3 550 000	450	8000	8500	8500	8000	7100	6700	6700	7100	6300	6300	6700	7500	8500	9000	8500	7500	3750	5600
	630	7500	7500	6700	6000	5600	5600	6000	6700	5600	5300	5600	7100	8500	7500	6700	6300	2500	5000
	450	7500	8000	8000	7100	6700	6300	6300	6700	6000	5600	6300	7100	8000	8500	8000	6700	3350	5000
5 600 000	630	7100	7100	6300	5300	5000	5300	5300	6000	5000	4750	5300	6700	8000	7100	6300	5600	2240	4500
	450	7100	7500	7100	6700	6300	5600	5600	6300	5600	5300	5600	6700	7500	8000	7500	6300	3000	4750
	630	6700	6300	5600	4750	4250	4750	5000	5600	4500	4250	4750	6000	7100	6300	5300	5000	1900	4250
7 100 000	450	6300	7100	6300	6000	5600	5300	5300	5600	5000	4750	5300	6300	7100	7100	6700	6000	2650	4250
	630	6700	6300	5600	4750	4250	4750	5000	5600	4500	4250	4750	6000	7100	6300	5300	5000	1900	4250
	450	6300	7100	6300	6000	5600	5300	5300	5600	5000	4750	5300	6300	7100	7100	6700	6000	2650	4250
max 12 500																		max 4 500	max 9 000

1) An axial load of up to 0,2 times the value in the table is permissible, simultaneously with the radial load. If exceeded consult us.

2) For radial loads acting simultaneously on both sides consult us.

16.2 - Axial loads F_{a2} [N] or radial loads F_{r2} [N] on low speed shaft end

Radial load applied on **groove side** •

Size **100**

$n_2 \cdot L_h$		$F_{r2}^{1)2)}$														$F_{a2}^{1)}$			
min ⁻¹ ·h	N m	0	45	90	135	180	225	270	315	0	45	90	135	180	225	270	315		
355 000	1 250	12500	12500	12500	12500	12500	10600	9500	10600	10000	8000	9000	12500	12500	12500	12500	12500	4500	9000
	900	12500	12500	12500	12500	12500	11800	11200	11800	11800	10000	10600	12500	12500	12500	12500	12500	4500	9000
	630	12500	12500	12500	12500	12500	12500	12500	12500	12500	11800	11800	12500	12500	12500	12500	12500	4500	9000
450 000	1 250	12500	12500	12500	12500	12500	9500	8500	9500	8500	7100	7500	11200	12500	12500	12500	12500	4500	9000
	900	12500	12500	12500	12500	12500	11200	10000	10600	10600	9000	9500	12500	12500	12500	12500	12500	4500	9000
	630	12500	12500	12500	12500	12500	11800	11200	11800	11800	10600	11200	12500	12500	12500	12500	12500	4500	9000
560 000	1 250	11800	12500	12500	12500	11800	8500	7500	8500	7500	6000	6700	10000	12500	12500	12500	12500	4500	9000
	900	12500	12500	12500	12500	12500	10000	9000	10000	9500	8000	8500	11200	12500	12500	12500	12500	4500	9000
	630	12500	12500	12500	12500	12500	11200	10000	11200	10600	9500	10000	11800	12500	12500	12500	12500	4500	9000
710 000	1 250	10600	12500	12500	12500	10600	7500	6700	7500	6700	5300	5600	9000	12500	12500	12500	11200	3750	8500
	900	11200	12500	12500	12500	11800	9000	8000	9000	8500	7100	7500	10600	12500	12500	12500	11800	4500	8500
	630	11800	12500	12500	12500	11800	10000	9500	10000	10000	8500	9000	11200	12500	12500	12500	12500	4500	9000
900 000	1 250	10000	12500	12500	12500	9000	6700	5600	6700	5600	4250	5000	8000	12500	12500	12500	10000	3150	7500
	900	10600	12500	12500	12500	10600	8000	7500	8000	7500	6300	6700	9500	12500	12500	12500	11200	4500	8000
	630	11200	12500	12500	12500	11200	9500	8500	9000	9000	8000	8500	10600	12500	12500	12500	11200	4500	8500
1 120 000	1 250	9000	12500	12500	11200	8000	6000	5000	5600	4750	3550	4000	7100	12500	12500	12500	9000	2500	7100
	900	10000	12500	12500	12500	10000	7500	6700	7500	6700	5600	6300	8500	12500	12500	12500	10000	4000	7500
	630	10000	12500	12500	12500	10600	8500	8000	8500	8000	7100	7500	9500	12500	12500	12500	10600	4500	7500
1 400 000	450	10600	11800	12500	11800	10600	9000	8500	9000	9000	8000	8500	10000	11800	12500	12500	10600	4500	8000
	900	9000	12500	12500	11200	9500	6700	6000	6700	6000	5000	5300	8000	11800	12500	12500	9500	3550	7100
	630	9500	11800	12500	11800	9500	8000	7100	7500	7500	6300	6700	9000	11800	12500	12500	10000	4500	7100
1 800 000	450	10000	11200	11800	11200	10000	8500	8000	8500	8500	7500	8000	9500	11200	12500	11800	10000	4500	7500
	900	8000	11800	11800	10600	8000	6000	5000	5600	5300	4250	4750	7100	11200	12500	11800	8500	3000	6300
	630	8500	11200	12500	11200	9000	7100	6300	7100	6700	5600	6300	8000	11200	12500	11800	9000	4250	6700
2 240 000	450	9000	10600	11200	10600	9000	7500	7100	7500	7500	6700	7100	8500	10600	11800	11200	9500	4500	6700
	900	7500	10600	11200	9500	7100	5300	4500	5300	4750	3550	4000	6300	10600	12500	10600	8000	2500	6000
	630	8000	10600	11800	10600	8500	6300	5600	6300	6000	5000	5600	7500	10600	12500	11200	8500	3750	6300
2 800 000	450	8500	10000	10600	10000	8500	7100	6700	7100	7100	6300	6300	8000	10000	11200	10600	8500	4500	6300
	900	7500	10000	10600	9500	7500	6000	5300	5600	5600	4500	5000	6700	9500	11800	10600	8000	3350	5600
	630	8000	9500	10000	9500	8000	6700	6000	6300	6300	5600	6000	7500	9500	10600	10000	8000	4250	6000
3 550 000	450	7100	9500	10000	9000	7100	5300	4750	5300	5000	4000	4500	6300	9000	11200	10000	7100	3000	5300
	900	630	7100	9000	9500	9000	7500	6000	6000	5600	5000	5300	6700	9000	10000	9500	7500	3750	5600
	630	6300	8500	9000	8000	6700	4750	4250	4750	4250	3550	3750	5600	8500	10000	9000	6700	2500	5000
4 500 000	450	6700	8500	9000	8500	6700	5600	5000	5300	5300	4500	4750	6300	8000	9500	9000	7100	3350	5000
	900	6000	8000	8500	7500	6000	4250	3750	4250	3750	3000	3350	5000	8000	9500	8500	6300	2240	4500
	630	6300	8000	8500	8000	6300	5000	4500	5000	4750	4000	4250	5600	8000	9000	8500	6300	3000	4750
5 600 000	450	5300	7500	8000	6700	5000	3750	3150	3750	3350	2500	2800	4500	7500	9000	7500	5600	1900	4250
	900	5600	7500	8000	7500	6000	4500	4000	4500	4250	3550	4000	5300	7500	8500	8000	6000	2650	4250
	630	5600	7500	8000	7500	6000	4500	4000	4500	4250	3550	4000	5300	7500	8500	8000	6000	2650	4250
max 12 500																		max 4 500	max 9 000

- 1) An axial load of up to 0,2 times the value in the table is permissible, simultaneously with the radial load. If exceeded consult us.
 2) For radial loads acting simultaneously on both sides consult us.

16.2 - Axial loads F_{a2} [N] or radial loads F_{r2} [N] on low speed shaft end

Radial load applied on **opposite side to groove**

Size **125**

$n_2 \cdot L_h$	min ¹ ·h	N m	$F_{r2}^{1) 2) 3)}$														$F_{a2}^{1)}$			
			0	45	90	135	180	225	270	315	0	45	90	135	180	225	270	315		
355 000	2 500		20000	20000	20000	20000	20000	20000	20000	20000	20000	20000	20000	20000	20000	20000	20000	20000	14000	7100
	1 800		20000	20000	20000	20000	20000	20000	20000	20000	20000	20000	20000	20000	20000	20000	20000	20000	14000	7100
450 000	2 500		19000	20000	20000	20000	20000	20000	20000	19000	18000	20000	20000	20000	20000	20000	20000	14000	7100	
	1 800		20000	20000	20000	20000	20000	20000	20000	20000	19000	20000	20000	20000	20000	20000	20000	14000	7100	
560 000	2 500		17000	19000	20000	20000	20000	20000	20000	18000	16000	20000	20000	20000	20000	20000	20000	14000	6700	
	1 800		19000	20000	20000	20000	20000	20000	20000	19000	18000	20000	20000	20000	20000	20000	20000	14000	7100	
710 000	2 500		15000	16000	18000	20000	20000	20000	20000	16000	14000	20000	20000	20000	20000	20000	20000	13200	5600	
	1 800		17000	20000	20000	20000	20000	20000	20000	18000	16000	20000	20000	20000	20000	20000	20000	13200	7100	
900 000	2 500		14000	14000	16000	19000	20000	19000	15000	13200	15000	13200	15000	14000	16000	16000	19000	11800	4750	
	1 800		16000	18000	20000	20000	20000	19000	16000	15000	20000	18000	16000	17000	18000	20000	20000	12500	7100	
	1 250		17000	19000	20000	20000	20000	19000	17000	16000	20000	18000	17000	18000	20000	20000	20000	12500	7100	
1 120 000	2 500		12500	11800	14000	17000	19000	18000	13200	11800	19000	16000	14000	11800	10600	11800	15000	11200	3750	
	1 800		14000	17000	18000	20000	20000	18000	15000	13200	20000	17000	15000	15000	16000	18000	20000	11800	6300	
	1 250		15000	17000	20000	20000	20000	18000	16000	15000	20000	17000	16000	17000	19000	20000	20000	11800	7100	
1 400 000	1 800		13200	15000	16000	18000	20000	17000	14000	12500	20000	18000	14000	14000	16000	18000	18000	10600	5300	
	1 250		14000	16000	19000	20000	19000	17000	15000	14000	20000	18000	15000	16000	17000	19000	19000	11200	7100	
1 800 000	1 800		11800	13200	14000	16000	18000	15000	12500	11200	20000	17000	12500	11800	12500	14000	16000	10000	4500	
	1 250		13200	15000	17000	19000	18000	16000	13200	12500	20000	18000	13200	14000	16000	17000	18000	10000	6300	
2 240 000	1 800		11200	11800	12500	15000	17000	14000	11200	10000	20000	16000	11200	10000	11200	13200	15000	9500	4000	
	1 250		11800	14000	16000	17000	17000	14000	12500	11800	20000	17000	12500	12500	13200	14000	15000	9500	5600	
2 800 000	1 250		11200	13200	14000	16000	16000	13200	11800	10600	20000	16000	14000	12500	13200	14000	16000	9000	5000	
	900		11800	13200	15000	16000	15000	14000	11800	11200	20000	17000	12500	12500	13200	14000	15000	9000	6300	
3 550 000	1 250		10000	11800	13200	14000	15000	12500	10600	9500	20000	16000	11200	11800	12500	14000	14000	8000	4500	
	900		11200	12500	14000	15000	14000	12500	11200	10600	20000	17000	12500	11800	13200	14000	14000	8500	5600	
4 500 000	1 250		9500	10600	11800	13200	14000	11800	9500	9000	20000	16000	10000	10000	10000	11800	13200	7500	4000	
	900		10000	11200	13200	14000	13200	11800	10600	9500	20000	17000	10600	11200	12500	13200	13200	7500	5000	
5 600 000	1 250		8500	9500	10600	11800	13200	11200	9000	8000	20000	16000	8500	9000	10600	11800	11800	7100	3350	
	900		9500	10600	12500	13200	12500	11200	9500	9000	20000	17000	9500	10600	11200	11800	12500	7100	4500	
7 100 000	1 250		8000	8500	9000	10600	11800	10000	8000	7500	20000	16000	8000	8000	9500	10600	10600	6700	2800	
	900		8500	10000	11200	12500	11800	10000	9000	8000	20000	17000	8500	9000	10000	11200	11800	6700	4000	
max 20 000																	max 14 000	max 7 100		

Size **140**

280 000	3 750	28000	28000	28000	28000	28000	28000	28000	28000	28000	28000	28000	28000	28000	28000	28000	28000	18000	9000
	2 650	28000	28000	28000	28000	28000	28000	28000	28000	28000	28000	28000	28000	28000	28000	28000	28000	18000	9000
355 000	3 750	25000	28000	28000	28000	28000	28000	28000	26500	23600	28000	28000	28000	28000	28000	28000	28000	18000	9000
	2 650	28000	28000	28000	28000	28000	28000	28000	26500	23600	28000	28000	28000	28000	28000	28000	28000	18000	9000
450 000	3 750	23600	28000	28000	28000	28000	28000	28000	23600	21200	28000	28000	28000	28000	28000	28000	28000	18000	9000
	2 650	25000	28000	28000	28000	28000	28000	28000	26500	23600	28000	28000	28000	28000	28000	28000	28000	18000	9000
560 000	3 750	21200	23600	26500	28000	28000	28000	22400	20000	20000	28000	28000	28000	28000	28000	28000	28000	17000	7500
	2 650	23600	26500	28000	28000	28000	28000	23600	22400	20000	28000	28000	28000	28000	28000	28000	28000	18000	9000
710 000	3 750	19000	21200	23600	28000	28000	25000	20000	18000	18000	28000	28000	28000	28000	28000	28000	28000	16000	6300
	2 650	21200	25000	28000	28000	28000	26500	22400	20000	20000	28000	28000	28000	28000	28000	28000	28000	16000	9000
	1 900	22400	25000	28000	28000	28000	26500	23600	22400	20000	28000	28000	28000	28000	28000	28000	28000	17000	9000
900 000	3 750	18000	18000	21200	25000	26500	23600	18000	16000	16000	28000	28000	28000	28000	28000	28000	28000	15000	5000
	2 650	20000	23600	26500	28000	28000	28000	23600	20000	19000	28000	28000	28000	28000	28000	28000	28000	15000	8500
	1 900	21200	23600	26500	28000	28000	25000	21200	20000	20000	28000	28000	28000	28000	28000	28000	28000	15000	9000
1 120 000	2 650	18000	22400	23600	26500	26500	22400	19000	17000	17000	28000	28000	28000	28000	28000	28000	28000	14000	7500
	1 900	20000	22400	25000	26500	26500	22400	20000	19000	19000	28000	28000	28000	28000	28000	28000	28000	14000	9000
1 400 000	2 650	16000	19000	21200	23600	25000	21200	17000	15000	15000	28000	28000	28000	28000	28000	28000	28000	13200	6300
	1 900	18000	21200	23600	25000	23600	21200	18000	17000	17000	28000	28000	28000	28000	28000	28000	28000	13200	8500
1 800 000	2 650	15000	17000	19000	21200	23600	19000	15000	14000	14000	28000	28000	28000	28000	28000	28000	28000	11800	5300
	1 900	16000	19000	22400	23600	22400	20000	17000	16000	16000	28000	28000	28000	28000	28000	28000	28000	12500	7500
2 240 000	1 900	15000	18000	20000	22400	21200	18000	15000	14000	14000	28000	28000	28000	28000	28000	28000	28000	11800	6700
	1 320	16000	18000	20000	21200	21200	19000	16000	16000	16000	28000	28000	28000	28000	28000	28000	28000	11800	8500
2 800 000	1 900	14000	17000	19000	20000	20000	17000	14000	13200	13200	28000	28000	28000	28000	28000	28000	28000	10600	6000
	1 320	15000	17000	19000	20000	19000	17000	15000	14000	14000	28000	28000	28000	28000	28000	28000	28000	11200	7500
3 550 000	1 900	12500	15000	17000	19000	19000	16000	13200	11800	11800	28000	28000	28000	28000	28000	28000	28000	10000	5000
	1 320	14000	16000	18000	19000	18000	16000	14000	13200	13200	28000	28000	28000	28000	28000	28000	28000	10000	6700
4 500 000	1 900	11800	14000	15000	17000	18000	15000	11800	10600	10600	28000	28000	28000	28000	28000	28000	28000	9000	4500
	1 320	12500	15000																

16.2 - Axial loads F_{a2} [N] or radial loads F_{r2} [N] on low speed shaft end

Radial load applied on **groove side** •

Size **125**

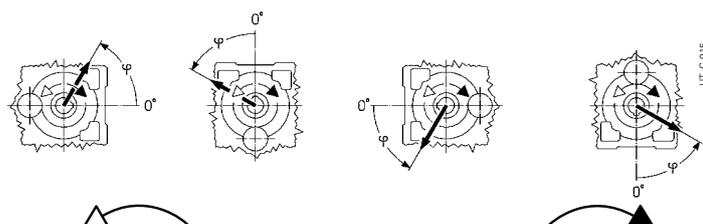
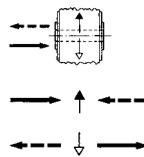
$n_2 \cdot L_h$		$F_{r2}^{1)2)3)}$														$F_{a2}^{1)}$			
																			
min ⁻¹ ·h	N m	0	45	90	135	180	225	270	315	0	45	90	135	180	225	270	315		
355 000	2 500	17000	20000	20000	20000	20000	20000	15000	14000	20000	18000	16000	18000	20000	20000	20000	20000	14000	7100
	1 800	20000	20000	20000	20000	20000	20000	20000	18000	17000	20000	20000	19000	20000	20000	20000	20000	14000	7100
450 000	2 500	15000	20000	20000	20000	20000	19000	13200	12500	20000	16000	14000	16000	20000	20000	20000	14000	7100	
	1 800	18000	20000	20000	20000	20000	20000	16000	15000	20000	18000	17000	19000	20000	20000	20000	14000	7100	
560 000	2 500	13200	20000	20000	20000	20000	17000	11800	10600	20000	14000	13200	15000	20000	20000	20000	14000	6700	
	1 800	16000	20000	20000	20000	20000	19000	15000	14000	20000	17000	15000	17000	20000	20000	20000	14000	7100	
710 000	2 500	11800	19000	20000	20000	20000	15000	10000	9000	18000	13200	11200	13200	17000	20000	20000	13200	5600	
	1 800	15000	20000	20000	20000	20000	18000	13200	12500	19000	15000	14000	15000	20000	20000	20000	13200	7100	
900 000	2 500	10000	17000	20000	20000	20000	14000	8500	8000	16000	11200	10000	11800	15000	20000	20000	11800	4750	
	1 800	13200	19000	20000	20000	20000	16000	11800	11200	18000	14000	12500	14000	18000	20000	20000	12500	7100	
1 120 000	2 500	8500	15000	20000	20000	20000	12500	7500	6700	15000	10000	8500	10600	13200	18000	20000	11200	3750	
	1 800	11800	17000	20000	20000	20000	15000	10600	10000	16000	12500	11200	12500	17000	20000	20000	11800	6300	
1 400 000	2 500	10600	16000	20000	20000	20000	13200	9500	8500	15000	11200	10000	11800	16000	19000	20000	10600	5300	
	1 800	12500	17000	20000	20000	20000	15000	11800	11200	16000	13200	12500	13200	16000	20000	20000	11200	7100	
1 800 000	1 800	9000	14000	20000	20000	19000	11800	8000	7500	14000	10000	9000	10000	14000	17000	19000	10000	4500	
	1 250	11800	15000	20000	20000	18000	14000	10600	10000	15000	11800	11200	11800	15000	19000	18000	10000	6300	
2 240 000	1 800	8000	13200	18000	20000	18000	10600	7100	6300	12500	9000	8000	9000	11800	16000	18000	9500	4000	
	1 250	10600	14000	19000	20000	17000	12500	9500	9000	14000	10600	10000	11200	14000	19000	17000	9500	5600	
2 800 000	1 250	9500	13200	18000	19000	16000	11800	8500	8000	12500	10000	9000	10000	13200	16000	16000	9000	5000	
	900	10600	14000	17000	18000	16000	12500	10000	9500	13200	11200	10600	11200	13200	16000	17000	9000	6300	
3 550 000	1 250	8500	12500	17000	18000	15000	10600	7500	7100	11800	9000	8000	9000	11800	15000	15000	8000	4500	
	900	10000	12500	16000	17000	15000	11200	9000	8500	11800	10000	9500	10000	12500	15000	15000	8500	5600	
4 500 000	1 250	7500	11200	15000	17000	14000	9500	6700	6300	10600	8000	7100	8000	11200	13200	14000	7500	4000	
	900	9000	11800	15000	16000	14000	10600	8000	7500	11200	9000	8500	9500	11200	14000	14000	7500	5000	
5 600 000	1 250	6700	10600	14000	16000	13200	8500	6000	5300	10000	7100	6300	7500	10000	12500	14000	7100	3350	
	900	8000	11200	14000	15000	13200	9500	7500	7100	10600	8500	7500	8500	10600	13200	14000	7100	4500	
7 100 000	1 250	6000	9500	12500	14000	12500	7500	5000	4750	9000	6300	5600	6700	8500	11200	13200	6700	2800	
	900	7500	10000	13200	14000	12500	9000	6700	6300	9500	7500	7100	7500	10000	12500	12500	6700	4000	
max 20 000																		max 14 000	max 7 100

Size **140**

280 000	3 750	23600	28000	28000	28000	28000	28000	22400	20000	28000	25000	22400	25000	28000	28000	28000	28000	18000	9000
	2 650	28000	28000	28000	28000	28000	28000	28000	25000	25000	28000	28000	26500	28000	28000	28000	28000	18000	9000
355 000	3 750	21200	28000	28000	28000	28000	26500	19000	18000	28000	22400	20000	23600	28000	28000	28000	18000	9000	
	2 650	25000	28000	28000	28000	28000	28000	23600	22400	28000	26500	23600	26500	28000	28000	28000	18000	9000	
450 000	3 750	19000	28000	28000	28000	28000	25000	17000	16000	28000	21200	19000	21200	28000	28000	28000	18000	9000	
	2 650	23600	28000	28000	28000	28000	26500	21200	20000	28000	23600	22400	23600	28000	28000	28000	18000	9000	
560 000	3 750	17000	26500	28000	28000	28000	22400	15000	14000	25000	19000	16000	19000	25000	28000	28000	17000	7500	
	2 650	21200	28000	28000	28000	28000	25000	19000	18000	26500	20000	20000	21200	26500	28000	28000	18000	9000	
710 000	3 750	15000	23600	28000	28000	28000	20000	13200	11800	23600	16000	14000	17000	21200	28000	28000	16000	6300	
	2 650	19000	25000	28000	28000	28000	22400	17000	16000	25000	20000	18000	20000	25000	28000	28000	16000	9000	
900 000	1 900	21200	26500	28000	28000	28000	23600	20000	19000	25000	21200	20000	21200	25000	28000	28000	17000	9000	
	3 750	13200	21200	28000	28000	28000	18000	11200	10000	21200	15000	13200	15000	19000	25000	28000	15000	5000	
1 120 000	2 650	17000	23600	28000	28000	28000	21200	15000	14000	22400	18000	16000	18000	23600	28000	28000	15000	8500	
	1 900	19000	25000	28000	28000	28000	22400	18000	17000	23600	20000	19000	20000	23600	28000	28000	15000	9000	
1 400 000	2 650	15000	22400	28000	28000	28000	19000	14000	12500	21200	16000	15000	16000	21200	26500	28000	14000	7500	
	1 900	18000	22400	28000	28000	26500	21200	17000	16000	22400	18000	17000	18000	22400	26500	26500	14000	9000	
1 800 000	2 650	13200	20000	26500	28000	25000	17000	12500	11200	19000	14000	13200	15000	20000	23600	26500	13200	6300	
	1 900	16000	21200	26500	28000	25000	19000	15000	14000	20000	17000	15000	17000	20000	25000	25000	13200	8500	
2 240 000	2 650	11800	19000	25000	28000	23600	16000	10600	10000	18000	13200	11800	13200	17000	21200	25000	11800	5300	
	1 900	15000	20000	25000	26500	23600	17000	13200	12500	19000	15000	14000	15000	19000	23600	23600	12500	7500	
2 800 000	1 900	13200	18000	23600	26500	22400	16000	12500	11200	18000	14000	12500	14000	18000	22400	22400	11800	6700	
	1 320	15000	19000	22400	23600	21200	17000	14000	13200	18000	15000	14000	15000	18000	21200	21200	11800	8500	
3 550 000	1 900	11800	17000	22400	25000	21200	15000	10600	10000	16000	12500	11200	13000	16000	20000	22400	10600	6000	
	1 320	14000	17000	21200	22400	20000	16000	13200	12500	17000	14000	13200	14000	17000	20000	21200	11200	7500	
4 500 000	1 900	10600	15000	21200	23600	19000	13200	9500	9000	15000	11200	10000	11800	15000	18000	20000	10000	5000	
	1 320	12500	16000	20000	21200	19000	14000	11800	11200	15000	13200	11800	13200	15000	19000	19000	10000	6700	
5 600 000	1 900	9500	14000	19000	21200	18000	12500	8500	8000	14000	10000	9000	10600	14000	17000	19000	9000	4500	
	1 320	11800	15000	19000	20000	18000	13200	10600	10000	14000	11800	11200	11800	15000	18000	18000	9500	6300	
7 100 000	1 900	8500	13200	17000	20000	17000	11200	7500	6700	12500	9000	8000	9500	12500	15000	17000	8500	3750	
	1 320	10000	14000	18000	19000	16000	12500	9500	9000	13200	10600	10000	11200	13200	17000	17000	9000	5300	
max 28 000 (16 000 for «short side»)																		max 18 000</	

16.2 - Axial loads F_{a2} [N] or radial loads F_{r2} [N] on low speed shaft end

Radial load applied on **opposite side to groove**

Size **160**

$n_2 \cdot L_h$	min ¹ ·h	N m	$F_{r2}^{1) 2) 3)}$														$F_{a2}^{1)}$			
			0	45	90	135	180	225	270	315	0	45	90	135	180	225	270	315		
280 000	5 600	35500	35500	35500	33500	33500	31500	31500	33500	30000	28000	30000	35500	35500	35500	35500	35500	35500	11200	22400
	4 000	35500	35500	35500	35500	35500	33500	33500	35500	31500	30000	31500	35500	35500	35500	35500	35500	35500	11200	22400
355 000	5 600	35500	35500	33500	30000	28000	28000	28000	31500	26500	25000	28000	33500	35500	35500	33500	31500	11200	22400	
	4 000	35500	35500	35500	35500	31500	30000	30000	31500	30000	28000	30000	33500	35500	35500	35500	33500	11200	22400	
450 000	5 600	33500	33500	30000	26500	25000	26500	26500	28000	25000	23600	25000	31500	35500	33500	30000	28000	10600	21200	
	4 000	33500	35500	35500	33500	30000	28000	28000	30000	26500	26500	28000	35500	35500	35500	31500	31500	11200	21200	
560 000	5 600	31500	31500	26500	23600	22400	23600	23600	26500	22400	21200	23600	28000	33500	31500	26500	23600	9000	19000	
	4 000	31500	33500	31500	30000	28000	25000	25000	28000	25000	23600	25000	30000	33500	35500	31500	28000	11200	20000	
710 000	5 600	30000	28000	22400	20000	19000	20000	22400	25000	20000	19000	21200	26500	30000	28000	23600	21200	7500	18000	
	4 000	28000	31500	28000	26500	25000	23600	23600	25000	22400	21200	23600	28000	31500	31500	30000	26500	11200	19000	
	2 800	28000	31500	31500	28000	26500	25000	25000	26500	25000	23600	25000	28000	31500	31500	30000	26500	11200	19000	
900 000	5 600	28000	25000	19000	17000	16000	17000	20000	22400	19000	17000	19000	25000	28000	25000	20000	18000	6000	16000	
	4 000	28000	30000	26500	23600	23600	22400	22400	23600	21200	20000	21200	25000	30000	30000	26500	25000	10000	17000	
	2 800	26500	28000	28000	26500	25000	23600	23600	25000	22400	21200	22400	26500	30000	30000	28000	25000	11200	18000	
1 120 000	4 000	25000	26500	23600	21200	20000	20000	20000	22400	19000	18000	20000	23600	28000	26500	23600	22400	8500	16000	
	2 800	25000	26500	28000	25000	23600	21200	21200	23600	21200	20000	21200	23600	28000	28000	26500	23600	11200	17000	
1 400 000	4 000	23600	23600	21200	19000	18000	18000	18000	20000	17000	16000	18000	22400	26500	23600	21200	20000	7500	15000	
	2 800	23600	25000	25000	22400	21200	20000	20000	21200	19000	18000	19000	22400	25000	26500	25000	22400	10000	15000	
1 800 000	4 000	22400	22400	19000	17000	16000	17000	17000	19000	16000	15000	16000	21200	23600	21200	19000	17000	6300	14000	
	2 800	22400	23600	22400	21200	20000	18000	18000	20000	18000	17000	18000	21200	25000	25000	23600	20000	9000	14000	
2 240 000	2 800	21200	22400	21200	19000	18000	17000	17000	18000	16000	15000	17000	20000	22400	22400	21200	19000	8000	13200	
	2 000	20000	22400	22400	20000	19000	18000	18000	19000	17000	17000	18000	20000	22400	23600	21200	19000	10000	14000	
2 800 000	2 800	19000	21200	19000	17000	16000	15000	15000	17000	15000	14000	15000	18000	21200	21200	19000	18000	7100	12500	
	2 000	19000	20000	20000	19000	17000	16000	16000	17000	16000	15000	16000	18000	21200	21200	20000	18000	9000	12500	
3 550 000	2 800	18000	19000	17000	15000	14000	14000	14000	16000	13200	12500	14000	17000	20000	19000	17000	16000	6000	11200	
	2 000	18000	19000	19000	18000	16000	15000	15000	16000	15000	14000	15000	17000	19000	20000	19000	17000	8000	11800	
4 500 000	2 800	17000	17000	15000	13200	12500	13200	13200	14000	12500	11800	12500	16000	19000	17000	15000	14000	5300	10600	
	2 000	17000	18000	18000	16000	15000	14000	14000	15000	13200	13200	14000	16000	18000	19000	18000	15000	7100	11200	
5 600 000	2 800	16000	15000	13200	11800	11200	11800	11800	13200	11200	10600	11800	15000	17000	15000	13200	12500	4500	9500	
	2 000	16000	17000	16000	15000	14000	13200	13200	14000	12500	11800	12500	15000	17000	18000	16000	14000	6300	10000	
max 35 500																	max 11 200	max 22 400		

Size **180**

280 000	8 000	45000	45000	45000	45000	45000	42500	40000	45000	40000	37500	40000	45000	45000	45000	45000	45000	14000	28000
	5 600	45000	45000	45000	45000	45000	45000	42500	45000	42500	40000	42500	45000	45000	45000	45000	45000	14000	28000
355 000	8 000	45000	45000	45000	42500	40000	37500	37500	42500	35500	33500	35500	45000	45000	45000	45000	45000	14000	28000
	5 600	45000	45000	45000	45000	45000	40000	40000	42500	40000	35500	40000	45000	45000	45000	45000	45000	14000	28000
450 000	8 000	45000	45000	45000	40000	35500	35500	35500	37500	33500	31500	33500	42500	45000	45000	40000	40000	14000	28000
	5 600	45000	45000	45000	45000	40000	37500	37500	40000	37500	35500	37500	42500	45000	45000	42500	42500	14000	28000
560 000	8 000	42500	45000	40000	35500	31500	31500	31500	35500	30000	28000	31500	37500	45000	45000	40000	35500	11800	25000
	5 600	42500	45000	45000	42500	37500	35500	33500	37500	33500	31500	33500	40000	45000	45000	40000	40000	14000	26500
710 000	8 000	40000	40000	35500	30000	28000	28000	28000	33500	28000	25000	28000	35500	42500	40000	35500	30000	10000	23600
	5 600	40000	42500	42500	37500	35500	31500	31500	33500	31500	28000	31500	37500	45000	45000	42500	35500	14000	25000
	4 000	40000	42500	42500	40000	35500	33500	33500	35500	33500	31500	33500	37500	42500	45000	42500	37500	14000	25000
900 000	8 000	37500	35500	30000	26500	23600	25000	26500	30000	25000	22400	25000	33500	40000	35500	31500	26500	8500	21200
	5 600	37500	40000	37500	33500	33500	30000	28000	31500	28000	26500	28000	33500	42500	42500	37500	33500	13200	22400
	4 000	37500	40000	40000	37500	33500	31500	31500	33500	30000	28000	31500	35500	40000	42500	40000	35500	14000	23600
1 120 000	5 600	33500	37500	35500	31500	30000	26500	26500	30000	26500	23600	26500	31500	40000	37500	35500	31500	11800	21200
	4 000	33500	37500	37500	35500	31500	28000	28000	31500	28000	26500	28000	33500	37500	40000	37500	31500	14000	22400
1 400 000	5 600	31500	33500	31500	28000	25000	25000	25000	26500	23600	21200	23600	30000	37500	35500	31500	28000	10000	19000
	4 000	31500	35500	35500	33500	28000	26500	26500	28000	25000	23600	26500	30000	35500	37500	35500	30000	13200	20000
1 800 000	5 600	30000	31500	28000	25000	22400	22400	22400	25000	21200	20000	22400	28000	35500	31500	28000	25000	8500	18000
	4 000	30000	33500	31500	30000	26500	26500	25000	26500	23600	22400	23600	28000	33500	35500	33500	28000	11800	19000
2 240 000	4 000	28000	31500	30000	26500	25000	22400	22400	25000	22400	20000	22400	26500	31500	33500	30000	26500	10600	17000
	2 800	28000	30000	30000	28000	25000	23600	23600	25000	23600	22400	23600	26500	30000	31500	30000	26500	13200	18000
2 800 000	4 000	26500	28000	26500	25000	23600	21200	20000	22400	20000	19000	20000	25000	30000	30000	26500	23600	9500	16000
	2 800	26500	28000	28000	26500	23600	22400	22400	23600	21200	20000	21200	25000	28000	30000	28000	25000	11800	17000
3 550 000	4 000	23600	26500	23600	22400	20000	19000	19000	21200	18000	17000	18000	22400	28000	26500	25000	22400	8000	15000
	2 800	23600	26500	26500	25000	22400	20000	20000	21200	20000	19000	20000	23600	26500	28000	26500			

16.2 - Axial loads F_{a2} [N] or radial loads F_{r2} [N] on low speed shaft end

Radial load applied on **groove side** ●

Size **160**

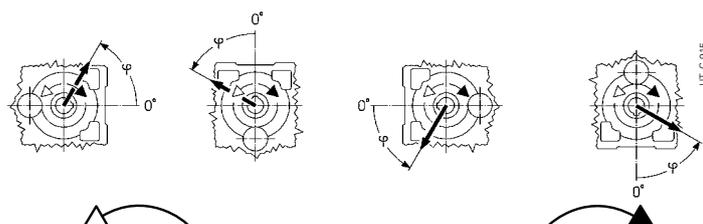
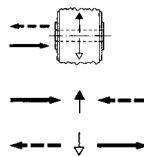
$n_2 \cdot L_h$		$F_{r2}^{1)2)3)}$												$F_{a2}^{1)}$					
																			
min ⁻¹ ·h	N m	0	45	90	135	180	225	270	315	0	45	90	135	180	225	270	315		
280 000	5 600	33500	35500	35500	35500	35500	25000	22400	25000	23600	19000	21200	28000	35500	35500	35500	35500	11200	22400
	4 000	35500	35500	35500	35500	35500	28000	26500	28000	28000	23600	25000	31500	35500	35500	35500	35500	11200	22400
355 000	5 600	30000	35500	35500	35500	31500	22400	20000	21200	21200	17000	18000	26500	35500	35500	35500	33500	11200	22400
	4 000	31500	35500	35500	35500	33500	26500	23600	25000	25000	21200	23600	30000	35500	35500	35500	33500	11200	22400
450 000	5 600	28000	35500	35500	35500	30000	20000	17000	19000	18000	14000	16000	23600	35500	35500	35500	30000	10600	21200
	4 000	30000	35500	35500	35500	31500	23600	21200	23600	23600	20000	21200	26500	35500	35500	35500	31500	11200	21200
560 000	5 600	25000	35500	35500	33500	26500	18000	15000	17000	16000	12500	13200	21200	35500	35500	35500	28000	9000	19000
	4 000	28000	35500	35500	35500	28000	22400	19000	21200	21200	17000	19000	25000	35500	35500	35500	30000	11200	20000
710 000	5 600	22400	33500	35500	31500	22400	16000	13200	15000	13200	10000	11200	18000	33500	35500	25000	25000	7500	18000
	4 000	25000	33500	35500	33500	26500	20000	17000	19000	19000	15000	16000	22400	33500	35500	28000	28000	11200	19000
900 000	2 800	26500	31500	35500	33500	28000	22400	20000	22400	22400	19000	20000	25000	31500	35500	28000	28000	11200	19000
	5 600	20000	31500	33500	28000	20000	14000	11200	13200	11200	8500	9500	16000	31500	35500	31500	22400	6000	16000
1 120 000	4 000	23600	31500	35500	31500	25000	18000	16000	17000	17000	13200	15000	20000	31500	35500	25000	25000	10000	17000
	2 800	25000	30000	33500	31500	25000	20000	19000	20000	20000	17000	18000	22400	30000	35500	33500	26500	11200	18000
1 400 000	4 000	21200	30000	31500	28000	22400	16000	14000	15000	15000	11800	13200	19000	28000	35500	31500	23600	8500	16000
	2 800	22400	28000	31500	30000	23600	19000	17000	18000	18000	15000	16000	21200	28000	33500	31500	25000	11200	17000
1 800 000	4 000	19000	28000	30000	26500	21200	14000	11800	14000	13200	10000	11200	16000	26500	33500	30000	21200	7500	15000
	2 800	21200	26500	30000	28000	22400	17000	15000	16000	16000	14000	15000	19000	26500	31500	30000	22400	10000	15000
2 240 000	4 000	18000	26500	28000	23600	19000	12500	10600	11800	11200	8500	9500	15000	25000	31500	26500	20000	6300	14000
	2 800	19000	25000	28000	26500	20000	16000	14000	15000	15000	12500	13200	18000	25000	30000	28000	21200	9000	14000
2 800 000	2 800	18000	23600	26500	23600	19000	14000	12500	14000	13200	11200	11800	16000	23600	28000	26500	19000	8000	13200
	2 000	19000	22400	25000	23600	19000	16000	14000	15000	15000	13200	14000	18000	22400	26500	25000	20000	10000	14000
3 550 000	2 800	16000	22400	25000	22400	17000	12500	11200	12500	11800	9500	10600	14000	22400	26500	25000	18000	7100	12500
	2 000	17000	21200	23600	22400	18000	14000	13200	14000	14000	11800	12500	16000	21200	25000	23600	19000	9000	12500
4 500 000	2 800	15000	21200	22400	20000	16000	11200	10000	11200	10600	8500	9000	13200	20000	25000	22400	16000	6000	11200
	2 000	16000	20000	22400	21200	17000	13200	11800	12500	12500	10600	11800	15000	20000	23600	22400	17000	8000	11800
5 600 000	2 800	14000	20000	21200	19000	15000	10000	8500	10000	9500	7100	8000	11800	19000	23600	21200	15000	5300	10600
	2 000	15000	19000	21200	20000	15000	11800	10600	11800	11800	10000	10600	13200	19000	22400	21200	16000	7100	11200
5 600 000	2 800	12500	19000	20000	17000	13200	9000	7500	8500	8000	6000	6700	10600	18000	21200	19000	14000	4500	9500
	2 000	14000	18000	20000	19000	14000	11200	9500	10600	10600	8500	9000	12500	18000	21200	20000	15000	6300	10000
max 35 500																		max 11 200	max 22 400

Size **180**

280 000	8 000	45000	45000	45000	45000	45000	35500	31500	33500	33500	26500	30000	40000	45000	45000	45000	45000	14000	28000
	5 600	45000	45000	45000	45000	45000	40000	37500	40000	40000	33500	35500	45000	45000	45000	45000	45000	14000	28000
355 000	8 000	42500	45000	45000	45000	42500	31500	28000	31500	30000	23600	25000	37500	45000	45000	45000	45000	14000	28000
	5 600	45000	45000	45000	45000	45000	37500	33500	35500	35500	30000	31500	40000	45000	45000	45000	45000	14000	28000
450 000	8 000	37500	45000	45000	45000	40000	28000	25000	28000	26500	21200	22400	33500	45000	45000	45000	40000	14000	28000
	5 600	40000	45000	45000	45000	42500	33500	30000	33500	31500	28000	30000	37500	45000	45000	45000	42500	14000	28000
560 000	8 000	35500	45000	45000	45000	37500	25000	21200	25000	22400	18000	20000	30000	45000	45000	45000	37500	11800	25000
	5 600	37500	45000	45000	45000	40000	30000	28000	30000	28000	25000	26500	33500	45000	45000	45000	40000	14000	26500
710 000	8 000	31500	45000	45000	42500	31500	22400	19000	21200	20000	15000	17000	26500	45000	45000	45000	33500	10000	23600
	5 600	35500	45000	45000	45000	35500	28000	25000	26500	26500	21200	23600	31500	45000	45000	45000	37500	14000	25000
900 000	4 000	35500	42500	45000	45000	37500	31500	28000	30000	30000	26500	28000	33500	42500	45000	45000	37500	14000	25000
	8 000	28000	42500	45000	37500	28000	20000	16000	19000	17000	12500	14000	23600	42500	45000	45000	31500	8500	21200
1 120 000	5 600	31500	42500	45000	42500	33500	25000	22400	25000	23600	19000	21200	28000	42500	45000	45000	33500	13200	22400
	4 000	33500	40000	45000	42500	35500	28000	26500	28000	28000	23600	25000	31500	40000	45000	35500	35500	14000	23600
1 400 000	5 600	30000	40000	45000	40000	31500	22400	20000	22400	21200	17000	19000	26500	40000	45000	45000	31500	11800	21200
	4 000	31500	37500	42500	40000	31500	26500	23600	25000	25000	21200	23600	28000	37500	45000	42500	33500	14000	22400
1 800 000	5 600	26500	37500	40000	35500	28000	20000	17000	20000	18000	15000	16000	23600	37500	45000	40000	28000	10000	19000
	4 000	28000	35500	40000	37500	30000	23600	21200	23600	22400	19000	20000	26500	35500	42500	40000	30000	13200	20000
2 240 000	5 600	25000	35500	37500	33500	26500	18000	15000	17000	16000	12500	14000	21200	35500	42500	37500	26500	8500	18000
	4 000	26500	33500	37500	35500	28000	21200	19000	21200	20000	17000	19000	25000	33500	40000	37500	28000	11800	19000
2 800 000	4 000	25000	31500	35500	33500	25000	20000	17000	19000	19000	15000	17000	22400	31500	37500	35500	26500	10600	17000
	2 800	25000	31500	33500	31500	26500	22400	20000	21200	21200	19000	20000	23600	31500	35500	33500	26500	13200	18000
3 550 000	4 000	22400	30000	33500	30000	23600	18000	16000	17000	17000	14000	15000	20000	30000	35500	33500	25000	9500	16000
	2 800	23600	28000	31500	30000	25000	20000	18000	20000	20000	17000	18000	22400	28000	33500	31500	25000	11800	17000
4 500 000	4 000	21200	28000	31500	28000	22400	16000	14000	15000	15000	11800	13200	18000	28000	33500	31500	22400	8000	15000
	2 800	22																	

16.2 - Axial loads F_{a2} [N] or radial loads F_{r2} [N] on low speed shaft end

Radial load applied on **opposite side to groove**

Size **200**

$n_2 \cdot L_h$		$F_{r2}^{1)2)3)}$												$F_{a2}^{1)}$							
min ⁻¹ ·h	N m	0	45	90	135	180	225	270	315	0	45	90	135	180	225	270	315				
280 000	11 200	47500	56000	56000	56000	56000	56000	50000	45000	56000	56000	50000	50000	50000	53000	56000	56000	35500	18000		
	8 000	53000	56000	56000	56000	56000	56000	56000	53000	50000	56000	56000	53000	53000	56000	56000	56000	35500	18000		
355 000	11 200	45000	50000	56000	56000	56000	56000	45000	40000	56000	53000	47500	47500	45000	47500	56000	56000	35500	17000		
	8 000	47500	56000	56000	56000	56000	56000	50000	45000	56000	53000	50000	50000	53000	56000	56000	56000	35500	18000		
450 000	11 200	40000	42500	50000	56000	56000	53000	42500	37500	56000	47500	42500	42500	40000	42500	50000	56000	33500	14000		
	8 000	45000	50000	56000	56000	56000	53000	45000	42500	56000	50000	45000	45000	50000	53000	56000	56000	33500	18000		
560 000	11 200	35500	37500	42500	50000	56000	47500	37500	33500	53000	45000	40000	35500	33500	37500	42500	50000	31500	11800		
	8 000	40000	47500	53000	56000	56000	50000	42500	37500	53000	45000	42500	42500	45000	47500	53000	56000	31500	18000		
710 000	11 200	33500	31500	37500	45000	50000	45000	33500	30000	47500	40000	35500	30000	28000	31500	37500	45000	28000	9500		
	8 000	37500	45000	47500	53000	53000	45000	37500	35500	50000	42500	37500	37500	40000	42500	47500	53000	30000	16000		
900 000	11 200	26500	26500	31500	35000	40000	45000	31500	28000	42500	37500	33500	25000	23600	26500	33500	40000	26500	7500		
	8 000	33500	40000	42500	47500	50000	42500	35500	31500	45000	40000	35500	35500	35500	37500	42500	47500	28000	14000		
1 120 000	11 200	26500	26500	31500	35000	40000	45000	31500	28000	42500	37500	33500	25000	23600	26500	33500	40000	26500	7500		
	8 000	33500	40000	42500	47500	50000	42500	35500	31500	45000	40000	37500	37500	40000	45000	47500	47500	28000	18000		
1 400 000	11 200	26500	26500	31500	35000	40000	45000	31500	30000	42500	37500	33500	25000	23600	26500	33500	40000	26500	7500		
	8 000	33500	40000	45000	47500	47500	40000	33500	33500	42500	37500	35500	35500	37500	42500	45000	45000	26500	17000		
1 800 000	11 200	28000	30000	33500	40000	42500	37500	30000	26500	40000	33500	30000	30000	28000	30000	33500	37500	23600	10000		
	8 000	31500	35500	42500	45000	42500	37500	31500	30000	40000	33500	31500	31500	35500	37500	40000	42500	23600	15000		
2 240 000	11 200	26500	26500	30000	35500	40000	33500	26500	23600	37500	31500	28000	25000	23600	26500	31500	35500	22400	8500		
	8 000	28000	33500	37500	42500	40000	35500	30000	28000	37500	33500	30000	30000	33500	33500	37500	40000	22400	13200		
2 800 000	11 200	26500	26500	31500	35000	40000	45000	31500	28000	42500	37500	33500	25000	23600	26500	33500	40000	20000	10000		
	8 000	26500	30000	33500	35500	35500	30000	26500	25000	31500	28000	26500	26500	28000	31500	33500	33500	20000	13200		
3 550 000	11 200	22400	25000	28000	31500	33500	28000	22400	21200	30000	26500	23600	23600	22400	23600	28000	30000	18000	8500		
	8 000	23600	28000	31500	33500	33500	28000	25000	22400	30000	26500	25000	25000	26500	28000	31500	31500	18000	11800		
4 500 000	11 200	20000	22400	25000	28000	31500	26500	21200	19000	28000	23600	21200	21200	20000	21200	25000	28000	17000	7100		
	8 000	22400	25000	30000	31500	31500	26500	22400	21200	28000	25000	23600	23600	25000	26500	28000	30000	17000	10600		
5 600 000	11 200	18000	19000	21200	25000	28000	23600	19000	17000	26500	22400	20000	18000	17000	19000	22400	25000	15000	6000		
	8 000	20000	23600	26500	30000	28000	25000	21200	19000	26500	23600	21200	21200	22400	23600	26500	28000	16000	9000		
max 56 000																		max 35 500		max 18 000	

Values valid for solid low speed shaft⁴⁾ (see ch. 17).

Size **225**

280 000	16 000	67000	71000	71000	71000	71000	71000	71000	63000	71000	71000	71000	71000	71000	71000	71000	71000	45000	22400
	11 200	71000	71000	71000	71000	71000	71000	71000	71000	71000	71000	71000	71000	71000	71000	71000	71000	45000	22400
355 000	16 000	63000	71000	71000	71000	71000	71000	63000	56000	71000	71000	67000	67000	67000	71000	71000	71000	45000	22400
	11 200	67000	71000	71000	71000	71000	71000	67000	63000	71000	71000	71000	71000	71000	71000	71000	71000	45000	22400
450 000	16 000	56000	67000	71000	71000	71000	71000	60000	53000	71000	67000	60000	60000	60000	63000	71000	71000	42500	20000
	11 200	63000	71000	71000	71000	71000	71000	63000	60000	71000	71000	63000	63000	71000	71000	71000	71000	45000	22400
560 000	16 000	53000	56000	63000	71000	71000	67000	53000	47500	71000	63000	56000	53000	50000	56000	63000	71000	40000	17000
	11 200	56000	67000	71000	71000	71000	71000	67000	60000	53000	71000	63000	60000	60000	63000	71000	71000	42500	22400
710 000	16 000	47500	50000	56000	67000	71000	63000	47500	42500	67000	56000	50000	45000	42500	47500	57000	63000	37500	13200
	11 200	53000	63000	71000	71000	71000	63000	53000	50000	67000	60000	56000	56000	60000	63000	67000	71000	37500	21200
900 000	11 200	42500	42500	50000	60000	67000	56000	45000	40000	63000	53000	45000	37500	37500	42500	50000	57000	35500	11200
	8 000	47500	56000	63000	71000	71000	60000	50000	45000	63000	56000	50000	50000	53000	56000	63000	71000	35500	19000
1 120 000	11 200	45000	53000	56000	63000	67000	56000	45000	40000	60000	50000	47500	47500	47500	50000	56000	63000	33500	16000
	8 000	47500	56000	63000	67000	63000	56000	50000	45000	60000	53000	50000	50000	53000	60000	63000	63000	33500	22400
1 400 000	11 200	40000	45000	50000	56000	63000	50000	40000	37500	56000	47500	42500	42500	40000	45000	50000	56000	31500	14000
	8 000	45000	50000	60000	63000	60000	53000	45000	42500	56000	50000	45000	45000	50000	53000	60000	60000	33500	20000
1 800 000	11 200	37500	40000	45000	53000	56000	47500	37500	33500	53000	45000	40000	37500	35500	40000	45000	50000	28000	11800
	8 000	40000	47500	56000	60000	56000	50000	42500	37500	53000	45000	42500	42500	45000	50000	53000	56000	30000	17000
2 240 000	11 200	37500	45000	50000	56000	53000	45000	37500	35500	47500	42500	37500	37500	42500	45000	50000	53000	28000	15000
	8 000	40000	45000	50000	53000	53000	45000	40000	37500	47500	42500	40000	40000	42500	47500	50000	50000	28000	20000
2 800 000	11 200	33500	40000	45000	50000	50000	42500	35500	31500	45000	40000	35500	35500	37500	40000	45000	50000	25000	13200
	8 000	37500	42500	47500	50000	47500	42500	37500	35500	45000	40000	37500	37500	40000	45000	47500	47500	26500	17000
3 550 000	11 200	31500	37500	40000	45000	47500	40000	31500	28000	42500	35500	33500	33500	33500	35000	40000	45000	23600	11200
	8 000	33500	37500	45000	47500	45000	40000	33500	31500	42500	37500	35500	35500	37500	42500	45000	45000	23600	16000
4 500 000	11 200	28000	33500	35500	42500	45000	37500	30000	26500	40000	33500	30000	30000	28000	31500	35500	40000	22400	10000
	8 000	31500	35500	42500	45000	42500	37500	31500	30000	40000	35500	31500	31500	35500	37500	42500	42500	22400	14000
5 600 000	11 200	26500	28000	31500	37500	40000	33500	26500	23600	37500	31500								

16.2 - Axial loads F_{a2} [N] or radial loads F_{r2} [N] on low speed shaft end

Radial load applied on **groove side** ●

Size **200**

$n_2 \cdot L_h$	$F_{r2}^{1) 2) 3)}$	$F_{a2}^{1)}$																	
		UT. C 915																	
min ⁻¹ ·h	N m	0	45	90	135	180	225	270	315	0	45	90	135	180	225	270	315		
280 000	11 200	37500	56000	56000	56000	56000	50000	33500	31500	56000	40000	37500	42500	56000	56000	56000	56000	35500	18000
	8 000	47500	56000	56000	56000	56000	53000	42500	40000	56000	47500	45000	47500	56000	56000	56000	56000	35500	18000
355 000	11 200	33500	53000	56000	56000	56000	45000	30000	28000	50000	37500	33500	37500	53000	56000	56000	56000	35500	17000
	8 000	42500	56000	56000	56000	56000	50000	37500	35500	53000	42500	40000	45000	56000	56000	56000	56000	35500	18000
450 000	11 200	30000	50000	56000	56000	56000	40000	26500	23600	47500	33500	30000	33500	45000	56000	56000	56000	33500	14000
	8 000	37500	53000	56000	56000	56000	45000	35500	31500	50000	40000	35500	40000	50000	56000	56000	56000	33500	18000
560 000	11 200	26500	45000	56000	56000	56000	35500	22400	20000	42500	30000	25000	30000	40000	53000	56000	56000	31500	11800
	8 000	33500	47500	56000	56000	56000	42500	31500	28000	45000	35500	31500	35500	47500	56000	56000	56000	31500	18000
710 000	11 200	22400	40000	56000	56000	56000	31500	19000	17000	37500	25000	22400	26500	33500	47500	56000	56000	28000	9500
	8 000	30000	45000	56000	56000	56000	37500	28000	25000	42500	31500	28000	33500	42500	56000	56000	56000	30000	16000
900 000	8 000	35500	47500	56000	56000	53000	42500	33500	31500	45000	37500	33500	37500	45000	56000	53000	53000	30000	18000
	5 600	19000	33500	50000	56000	53000	26500	16000	14000	35500	22400	19000	23600	28000	42500	53000	50000	26500	7500
1 120 000	8 000	28000	42500	56000	56000	53000	35500	25000	22400	40000	30000	26500	30000	40000	50000	56000	53000	28000	14000
	5 600	33500	42500	56000	56000	50000	37500	30000	28000	40000	33500	31500	33500	42500	50000	56000	50000	28000	18000
1 120 000	8 000	25000	37500	53000	56000	50000	31500	21200	20000	35500	26500	23600	26500	37500	45000	53000	50000	25000	11800
	5 600	30000	40000	53000	56000	47500	35500	28000	26500	37500	31500	28000	31500	40000	47500	53000	47500	26500	17000
1 400 000	8 000	21200	35500	47500	53000	45000	28000	18000	17000	33500	23600	20000	23600	31500	42500	47500	47500	23600	10000
	5 600	26500	37500	47500	53000	45000	31500	25000	22400	35500	28000	25000	28000	35500	45000	50000	45000	23600	15000
1 800 000	8 000	18000	31500	42500	50000	42500	25000	16000	14000	30000	21200	18000	21200	28000	37500	45000	42500	22400	8500
	5 600	25000	33500	45000	50000	42500	30000	22400	20000	33500	25000	23600	26500	33500	42500	47500	42500	22400	13200
2 240 000	5 600	22400	31500	42500	47500	40000	26500	20000	18000	30000	23600	21200	23600	31500	37500	42500	40000	21200	11800
	4 000	25000	33500	40000	42500	37500	30000	23600	22400	31500	26500	23600	26500	31500	37500	42500	37500	21200	14000
2 800 000	5 600	20000	30000	40000	45000	37500	25000	17000	16000	28000	21200	19000	21200	28000	35500	40000	37500	19000	10000
	4 000	23600	30000	37500	40000	35500	26500	21200	20000	28000	23600	22400	23600	30000	35500	40000	35500	20000	13200
3 550 000	5 600	17000	26500	37500	40000	35500	22400	15000	14000	25000	19000	16000	19000	26500	31500	37500	35500	18000	8500
	4 000	21200	28000	37500	40000	33500	25000	19000	18000	26500	21200	20000	22400	28000	33500	37500	33500	18000	11800
4 500 000	5 600	15000	25000	33500	37500	31500	20000	13200	11800	23600	17000	15000	17000	23600	30000	33500	33500	17000	7100
	4 000	19000	26500	35500	37500	31500	22400	17000	16000	25000	20000	18000	20000	25000	31500	35500	31500	17000	10600
5 600 000	5 600	13200	22400	30000	35500	30000	18000	11200	10000	21200	15000	12500	15000	20000	26500	31500	30000	15000	6000
	4 000	17000	23600	33500	35500	30000	21200	15000	14000	23600	18000	16000	18000	23600	30000	33500	30000	16000	9000
max 56 000																	max 35 500	max 18 000	

Values valid for solid low speed shaft⁴⁾ (see ch. 17).

Size **225**

280 000	16 000	56000	71000	71000	71000	71000	71000	53000	47500	71000	60000	56000	63000	71000	71000	71000	71000	45000	22400	
	11 200	67000	71000	71000	71000	71000	71000	63000	60000	71000	67000	63000	67000	71000	71000	71000	71000	45000	22400	
355 000	16 000	50000	71000	71000	71000	71000	63000	45000	42500	71000	56000	50000	56000	71000	71000	71000	71000	45000	22400	
	11 200	60000	71000	71000	71000	71000	71000	56000	53000	71000	63000	56000	63000	71000	71000	71000	71000	45000	22400	
450 000	16 000	45000	71000	71000	71000	71000	60000	40000	37500	67000	50000	45000	50000	67000	71000	71000	71000	42500	20000	
	11 200	56000	71000	71000	71000	71000	67000	50000	47500	71000	56000	53000	56000	71000	71000	71000	71000	45000	22400	
560 000	16 000	40000	63000	71000	71000	71000	53000	35500	31500	63000	45000	40000	45000	60000	71000	71000	71000	40000	17000	
	11 200	50000	67000	71000	71000	71000	60000	45000	42500	67000	53000	47500	53000	67000	71000	71000	71000	42500	22400	
710 000	16 000	35500	56000	71000	71000	71000	47500	30000	26500	56000	40000	33500	40000	50000	67000	71000	71000	37500	13200	
	11 200	45000	63000	71000	71000	71000	56000	40000	37500	60000	47500	42500	47500	63000	71000	71000	71000	37500	21200	
900 000	8 000	50000	63000	71000	71000	71000	60000	47500	45000	63000	53000	50000	53000	63000	71000	71000	71000	40000	22400	
	5 600	30000	50000	71000	71000	71000	42500	26500	23600	53000	35500	30000	35500	45000	60000	71000	71000	35500	11200	
1 120 000	11 200	40000	60000	71000	71000	71000	50000	37500	33500	56000	42500	40000	42500	56000	71000	71000	71000	35500	19000	
	8 000	47500	60000	71000	71000	71000	56000	45000	42500	56000	47500	45000	50000	60000	71000	71000	71000	37500	22400	
1 120 000	11 200	35500	53000	71000	71000	71000	67000	45000	33500	30000	53000	40000	35500	40000	53000	63000	71000	71000	33500	16000
	8 000	42500	56000	71000	71000	71000	67000	50000	40000	37500	53000	45000	40000	45000	56000	67000	67000	33500	22400	
1 400 000	11 200	31500	50000	67000	71000	63000	40000	28000	25000	47500	35500	31500	35500	47500	56000	67000	67000	31500	14000	
	8 000	37500	53000	67000	71000	63000	47500	35500	33500	50000	40000	37500	40000	50000	63000	67000	63000	33500	20000	
1 800 000	11 200	28000	45000	60000	71000	60000	37500	25000	22400	45000	31500	28000	31500	40000	53000	63000	60000	28000	11800	
	8 000	35500	47500	63000	67000	56000	42500	31500	30000	45000	37500	33500	37500	47500	60000	63000	60000	30000	17000	
2 240 000	8 000	31500	45000	60000	63000	56000	40000	30000	26500	42500	33500	31500	33500	42500	56000	60000	56000	28000	15000	
	5 600	37500	45000	56000	60000	53000	42500	33500	33500	45000	37500	35500	37500	45000	53000	56000	53000	28000	20000	
2 800 000	8 000	28000	40000	56000	63000	50000	35500	26500	23600	40000	30000	28000	31500	40000	50000	56000	53000	25000	13200	
	5 600	33500	42500	53000	56000	50000	37500	31500	30000	40000	33500	31500	35500	42500	50000	53000	50000	26500	17000	
3 550 000	8 000	25000	37500	53000	56000	47500	31500	22400	21200	37500	28000	25000	28000	37500	45000	50000	50000	23600	11200	
	5 600	30000</																		

16.2 - Axial loads F_{a2} [N] or radial loads F_{r2} [N] on low speed shaft end

Radial load applied on **opposite side to groove**

Size **250**

$n_2 \cdot L_h$		$F_{r2}^{1)2)3)}$									$F_{a2}^{1)}$												
		min ⁻¹ ·h		N m		0	45	90	135	180	225	270	315	0	45	90	135	180	225	270	315		
280 000	22 400	90000	90000	90000	90000	90000	90000	90000	90000	90000	90000	90000	85000	80000	85000	90000	90000	90000	90000	90000	90000	28000	56000
	16 000	90000	90000	90000	90000	90000	90000	90000	90000	90000	90000	90000	90000	85000	90000	90000	90000	90000	90000	90000	90000	28000	56000
355 000	22 400	90000	90000	90000	90000	85000	80000	80000	90000	75000	71000	80000	90000	90000	90000	90000	90000	90000	90000	90000	28000	56000	
	16 000	90000	90000	90000	90000	90000	85000	85000	90000	85000	80000	85000	90000	90000	90000	90000	90000	90000	90000	90000	28000	56000	
450 000	22 400	90000	90000	90000	80000	75000	75000	75000	85000	71000	67000	71000	90000	90000	90000	90000	90000	90000	85000	28000	56000		
	16 000	90000	90000	90000	90000	85000	80000	80000	85000	75000	71000	80000	90000	90000	90000	90000	90000	90000	90000	28000	56000		
560 000	22 400	90000	90000	80000	71000	63000	67000	67000	75000	63000	60000	67000	85000	90000	90000	90000	80000	71000	25000	53000			
	16 000	90000	90000	90000	85000	80000	71000	71000	80000	71000	67000	71000	85000	90000	90000	90000	80000	63000	28000	56000			
710 000	22 400	85000	80000	71000	60000	56000	60000	63000	71000	60000	53000	60000	75000	90000	90000	80000	71000	63000	21200	50000			
	16 000	85000	90000	85000	75000	71000	67000	67000	75000	63000	63000	67000	80000	90000	90000	85000	75000	28000	53000				
900 000	22 400	80000	71000	63000	53000	47500	50000	56000	67000	57000	50000	56000	71000	80000	75000	63000	50000	17000	47500				
	16 000	75000	85000	75000	71000	67000	63000	63000	67000	60000	56000	60000	71000	85000	85000	80000	71000	26500	47500				
1 120 000	22 400	75000	80000	80000	75000	71000	67000	67000	71000	63000	60000	63000	75000	85000	85000	80000	71000	28000	47500				
	16 000	71000	75000	71000	63000	60000	56000	56000	63000	53000	53000	56000	67000	80000	80000	71000	63000	23600	45000				
1 400 000	22 400	71000	75000	75000	71000	63000	60000	60000	63000	60000	56000	60000	71000	80000	80000	75000	67000	28000	45000				
	16 000	67000	71000	71000	67000	60000	56000	56000	60000	50000	47500	53000	63000	75000	71000	63000	60000	21200	40000				
1 800 000	22 400	63000	67000	67000	60000	50000	47500	50000	53000	45000	42500	47500	60000	71000	63000	56000	53000	18000	37500				
	16 000	63000	67000	67000	60000	56000	53000	53000	56000	50000	47500	50000	60000	67000	71000	67000	56000	25000	40000				
2 240 000	22 400	60000	63000	60000	53000	53000	47500	47500	53000	47500	45000	47500	56000	63000	63000	63000	53000	22400	35500				
	16 000	60000	60000	60000	56000	53000	50000	50000	53000	50000	47500	50000	56000	63000	63000	60000	53000	26500	37500				
2 800 000	22 400	53000	60000	53000	50000	47500	45000	45000	47500	42500	40000	42500	53000	60000	60000	56000	50000	19000	33500				
	16 000	53000	56000	56000	53000	50000	47500	47500	50000	45000	42500	47500	53000	60000	60000	56000	50000	23600	35500				
3 550 000	22 400	50000	53000	50000	45000	42500	40000	40000	45000	37500	35500	40000	47500	56000	56000	50000	45000	17000	31500				
	16 000	50000	53000	53000	50000	45000	42500	42500	47500	42500	40000	42500	47500	53000	53000	50000	45000	22400	31500				
4 500 000	22 400	47500	50000	45000	40000	37500	37500	37500	42500	35500	33500	35500	45000	53000	50000	45000	42500	15000	30000				
	16 000	47500	50000	50000	47500	42500	40000	40000	42500	37500	37500	40000	45000	53000	53000	50000	45000	20000	30000				
5 600 000	22 400	45000	45000	40000	35500	31500	33500	33500	37500	31500	30000	33500	42500	50000	45000	40000	35500	12500	26500				
	16 000	45000	47500	47500	42500	40000	35500	35500	40000	35500	33500	35500	42500	47500	50000	47500	40000	18000	28000				
max 90 000											max 28 000		max 56 000										

Values valid for solid low speed shaft⁴⁾ (see ch. 17).

Size **280**

280 000	31 500	112000	112000	112000	112000	112000	112000	112000	112000	112000	106000	112000	112000	112000	112000	112000	112000	112000	35500	71000
	22 400	112000	112000	112000	112000	112000	112000	112000	112000	112000	112000	112000	112000	112000	112000	112000	112000	112000	35500	71000
355 000	31 500	112000	112000	112000	112000	112000	106000	106000	112000	100000	95000	106000	112000	112000	112000	112000	112000	112000	35500	71000
	22 400	112000	112000	112000	112000	112000	112000	112000	112000	112000	106000	112000	112000	112000	112000	112000	112000	112000	35500	71000
450 000	31 500	112000	112000	112000	112000	106000	100000	100000	106000	95000	90000	95000	112000	112000	112000	112000	112000	112000	35500	71000
	22 400	112000	112000	112000	112000	112000	106000	106000	112000	100000	95000	106000	112000	112000	112000	112000	112000	112000	35500	71000
560 000	31 500	112000	112000	112000	100000	95000	90000	90000	100000	85000	80000	85000	106000	112000	112000	112000	100000	33500	67000	
	22 400	112000	112000	112000	112000	106000	95000	95000	106000	95000	90000	95000	112000	112000	112000	112000	106000	33500	67000	
710 000	31 500	112000	112000	100000	90000	80000	85000	80000	90000	80000	71000	80000	100000	112000	112000	100000	90000	28000	60000	
	22 400	106000	112000	112000	106000	100000	90000	90000	95000	85000	80000	85000	100000	112000	112000	112000	100000	35500	63000	
900 000	22 400	106000	112000	112000	112000	100000	95000	95000	100000	90000	90000	95000	106000	112000	112000	112000	100000	35500	63000	
	16 000	100000	106000	106000	100000	95000	85000	85000	90000	85000	80000	85000	95000	106000	112000	112000	100000	35500	60000	
1 120 000	22 400	95000	106000	95000	90000	85000	75000	75000	80000	71000	67000	75000	90000	106000	112000	100000	85000	31500	56000	
	16 000	95000	100000	100000	95000	85000	80000	80000	85000	80000	75000	80000	90000	100000	106000	100000	90000	35500	56000	
1 400 000	22 400	90000	95000	85000	80000	75000	71000	67000	75000	67000	63000	67000	80000	100000	100000	90000	80000	26500	50000	
	16 000	90000	100000	90000	85000	80000	71000	71000	75000	71000	67000	71000	85000	95000	100000	95000	80000	35500	53000	
1 800 000	22 400	85000	85000	80000	71000	63000	63000	63000	71000	60000	56000	63000	75000	95000	90000	80000	71000	23600	47500	
	16 000	80000	90000	90000	85000	75000	67000	67000	75000	67000	63000	67000	80000	90000	95000	90000	75000	31500	47500	
2 240 000	22 400	75000	85000	85000	75000	71000	63000	63000	67000	63000	56000	63000	75000	85000	90000	85000	71000	28000	45000	
	16 000	75000	80000	80000	75000	71000	67000	67000	71000	67000	63000	67000	75000	80000	85000	80000	71000	33500	45000	
2 800 000	22 400	71000	80000	75000	67000	63000	56000	56000	63000	56000	53000	56000	67000	80000	85000	75000	67000	25000	42500	
	16 000	71000	75000	75000	71000	67000	60000	60000	63000	60000	56000	60000	67000	75000	80000	75000	67000	31500	42500	
3 550 000	22 400	67000	75000	67000	63000	60000	53000	53000	56000	50000	47500	53000	63000	75000	75000	71000	63000	22400	37500	
	16 000	67000	71000	71000	67000	60000	56000	56000	60000	56000	53000	56000	63000	71000	75000	71000	63000	28000	40000	
4 500 000	22 400	63000	67000	63000	56000	53000	50000	50000	53000	47500	45000	47500	60000	71000	71000	63000	56000	19000</		

16.2 - Axial loads F_{a2} [N] or radial loads F_{r2} [N] on low speed shaft end

Radial load applied on **groove side** ●

Size **250**

$n_2 \cdot L_h$	$F_{r2}^{1) 2) 3)}$														$F_{a2}^{1)}$				
	min ⁻¹ ·h	N m																	
		0	45	90	135	180	225	270	315	0	45	90	135	180	225	270	315		
280 000	22 400	90000	90000	90000	90000	90000	75000	67000	75000	71000	60000	63000	85000	90000	90000	90000	90000	28000	56000
	16 000	90000	90000	90000	90000	90000	85000	75000	85000	80000	71000	75000	75000	90000	90000	90000	90000	28000	56000
355 000	22 400	90000	90000	90000	90000	90000	67000	60000	67000	63000	50000	56000	75000	90000	90000	90000	90000	28000	56000
	16 000	90000	90000	90000	90000	90000	75000	71000	75000	75000	63000	67000	85000	90000	90000	90000	90000	28000	56000
450 000	22 400	80000	90000	90000	90000	85000	60000	53000	60000	56000	45000	50000	71000	90000	90000	90000	85000	28000	56000
	16 000	85000	90000	90000	90000	90000	71000	63000	71000	67000	60000	63000	80000	90000	90000	90000	90000	28000	56000
560 000	22 400	75000	90000	90000	90000	75000	53000	47500	53000	50000	37500	42500	63000	90000	90000	90000	80000	25000	53000
	16 000	80000	90000	90000	90000	80000	63000	60000	63000	60000	53000	56000	71000	90000	90000	90000	85000	28000	56000
710 000	22 400	67000	90000	90000	85000	67000	47500	42500	47500	42500	33500	35500	56000	90000	90000	90000	71000	21200	50000
	16 000	71000	90000	90000	90000	75000	60000	53000	56000	56000	47500	50000	67000	90000	90000	90000	75000	28000	53000
900 000	22 400	63000	90000	90000	80000	56000	42500	35500	42500	35500	28000	31500	50000	90000	90000	90000	63000	17000	47500
	16 000	67000	90000	90000	90000	71000	53000	47500	53000	50000	42500	45000	60000	90000	90000	90000	71000	26500	47500
1 120 000	22 400	63000	85000	90000	80000	63000	47500	42500	47500	45000	37500	40000	56000	85000	90000	90000	67000	23600	45000
	16 000	67000	80000	90000	80000	67000	53000	50000	53000	53000	47500	50000	60000	80000	90000	85000	67000	28000	45000
1 400 000	22 400	56000	80000	85000	75000	60000	42500	37500	42500	40000	31500	35500	50000	75000	90000	85000	60000	21200	40000
	16 000	60000	75000	80000	75000	63000	50000	45000	50000	47500	40000	45000	56000	75000	85000	80000	63000	26500	42500
1 800 000	22 400	47500	75000	75000	67000	53000	37500	33500	37500	35500	28000	30000	45000	71000	85000	75000	56000	18000	37500
	16 000	56000	71000	75000	71000	56000	47500	40000	45000	42500	37500	40000	53000	71000	80000	75000	60000	25000	40000
2 240 000	22 400	53000	67000	75000	67000	53000	42500	37500	40000	40000	33500	35500	47500	67000	80000	71000	53000	22400	35500
	16 000	53000	63000	67000	63000	53000	47500	42500	45000	45000	40000	42500	50000	63000	71000	67000	56000	26500	37500
2 800 000	22 400	47500	63000	71000	63000	50000	37500	33500	37500	35500	30000	31500	42500	63000	75000	67000	50000	19000	33500
	16 000	50000	60000	63000	60000	50000	42500	37500	42500	40000	37500	37500	47500	60000	67000	63000	53000	23600	35500
3 550 000	22 400	45000	60000	63000	56000	45000	33500	30000	33500	31500	26500	28000	40000	60000	71000	63000	47500	17000	31500
	16 000	47500	56000	63000	56000	47500	37500	35500	37500	37500	31500	33500	42500	56000	63000	60000	47500	22400	31500
4 500 000	22 400	40000	56000	60000	53000	42500	30000	26500	30000	28000	22400	25000	35500	53000	67000	60000	42500	15000	30000
	16 000	42500	53000	60000	53000	45000	35500	31500	35500	33500	30000	31500	40000	53000	60000	56000	45000	20000	30000
5 600 000	22 400	37500	53000	53000	47500	37500	26500	23600	26500	25000	20000	21200	31500	50000	63000	53000	40000	12500	26500
	16 000	40000	50000	56000	50000	40000	31500	30000	31500	30000	26500	28000	35500	50000	60000	53000	42500	18000	28000
max 90 000																	max 28 000	max 56 000	

Values valid for solid low speed shaft⁴⁾ (see ch. 17).

Size **280**

280 000	31 500	112000	112000	112000	112000	112000	100000	90000	100000	95000	80000	85000	112000	112000	112000	112000	112000	35500	71000
	22 400	112000	112000	112000	112000	112000	112000	106000	112000	112000	95000	100000	112000	112000	112000	112000	112000	35500	71000
355 000	31 500	112000	112000	112000	112000	112000	90000	80000	90000	85000	71000	75000	106000	112000	112000	112000	112000	35500	71000
	22 400	112000	112000	112000	112000	112000	100000	95000	100000	100000	85000	90000	112000	112000	112000	112000	112000	35500	71000
450 000	31 500	106000	112000	112000	112000	112000	80000	71000	80000	75000	63000	67000	95000	112000	112000	112000	112000	35500	71000
	22 400	112000	112000	112000	112000	112000	95000	85000	90000	90000	80000	85000	106000	112000	112000	112000	112000	35500	71000
560 000	31 500	100000	112000	112000	112000	106000	75000	63000	71000	67000	53000	56000	85000	112000	112000	112000	106000	33500	67000
	22 400	106000	112000	112000	112000	106000	85000	75000	85000	80000	71000	75000	95000	112000	112000	112000	112000	35500	67000
710 000	31 500	90000	112000	112000	112000	95000	67000	56000	63000	60000	45000	50000	75000	112000	112000	112000	95000	28000	60000
	22 400	95000	112000	112000	112000	100000	80000	71000	75000	75000	63000	67000	90000	112000	112000	112000	106000	35500	63000
900 000	22 400	100000	112000	112000	112000	100000	85000	80000	85000	85000	75000	80000	95000	112000	112000	112000	106000	35500	63000
	16 000	80000	112000	112000	112000	80000	56000	50000	56000	50000	40000	42500	67000	112000	112000	112000	90000	23600	56000
1 120 000	22 400	90000	112000	112000	112000	95000	71000	63000	67000	67000	56000	60000	80000	112000	112000	112000	95000	35500	60000
	16 000	95000	112000	112000	112000	95000	80000	75000	80000	75000	67000	71000	90000	112000	112000	112000	100000	35500	60000
1 400 000	22 400	85000	112000	112000	112000	85000	63000	56000	63000	60000	50000	53000	75000	106000	112000	112000	90000	31500	56000
	16 000	85000	106000	112000	106000	90000	75000	67000	71000	71000	63000	67000	80000	106000	112000	112000	90000	35500	56000
1 800 000	22 400	75000	106000	112000	100000	80000	56000	50000	56000	53000	42500	47500	67000	100000	112000	112000	80000	26500	50000
	16 000	75000	100000	112000	106000	80000	60000	53000	60000	63000	56000	60000	75000	100000	112000	106000	85000	35500	53000
2 240 000	22 400	71000	100000	106000	95000	75000	53000	45000	50000	47500	37500	40000	60000	95000	112000	106000	75000	23600	47500
	16 000	75000	95000	106000	95000	75000	60000	56000	60000	56000	50000	53000	67000	95000	112000	100000	80000	31500	47500
2 800 000	22 400	67000	90000	100000	90000	71000	56000	50000	53000	53000	45000	47500	63000	85000	106000	95000	75000	28000	45000
	16 000	71000	85000	90000	85000	75000	63000	56000	60000	60000	53000	56000	67000	85000	95000	90000	75000	33500	45000
3 550 000	22 400	63000	80000	95000	85000	67000	50000	45000	50000	47500	40000	42500	56000	80000	100000	90000	67000	25000	42500
	16 000	67000	80000	85000	80000	67000	56000	50000	56000	56000	47500	50000	63000	80000	90000	85000	67000	31500	42500
4 500 000	22 400	60000	80000	85000	80000	60000	45000	40000	45000	42500	35500	37500	53000	75000	95000	85000	63000	22400	37500
	16 000	60000	75000	80000	75000	63000	50000	47500	50000	50000	42500	45000	56000	75000	85000	80000	63000	28000	40000
5 600 000	22 400	53000																	

16.2 - Axial loads F_{a2} [N] or radial loads F_{r2} [N] on low speed shaft end

Radial load applied on **opposite side to groove**

Sizes **320, 321**

$n_2 \cdot L_h$	min ⁻¹ ·h	N m	$F_{r2}^{1)2)3)}$										$F_{a2}^{1)}$								
			0	45	90	135	180	225	270	315	0	45	90	135	180	225	270	315			
2 800 000	45 000		132000	140000	140000	140000	140000	140000	140000	132000	118000	140000	140000	132000	132000	140000	140000	140000	140000	90000	45000
	31 500		140000	140000	140000	140000	140000	140000	140000	140000	132000	140000	140000	140000	140000	140000	140000	140000	140000	90000	45000
3 550 000	45 000		118000	140000	140000	140000	140000	140000	140000	118000	112000	140000	132000	125000	125000	132000	132000	140000	140000	85000	45000
	31 500		132000	140000	140000	140000	140000	140000	140000	132000	125000	140000	140000	132000	132000	140000	140000	140000	140000	90000	45000
4 500 000	45 000		106000	125000	140000	140000	140000	140000	140000	112000	100000	140000	125000	112000	118000	112000	125000	140000	140000	80000	37500
	31 500		118000	140000	140000	140000	140000	140000	140000	118000	112000	140000	132000	125000	125000	132000	140000	140000	140000	85000	45000
5 600 000	45 000		100000	112000	118000	140000	140000	125000	100000	90000	140000	118000	106000	106000	100000	106000	125000	140000	75000	31500	
	31 500		112000	125000	140000	140000	140000	132000	112000	106000	140000	118000	112000	112000	125000	132000	140000	140000	75000	45000	
7 100 000	45 000		90000	95000	106000	125000	132000	118000	90000	80000	132000	106000	95000	90000	85000	95000	112000	125000	67000	25000	
	31 500		100000	118000	132000	140000	140000	118000	100000	95000	125000	112000	106000	106000	112000	118000	132000	140000	71000	42500	
9 000 000	45 000		80000	80000	85000	95000	112000	125000	112000	85000	75000	118000	100000	85000	75000	71000	80000	95000	112000	63000	20000
	31 500		90000	112000	125000	132000	132000	112000	95000	85000	118000	106000	95000	95000	106000	106000	118000	132000	67000	37500	
11 200 000	45 000		85000	100000	112000	125000	125000	106000	85000	80000	112000	95000	90000	90000	95000	100000	106000	118000	60000	31500	
	22 400		90000	106000	118000	125000	118000	106000	90000	85000	112000	100000	95000	95000	100000	112000	118000	118000	63000	42500	
14 000 000	31 500		75000	90000	95000	112000	118000	95000	80000	71000	106000	90000	80000	80000	80000	85000	95000	106000	56000	26500	
	22 400		85000	95000	112000	118000	112000	100000	85000	80000	100000	90000	85000	85000	95000	106000	112000	112000	60000	37500	
18 000 000	31 500		71000	80000	85000	100000	106000	90000	71000	63000	100000	80000	75000	75000	71000	75000	80000	100000	53000	22400	
	22 400		75000	90000	106000	112000	106000	90000	80000	71000	95000	85000	80000	80000	85000	95000	100000	106000	53000	33500	
22 400 000	22 400		71000	85000	95000	106000	100000	85000	71000	67000	90000	80000	75000	75000	80000	85000	95000	100000	50000	30000	
	16 000		75000	85000	95000	100000	95000	85000	75000	71000	90000	80000	75000	75000	85000	90000	95000	95000	53000	37500	
28 000 000	22 400		63000	75000	85000	95000	95000	80000	67000	60000	85000	75000	67000	67000	75000	75000	85000	95000	47500	25000	
	16 000		71000	80000	90000	95000	90000	80000	71000	67000	85000	75000	71000	71000	75000	85000	90000	90000	47500	33500	
35 500 000	22 400		60000	71000	75000	85000	90000	75000	60000	56000	80000	67000	63000	63000	63000	67000	75000	85000	42500	22400	
	16 000		63000	75000	85000	90000	85000	75000	67000	63000	80000	71000	67000	67000	71000	80000	85000	85000	45000	30000	
45 000 000	22 400		56000	63000	67000	75000	85000	67000	56000	50000	75000	63000	56000	56000	56000	60000	67000	75000	40000	19000	
	16 000		60000	67000	80000	85000	80000	71000	60000	56000	75000	67000	60000	63000	67000	75000	80000	80000	42500	26500	
56 000 000	22 400		50000	56000	60000	71000	75000	63000	50000	45000	67000	56000	53000	53000	50000	53000	63000	67000	37500	16000	
	16 000		56000	63000	75000	80000	75000	63000	56000	53000	67000	60000	56000	56000	63000	67000	71000	75000	37500	23600	
max 140 000																	max 90 000		max 45 000		

Values valid for solid low speed shaft⁴⁾ (see ch. 17).

Sizes **360**

280 000	63 000	180000	180000	180000	180000	180000	180000	180000	180000	170000	180000	180000	180000	180000	180000	180000	180000	180000	112000	56000
	45 000	180000	180000	180000	180000	180000	180000	180000	180000	180000	180000	180000	180000	180000	180000	180000	180000	180000	112000	56000
355 000	63 000	160000	180000	180000	180000	180000	180000	180000	160000	150000	180000	180000	170000	170000	180000	180000	180000	180000	112000	56000
	45 000	170000	180000	180000	180000	180000	180000	180000	180000	170000	180000	180000	180000	180000	180000	180000	180000	180000	112000	56000
450 000	63 000	150000	180000	180000	180000	180000	180000	180000	150000	140000	180000	170000	150000	160000	170000	180000	180000	180000	112000	56000
	45 000	160000	180000	180000	180000	180000	180000	180000	160000	150000	180000	180000	160000	170000	180000	180000	180000	180000	112000	56000
560 000	63 000	132000	160000	180000	180000	180000	170000	140000	125000	180000	160000	140000	140000	140000	160000	180000	180000	106000	50000	
	45 000	150000	170000	180000	180000	180000	180000	150000	140000	180000	160000	150000	150000	170000	180000	180000	180000	106000	56000	
710 000	63 000	125000	140000	160000	180000	180000	160000	125000	112000	170000	140000	132000	132000	125000	140000	160000	180000	95000	42500	
	45 000	132000	160000	180000	180000	180000	160000	140000	125000	170000	150000	140000	140000	150000	170000	180000	180000	100000	56000	
900 000	31 500	140000	160000	180000	180000	180000	160000	150000	140000	170000	160000	150000	150000	160000	170000	180000	180000	106000	56000	
	63 000	112000	125000	140000	160000	180000	150000	112000	100000	160000	132000	118000	118000	112000	125000	140000	160000	90000	35500	
1 120 000	45 000	125000	150000	170000	180000	180000	150000	125000	118000	160000	140000	132000	132000	140000	150000	170000	180000	95000	56000	
	31 500	132000	150000	170000	180000	170000	150000	132000	132000	160000	140000	140000	140000	150000	160000	170000	170000	95000	56000	
1 400 000	45 000	112000	140000	160000	170000	170000	140000	118000	106000	150000	132000	118000	118000	132000	140000	150000	170000	85000	47500	
	31 500	125000	140000	160000	170000	160000	140000	125000	118000	150000	132000	125000	125000	140000	150000	160000	160000	90000	56000	
1 800 000	45 000	106000	125000	140000	160000	160000	132000	106000	95000	140000	118000	106000	112000	118000	125000	140000	150000	80000	40000	
	31 500	112000	132000	150000	160000	150000	132000	118000	106000	140000	125000	118000	118000	125000	140000	150000	150000	80000	56000	
2 240 000	45 000	95000	112000	125000	140000	150000	125000	95000	90000	132000	112000	100000	100000	100000	112000	125000	140000	75000	35500	
	31 500	106000	125000	140000	150000	140000	125000	106000	100000	132000	118000	106000	106000	118000	132000	140000	140000	75000	50000	
2 800 000	31 500	95000	112000	132000	140000	132000	118000	100000	90000	125000	106000	100000	100000	112000	118000	132000	132000	71000	45000	
	22 400	100000	118000	132000	140000	132000	118000	106000	100000	118000	112000	106000	106000	112000	125000	132000	132000	75000	56000	
3 550 000	31 500	90000	106000	125000	132000	125000	106000	90000	85000	112000	100000	90000	90000	100000	112000					

16.2 - Axial loads F_{a2} [N] or radial loads F_{r2} [N] on low speed shaft end

Radial load applied on **groove side** ●

Sizes **320, 321**

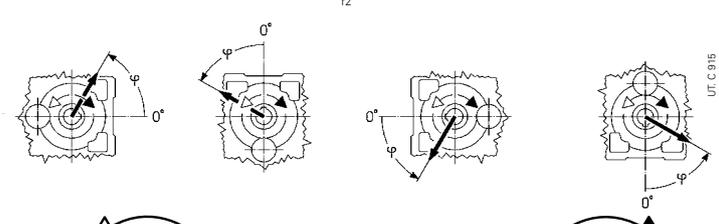
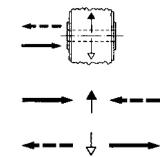
$n_2 \cdot L_h$		$F_{r2}^{1) 2) 3)}$												$F_{a2}^{1)}$						
																				
min ⁻¹ ·h	N m	0	45	90	135	180	225	270	315	0	45	90	135	180	225	270	315			
280 000	45 000	106000	140000	140000	140000	140000	140000	125000	90000	85000	140000	106000	100000	112000	140000	140000	140000	140000	90000	45000
	31 500	125000	140000	140000	140000	140000	140000	140000	140000	112000	106000	140000	125000	118000	132000	140000	140000	140000	90000	45000
355 000	45 000	95000	140000	140000	140000	140000	140000	118000	80000	75000	132000	95000	85000	100000	140000	140000	140000	85000	45000	
	31 500	112000	140000	140000	140000	140000	140000	132000	100000	95000	140000	112000	106000	118000	140000	140000	140000	90000	45000	
450 000	45 000	80000	132000	140000	140000	140000	140000	106000	71000	63000	118000	85000	75000	90000	132000	140000	140000	80000	37500	
	31 500	106000	140000	140000	140000	140000	140000	118000	95000	85000	132000	106000	95000	106000	140000	140000	140000	85000	45000	
560 000	45 000	71000	125000	140000	140000	140000	140000	90000	60000	53000	112000	75000	67000	80000	118000	140000	140000	75000	31500	
	31 500	95000	132000	140000	140000	140000	140000	112000	85000	75000	118000	95000	85000	95000	125000	140000	140000	75000	45000	
710 000	45 000	60000	112000	140000	140000	140000	140000	80000	50000	45000	100000	67000	56000	71000	100000	140000	140000	67000	25000	
	31 500	85000	118000	140000	140000	140000	140000	100000	75000	67000	112000	85000	75000	90000	118000	140000	140000	71000	42500	
900 000	45 000	50000	100000	140000	140000	140000	140000	71000	42500	37500	90000	56000	50000	63000	90000	125000	140000	63000	20000	
	31 500	75000	112000	140000	140000	140000	140000	132000	90000	67000	100000	75000	71000	80000	106000	140000	140000	67000	37500	
1 120 000	45 000	90000	118000	140000	140000	140000	140000	132000	100000	80000	106000	90000	80000	90000	112000	140000	140000	67000	45000	
	31 500	67000	106000	140000	140000	140000	140000	125000	80000	56000	95000	67000	63000	71000	100000	132000	140000	60000	31500	
1 400 000	45 000	80000	106000	140000	140000	140000	140000	125000	90000	71000	67000	100000	80000	75000	85000	106000	132000	63000	42500	
	31 500	56000	95000	132000	140000	118000	75000	50000	45000	85000	60000	53000	63000	90000	118000	132000	56000	26500		
1 800 000	45 000	71000	100000	132000	140000	118000	85000	63000	60000	90000	71000	67000	75000	95000	118000	132000	60000	37500		
	31 500	50000	85000	125000	140000	112000	67000	42500	40000	80000	53000	47500	56000	85000	106000	125000	53000	22400		
2 240 000	45 000	67000	90000	125000	132000	112000	75000	56000	56000	85000	67000	60000	67000	90000	118000	125000	53000	33500		
	31 500	60000	85000	118000	125000	100000	71000	53000	50000	80000	60000	56000	63000	85000	106000	118000	50000	30000		
2 800 000	45 000	67000	90000	106000	112000	100000	75000	63000	60000	80000	67000	63000	71000	85000	100000	112000	53000	37500		
	31 500	53000	80000	112000	118000	95000	63000	45000	42500	71000	53000	50000	56000	75000	100000	112000	47500	25000		
3 550 000	45 000	63000	80000	100000	106000	95000	71000	56000	53000	75000	63000	60000	63000	80000	95000	106000	47500	33500		
	31 500	47500	71000	100000	112000	90000	56000	40000	37500	67000	47500	42500	50000	71000	90000	100000	42500	22400		
4 500 000	45 000	56000	75000	95000	100000	85000	67000	50000	50000	71000	56000	53000	60000	75000	90000	100000	45000	30000		
	31 500	40000	67000	95000	106000	85000	53000	35500	31500	60000	42500	37500	45000	67000	85000	95000	40000	19000		
5 600 000	45 000	53000	71000	90000	95000	80000	60000	47500	45000	67000	53000	47500	53000	67000	85000	95000	42500	26500		
	31 500	35500	60000	85000	95000	80000	47500	30000	28000	56000	37500	33500	40000	60000	75000	85000	37500	16000		
		47500	67000	85000	90000	75000	56000	42500	40000	60000	47500	42500	50000	63000	80000	90000	37500	23600		
max 140 000																	max 90 000	max 45 000		

Values valid for solid low speed shaft⁴⁾ (see ch. 17).

Sizes **360**

280 000	63 000	150000	180000	180000	180000	180000	180000	180000	132000	125000	180000	150000	140000	160000	180000	180000	180000	180000	112000	56000
	45 000	170000	180000	180000	180000	180000	180000	180000	160000	150000	180000	170000	160000	180000	180000	180000	180000	180000	112000	56000
355 000	63 000	132000	180000	180000	180000	180000	160000	118000	106000	180000	140000	125000	140000	180000	180000	180000	180000	112000	56000	
	45 000	160000	180000	180000	180000	180000	180000	140000	132000	180000	160000	150000	160000	180000	180000	180000	180000	112000	56000	
450 000	63 000	118000	180000	180000	180000	180000	150000	106000	95000	170000	125000	112000	125000	180000	180000	180000	180000	112000	56000	
	45 000	140000	180000	180000	180000	180000	170000	132000	125000	180000	140000	132000	150000	180000	180000	180000	180000	112000	56000	
560 000	63 000	106000	170000	180000	180000	180000	132000	90000	80000	150000	112000	100000	112000	160000	180000	180000	180000	106000	50000	
	45 000	132000	180000	180000	180000	180000	150000	118000	112000	170000	132000	118000	132000	170000	180000	180000	180000	106000	56000	
710 000	63 000	90000	150000	180000	180000	180000	118000	75000	71000	140000	100000	85000	100000	150000	180000	180000	180000	95000	42500	
	45 000	118000	160000	180000	180000	180000	140000	106000	95000	150000	118000	106000	125000	160000	180000	180000	180000	100000	56000	
900 000	63 000	132000	170000	180000	180000	180000	150000	125000	118000	160000	132000	125000	132000	160000	180000	180000	180000	106000	56000	
	45 000	75000	140000	180000	180000	180000	106000	67000	60000	132000	85000	75000	90000	132000	170000	180000	180000	90000	35500	
1 120 000	45 000	106000	150000	180000	180000	180000	125000	95000	85000	140000	106000	106000	112000	150000	180000	180000	180000	95000	56000	
	31 500	125000	150000	180000	180000	180000	140000	112000	106000	150000	125000	118000	125000	150000	180000	180000	180000	95000	56000	
1 400 000	45 000	95000	140000	180000	180000	170000	118000	85000	75000	132000	100000	90000	100000	132000	180000	180000	180000	85000	47500	
	31 500	112000	140000	180000	180000	170000	132000	100000	95000	140000	112000	106000	118000	140000	170000	180000	170000	90000	56000	
1 800 000	45 000	80000	125000	180000	180000	160000	106000	71000	67000	118000	85000	75000	90000	125000	160000	180000	170000	80000	40000	
	31 500	100000	132000	170000	180000	160000	118000	90000	85000	125000	100000	95000	106000	132000	160000	170000	160000	80000	56000	
2 240 000	45 000	71000	118000	170000	180000	150000	95000	63000	56000	112000	80000	67000	80000	118000	150000	170000	160000	75000	35500	
	31 500	90000	125000	160000	170000	150000	106000	85000	75000	118000	95000	85000	95000	118000	150000	160000	150000	75000	50000	
2 800 000	45 000	85000	118000	150000	160000	140000	100000	75000	71000	106000	85000	80000	85000	112000	140000	160000	140000	71000	45000	
	31 500	95000	118000	140000	150000	132000	106000	85000	85000	112000	95000	90000	95000	118000	140000	150000	132000	75000	56000	
3 550 000	45 000	75000	106000	140000	160000	132000	90000	67000	63000	100000	75000	71000	80000	106000	132000	150000	132000	67000	40000	
	31 500	85000	112000																	

This page is intentionally left blank.

17 – Accessories and non-standard designs

Overview	322
(1) Low speed shaft (sizes 40 ... 360)	323
(2) Solid low speed shaft (sizes 100 ... 360)	324
(3) Oversized hollow low speed shaft (sizes 40, 50, 64, 100).....	324
(4) Hollow low speed shaft with front holes (sizes 250 ... 360).....	325
(5) Stepped hollow low speed shaft (sizes 64 ... 360)	325
(6) Hollow low speed shaft with shrink disc (sizes 40 ... 360).....	326
(7) Protection for hollow low speed shaft with shrink disc (sizes 140 ... 360)	328
(8) Flange (sizes 40 ... 360).....	329
(9) Backstop device (sizes 50 ... 360)	330
(10) Reaction bolt using disc spring (sizes 40 ... 360)	331
(11) Kit using reaction disc springs (sizes 40 ... 125)	332
(12) Reaction bolt using disc springs with bracket (sizes 63 ... 225)	333
(13) Rigid or flexible torque arm using bracket (sizes 63 ... 225)	334
(14) Torque arm (sizes 40 ... 81)	335
(15) Fan cooling (sizes 125 ... 360).....	336
(16) Water cooling by coil (sizes 125 ... 360).....	338
(17) Cooling by internal exchanger (sizes 140 ... 360).....	338
(18) Additional oversized housing hole for oil pipe cooling (sizes 160 ... 360).....	339
(19) Bearing lubrication pump (sizes 100 ... 360)	340
(20) Hollow low speed shaft washer (sizes 40 ... 360)	340
(21) Hollow low speed shaft washer with locking rings or bushing (sizes 40 ... 360)	340
(22) Hollow low speed shaft protection (sizes 40 ... 360).....	340
(23) Design for agitators, aerators, fans (sizes 125 ... 360)	341
(24) Optional paint (sizes 40 ... 360).....	342
(25) Heater (sizes 125 ... 360).....	343
(26) Seals on high and low speed shafts (sizes 125 ... 360).....	344
(27) Magnetic tap (sizes 125 ... 360)	345
(28) Oil drain tap (sizes 125 ... 360)	345
(29) Independent cooling unit	346
(30) Oil temperature probe (sizes 125 ... 360)	348
(31) Oil temperature probe with terminal box and amperometric transducer 4 ÷ 20 mA (sizes 125 ... 360).....	349
(32) Bearing temperature probe (sizes 125 ... 360).....	350
(33) Bearing temperature probe with terminal box and amperometric transducer 4 ÷ 20 mA (sizes 125 ... 360)	351
(34) Bi-metal type thermostat (sizes 100 ... 360)	352
(35) Oil level switch with float (sizes 125 ... 360).....	352
(36) Oil optical probe (sizes 125 ... 360).....	352
(37)  Gear reducer design ATEX II 2 GD and 3 GD (sizes 40 ... 360).....	353
(38) NEMA C-Face adapter (IEC motor sizes 63 ... 100)	355
Miscellaneous.....	356

17 - Accessories and non-standard designs

Overview

Ref.	Description	Size	Designation
(1)	Low speed shaft	40 ... 360 40 ... 360	standard low speed shaft double extension low speed shaft
(2)	Solid low speed shaft	100 ... 360	solid low speed shaft on opposite groove side solid low speed shaft on groove side solid double extension low speed shaft
(3)	Oversized hollow low speed shaft	40, 50, 64, 100	oversized hollow low speed shaft
(4)	Hollow low speed shaft with front holes	250 ... 360	hollow low speed shaft with front holes
(5)	Stepped hollow low speed shaft	64 ... 360	stepped hollow low speed shaft
(6)	Hollow low speed shaft with shrink disc	40 ... 125 140 ... 360 140 ... 360	hollow low speed shaft with shrink disc hollow low speed shaft with shrink disc on machine side hollow low speed shaft with shrink disc on machine opp. side
(7)	Protection for hollow low speed shaft with shrink disc	140 ... 360	protection for shrink disc
(8)	Flange	40 ... 360 63 ... 81	flange B5 flange B5 type B
(9)	Backstop device	50 ... 360	backstop device free rotation white arrow backstop device free rotation black arrow
(10)	Reaction bolt using disc springs	40 ... 360	reaction bolt using disc springs
(11)	Kit using disc springs	40 ... 125	kit using disc springs
(12)	Reaction bolt using disc springs and bracket	63 ... 225	reaction bolt using disc springs and bracket
(13)	Rigid or flexible torque arm using bracket	63 ... 225	rigid torque arm using bracket flexible torque arm using bracket
(14)	Torque arm	40 ... 81	torque arm
(15)	Fan cooling	125 ... 360	fan cooling fan cooling pos. 1 fan cooling pos. 2 fan cooling pos. 1 and 2
(16)	Water cooling by coil	125 ... 360	water cooling by coil water cooling by coil and thermostatic valve
(17)	Independent cooling unit with internal heat exchanger	140 ... 360	Independent cooling unit with internal heat exchanger
(18)	Additional housing hole with oversized for pipe oil cooling	160 ... 360	additional housing hole with oversized diameter
(19)	Bearing lubrication pump	100 ... 360 100 ... 360	bearing lubrication pump high speed shaft lubrication device
(20)	Hollow low speed shaft washer	40 ... 360	hollow low speed shaft washer
(21)	Hollow low speed shaft washer with locking rings or bushing	40 ... 360	hollow low speed shaft washer with locking rings or bushing
(22)	Hollow low speed shaft protection cap	40 ... 360	hollow low speed shaft protection cap
(23)	Design for agitators, aerators, fans	125 ... 360	design for agitators
(24)	Option paint	40 ... 360	option paint 1HRAL 5010 option paint 2HRAL 5010 option paint 3HRAL 5010 option paint 2IRAL 5010 option paint 2LRAL 5010
(25)	Heater	125 ... 360	heater
(26)	Seals on high and low speed shafts	125 ... 360	
(27)	Magnetic oil drain plug	125 ... 360	oil drain magnetic plug
(28)	Oil drain tap	125 ... 360	oil drain tap
(29)	Independent cooling unit	-	independent cooling unit oil-air UR O/A ... independent cooling unit oil-water UR O/W ... independent cooling unit oil-air UR O/A ... and bearing and/or gear forced lubrication ... independent cooling unit oil-water UR O/W ... and bearing and/or gear forced lubrication ...
(30)	Oil temperature probe	125 ... 360	oil temperature probe
(31)	Oil temperature probe with terminal box and amperometric transducer	200 ... 360	oil temperature probe with amperometric transducer
(32)	Bearing temperature probe	200 ... 360	bearing temperature probe
(33)	Bearing temperature probe with terminal box and amperometric transducer	200 ... 360	bearing temperature probe with amperometric transducer
(34)	Bi-metal type thermostat	100 ... 360	bi-metal type thermostat
(35)	Oil level switch with float	125 ... 360	oil level switch with float
(36)	Oil optical probe	125 ... 360	oil optical probe
(37)	Gear reducer design ATEX II 2 GD and 3 GD	40 ... 360 40 ... 360 125 ... 360	design ATEX II 3 GD T4 design ATEX II 2 GD T4 monthly control design ATEX II 2 GD T4 quarterly control
(38)	NEMA C-Face adapter	IEC 63 ... 100	MPN... (see table)

17 - Accessories and non-standard designs

(1) Low speed shaft (sizes 40 ... 360)

This accessory is mounted on the gear reducer. The standard mounting position is with shaft and on opposite side to groove. For opposite mounting position, when possible (for some helical gearmotors MR 2I 40 ... 81 and MR 3I 40 ... 125, the low speed shaft cannot overhang from motor side: consult us), state after the designation «groove side assembly».

The external diameter of the element or of the spacer abutting with the gear reducer must be $(1,25 \div 1,4) \cdot D$; hole tolerance D H7 ... K7.

Other dimensions at ch. 6 «High and low speed shaft end».

Supplementary description when ordering by **designation: standard** or **double extension low speed shaft**.

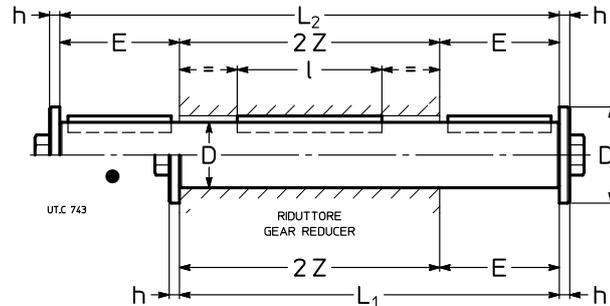

- Position of the reference groove (see ch. 16) for radial load verification.

Gear red. size	D ∅	E	D ₁ ∅	h	L ₁	L ₂	l	2 Z	Screw UNI 5737-88	kg	
										Standard	Double ext.
40	19 h7	30	28	4	122	152	50	92	M 6×20	0,3	0,4
50	24 h7	36 ³⁾	35	5	142	178	63	106	M 8×25	0,6	0,7
63	30 h7	58 ³⁾	47	5	184	242	63	126	M 10×30	1	1,3
64	32 h7	58 ³⁾	47	5	184	242	70	126	M 10×30	1,2	1,5
80	38 h7	58	47	5	208	266	90	150	M 10×30	1,9	2,4
81	40 h7	58	47	5	208	266	90	150	M 10×30	2,1	2,7
100	48 h7	82	57	6	262	344	110	180	M 12×40	3,7	4,9
125	60 h7	97 ¹⁾	82	8	317	422	140	220	M 16×45	7	9,4
140	70 h7	105	82	8	355	460	180	250	M 16×45	11	14
160	80 h7	130	102	10	402	532	200	272	M 20×60	18	24
180	90 h7	130	102	10	430	560	200	300	M 20×60	21	28
200	100 j6	165	135	12	499	664	250	334	M 24×60	36	46
225	110 j6	165	135	12	525	690	250	360	M 24×60	39	51
250	125 j6	200 ²⁾	160	16	612	812	320	412	M 30×70	62	83
280	140 j6	200	160	16	644	844	320	444	M 30×70	82	106
320,321	160 j6	240	205	20	748	988	400	508	M 36×90	125	165
360	180 j6	240	205	20	786	1026	400	546	M 36×90	166	216

1) Value **not** to standard; with double extension low speed shaft E = 101.

2) Value **not** to standard.

3) For MR 3I the dimension E increases of 1.

17 - Accessories and non-standard designs

(2) Solid low speed shaft (sizes 100 ... 360)

Gear reducers and gearmotors sizes 100 ... 360 can be supplied with solid low speed shaft overhanging from groove opposite side, from groove side or from double extension. For sizes 225, 280, and 360 the design foresees oversized bearings in order to allow high radial loads stated on ch. 16.

Other dimensions at ch. 6 «High and low speed shaft end».

1) As alternative to the (not double extension) solid low speed shaft, for sizes 64 ... 81 it is possible to supply the standard low speed shaft axially fastened; the fastening is realized with retaining ring and the dimension E (see ch. 17 (1)) increases by 8 mm: consult us.

Supplementary description when ordering by **designation: solid low speed shaft opposite to groove side** or **groove side** or **double extension**.

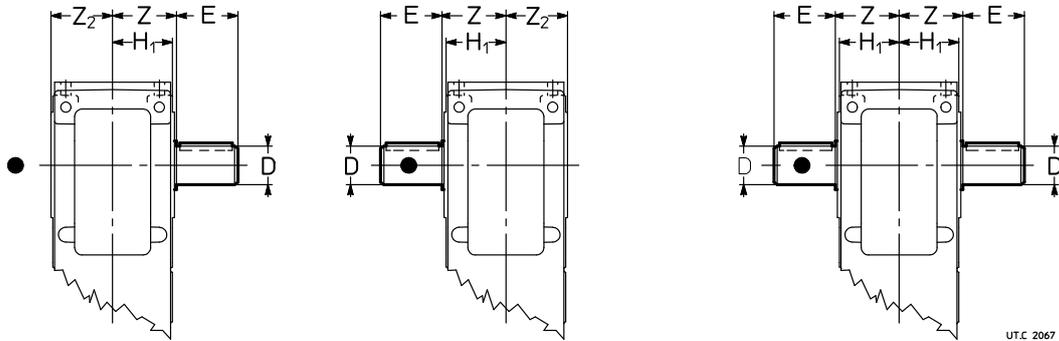

● Position of the reference groove (see ch. 8, 10, 12, 14).

Gear reducer size	D ∅ k6	E	Z	Z ₂	H ₁
100	48	82	90	88	84,5
125	60	105	110	108	103,5
140	70	105	125	122	103,5
160	80	130	136	133	128,5
180	90	130	150	148	128,5
200	100	165	167	165	158
225	110	165	180	177	158
250	125	200 ¹⁾	206	204	195
280	140	200	222	219	195
320, 321	160	240	254	251	241
360	180	240	273	270	241

1) Value **not** to standard.

(3) Oversized hollow low speed shaft (sizes 40, 50, 64, 100)

The gear reducers and gearmotors sizes 40, 50, 64 and 100 can be supplied with oversized hollow low speed shaft; dimensions are according to following table; hollow low speed shaft washer is not available.

Supplementary description when ordering by **designation: oversized hollow low speed shaft**.

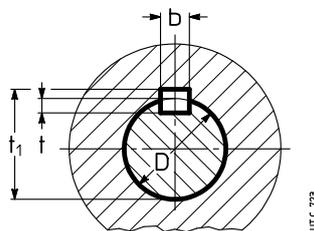

Gear reducer size	D ∅ H7	Parallel key b × h × l*	Keyway		
			b	t	t₁
40	20	6 × 6 × 50	6	4,5 ¹⁾	22,2 ¹⁾
50	25	8 × 7 × 63	8	4,5 ¹⁾	27,7 ¹⁾
64	35 ²⁾	10 × 8 × 90	10	6,5 ¹⁾	36,8 ¹⁾
100	50	14 × 9 × 125	14	6,5 ¹⁾	52,8 ¹⁾

* Recommended length.

1) Values **not** to standard.

2) Without retaining ring groove.

17 - Accessories and non-standard designs

(4) Hollow low speed shaft with front holes (sizes 250 ... 360)

Hollow low speed shaft, sizes 250 ... 360, including tapped holes. The dimensions of tapped holes and the maximum axial force deriving from relevant screws class 8.8 are stated in the table.

ATTENTION. This axial load can be insufficient to assure the disassembly of gear reducer from machine shaft end. In fact, according to the selected coupling tolerances to realize the machine shaft end and according to the coupling status – determined by installation environment and duty cycle (e.g.: alternate cycles, with overloads, etc.) – the disassembly operation could require an extraction force even much higher than the thread capacity that could be damaged irremediably.

In these cases, it is necessary to adopt an extraction system through hollow low speed shaft bushing (see ch. 17 (20)).

Supplementary description when ordering by **designation: hollow low speed shaft with front holes.**

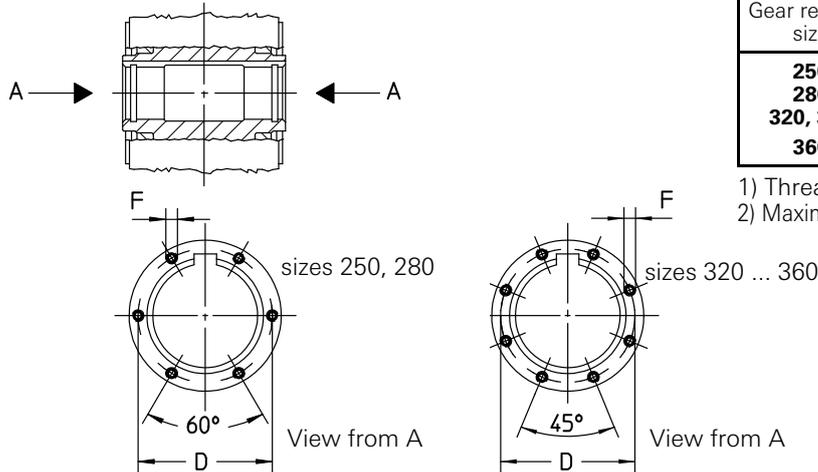

Gear reducer size	D Ø	F ¹⁾		α [°]	F _{a max} ²⁾ [kN]
250	144	M8	nr.6	60	99
280	162	M10	nr.6	60	157
320, 321	182	M10	nr.8	45	209
360	212	M12	nr.8	45	306

1) Thread depth 2·F.

2) Maximum total axial load relevant to bolts class 8.8.

(5) Stepped hollow low speed shaft (sizes 64 ... 360)

Gear reducers and gearmotors sizes 64 ... 360 can be also supplied with stepped hollow low speed shaft always with keyway; this design **facilitates** installation and removal and **affords a notable increase** in rigidity and resistance to bending and torsional stresses at the shaft end of the driven machine.

Hole with Ø D₂ is always **opposite to groove side**.

Important: the shoulder diameter of the driven machine shaft end abutting with the gear reducer must be at least $(1,18 \div 1,25) \cdot D$.

Supplementary description when ordering by **designation: stepped hollow low speed shaft.**



Shaft end of driven machine for fitting with key

Shaft end of driven machine for fitting with key and locking bushing

Gear reducer size	D Ø	D ₂ Ø	D ₃ Ø H7/h6	E 1)	E ₁ 1)	E ₂ 1)	E ₃	l	m	n	r
64	32	35	27	110	63	28	10	70	28	6	1,5
80	38	40	32	134	75	35	12	90	30	6	1,5
81	40	42	34	134	72	38	12	90	30	6	1,5
100	48	52	41	162	92	41	14	110	35	7	2
125	60	65	52	201	118	47	16	140	40	7	2
140	70	75	62	228	135	52	16	180	35	8	2
160	80	85	70	250	147	57	21	200	36	8	3
180	90	100	80	274	162	63	21	200	50	9	3
200	100	110	88	308	188	66	25	250	42	10	3
225	110	120	98	331	195	75	25	250	55	10	3,5
250	125	135	110	380	228	84	32	320	40	11	4
280	140	150	125	410	238	94	32	320	60	12	4
320, 321	160	170	140	471	276	107	43	400	45	13	5
360	180	195	160	506	293	116	43	400	72	14	5

● Position of the reference groove (see ch. 8, 10, 12, 14).

1) In presence of «Labyrinth seal and low speed shaft greaser» (ch. 17 (26)), it is necessary to increase the E (E₂) dimension by A quantity stated in the table on ch. 17 (26).

(6) Hollow low speed shaft with shrink disc (sizes 40 ... 360)

Sizes 40 ... 125

Gear reducers and gearmotors sizes 40 ... 125 can be supplied with hollow low speed shaft with shrink disc (see fig. a) – **always opposite side to groove** i.e. opposite side to motor for helical gearmotors – and not rotating protection cap on groove side (excluding input side of helical gear reducers and gearmotors sizes 40, 50 and MR 3I 63).

This design affords a notable increase in rigidity of keying and **reduces** the deformations of shaft end of driven machine (high mass **D**), also permits couplings with passing through shafts (only for bevel helical or long model see fig. c) eventually **avoiding**, when interposed between gear reducer and machine, the necessity of safety guards on the unit itself.

For the shaft end of driven machine on which gear reducer hollow low speed shaft (see fig. b) must be keyed, it is recommended to respect the dimensions stated in the table.

Important: the shoulder diameter of the driven machine shaft end abutting with the gear reducer must be at least $(1,18 \div 1,25) \cdot D$.

Supplementary description when ordering by **designation: hollow low speed shaft with shrink disc**

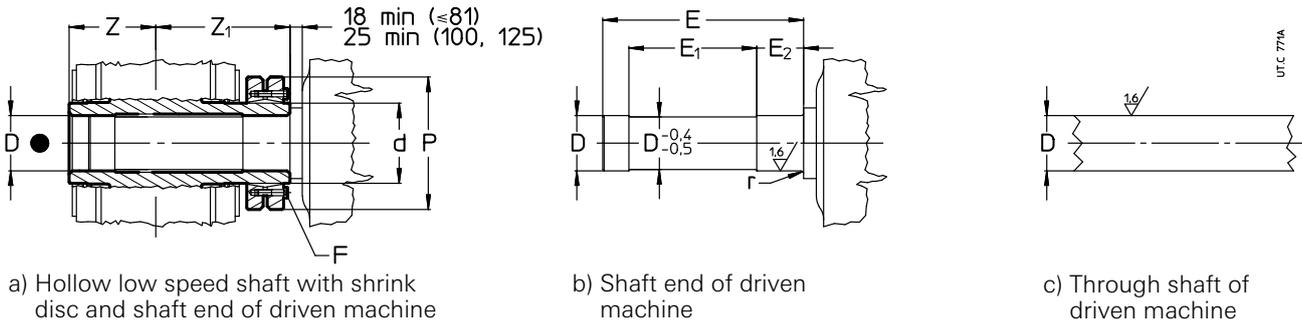

a) Hollow low speed shaft with shrink disc and shaft end of driven machine

b) Shaft end of driven machine

c) Through shaft of driven machine

Gear reducers size	D	E	E₁	E₂	F	M	d	P	r	Z	Z₁	M_{2SD}
	Ø H7/j6, h6 ¹⁾	4)	4)	4)								
40	20	99,5	65	25	M5 n.6	4	24	50	0,5	46	69	280
50	25	116,5	77	30	M5 n.7	4	30	60	0,5	53	79	400
63	30	135,5	86	34	M6 n.5	12	38	72	0,5	63	91	960
64	35	140	86	36	M6 n.7	12	44	80	1,5	63	93	1 400
80, 81	40	166	103	39,5	M6 n.8	12	50	90	1,5	75	107	1 800
100	50	197	122	46,5	M8 n.6	30	62	110	2,5	90	125	3 000
125	65	239	148	55	M8 n.8	30	80	145	2,5	110	148	5 200

1) Tolerance g6 also possible for shaft end opposite to shrink disc.

2) Tightening torque.

3) Maximum values for shrink disc.

4) In presence of «Labyrinth seal and low speed shaft grease» (ch. 17 (26)), in case of mounting of the shrink disc on machine opposite side, it is necessary to increase the E (E₂) dimension by A quantity stated in the table on ch. 17 (26).

● Position of the reference groove (see ch. 8,10, 12,14).

For design with labyrinth seals at low speed shaft, the dimensions E, E₁, E₂ are changing: please consult us.

Sizes 140 ... 360: side to machine

Gear reducers and gearmotors sizes 140 ... 360 can be supplied with **stepped** hollow low speed shaft with shrink disc **side to machine** – that is **opposite side to groove**, i.e. opposite side to motor for helical gearmotors – and not rotating protection cap on groove side.

This design **facilitates** installation and removal and **affords a notable increase** in rigidity of keying and **reduces** the deformations of machine shaft end, avoids possible problems of interference between shrink disc and motor flange (for helical gear units) and may **avoid** the use of safety guards on the unit itself. Moreover, since deformability of keying area is greater ($d - D_2 < d - D$) and friction area acts on a greater diameter $D_2 > D$, maximum transmissible torque increases by 18 ÷ 25% compared to the solution with shrink disc on opposite side to machine.

For a further axial fastening and in order to facilitate the assembling and disassembling operations (see ch. 18), it is possible to make use of hollow low speed shaft washer with retaining ring and bolt for axial fastening (on request).

For the shaft end of driven machine on which gear reducer stepped hollow low speed shaft must be keyed, it is possible to adopt both «long» and «short» shaft end of driven machine: dimensions as per table (for the other dimensions see ch. 18).

In the first case (fig. c), the assembly operations are facilitated, acting the «long» pivot as a guide. The possible application of a locking bushing with hollow low speed shaft washer (fig. d), reducing the fretting corrosion at the very least, especially facilitates the disassembling operations by giving at the same time a help in the torque transmission.

In the second case (fig. e), the reduced axial dimension of the «short» shaft end of driven machine, limits the mounting and removing overall dimensions at the very least.

17

17 - Accessories and non-standard designs

Gear reducer size	MR 2I ... UP2... max motor size (see ch. 12)	D ∅	D ₂ ∅	E 3)	E ₁	E ₂ 3)	F	M N m	n	d ∅	P ∅	r	Z	Z ₁	Y ₀	P ₀	M ₂ N m
		H7/j6, k6					UNI 5737-88 cl. 10.9	1)									2)
140	132, 160 B5R	70	75	294,5	192,5	52	M 8 n. 10	30	8	90	155	2	125	191,5	222	234	8 000
160	180	80	85	329	208	57	M 10 n. 9	60	8	105	185	3	136	215	234	234	12 000
180	180, 200 B5R	90	100	363	228	63	M 10 n. 12	60	9	120	215	3	150	239	256	234	18 000
200	225	100	110	402	260	66	M 12 n. 10	100	10	130	230	3	167	261	282	254	26 000
225	225, 250 B5R	110	120	428	277	75	M 12 n. 12	100	10	140	265	3,5	180	277	298	283	36 600
		H7/h6, j6															
250	280	125	135	493	318	84	M 16 n. 8	250	11	160	290	4	206	319	345	315	51 600
280	280, 315S B5R	140	150	543	337	94	M 16 n. 10	250	12	180	330	4	222	355	381	345	71 500
320, 321	315	160	170	607	388	107	M 16 n. 12	250	13	200	350	5	254	390	405	393	102 000
360	315	180	195	668	414	116	M 16 n. 15	250	14	230	370	5	273	435	466	394	143 000

1) Tightening torque.

2) Maximum values relevant to shrink disc.

3) In presence of «Labyrinth seal and low speed shaft grease» (ch. 17 (26)), it is necessary to increase the E dimension (E₂) by A quantity stated in the table on ch. 17 (26).

(7) Protection for hollow low speed shaft with shrink disc (sizes 140 ... 360)

Safety protections, made of steel, for gear reducers equipped with hollow low speed shaft with shrink disc on machine opposite side (groove side).

For dimensions and assembly sketch see «Low speed shaft with shrink disc on machine opposite side».

The accessory **cannot be supplied** for:

- **R I** gear reducers;
- gear reducers and gearmotors in vertical mounting positions **V5** and **V6 with shrink disc uppermost**;
- **some combined units of helical gearmotors (UP2...)** stated in the **table** (for the other gearmotor combined units this accessory will be available).

Supplementary description when ordering by **designation: protection for shrink disc.**

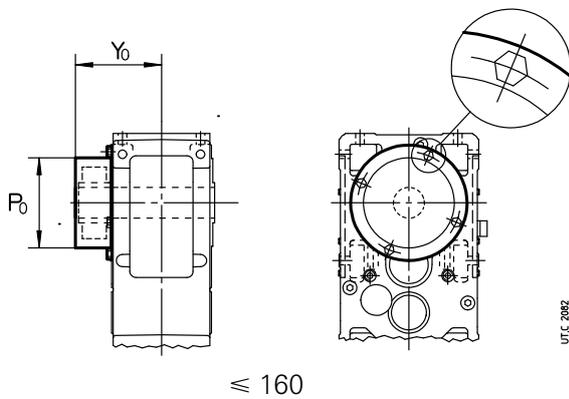

Gear reducer size	B5 motor size incompatible with accessory
MR 2I, 3I UP2...	
140	≥ 100
160	≥ 160
180	≥ 200
200	≥ 250
225	≥ 250
250	315
280	315

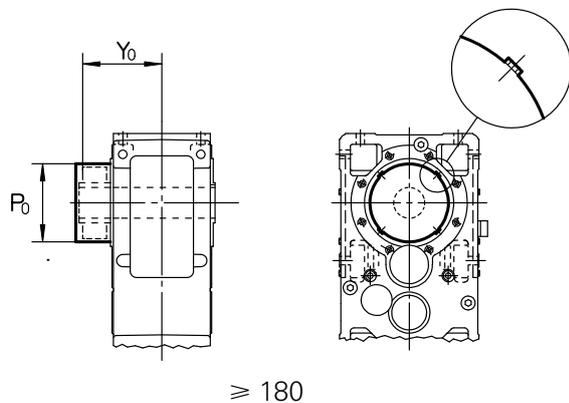

For dimensions **P₀** and **Y₀** see. ch. 17 (6).

17 - Accessories and non-standard designs

(8) Flange (sizes 40 ... 360)

All gear reducers and gearmotors can be supplied with B5 flange having clearance holes and spigot «recess».

For sizes 63 ... 81, it is available in two versions with different coupling dimensions: **B5 flange** and **B5 flange type B**.

The accessory is supplied fitted onto the gear reducer. Unless otherwise stated, the mounting position is on groove opposite side (input opposite, for helical gear units: for these sizes 40 ... 125 is the only one possible; for greater sizes, consult us). For groove side mounting position (for bevel helical gear units only), state in the designation: «**mounting on groove side**». Locking adhesives such as LOCTITE are recommended both around threads and on mating surfaces.

For dimensions H_1 and Z see ch. 8, 10, 12 and 14.

Supplementary description when ordering by **designation: flange B5** or **flange B5 type B** (see table).

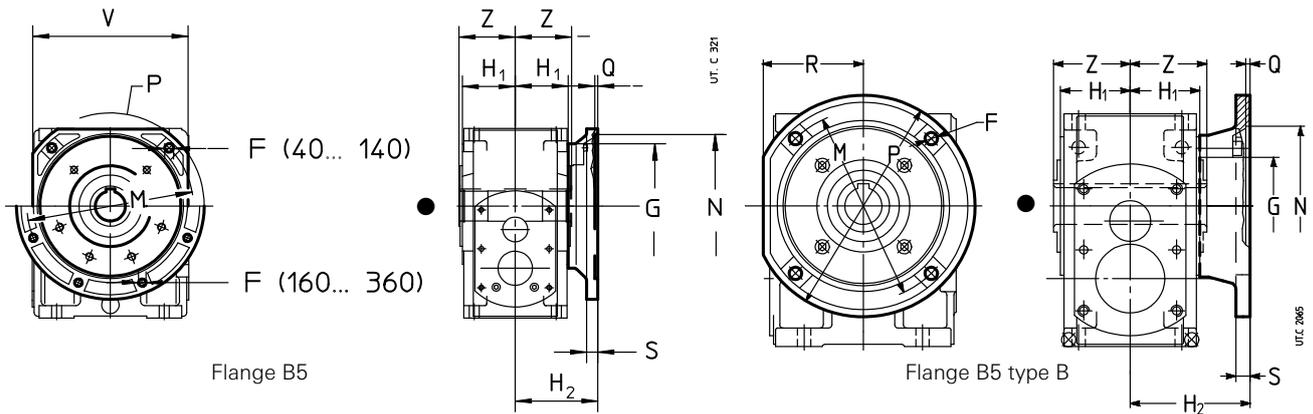

● Position of the reference groove (see ch. 16) for radial load verification.

Gear reducer size	F ∅	G ∅	H ₂ h12	M ∅	N ∅ H7	P ∅	Q	R	S	V □	Mass kg	Designation
40	9,5	60	80	115	95	140	4	–	11	110	0,8	Flange B5
50	9,5	70	80	130	110	160	4,5	–	12	122	1	Flange B5
63, 64	11,5	80	100	165	130	200	4,5	–	14	152	2	Flange B5
63, 64	14	80	107	176	152	210	6	100	14	–	2,9	Flange B5 type B
80, 81	14	110	112	215	180	250	5	–	16	196	3,2	Flange B5
80, 81	14	110	129	230	170	280	6	121	16	–	5,8	Flange B5 type B
100	14	130	132	265	230	300	5	–	18	248	5,5	Flange B5
125	18	180	154	300	250	350	6	–	20	290	8,5	Flange B5
140	18	230	165	350	300	400	6	–	22	350	13	Flange B5
160	18 ⁸	230	191	400	350	450	6	–	22	–	15	Flange B5
180	18 ⁸	250	191	400	350	450	6	–	22	–	20	Flange B5
200	18 ⁸	300	231	500	450	550	6	–	25	–	25	Flange B5
225	22 ⁸	350	231	500	450	550	6	–	25	–	31	Flange B5
250, 280	27 ⁸	450	280	600	550	660	7	–	30	–	50	Flange B5
320 ... 360	33 ⁸	550	345	740	680	800	7	–	37	–	80	Flange B5

17 - Accessories and non-standard designs

(9) Backstop device (sizes 50 ... 360)

For the sizes stated in the table, helical **gear reducers** with $i_N \geq 10$, bevel helical with $i_N \geq 12,5$ ($i_N \geq 10$ for size 50; $i_N \geq 11,2$ for sizes 160, 200, 250, 320, 321) and helical and bevel helical **gearmotors**, can be supplied together with backstop device; the designs and the positions are the ones stated below. For the value of dimensions **a, C, H, H₁, H₀** see ch. 8, 10, 12 and 14.

Supplementary description when ordering by **designation: backstop device, white or black arrow free-rotation**.

2I¹⁾ 63 ... 360

UP2A

3I 63 ... 125

UP2A

3I 140 ... 360²⁾

UP2A

Gear reducer size	2I, 3I, 4I	
	X Ø	Y
63, 64	47	7
80, 81	52	7
100	62	7
125, 140	72	10
160, 180	90	10
200, 225	110	10
250, 280	130	7
320 ... 360	170	7

1) Also MR 4I sizes 63 ... 125.

* Backstop device doesn't project from dimension H₁. Also available for UP2D, UP4A and UP4D design.

C1¹⁾ 50 ... 100

U03A U03Asin

ICI 50 ... 200

U03A U03Asin

C2I 140 ... 360

U02A U02V U02V sin

1) Also MR C3I sizes 50 ... 125.

U02A sin U02A
(140, 180, 225, 280, 360)

CI 125 ... 360

U02V U02V sin

Gear reducer size	CI, ICI, C3I		C2I	
	X Ø	Y	X Ø	Y
50 ... 64	47	4	—	—
80, 81	52	4	—	—
100	62	4	—	—
125, 140	122	16	72	10
160, 180	155	21	90	10
200, 225	190	21	110	10
250, 280	238	26	130	7
320 ... 360	— ²⁾	— ²⁾	170	7

2) Backstop device is fitted between high speed shaft bearings.

Backstop device load capacity

Nominal torque M_{N2} [N m] of backstop device when lower than M_{N2} of gear reducer (see ch. 9, 11, 13). Maximum permissible overload $1,7 \cdot M_{N2}$.

Gear reducer size	Train of gears (i_N) M_{N2} [N m]		
	3I (28) C2I (20)	2I (10) 3I (31,5) C2I (22,4)	3I (35,5) C2I (25)
140	2 800	3 150	3 550
180	5 600	6 300	7 100
225	11 200	12 500	14 000
280	21 200	23 600	26 500
321, 360	42 500	47 500	53 000

17 - Accessories and non-standard designs

(10) Reaction bolt using disc spring (sizes 40 ... 360)

Reaction arrangement for shaft mounting

See technical explanations at ch. 18.

For dimensions **A**, **A₁**, **B** see ch. 8, 10, 12 and 14.

For trains of gears CI, ICI, C3I apply this system **preferably** on side **1**; for trains of gears 2I, 3I, 4I **do not** apply on side **2**.

Supplementary description when ordering by **designation: reaction bolt using disc springs.**

2I ≤ 125 ; 3I ≤ 125 ; 4I

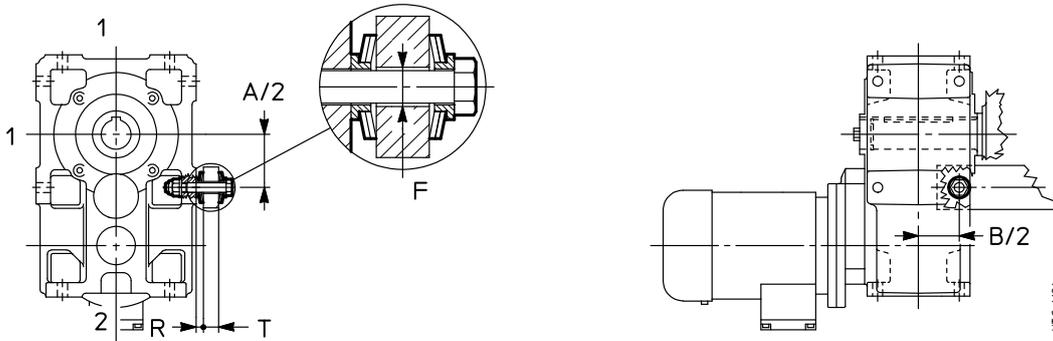

CI ≤ 100 ; ICI ≤ 125 ; C3I

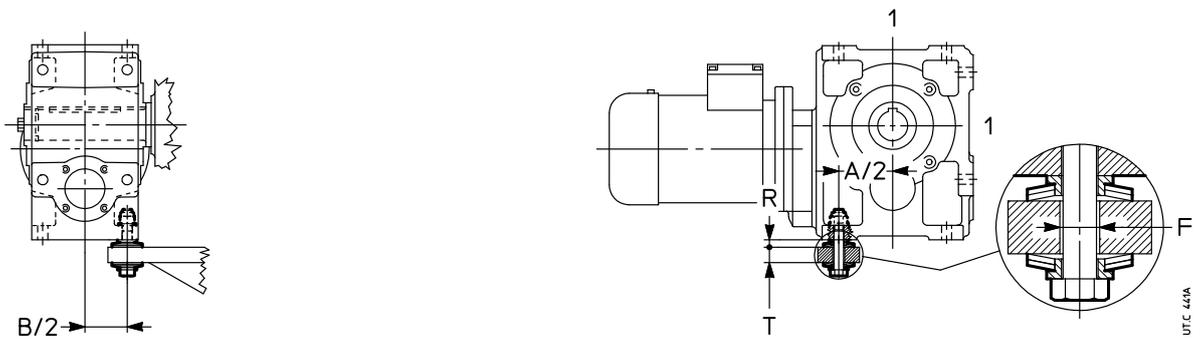

CI ≥ 125

2I ≥ 140 ; 3I ≥ 140 ; C2I

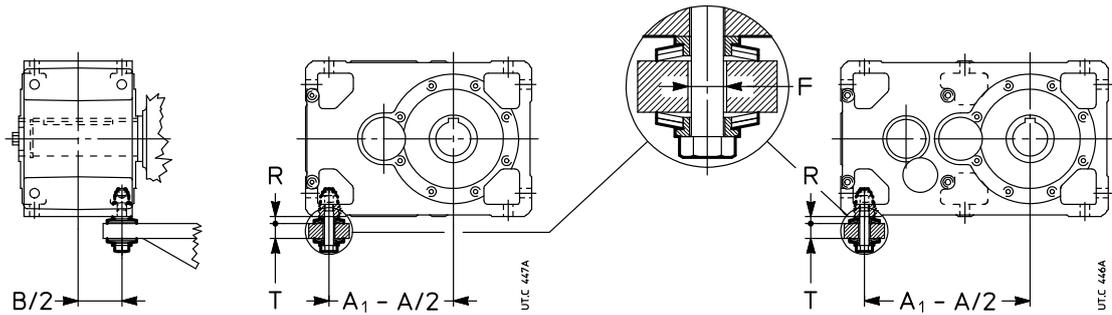

Gear reducer size	Screw	Disc spring		T	F ∅	R 1)	M ₂ ≤ 2) N m
	UNI 5737-88	DIN 2093					
40	M 6 × 40	A18	n.2	8 ÷ 10	8	4,9	63
50	M 8 × 55	A25	n.2	10 ÷ 14	11	6,5	140
63, 64	M 12 × 70*	A35,5	n.2	14 ÷ 17	20	8,8	224
80, 81	M 12 × 90	A35,5	n.3	18 ÷ 25	20	10,8	400
100	M 16 × 110	A50	n.2	25 ÷ 32	20	13,1	630
125, 140	M 16 × 110	A50	n.2	25 ÷ 32	20	13,1	1000 ³⁾
160, 180	M 20 × 130	A63	n.3	25 ÷ 38	24	17,9	—
200, 225	M 24 × 160	A80	n.2	29 ÷ 48	30	20,7	—
250, 280	M 30 × 200	A100	n.2	37 ÷ 60	36	26,2	—
320 ... 360	M 36 × 260	A100	n.3	45 ÷ 75	42	32,2	—

* Modified bolt.

1) Theoretical value: tolerance 0 ÷ -1.

2) For higher M₂ values, use 2 reaction bolts or the arrangement with bracket (see following page).

3) The limit 1 000 N m is applied only to size 125, for all train of gear excluding train of gear CI.

17 - Accessories and non-standard designs

(11) Kit using reaction disc springs (sizes 40 ... 125)

Reaction arrangement for shaft mounting

See technical explanations at ch. 18.

For dimensions **A**, **A₁**, **B** see ch. 8, 10, 12 and 14.

Supplementary description when ordering by **designation: kit using reaction disc springs.**

$2l \leq 125$; $3l \leq 125$; $4l$

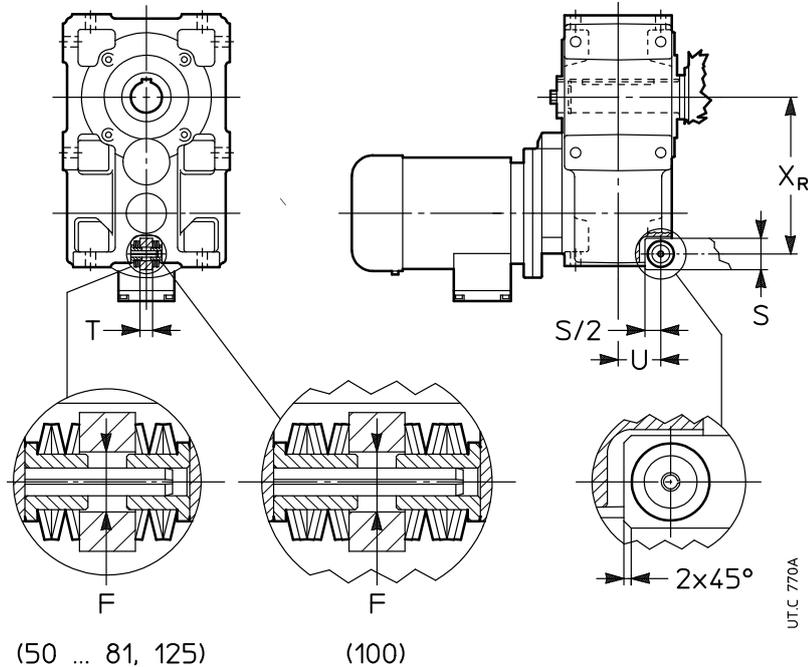

(50 ... 81, 125)

(100)

Gear reducer size	Disc spring DIN 2093	F	T h11	S	x_R	U	M₂ ≤ N m
40	A18 n.3	10	10	22	106	32,5	–
50	A25 n.3	13	12	30	130	37,5	–
63	A25 n.3	13	15	35	163	50	–
64	A25 n.3	13	15	35	165	50	350 ²⁾
80, 81	A35,5 n.3	19	20	40	199	54	–
100	A35,5 n.6	19	25	50 ¹⁾	246 ³⁾	66	–
125	A50 n.3	26	30	60	306 ³⁾	82	2 600 ²⁾

1) $S/2 = 22,5$ mm.

2) For mounting positions B3 and B8.

3) For long model x_R dimension is: 351 (size 100), 439 (size 125).

17 - Accessories and non-standard designs

(12) Reaction bolt using disc springs with bracket (sizes 63 ... 225)

Reaction arrangement for shaft mounting

See technical explanations at ch. 18

For dimensions **A**, **A₁**, **B** see ch. 8, 10, 12 and 14.

This arrangement can be applied, if need be (overall dimension, less stress or other reasons) on the **short** farthest side from low speed shaft also for parallel shaft gear reducers sizes 63 ... 225.

Supplementary description when ordering by **designation: reaction bolt using disc springs and bracket**.

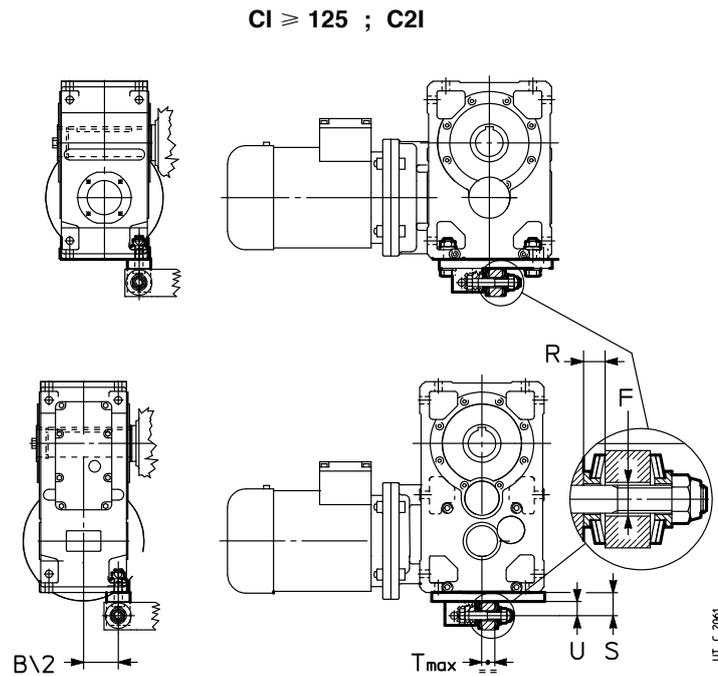
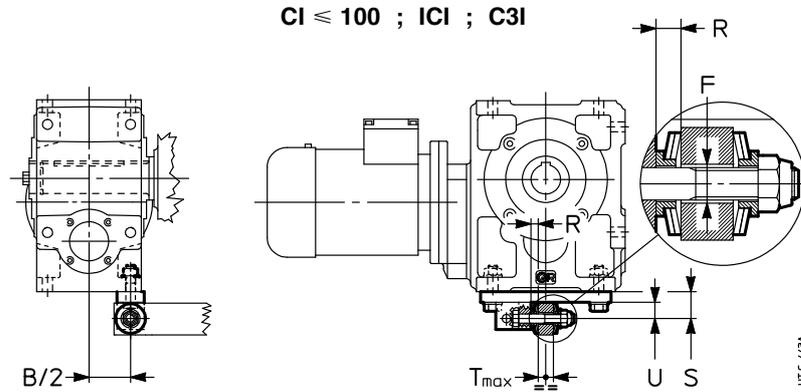

Gear red. size	Screw	Disc spring	T	F Ø	S	U	R 1)	B/2
	UNI 5737-88	DIN 2093						
63, 64	M 12 × 70*	A 35,5 n.1	14 ÷ 17	20	38	23	6,8	45
80, 81	M 12 × 90	A 35,5 n.2	18 ÷ 25	20	38	23	8,8	53
100	M 16 × 110	A 50 n.2	25 ÷ 32	20	50	30	13,1	65,5
125, 140	M 16 × 110	A 50 n.2	25 ÷ 32	20	50	30	13,1	81
160, 180	M 20 × 130	A 63 n.3	23 ÷ 38	24	65	40	17,9	100,5
200, 225	M 24 × 160	A 80 n.2	29 ÷ 48	30	80	48	20,7	125

* Modified bolt.

1) Theoretical value after tightening: tolerance 0 ÷ -1.

17 - Accessories and non-standard designs

(13) Rigid or flexible torque arm using bracket (sizes 63 ... 225)

Reaction arrangement for shaft mounting

See technical explanations at ch. 18.

For dimensions **A**, **A_r**, **B** see ch. 8, 10, 12 and 14.

This arrangement can be applied, if need be (overall dimension, less stress or other reasons) on the short farthest side from low speed shaft in all gear reducers sizes 63 ... 225.

Supplementary description when ordering by **designation: rigid** or **flexible torque arm using bracket**.

CI ≤ 100 ; ICI ; C3I

CI ≥ 125

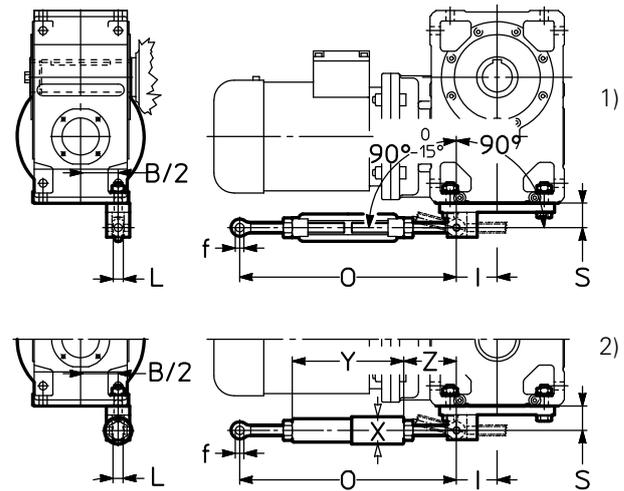
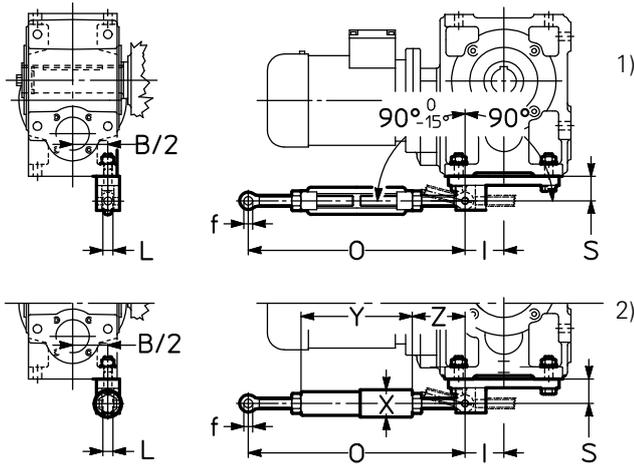

C2I

2I ≥ 140 ; 3I ≥ 140

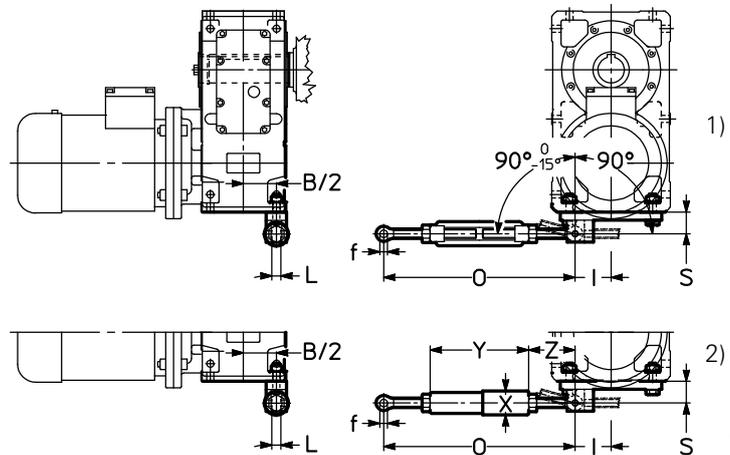
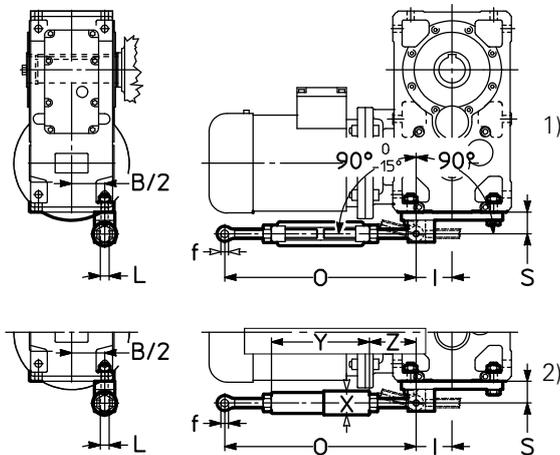

UT. C 2408

1) Rigid torque arm using bracket.

2) Flexible torque arm using bracket (not supplied for size 63 ... 81).

Gear red. size	f ∅	O	S	L	X ∅	Y	Z ≈	I	B/2
63, 64	12	280 ÷ 350	38	14	—	—	—	50	45
80, 81	12	280 ÷ 350	38	14	—	—	—	56	53
100	16	410 ÷ 510	50	17	52	242	84	74	65,5
125, 140	16	410 ÷ 510	50	17	52	242	84	74	81
160, 180	22	580 ÷ 680	65	24	64	285	147	92	100,5
200, 225	28	580 ÷ 680	80	30	88	305	137	113	125

17 - Accessories and non-standard designs

(14) Torque arm (sizes 40 ... 81)

Reaction arrangement for shaft mounting

See technical explanations at ch. 18.

For dimensions **A**, **A₁**, **B** see ch. 8, 10, 12 and 14.

The accessory, including fixing bolts for gear reducer, is supplied not assembled. According to motor overall dimensions, the assembly towards motor could not be possible.

Supplementary description when ordering by **designation: torque arm**.

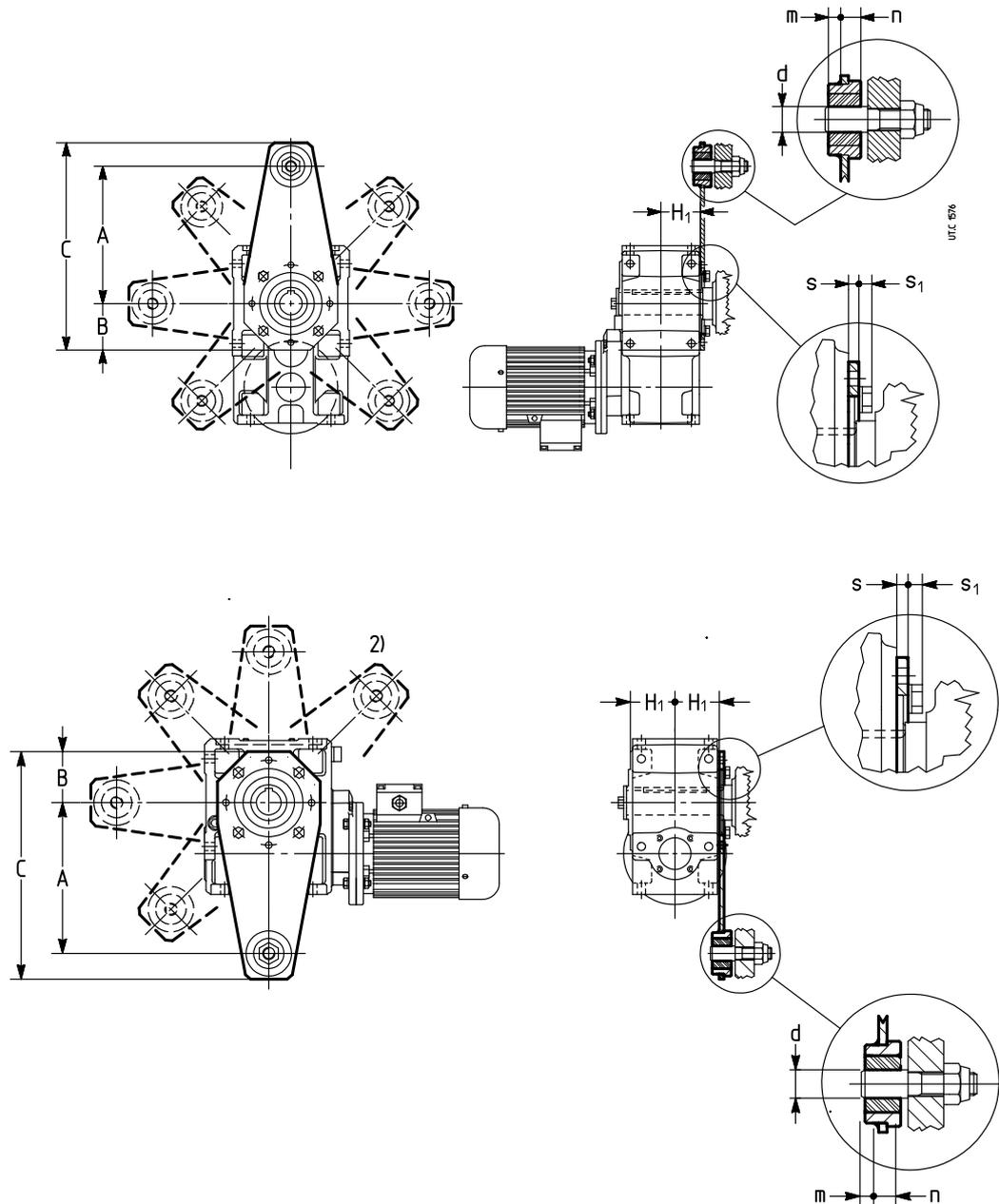

Gear reducer size	A	B	C	d Ø H11	H ₁ h12	m	n Ø	s	s ₁ ≈	M ₂ ≤ N m
40	100	45	157	8 ¹⁾	41,5	5	9	4	4,7	135
50	150	52,5	230	10	49	7	13	6	5,6	280
63, 64	200	60	294	20	58,5	9,5	15,5	6	7,5	335
80, 81	250	80	364	20	69,5	9,5	15,5	6	9,2	670

1) Plastic damping bushing not present.

2) Position not possible for train of gears MR ICI.

17 - Accessories and non-standard designs

(15) Fan cooling (sizes 125 ... 360)

The **helical** gear reducers of size and train of gears stated in the table can be supplied with **one** or **two** fans. For the value of dimensions **e**, **e₁**, and **c**, **c₁** see ch. 8

Gearmotors MR 2I 140 ... 360 and MR 3I 140 ... 360 **UP...D** can be supplied fitted with **one** fan.

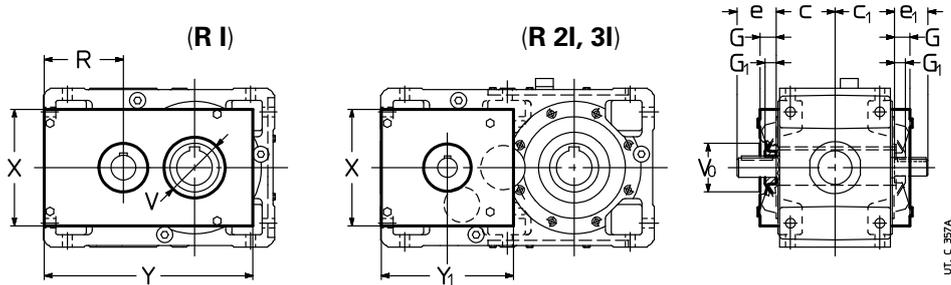

Gear reducer size		G	G ₁	R	V ₀ ∅	V ∅	X	Y	Y ₁
R I ⁴⁾	R 2I ⁴⁾ , R 3I ⁴⁾	1)				3)			
125	140	34	25 ⁵⁾	148	90	90	212	379	247
140	-	51	39	148	90	100	240	420	-
160	160, 180	38	25 ⁶⁾	178	110 ⁶⁾	115	264	469	297
180	-	54	39	178	110	130	296	487	-
200	200, 225	44	32	223	130	140	326	585	357
225	-	44	32	223	140	160	326	610	-
250	250, 280	52	40 ²⁾	278	160	175	426	740	447
280	-	52	40	278	175	200	426	770	-
320, 321	320 ... 360	63	50 ²⁾	353	200	220	554	951	557
360	-	63	50	353	220	260	554	991	-

- 1) Bolts projecting 6 mm from dimension **G**.
- 2) For R 3I dimension G₁ = 32 (250, 280), 40 (320 ... 360).
- 3) Only for **second** fan in pos. **2** or, on request, in other cases.
- 4) Design not possible with B5 flange on fan side; if required, consult us.
- 5) For R 2I 140 pos. **2** dimension G₁= 15.
- 6) For R 3I 160 and 180 with *i* ≥ 72 and/or pos. **2** dimension G₁=15 and dimension V₀=90.

For **R I** gear reducers, the forced cooling with fan is in some cases incompatible with other non-standard designs and accessories, according to the scheme on the following table; consult us, if need be.

Non-standard design	UP...A, UP...L One fan in pos. 1		One fan in pos. 2		UP...D One fan in pos. 1		Two fans	
	Groove side •	Groove opposite side	Groove side •	Groove opposite side	Groove side •	Groove opposite side	Groove side •	Groove opposite side
(1) Standard low speed shaft ¹⁾	-	✓	✓	-	-	✓	-	✓
(2) Solid low speed shaft ¹⁾	-	✓	✓	-	-	✓	-	✓
(6) Hollow low speed shaft with shrink disc	-	✓	✓	-	-	✓	-	-
(8) Flange	-	✓	-	-	-	-	-	-

- Design or accessory not possible.
- ✓ Design or accessory possible.
- 1) **Double extension** low speed shaft not possible.

Bevel helical gear reducers of size and train of gears indicated in the table can be supplied fitted with **one** fan. See ch. 10 for dimensions **e** and **c**.

Also gearmotors MR CI 125 ... 280, MR C2I 160 ... 360 ... **D** ..., ... **H** ..., ... **R** ... can be supplied fitted with **one** fan.

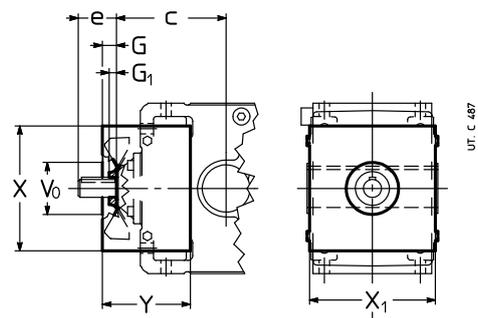

17 - Accessories and non-standard designs

Gear reducer size CI			G	G₁	V₀ ∅	X	X₁ 1)	Y
125	R	$i_N \leq 8$	25	15	90	212	212	140
		$i_N \geq 9$	25	15	90	212	212	127
MR			25	15	90	212	212	127
140	R	$i_N \leq 9$	25	15	90	212	212	140
		$i_N \geq 10$	25	15	90	212	212	127
MR			25	15	90	212	212	127
160	R	$i_N \leq 8$	34	20	110	264	264	209
		$i_N \geq 9$	29	15	110	264	264	184
MR			29	15	110	264	264	184
180	R	$i_N \leq 9$	34	20	110	264	264	209
		$i_N \geq 10$	29	15	110	264	264	184
MR			29	15	110	264	264	184
200	R	$9 \leq i_N \leq 8$	41	20	150	326	326	255
		$i_N \leq 16$	41	20	130	326	326	232
		$i_N \geq 18$	41	15	130	326	326	232
MR			41	20	130	326	326	232
			41	15	130	326	326	232
225	R	$10 \leq i_N \leq 9$	41	20	150	326	326	255
		$i_N \leq 16$	41	20	130	326	326	232
		$i_N \geq 18$	41	15	130	326	326	232
MR			41	20	130	326	326	232
			41	15	130	326	326	232
250	R	$11,2 \leq i_N \leq 10$	47	25	175	426	404	317
		$i_N \leq 16$	46	25	150	426	404	293
		$i_N \geq 18$	46	20	150	426	404	293
MR			46	25	150	426	404	293
			46	20	150	426	404	293
280	R	$12,5 \leq i_N \leq 11,2$	47	25	175	426	404	317
		$i_N \leq 16$	46	25	150	426	404	293
		$i_N \geq 18$	46	20	150	426	404	293
MR			46	25	150	426	404	293
			46	20	150	426	404	293
320 ... 360 R			57	32	220	554	500	392

1) Bolts projecting 6 mm from dimension **X₁**.

Grand.riduttore C2I			G	G₁	V₀ ∅	X	X₁ 1)	Y
160	R	$i_N \leq 31,5$	25	15	110	264	264	184
		$i_N \geq 35,5$	25	15	110	264	264	173
MR			25	15	110	264	264	173
180	R	$i_N \leq 31,5$	25	15	110	264	264	184
		$i_N \geq 35,5$	25	15	110	264	264	173
MR			25	15	110	264	264	173
200	R	$i_N \leq 31,5$	34	20	130	326	326	232
		$i_N \geq 35,5$	41	15	130	326	326	222
MR			41	15	130	326	326	222
225	R	$i_N \leq 31,5$	34	20	130	326	326	232
		$i_N \geq 35,5$	41	15	130	326	326	222
MR			41	15	130	326	326	222
250	R	$35,5 \leq i_N \leq 31,5$	43	20	150	426	404	293
		$i_N \leq 63$	41	20	150	426	404	268
		$i_N \geq 71$	41	15	150	426	404	268
MR			41	20	150	426	404	268
			41	15	150	426	404	268
280	R	$35,5 \leq i_N \leq 31,5$	43	20	150	426	404	293
		$i_N \leq 63$	41	20	150	426	404	268
		$i_N \geq 71$	41	15	150	426	404	268
MR			41	20	150	426	404	268
			41	15	150	426	404	268
320 321 360	R	$35,5 \leq i_N \leq 31,5$	55	32	220	554	500	365
		$i_N \leq 63$	46	25	185	554	500	333
		$i_N \geq 71$	46	20	185	554	500	333
MR			55	32	220	554	500	365
			46	25	185	554	500	333
			46	20	185	554	500	333

1) Bolts projecting 6 mm from dimension **X₁**.

With double extension high speed shaft designs both extensions are **accessible** even with fan fitted: personnel safety-guards are the Buyer's responsibility (2006/42/EC).

Designs and positions are as shown below.

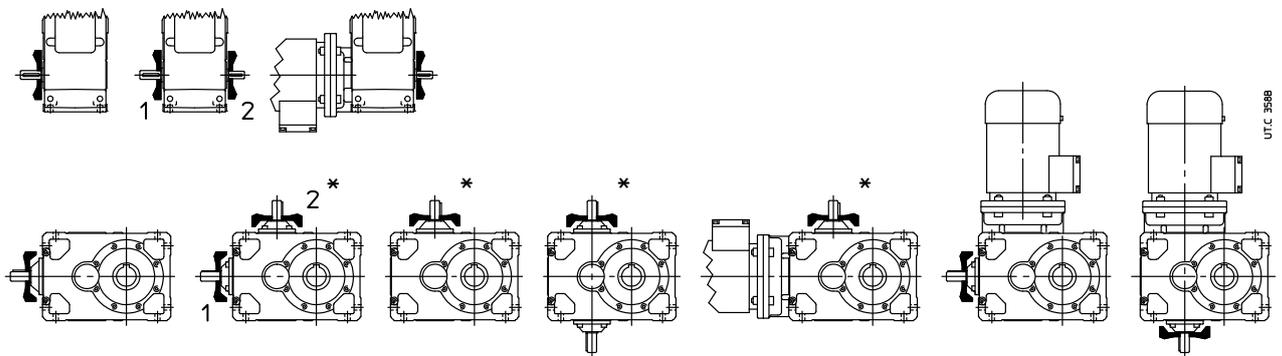

* Fan position is not possible for train of gears C2I.
** Not possible for MR CI sizes 140, 180, 225, 280.

Temperature of cooling air must not exceed ambient temperature.

Supplementary description when ordering by **designation: fan cooling**; in design with double extension high speed shaft state if pos. **1** or **2** or – only for helical gear units – **1** and **2**.

Also available independent cooling unit with heat exchanger (see h. 17 (30)); consult us, if need be.

17 - Accessories and non-standard designs

(16) Water cooling by coil (sizes 125 ... 360)

Gear reducers and gearmotors sizes 125 ... 360, excluding ICI train of gears and mounting positions V... with groove side towards the bottom, can be supplied with copper alloy coil for water cooling.

On request, available also stainless steel coil (AISI 316) or cupro-nickel; consult us.

Cooling water specifications:

- be not too hard;
- max temperature 20 °C;
- capacity $10 \div 20 \text{ dm}^3/\text{min}$;
- pressure $0,2 \div 0,4 \text{ MPa}$ ($2 \div 4 \text{ bar}$).

A smooth metallic pipe (with external diameter **d** stated on table) is sufficient for the connection.

The load loss in the coil, according to the water flow and pressure, is of $0,6 \div 0,8 \text{ bar}$ for diameter $\varnothing d16$ and $0,8 \div 1 \text{ bar}$ for diameter $\varnothing d 12$.

On request **thermostatic valve** which, automatically and without auxiliary supply need, permits water circulation when gear reducer oil reaches the set temperature; the valve sensor is equipped with immersion bulb. Mounting and setting, adjustable within $50 \div 90 \text{ }^\circ\text{C}$, are Buyer's responsibility.

For ambient temperature lower than $0 \text{ }^\circ\text{C}$ consult us.

Supplementary description when ordering by **designation: water cooling by coil** or **water cooling by coil and thermostatic valve**.

Gear reducer size	A ¹⁾ ≈	B ¹⁾ ≈	d Ø	Ms N m
125 ... 180	40	40	12	35
200 ... 280	50	40	12	30
320 ... 360	60	45	16	35

1) Values valid for B3 mounting position and U ... A design. For other mounting positions and/or designs: consult us.

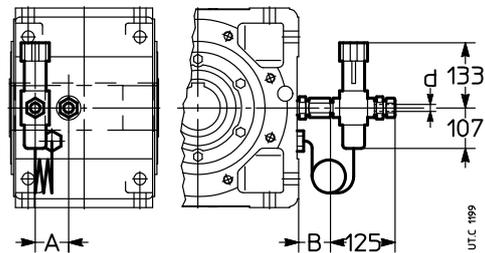

(17) Cooling by internal exchanger (sizes 140 ... 360)

The following gear reducers and gearmotors:

- sizes 140 ... 360;
- mounting positions B3, B6, B7, B8;
- helical gear units 2I, 3I;
- bevel helical C2I, design UO2A, ...H, ...V, ...R (excluding the relevant versions sin);

can be equipped with **internal** and **extractable** heat exchanger, made of aluminium, finned, mounted on gear reducer inspection cover (facilitating the maintenance operations) for the water cooling of lubrication oil.

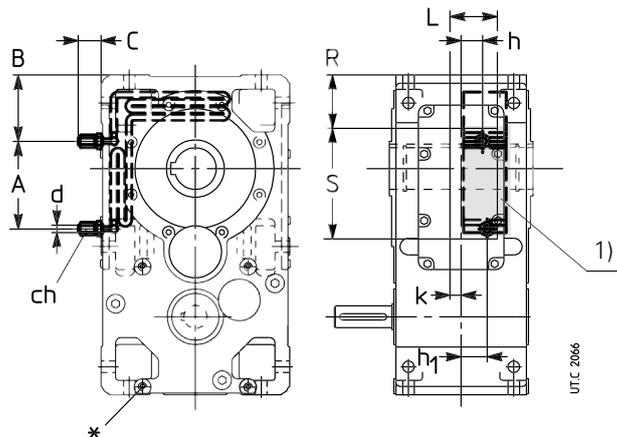

Internal heat exchanger, on gear reducer inspection cover

1) Free area for pipe fastening and coil fastening devices.

17 - Accessories and non-standard designs

The value of thermal factor ft_{1b} according to size and mounting position is given in the table.

Gear reducer size	ft_{1b}			A	B	C	ch	d	h	h_1	K	L	R	S
	B3	B6, B7	B8	≈	≈			∅						
140	1,7	1,9	1,8	30	81,5	54	22	12	32	19	16	68	60	130
160	2,12	2,36	2,24	0	102	54	22	12	20	46	16	86	77	177
180	2	2,24	2,12	0	102	54	22	12	21	47	15	86	77	177
200	2,24	2,5	2,36	190	152	25	22	12	41	41	14	75	105	263
225	2,12	2,36	2,12	190	152	25	22	12	41	41	14	75	105	263
250	2,36	2,65	2,5	180,5	170,5	25	22	12	50,5	50,5	18	100	125	311
280	2,24	2,5	2,36	180,5	170,5	25	22	12	54	54	15	100	125	311
320, 321	2,12	2,36	2,24	60	255	34	30	16	66	66	2	129	177	302
360	2	2,24	2,12	60	255	34	30	16	66	66	2	129	177	302

Cooling water specifications:

- be not too hard;
- max temperature max 20 °C;
- capacity 10 ÷ 20 dm³/min;
- pressure 0,2 ÷ 0,4 MPa (2 ÷ 4 bar).

A smooth metallic pipe (with external diameter **d** stated on table) is sufficient for the connection, paying attention to keep fixed the fillet using a second hexagon wrench, when fastening the pipe on the fillet.

The load loss in the internal exchanger, according to the water flow and pressure, is of 1,4 ÷ 1,8 bar for diameter ∅d 16 and 1,8 ÷ 2 bar for ∅d 12.

On request **thermostatic valve** which, automatically and without auxiliary supply need, permits water circulation when gear reducer oil reaches the set temperature (after technical feasibility verification, consult us); the valve sensor is equipped with immersion bulb. Mounting and setting, adjustable within 50 ÷ 90 °C, are Buyer's responsibility.

For ambient temperature lower than 0 °C consult us.

Supplementary description when ordering by **designation: independent cooling with internal exchanger.**

(18) Additional oversized housing hole for oil pipe cooling (sizes 160 ... 360)

In the event of oil cooling system through centralized external circuit (e.g.: paper plants) it is necessary to foresee an additional hole of proper dimensions on gear reducer housing in order to allow the lubricant flow for gravity.

The setting of oil flow at gear reducer input must be executed by the Customer during the installation.

The heat quantity dissipated by the system depends on oil flow and on input and output oil temperature difference.

Available only for mounting positions B3 and B8 and sizes 160 ... 360.

Threaded hole **G 2"** for sizes 160 ... 225 and **G 2 1/2"** for sizes 250 ... 360.

Supplementary description when ordering by **designation: additional oversized housing hole.**

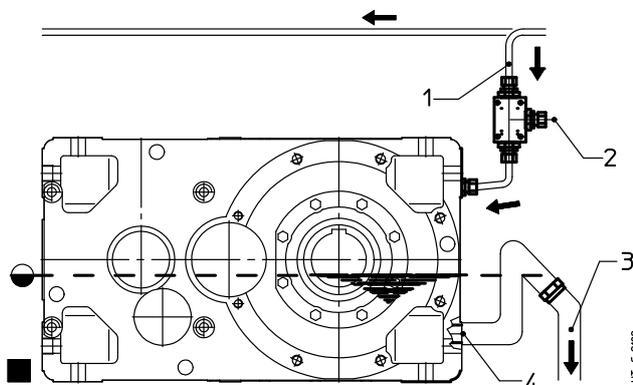

Legend:

- 1 Oil input.
- 2 Flow rate fine tuning value
- 3 Oil drain, towards centralized cooling tank
- 4 Additional oversized diameter housing hole

17 - Accessories and non-standard designs

(19) Bearing lubrication pump (sizes 100 ... 360)

Piston pump (driven by a cam from the low speed shaft) or **high speed shaft lubrication device** (only R 2I size 100 ... 280 and mounting position V5), for non oil-bath bearing lubrication.

In the following table the cases are stated where for mounting positions V5 and V6 and input speed included in the range $n_1 = 1\,400 \div 1\,800 \text{ min}^{-1}$ it is necessary to foresee the bearing lubrication pump or the high speed shaft lubrication device (see also \emptyset at ch. 8, 10, 12, 14). For other speed values, consult us.

The other cases where according to mounting position, it could be necessary to foresee a bearing lubrication pump, are marked with symbol \emptyset at ch. 8, 10, 12, 14; consult us.

In general, when the maximum system reliability is required, in presence of particularly heavy duty cycles or severe ambient conditions, it is necessary to evaluate the possibility to install a bearing lubrication pump; consult us.

Supplementary description when ordering by **designation: bearings lubrication pump or high speed shaft lubrication device**.

Train of gears	Mounting position	Presence of lubrication pump or lubrication device $n_1 = 1\,400 \div 1\,800 \text{ min}^{-1}$, (mounting positions V5, V6)				
		Gear reducer size				
		100, 125	140 ... 180	200, 225	250, 280	320 ... 360
R I	V5, V6	1)	1)	1)	1)	1)
R 2I	V5	D ²⁾	D ²⁾	D ²⁾	P	P
	V6	–	–	–	–	P
R 3I	V5	–	P	P	P	P
R CI	V5, V6	–	–	P	P	P
R C2I	V5, V6	–	–	–	–	P

– = Bearing lubrication pump and high speed shaft lubrication device not necessary.

D = Lubrication device.

P = Lubrication pump.

1) Consult us.

2) Lubrication pump on request.

(20) Hollow low speed shaft washer (sizes 40 ... 360)

All gear reducers and gearmotors can be supplied with washer, retaining ring (excluding sizes 40 ... 63), bolt for axial fastening and protection cap (excluding input side of helical gear reducers and gearmotors sizes 40, 50 and gearmotors 3I 63), see ch. 18.

Supplementary description when ordering by **designation: hollow low speed shaft washer**.

(21) Hollow low speed shaft washer with locking rings or bushing (sizes 40 ... 360)

All gear reducers and gearmotors (excluding MR 3I 40 ... 63) can be supplied with washer, retaining ring (excluding sizes 40 ... 63), locking rings (sizes 40 ... 63) or locking bushing (sizes 64 ... 360), bolt for axial fastening and protection cap (excluding input side of helical gear reducers and gearmotors, sizes 40, 50), see ch. 18 «Hollow low speed shaft».

ATTENTION. In applications with **travelling lifts**, the locking bushing is not sufficient to assure a stable keying of hollow low speed shaft with machine shaft end, even if the axial fastening screw is fitted with locking adhesive. In these cases, it is necessary to have a keying with hollow shaft and **shrink disc**. This is valid, in general, also for a high frequency of starting and braking with motion reversal and when the inertia ratio J/J_0 is very high (≥ 5).

Supplementary description when ordering by **designation: hollow low speed shaft washer with locking rings or bushing**.

17

(22) Hollow low speed shaft protection cap (sizes 40 ... 360)

The gear reducers and gearmotors, sizes 40 ... 360, can be supplied with a protection cap of the hollow low speed shaft free area (see ch. 18 «Hollow low speed shaft»).

ATTENTION. The protection cannot be mounted:

- on input side of helical gear reducers and gearmotors sizes 40, 50 and gearmotors 3I 63;
- in presence of standard low speed shaft;
- on sizes 180 ... 360 not equipped with the necessary pre-arrangement (e.g.: assembly is not possible for «aftermarket» supplies).

The protection cannot be supplied in presence of:

- double seal on low speed shaft (sizes 64 ... 160);
- labyrinth seal and greaser;

Consult us, if need be.

Supplementary description when ordering by **designation: hollow low speed shaft with protection cap or cover**.

17 - Accessories and non-standard designs

(23) Design for agitators, aerators, fans (sizes 125 ... 360)

This design has been specifically developed for aerators, agitators, and fans with high bending moment values (as a rough guide $\geq 0,4 \cdot M_2$).

In addition to the rigid and precise **single piece** housing, «symmetrical» **universal** mounting, **patented** keying system for motor sizes 200 ... 315 which offers easier assembly and disassembly and avoids fretting corrosion, taper roller bearings, the fundamental characteristics of this **compact, economic and reliable** design are:

- extended bearing housing to improve radial and axial load ratings (taper roller bearings) and to reduce overhangs;
- plentiful low speed shaft end diameter;
- double seals on the low speed shaft with chromium plated raceway;
- space between double seals packed with grease and top hat arrangement which acts as water splash guard for aerators and as slinger for fans;

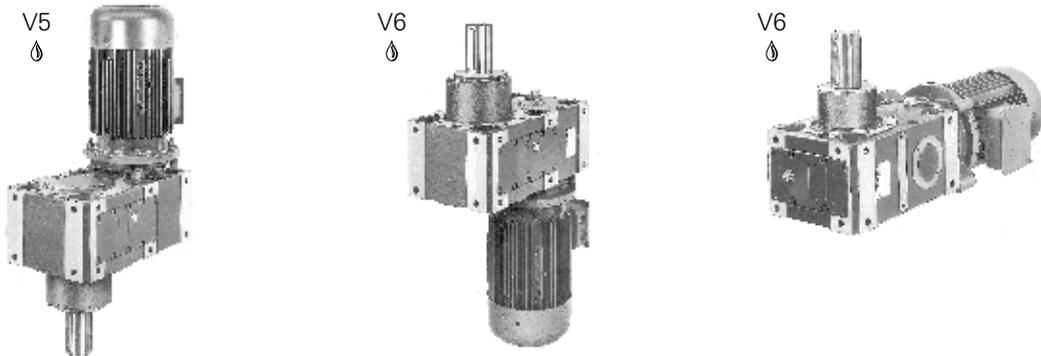

⊕) Bearing lubrication pump; for mounting position V5, consult us.

- oil lubricated bearing on low speed shaft end side: oil-bath for lower position (V5), pump lubrication for upper position (V6) (price addition); additional stainless steel drain plug to facilitate complete **oil** drainage. All this ensures **total reliability** (gear pairs and bearings) during running and **minimum maintenance**;

Options:

- drip proof cover for motor (standard protection IP 55);
- special paint;
- remote oil level and/or oil temperature indicator with threshold signal (sizes ≥ 160).

Combinations **2** (direction of rotation – axial load direction) are to be preferred since they permit to withstand the highest of the two F_{a2} axial loads (see following table).

ICI and C3I trains of gears not possible; for CI and C2I, the ...sin designs are not possible.

Supplementary description when ordering by **designation: design for agitators**.

IMPORTANT. For selection of the gear reducer or gearmotor size and verification of radial and axial loads (and hence for the need of this design) **we always must be consulted: a detailed program of calculation** enables us to give a quick and reliable answer.

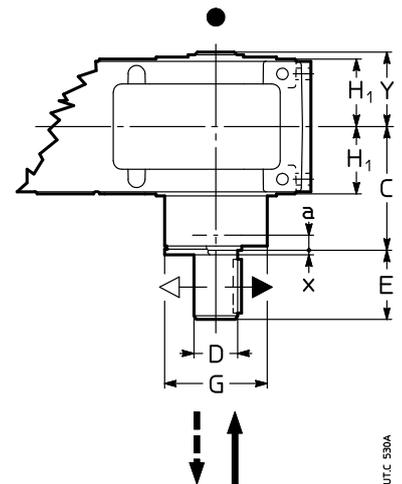

- Position of the reference groove (see ch.8, 10, 12, 14): useful for gear reducer design and mounting position identification on catalog.

Gear reducer size	a	C	D ∅ m6	E	G ∅	x ≈	Y	Δm kg	Axial load F_{a2}			
									↓	↑	↓	↑
125	55	220	70	105	140	3	108	12	1	2	2	1
140	62	235	70	105	159	3	122	20	1	2	2	1
160	68	270	90	130	183	4	133	28	2	1	1	2
180	72	275	90	130	226	4	148	38	2	1	1	2
200	76	327	110	165	248	4	164	55	1	2	2	1
225	76	340	110	165	248	4	177	65	1	2	2	1
250	97	402	140	200	310	5	203	105	2	1	1	2
280	97	418	140	200	310	5	218	120	2	1	1	2
320, 321	110	505	180	240	388	6	250	215	1	2	2	1
360	110	523	180	240	388	6	268	250	1	2	2	1

For dimension H_1 see ch. 8, 10, 12 and 14. Other dimensions at ch. 6 «High and low speed shaft end».

1) Position of the center point of the bearing.

2) Thickness of protection disk.

17 - Accessories and non-standard designs

(24) Optional paint (sizes 40 ... 360)

The gear reducers and gearmotors can be supplied with optional painting cycles (blue RAL 5010), according to following table and to corrosivity class of operating environment. Other protections or color on request: consult us.

Additional description when ordering by **designation: optional paint ...** (see code stated in the table; i.e.: «**optional paint 2HRAL5010**»).

Application field	Features	Corrosivity class	Durability classes	Description	Final thickness on machined parts µm	Code
Applications in aggressive environments	Good resistance to atmospheric and aggressive agents	C4	High	Dual-compound epoxy primer + water based dual-compound polyurethane paint	≥ 120	1HRAL5010 (blue)
				Dual-compound epoxy primer (x 2) + water based dual-compound polyurethane paint	≥ 180	2HRAL5010 (blue)
				Dual-compound epoxy primer (x 4) + water based dual-compound polyurethane paint	≥ 300	3HRAL5010 (blue)
Outdoor applications in saline environment MARINE CYCLE	Excellent resistance to atmospheric and aggressive agents Outdoor applications in saline environment (MARINE CYCLE)	C 5 - M	Average	Sanding + Dual compound Antirust primer with zinc phosphates + Dual-compound epoxy primer (x 3) + Water based Dual-compound polyurethane paint	≥ 300	2IRAL5010 (blue)
Outdoor applications in chemically aggressive environment and high humidity industrial areas	Excellent resistance to atmospheric and aggressive agents Outdoor applications in chemically aggressive environment (fertilizers, etc.)	C 5 - I	Average	Sanding + Antirust primer with zinc phosphates + Dual-compound epoxy primer (x 3) + Water based Dual-compound epoxy paint	≥ 300	2LRAL5010 (blue)

17 - Accessories and non-standard designs

(25) Heater (sizes 125 ... 360)

Oil heater for starting at low ambient temperature.

Specify the design «Oil temperature probe» together with this design.

The heater is piloted through proper control device (at customer's care e.g.: PLC or supplied by Rossi e.g. 2-threshold signalling device CT03 or three-threshold signalling device CT10) releasing when achieving the pre-set oil temperature.

IMPORTANT. The data stated in the table refer to **mounting positions B3 and B8 only**; for other mounting positions, consult us.

The design can be not compatible with other designs (e.g. internal pump...), consult us.

Not possible for train of gears ICI and C3I.

Features:

- specific power 2W/cm²;
- single phase supply 230 V 50-60 Hz or three-phase supply Δ 230 Y 400 V 50-60 Hz (see table);
- stainless steel resistors AISI 321;
- metallic terminal box; cable gland protection IP 65;
- horizontal mounting with oil bath lubrication;
- max oil temperature 90 °C;
- threaded brass joint;
- available also in explosion-proof design ATEX II 2G EExd IIC T4: consult us.

Supplementary description when ordering by **designation: oil heater**.

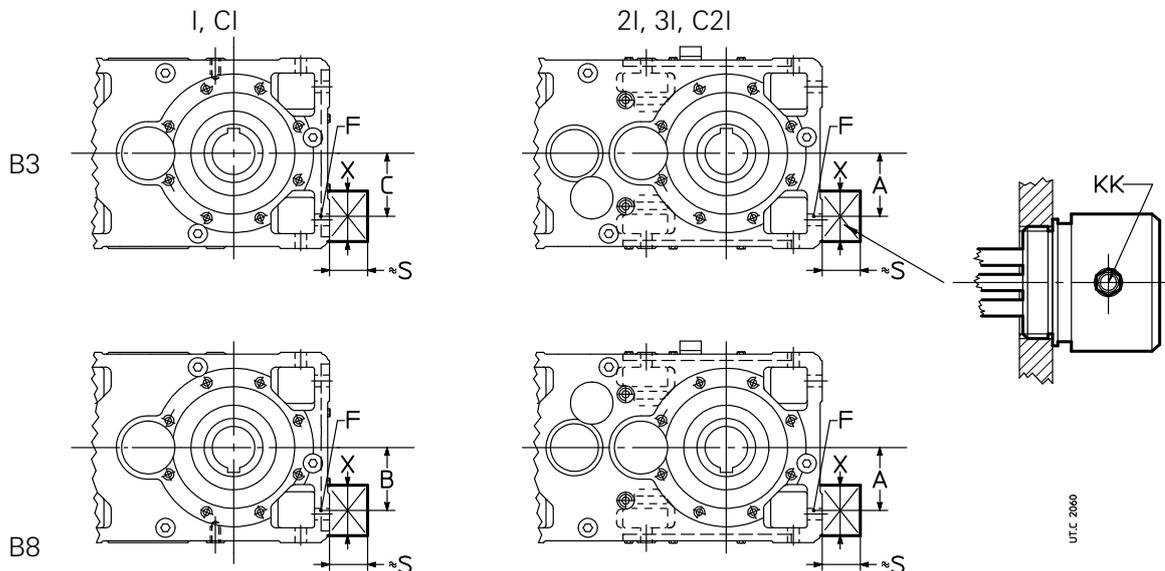

Gear reducer size	A	B	C	F	S ≈	X ≈	P W	KK	Supply
125	85	85	85	G 1"	85	85	300	Pg 11	1~ 230 V 50-60 Hz
140	100	85	100	G 1" 1/4			600	Pg 13	
160	125	114	114				G 1" 1/2		900
180	150	100	125	G 2"	90	1500		2100	3~ Δ 230 Y 400 V 50-60 Hz
200		146	146						
225	140	155							
250	200	170	170						
280	170	235							
320, 321	250	235	235						
360		222	318						

Wiring schemes:

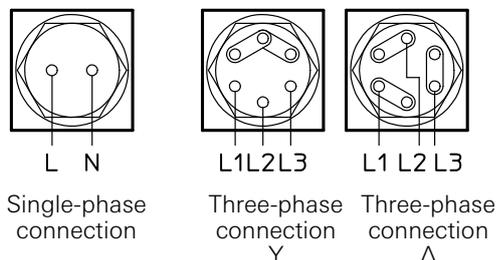

17 - Accessories and non-standard designs

(26) Seals on high and low speed shafts (sizes 125 ... 360)

The seal types available (standard and on request) for sizes 125 ... 360 on low and high speed shaft, are stated in the following table; for size ≤ 100 , consult us.

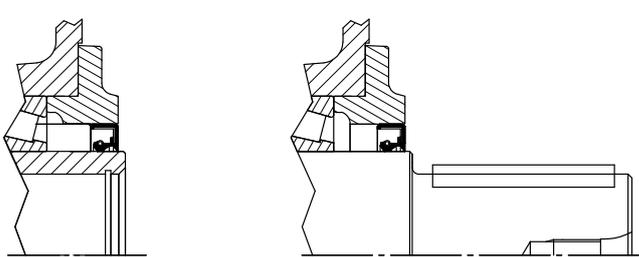
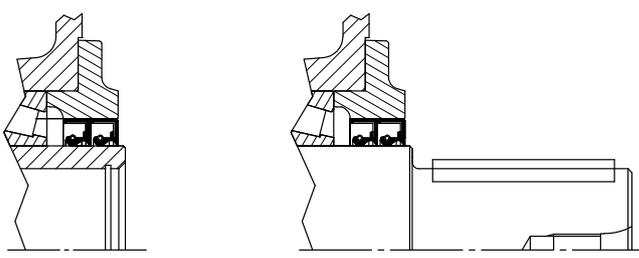
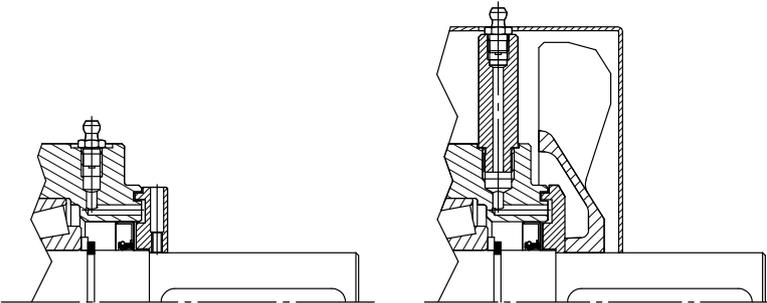
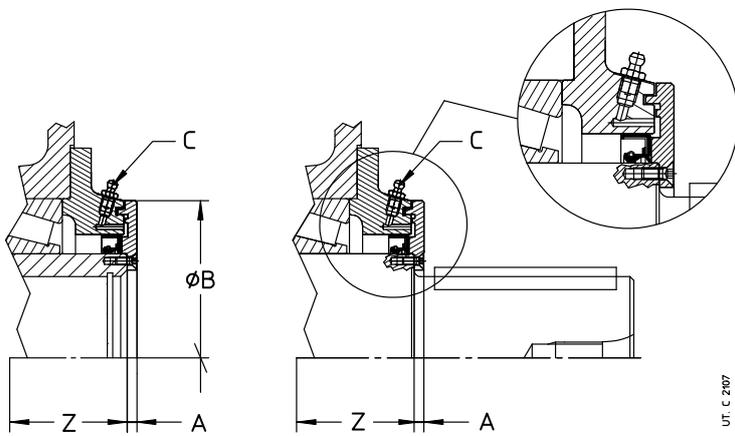
Type of seal	Scheme
Standard	
High speed shaft double seal Environment is quite dirty and/or outdoor	 Additional description when ordering by designation : high speed shaft double seal. low speed shaft double seal.
Low speed shaft double seal Environment is quite dirty and/or outdoor	
Labyrinth seal and high speed shaft greaser («taconite») Environment is very dirty (e.g.: mining industry)	 Additional description when ordering by designation : labyrinth seal and high speed shaft greaser.
Labyrinth seal with low speed shaft greaser («taconite») Environment is very dirty (e.g.: mining industry) 1)	 Note: for Z dimension see ch. 8, 10, 12 and 14. Additional description when ordering by designation : labyrinth seal and low speed shaft greaser.

Gear red. size	A	B	C
		Ø	nr.1
125	5	138	M6
140	5	155	M6
160	6	178	M8
180	6	175	M8
200	8	195	M8
225	8	195	M8
250	8	242	M8
280	9	242	M8
320, 321	9	310	M8
360	9	310	M8

UT. C 2407

1) The labyrinth disc overhangs from A dimension compared with shaft shoulder; the length of low speed shaft end is equal to E - A (for dimension E see ch. 17 (1) and (2)).

17 - Accessories and non-standard designs

Notes.

- The compound of seal rings is acrylonitrilic as standard; on request, seal rings with fluoro compound are available (e.g.: for high temperatures, for aggressive environments or for high rotation speed, etc.); specify in the designation: **seal with fluoro compound**.
- The **double seal of high speed shaft** is generally **to be avoided** as the bigger localized heating reduces the life of seal; for gearmotors the design can be supplied only on the eventual double extension high speed shaft; for gear reducers, the design can be supplied according to the following scheme.

Size	Double seal on high speed shaft											
	R I		R 2I		R 3I		R CI		R ICI		R C2I	
	normal	double ext.	normal	double ext.	normal	double ext.	normal	double ext.	normal	double ext.	normal	double ext.
125	●	●	●	●	-	●	●	●	-	●	-	-
140	-	-	●	●	●	●	●	●	-	●	●	●
160	●	●	●	●	●	●	●	●	-	●	●	●
180	-	-	●	●	●	●	●	●	-	●	●	●
200, 225	-	-	●	●	●	●	●	●	-	●	●	●
250, 280	-	-	●	●	●	●	●	●	-	-	●	●
320 ... 360	●	●	●	●	-	●	●	●	-	-	●	●

- Design possible
- Design not possible; consult us, if need be.

- In case of **double seal**, the external seal ring can be counter mounted (e.g. in presence of water jets); specify in the designation: **external ring counter mounted**.
- The design **seal with labyrinth and high speed shaft greaser** can be supplied only after technical verification of feasibility by Rossi S.p.A.: consult us.
- The **hollow shaft with shrink disc** (see ch. 17 (6)) can be supplied with **labyrinth seal** only on **opposite side** to shrink disc; in this case foresee the «**hollow low speed shaft protection with shrink disc**» (see ch. 17 (7)); when this design is not available, consult us.
- For the additional description to the **designation** when ordering, see table on the previous page.

(27) Magnetic tap (sizes 125 ... 360)

In order to reduce lubricant contamination and to increase the maintenance interval and oil replacement, gear reducers and gearmotors size ≥ 125 can be supplied with magnetic plug.

In presence of oil drain tap (28) the oil drain magnetic plug is mounted in a second drain hole on housing and not in the tap.

Additional description when ordering by **designation: oil drain magnetic plug**.

(28) Oil drain tap (sizes 125 ... 360)

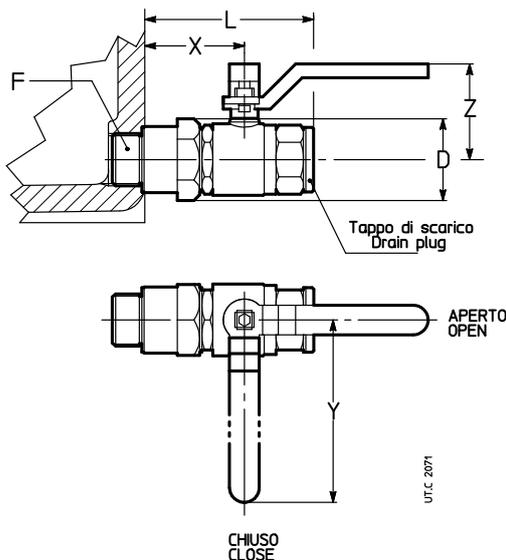

The gear reducers and gearmotors size ≥ 125 can be supplied with oil drain tap (accessory already assembled).

Additional description when ordering by **designation: oil drain tap**.

Gear reducer size	F	D Ø	L ≈	X	Y	Z
125, 140	G 1/2"	31	80	50	80	40
160 ÷ 280	G 3/4"	40	90	56	112	55
320 ÷ 360	G 1"	46	106	66	115	60

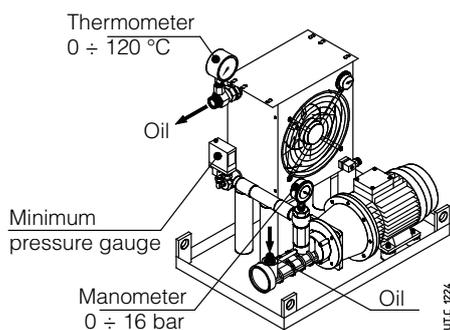
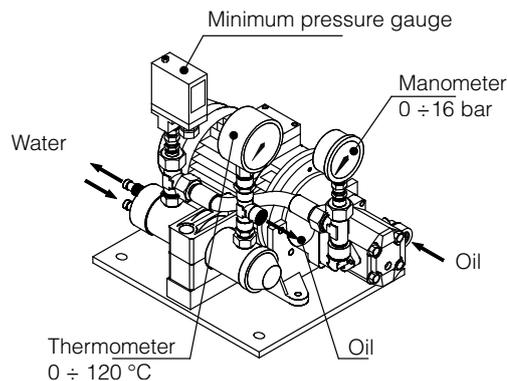
(29) Independent cooling unit**Oil/Air****Oil/Water**

Additional cooling device in the event that the other forced cooling systems are not sufficient for the dissipation of thermal power produced by gear reducer during operation (see ch. 4).

Including:

- **oil/air heat exchanger** (O/A; with thermostat and adjustable control knob 0 ÷ 90 °C) or **oil/water heat exchanger** (O/W),
- **motor pump**: screw pump with fluoro rubber seals (gear pump for UR O/W4 ÷ UR O/W 21); 4 pole motor B3/B5 (three-phase Δ230 Y400 V 50 Hz); motor-pump connection with coupling;
- **motor fan** (O/A) (three-phase supply Δ230 Y400 V 50 Hz or single phase supply 230 V 50, 60 Hz, see next table)
- **analogic manometer** (0 ÷ 16 bar) mounted between pump and exchanger;
- **analogic thermometer** (0 ÷ 120 °C) mounted at exchanger output;
- **low pressure switch** (with on-off switch) mounted between pump and exchanger;
- **supporting frame** with nameplate.

On request, several accessories are at disposal (supplied separately, assembled by Customer) in order to satisfy all functionality and safety needs.

- **oil temperature probe Pt100**;
- **2-threshold signalling device CT03** (necessary also the oil temperature probe Pt100) for the mounting on rail to DIN EN 50022;
- **3-threshold signalling device CT10** (necessary also the oil temperature probe Pt100) for the mounting on rail to DIN EN 50022;
- **bi-metal type thermostat**;
- **flow gauge**;
- **filter** (with optical-electric blockage warning and one or two filters M60)

Connections realized by flexible pipes (type SAE 100 R1, maximum length 2 m) between gear reducer and cooling unit and the assembly of accessories and signalling devices are Buyer's responsibility.

For the heat exchanger power required by the independent cooling unit:

$$P_s \geq (P_1 - P_{t_N} \cdot f_{t_1} \cdot f_{t_2} \cdot f_{t_3} \cdot f_{t_4}) \cdot (1 - \eta) \cdot K_1$$

where:

P_s nominal power of unit [kW], i.e. the power dissipable with hot oil at approx. 80 °C and cooling air at 40 °C (O/A) or cooling water at 20 °C (O/W) with stated capacity (see next table);

P_1 power at gear reducer input [kW] (consider the power installed when being uncertain about the power absorbed).

P_{t_N} nominal thermal power of gear reducer [kW] (see ch. 4);

f_{t_1} thermal factor according to input speed (see ch. 4);

f_{t_2} thermal factor according to ambient temperature (see ch. 4);

f_{t_3} thermal factor according to mounting position (see ch. 4);

f_{t_4} thermal factor according to altitude (see ch. 4); for UR O/A derate also the exchanger power: multiply P_s by 0,85 (for 1 000 ÷ 2 500 m a.s.l.) or by 0,71 (for 2 500 ÷ 5 000 m a.s.l.);

η gear reducer efficiency (see ch. 6);

$K_1 = 1,18$ takes into account the decrease of the exchanger efficiency due to dirt on the external surface.

17 - Accessories and non-standard designs

Designation	Ps kW	Exchanger	Oil motor pump		Motor fan		Oil connections		Exchanger capacity dm ³	Mass kg	
			motor 3~ kW	flow dm ³ /min	motor kW	flow m ³ /h	intake	delivery			
UR O/A 5	5	AP 300E	1,5	30	0,12	1~	900	1" (1"1/4) ²⁾	1" (1"1/4) ²⁾	2	60
UR O/A 7	7	AP 300/2E	1,5	30	0,12	1~	1300			3,6	65
UR O/A 10	10	AP 430E	1,5	30	0,21	3~	2750			3,6	70
UR O/A 13	13	AP 430/2E	1,5	30	0,18	3~	2700			5,5	75
UR O/A 16	16	AP 580 EB	2,2	56	0,18	3~	3500			15	96
UR O/A 21	21	AP 680 EB	2,2	56	0,69	3~	6300			16	118
UR O/A 26	26	AP 730 EB	3	56	0,69	3~	7450	1" 1/4	1" 1/2 (1") ¹⁾	16	127
UR O/A 30	30	AP 730 EB	3	80	0,69	3~	7450			16	127
UR O/A 40	40	AP 830 EB	2,2	56	0,81	3~	9500			20	140
UR O/A 46	46	AP 830 EB	3	80	0,81	3~	9500			20	140

Designation	Ps kW	Exchanger	Oil motor pump		Water		Oil connections		Exchanger capacity dm ³	Mass kg
			motor 3~ kW	flow dm ³ /min	flow dm ³ /min	connection	intake	delivery		
UR O/W 4	4	T60CB1	0,37	16	≥ 8 (≤ 30)	Ø 12	G 1/2"	G 1/2"	0,4	13
UR O/W 6	6	T60CB2	0,37	16	≥ 10 (≤ 30)	Ø 12	G 1/2"	G 1/2"	0,6	15
UR O/W 9	9	T80CB2	0,55	16	≥ 16 (≤ 30)	Ø 12	G 1/2"	G 1/2"	1	18
UR O/W 13	13	MS84P2	1,1	30	≥ 25 (≤ 45)	G 1/2"	G 3/4"	G 3/4"	1	31
UR O/W 21	21	MS134P1	1,5	30	≥ 40 (≤ 110)	G 1"	G 3/4"	G 3/4"	3	44
UR O/W 31	31	MS134P1	2,2	56	≥ 50 (≤ 110)	G 1"	G 1"1/4	G 1"1/4	3	55
UR O/W 50	50	MS134P2	3	80	≥ 80 (≤ 110)	G 1"	G 1"1/4	G 1"1/4	4,5	70

Starting mode and required accessories

Ref.	Gear reducer lubrication system	Gear reducer starting mode	T _{amb} °C	Required accessories	Required oil type	Description and remarks
A1	Splash lubrication	Without oil pre-heating	0 ÷ 25	Pt100 + CT10	Mineral oil or synthetic oil (preferable)	Gear reducer starting and subsequent motor-pump starting with warm oil. The motor-pump is managed by the three-threshold oil temperature control system (Pt100 + CT10). Set the three-threshold device CT10 with: – operating temperature 60 °C (starting of motor-pump); – restoring temperature 40 °C; – warning temperature 90° C.
A2	Splash lubrication	Without oil pre-heating	> 25	–	Polyalphaolefine based synthetic oil	Simultaneous starting of gear reducer and motor-pump Oil filter not possible ⁴⁾ .
B1	Forced lubrication (bearings and/or gears)	With oil pre-heating	0 ÷ 25	Pt100 + CT03 Pt100 + CT10 Oil heater	Mineral oil or synthetic oil (preferable)	Simultaneous starting of gear reducer and motor-pump after oil pre-heating³⁾. The oil heater is managed by the two-threshold oil temperature control system (Pt100 + CT03). The motor-pump and the gear reducer motor are managed by the three-threshold oil temperature control system (Pt100 + CT10). Set the two-threshold device CT03 with: – operating temperature 50 °C (oil heater disconnection); – restoring temperature 30° C. Set the three-threshold device CT10 with: – operating temperature 40 °C (starting of motor-pump and gear reducer motor); – restoring temperature 10 °C; – warning temperature 90° C.
B2	Forced lubrication (bearings and/or gears)	Without oil pre-heating	> 25	–	Polyalphaolefine based synthetic oil	Simultaneous starting of gear reducer and motor-pump³⁾ Oil filter not possible ⁴⁾ .

1) Connection for delivery UR O/A 16.

2) Connection for delivery in case of filter.

3) It is advisable to delay the gear reducer motor starting by at least 1 min compared to the motor pump starting.

4) The oil filter requires that cooling unit is started with oil already warm: refer to case A1 or B1.

Additional description when ordering by **designation**:

independent oil-air cooling unit UR O/A ... or **independent oil-water cooling unit UR O/W ...**, possibly integrated, when required by the application, with description: «**Forced lubrication ...**» and the statement of bearings and/or gear pairs to be lubricated. For dimensions, accessories and further technical details, see specific literature.

17 - Accessories and non-standard designs

(30) Oil temperature probe (sizes 125 ... 360)

Remote oil temperature gauge; installation (at Buyer's responsibility) instead of an existing drain plug, or into a hole properly pre-arranged. The temperature gauge is realized with a thermo-resistor Pt100 having following features:

- platinum wire with 100 Ω at 0 °C according to EN 60751;
- precision class B according to EN 60751;
- operation temperature field -40 °C ÷ 200 °C;
- max current 3 mA;
- 3 wires connection according to IEC 751 (see fig. below);
- stainless steel probe AISI 316; diameter 6 mm;
- cable 1 m long with free end.

For the connection of probe to relevant signalling device CT03 or CT10 (on request, consult us) use a protected section cable $\geq 1,5 \text{ mm}^2$ positioned separately from power cables.

In case of gear reducer supplied with oil and optional oil temperature probe, for the assembly of the same probe.

It is necessary to position the gear reducer so that the probe seating hole is upwards; if this is not possible, it is necessary to arrange a probe already equipped with a bulb pre-assembled in the factory, whose position has to be agreed in advance with Rossi; consult us.

Supplementary description when ordering by **designation: oil temperature probe**.

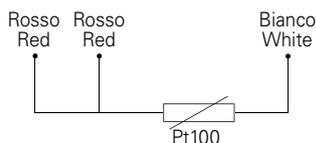

Gear reducer size	B	Ch (key)	D
125, 140	8	22	G 1/2"
160 ... 280	10	32	G 3/4"
320 ... 360	15	36	G 1"

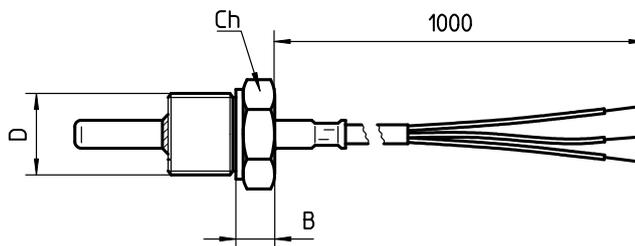

UTC 2103

17 - Accessories and non-standard designs

(31) Oil temperature probe with terminal box and amperometric transducer 4 ÷ 20 mA (sizes 125 ... 360)

Remote oil temperature gauge, with terminal box and amperometric transducer; installation (at Buyer's responsibility) instead of drain plug. The temperature gauge is realized with a thermo-resistor Pt100 having following features:

- platinum wire with 100 Ω at 0 °C according to EN 60751;
- precision class B according to EN 60751;
- temperature range -40 °C ÷ 200 °C;
- 3 wires connection according to IEC 751 (see fig. below);
- stainless steel probe AISI 316; diameter 6 mm;
- amperometric transducer with output signal 4 ÷ 20 mA;
- aluminium terminal block (supplied without cable gland);
- protection IP65;
- input cables G 1/2".

For the connection of probe to relevant signalling device use a protected section cable $\geq 1,5 \text{ mm}^2$ positioned separately from power cables.

ATTENTION. Accessory available only for technical feasibility evaluation by Rossi S.p.A.: consult us.

In case of gear reducer supplied with oil and optional oil temperature probe, for the assembly of the same probe.

It is necessary to position the gear reducer so that the probe seating hole is upwards; if this is not possible, it is necessary to arrange a probe already equipped with a bulb pre-assembled in the factory, whose position has to be agreed in advance with Rossi; consult us.

Supplementary description when ordering by **designation: oil temperature probe with terminal box and amperometric transducer.**

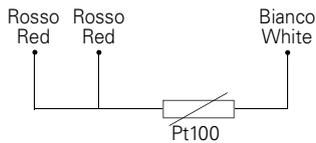

Gear reducer size	B	Ch (key)	b	D
125, 140	90	24	60	G 1/2"
160 ... 280	92	32	62	G 3/4"
320 ... 360	97	36	67	G 1"

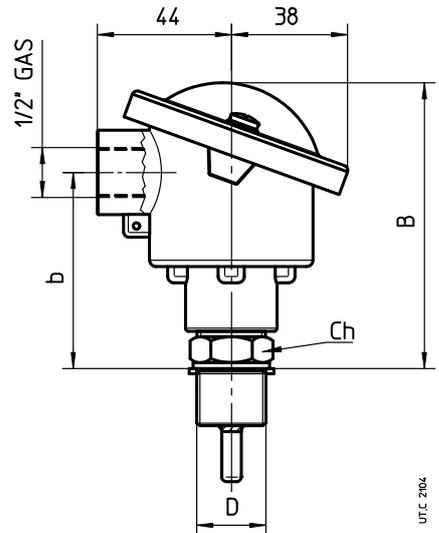

UTC 2004

17 - Accessories and non-standard designs

(32) Bearing temperature probe (sizes 125 ... 360)

Probe for the remote monitoring of bearing temperature; installation (at Buyer's responsibility) into a hole properly pre-arranged, next to a bearing to **be agreed during order phase** (for the most common cases, in order to facilitate the identification of bearing to be monitored, refer to following scheme).

The temperature gauge is realized with a thermo-resistor Pt100 having following features:

- platinum wire with 100 Ω at 0 °C according to EN 60751;
- precision class B according to EN 60751;
- temperature range -40 °C ÷ 200 °C;
- max current 40 mA;
- 3 wire connection according to IEC 751 (see fig. below);
- stainless steel AISI 316 flat probe; diameter 6 mm;
- stainless steel sliding fillet.

Not available for ICI and C3I train of gears.

For gearmotors, positions A1 and A2 not available.

For the connection of probe to relevant signalling device CT03 or CT10 use a protected section cable $\geq 1,5$ mm² positioned separately from power cables.

Supplementary description when ordering by **designation: bearing temperature probe**.

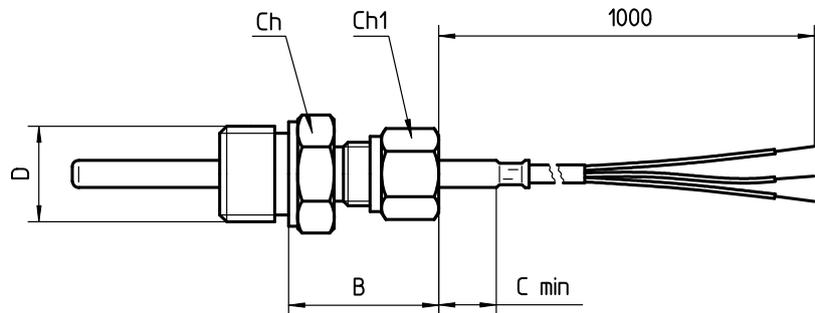
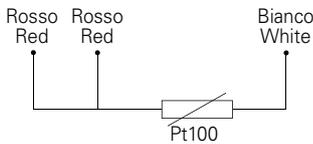

Gear reducer size	C _{min}	B	Ch (key)	Ch1 (key)	D
125, 140	5	32	24	17	G 1/2"
160 ... 280		36	32	27	G 3/4"
320 ... 360		40	36	27	G 1"

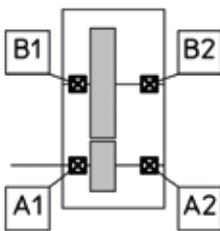

I ... UP2A

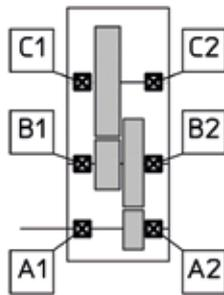

2I ... UP2A

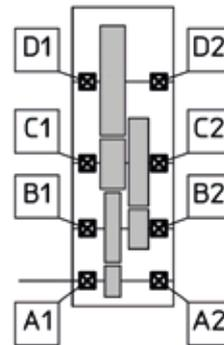

3I ... UP2A

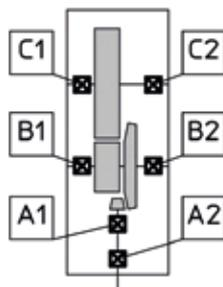

CI ... UO2A (UO2V)

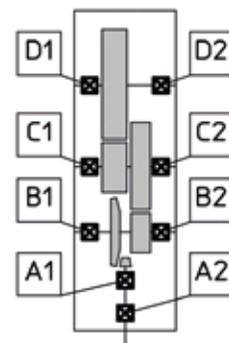

C2I ... UO2A (UO2V)

UTC 205

UTC 212

17 - Accessories and non-standard designs

(33) Bearing temperature probe with terminal box and amperometric transducer 4 ÷ 20 mA (sizes 125 ... 360)

Probe for remote bearing temperature monitoring, with terminal box and amperometric transducer; installation (at Buyer's responsibility) in a threaded hole properly pre-arranged next to a bearing **to be agreed when ordering** (for the most common cases, in order to facilitate the identification of the bearing to be monitored, it is possible to refer to the scheme at (32)).

The temperature gauge is realized with a thermo-resistor Pt100 having following features:

- platinum wire with 100 Ω at 0 °C according to EN 60751;
- precision class B according to EN 60751;
- temperature range -40 °C ÷ 200 °C;
- 3 wire connection according to IEC 751 (see fig. below);
- amperometric transducer with output signal 4 ÷ 20 mA;
- aluminium terminal block (supplied without cable gland);
- protection IP65;
- input cables G 1/2";
- stainless steel AISI 316 flat probe; diameter 6 mm;
- stainless steel **sliding** fillet.

For the connection of probe to relevant signalling device use a protected section cable $\geq 1,5 \text{ mm}^2$ positioned separately from power cables.

Not available for ICI and C3I train of gears.

For gearmotors, positions A1 and A2 not available.

Supplementary description when ordering by **designation**: bearing temperature probe with **amperometric transducer**.

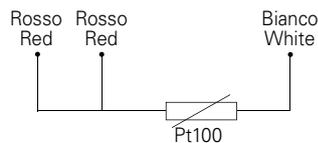

Gear reducer size	B	b	Ch (key)	Ch1 (key)	D
125, 140	134	104	24	17	G 1/2"
160 ... 280	138	108	32	27	G 3/4"
320 ... 360	142	112	36	27	G 1"

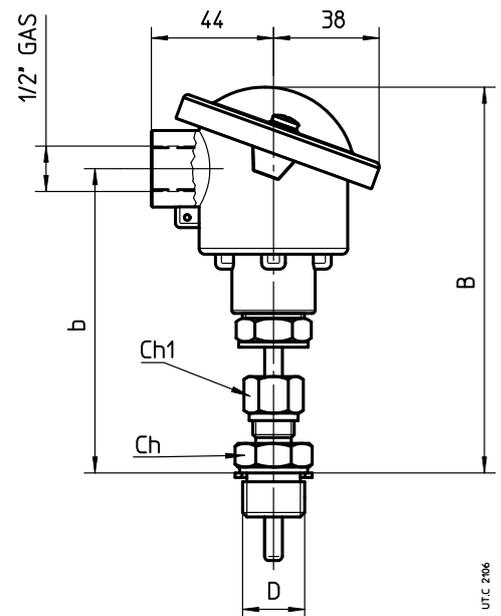

UTC 206

17 - Accessories and non-standard designs

(34) Bi-metal type thermostat (sizes 100 ... 360)

Gear reducers and gearmotors sizes ≥ 100 can be supplied with bimetal type thermostat for the control of the maximum admissible oil temperature.

Thermostat specifications:

- NC contact with maximum alternate current 10 A - 240 V d.c. (5 A - 24 V d.c.);
- G 1/2" thread connection;
- Pg 09 DIN 43650 cable gland;
- IP65 protection;
- Setting temperature $90\text{ }^{\circ}\text{C} \pm 5\text{ }^{\circ}\text{C}$ (other setting temperatures are possible, on request);
- Differential temperature $15\text{ }^{\circ}\text{C}$.

Mounting into a threaded hole (position to be defined according to mounting position and mounting arrangement: consult us) and oil bath lubrication is Buyer's responsibility.

ATTENTION. Accessory available only for technical feasibility evaluation by Rossi S.p.A.: consult us.

Supplementary description when ordering by **designation: bimetal type thermostat.**

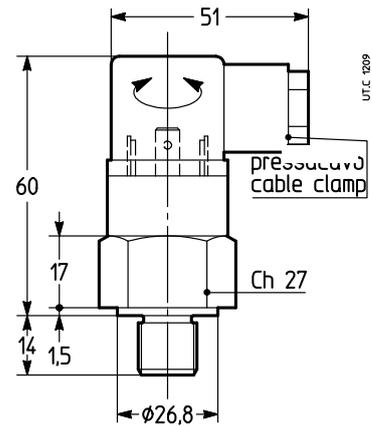

(35) Oil level switch with float (sizes 125 ... 360)

It is a level control device with reed contacts in a supporting stem moved by the magnetic field activated by the magnets included in the float.

The float and the supporting stem are included in a hollow column of not magnetic material connected to the gear reducer housing through communicating vessels.

Connecting features:

- 2 wires connection;
- maximum voltage: 350 V
- maximum current: 1.5 A
- 1 cable input 1/2" UNI 6125 - IP65
- G 1" brass joint.

The switch is supplied ready for use; when level goes down approx 5 mm, the switch goes on and contact opens.

When filling oil in the gear reducer it is necessary to verify that device is properly calibrated. If any problems occur during this operation contact Rossi.

ATTENTION. Accessory available only for technical feasibility evaluation by Rossi S.p.A.: consult us.

Supplementary description when ordering by **designation: oil level switch with float**

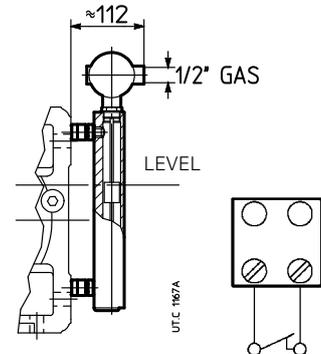

(36) Oil optical probe (sizes 125 ... 360)

Optical scanner, without mobile parts, for the constant control of oil level, inside the gear reducer (at rest).

Features:

- stainless steel probe;
- operating temperature range $-40\text{ }^{\circ}\text{C} + 125\text{ }^{\circ}\text{C}$
- d.c. supply $12 \div 28\text{ V}$ (other types on request, consult us);
- PNP output (other types on request, consult us), max 100 mA;
- male coupling G 3/8", G 1/2", G 3/4", G 1" according to gear reducer size.

Supplementary description when ordering by **designation: oil optical probe.**

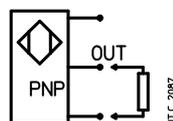
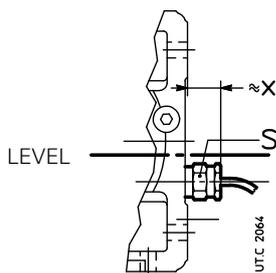

Gear reducer size	S	x
125... 140	27	40
160 ... 360	36	45

17 - Accessories and non-standard designs

(37) Gear reducer design ATEX II 2 GD and 3 GD (sizes 40 ... 360)

Helical (excluding model 4) and bevel helical gear reducers and gearmotors may be supplied according to European Community Directive ATEX 94/9/EC in order to be used in potentially explosive atmospheres – category **2 GD** (for operation in zones 1 (gas), 21 (dust): **probable** presence of explosive atmosphere) and **3 GD** (for operation in zones 2 (gas), 22 (dust): **improbable** presence of explosive atmosphere) – with surface temperature $T \leq 135 \text{ °C}$ (T4).

These are the main variations of the product:

- fluoro-rubber seal rings;
- metal plugs; filler plug with filter and valve;
- special name plate with ATEX mark and indication of application limits;
- external protection based on a water-soluble dual-compound polyurethane **conductive** enamel, **color grey** RAL 7040, corrosivity class C3 ISO 12944-2;
- «ATEX instructions» manual.

For category **2 GD**¹⁾, depending on **minimum control intervals**, also:

2 GD monthly control

- double seal rings on low speed shaft;

2 GD quarterly control (sizes 125 ... 360):

- double seal rings on low speed shaft;
- oil temperature probe;
- possible bearing temperature probes.

This solution is advisable when the gear reducer has difficult access or when a decrease in control frequency is desired.

Temperature range: $-20 \div +40 \text{ °C}$ ($0 \div +40 \text{ °C}$ for gear reducers supplied with bearing lubrication pump).

The «**ATEX instructions**» (with the additional documentation, if any) are **integral part of the supply of each gear reducer**; every indication stated in it must be carefully applied. Consult us if need be.

Attention. In the following cases ATEX design of gear reducer is incompatible with accessories and non-standard designs:

Accessory or non-standard design	Gear reducer ATEX II design	
	2 GD	3 GD
Hollow low speed shaft with shrink disc (6)	●	●
Optional paint according to cycles 3H..., 2L..., 2L... (24)	–	–
Heater (25)	○	○
Labyrinth seal and greaser (26)	–	●
Independent cooling unit (29)	–	–
Oil temperature probes (30) (31)	○	○
Bearing temperature probes (32) (33)	○	○
Bi-metal type thermostat (34)	–	–
Oil level switch with float (35)	2)	●
NEMA C-Face adapter (38)	–	–
Torque limiters (Miscellaneous)	–	–

Gear reducer size selection

Determine the size of gear reducer as indicated in ch. 5 considering following additional indications:

- **maximum input speed** $n_1 < 1\,500 \text{ min}^{-1}$;
- **service factor required** determined as per ch. 3, increased by table correction factor fs_{ATEX} (see table 1) and anyway **never lower than 1**; in presence of a hollow shaft with shrink disc (6) verify that maximum peak torque is always lower than $M_{2SD} / f_{S ATEX}$ (for M_{2SD} values see ch. 17(6)).
- thermal power P_t verified as per ch. 4 according to nominal thermal power P_{tN} increased by thermal factors $ft_1^{3)}$... ft_4 and ft_{ATEX} corrective factor (see table 1).

Table 1 - Corrective factors for ATEX design of service factor required and of nominal thermal power

Category	fs_{ATEX}	ft_{ATEX}
2 GD	1,18	0,8 (0,71 for I and CI)
3 GD	1,06	0,9 (0,8 for I and CI)

– Not available.

● Available.

○ Available but in ATEX design suitable for gear reducer's ATEX design and for use purpose and area.

1) **The presence of bearing lubrication pump requires one or more additional bearing temperature probes.**

2) This accessory is available for category 2 G (zone 1) only.

3) When determining ft_1 consider a value of ft_{1a} (see page 28) **never exceeding 1**.

17 - Accessories and non-standard designs

Motor category selection

In the table on the right the minimum features of motors to be installed with Rossi gear reducers in ATEX design, in potentially explosive atmosphere areas.

Protection methods of electric tools:

EEx **e** increased safety;
 EEx **d** flameproof enclosure;
 EEx **de** combination of «d» and «e»;
 EEx **nA** reduced sparking

Zone	Rossi gear reducer in ATEX I design ¹	Required motor category ¹⁾
1	2 GD	2 G EEx e 2 G EEx d 2 G EEx de
21		2 D IP65
1, 21		2 GD EEx e 2 GD EEx d 2 GD EEx de
2	3 GD	3 G EEx nA –
22		3 D IP54 ²⁾ –
2, 22		3 GD EEx nA

Supplementary description when ordering by **designation**³⁾:

design ATEX II ...

... **3 GD T4** sizes 40 ... 360
 ... **2 GD T4 monthly control** sizes 40 ... 360
 ... **2 GD T4 quarterly control** sizes 125 ... 360

1) The devices suitable for zone 1 are also suitable for zone 2, similarly the devices suitable for zone 21 are also suitable for zone 22.

2) For conductive dusts motor must be 2 D IP65.

3) This designation, in case of gearmotor, refers to the gear reducer part only.

17 - Accessories and non-standard designs

(38) NEMA C-Face adapter (IEC motor sizes 63 ... 100)

Accessory for the transformation of motor coupling dimensions, at gearmotor input, from IEC to NEMA C-Face; available for IEC-NEMA motor size combinations stated in the table; other combinations on request; consult us. Mounted on gear reducer.

For the **verification of maximum flange bending moment MR** (see ch. 6) it is necessary to add the value of Y2 [mm] to HF dimension (ch. 6) and include in the mass of motor NEMA [kg] the mass of adapter [kg].

Supplementary description when ordering by **designation: MPN ...** (see table below).

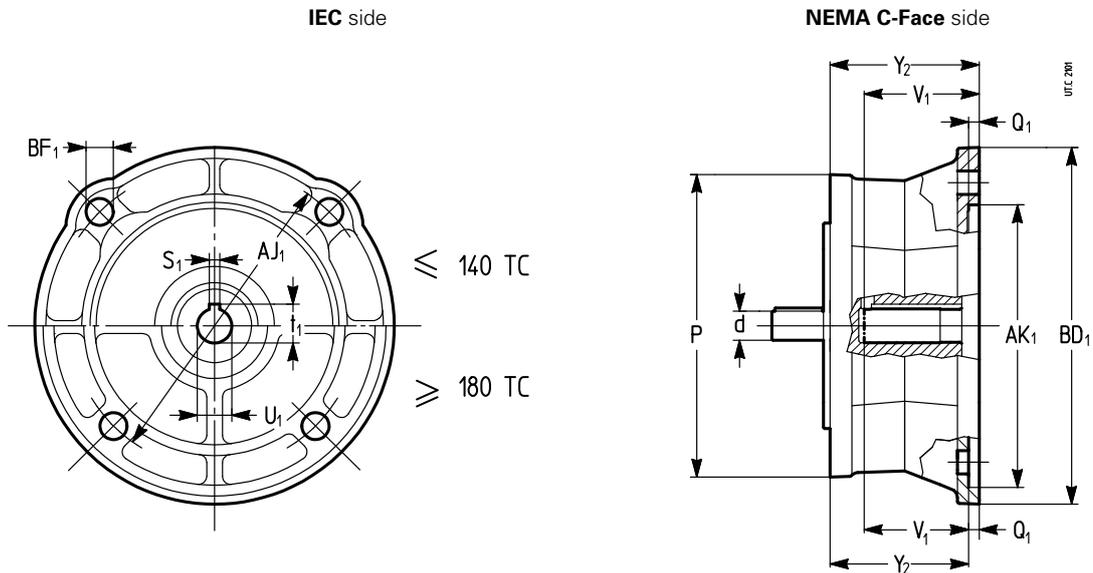

IEC side		NEMA C-Face side											Designation code	
d x P ∅ ∅	Motor size IEC	NEMA motor size	U ₁ ∅ 1) mm in	V ₁ mm in	S ₁ 2) mm in	t ₁ mm in	BF ₁ ∅ mm in	AJ ₁ ∅ mm in	AK ₁ 3) mm in	BD ₁ mm in	Q ₁ mm in	Y ₂ mm in		kg lb
11x140	63B5	56 C	15,9 0,625	52,3 2,06	4,8 0,188	18,0 0,709	10,9 0,43	149,2 5,875	114,3 4,5	165,1 6,5	5,1 0,2	68,6 2,7	3,1 6,9	MPN 63 B5 - 56 C
14x140	71B5A	56 C	15,9 0,625	52,3 2,06	4,8 0,188	18,0 0,709	10,9 0,43	149,2 5,875	114,3 4,5	165,1 6,5	5,1 0,2	68,6 2,7	3,1 6,9	MPN 71 B5A - 56 C
14x160	71B5	56 C	15,9 0,625	52,3 2,06	4,8 0,188	18,0 0,709	10,9 0,43	149,2 5,875	114,3 4,5	165,1 6,5	5,1 0,2	68,6 2,7	3,4 7,5	MPN 71 B5 - 56 C
19x160	80B5A	56 C	15,9 0,625	52,3 2,06	4,8 0,188	18,0 0,709	10,9 0,43	149,2 5,875	114,3 4,5	165,1 6,5	5,1 0,2	68,6 2,7	3,4 7,6	MPN 80 B5A - 56 C
19x200	80B5	56 C	15,9 0,625	52,3 2,06	4,8 0,188	18,0 0,709	10,9 0,43	149,2 5,875	114,3 4,5	165,1 6,5	5,1 0,2	68,6 2,7	4,4 9,6	MPN 80 B5 - 56 C
19x160	80B5A	140 TC	22,2 0,875	53,8 2,12	4,8 0,188	24,5 0,964	10,9 0,43	149,2 5,875	114,3 4,5	165,1 6,5	5,1 0,2	68,6 2,7	3,4 7,4	MPN 80 B5A - 140 TC
24x200	90B5	56 C	15,9 0,625	52,3 2,06	4,8 0,188	18,0 0,709	10,9 0,43	149,2 5,875	114,3 4,5	165,1 6,5	5,1 0,2	68,6 2,7	4,4 9,8	MPN 90 B5 - 56 C
19x200	90B5R	140 TC	22,2 0,875	53,8 2,12	4,8 0,188	24,5 0,964	10,9 0,43	149,2 5,875	114,3 4,5	165,1 6,5	5,1 0,2	68,2 2,7	4,3 9,4	MPN 90 B5R - 140 TC
24x200	90B5	140 TC	22,2 0,875	53,8 2,12	4,8 0,188	24,5 0,964	10,9 0,43	149,2 5,875	114,3 4,5	165,1 6,5	5,1 0,2	68,2 2,7	4,4 9,6	MPN 90 B5 - 140 TC
19x200	90B5R	180 TC	28,6 1,125	66,5 2,62	6,4 0,25	31,5 1,241	14,2 0,56	184,2 7,25	215,9 8,5	228,6 9	5,6 0,22	85,1 3,35	7,7 16,9	MPN 90 B5R - 180 TC
24x200	90B5	180 TC	28,6 1,125	66,5 2,62	6,4 0,25	31,5 1,241	14,2 0,56	184,2 7,25	215,9 8,5	228,6 9	5,6 0,22	85,1 3,35	7,8 17,1	MPN 90 B5 - 180 TC
28x250	100B5	180 TC	28,6 1,125	66,5 2,62	6,4 0,25	31,5 1,241	14,2 0,56	184,2 7,25	215,9 8,5	228,6 9	5,6 0,22	85,1 3,35	9,3 20,5	MPN 100 B5 - 180 TC
24x200	100B5R	210 TC	34,9 1,375	79,2 3,12	7,9 0,312	38,6 1,518	14,2 0,56	184,2 7,25	215,9 8,5	228,6 9	5,6 0,22	120,4 4,74	9,2 20,3	MPN 100 B5R - 210 TC
28x250	100B5	210 TC	34,9 1,375	79,2 3,12	7,9 0,312	38,6 1,518	14,2 0,56	184,2 7,25	215,9 8,5	228,6 9	5,6 0,22	120,4 4,74	10,8 23,9	MPN 100 B5 - 210 TC
28x250	132B5R	250 TC	41,3 1,625	95,3 3,75	9,5 0,375	45,6 1,796	14,2 0,56	184,2 7,25	215,9 8,5	254,0 10	5,6 0,22	120,4 4,74	13,8 30,4	MPN 132 B5R - 250 TC

1) Tolerance 0/+0,025 mm (0/+0,0010 in).

2) Tolerance 0/+0,051 mm (0/+0,0020 in).

3) Tolerance -0,018/+0,025 mm (-0,0007/+0,0010 in).

17 - Accessories and non-standard designs

Miscellaneous

– Synchronous multiple drives:

gear reducers and gearmotors with trains of gears ICI sizes 50 ... 100 can be applied for multiple drives together with same size gear reducers, all having the same transmission ratio (see also ch. 10);

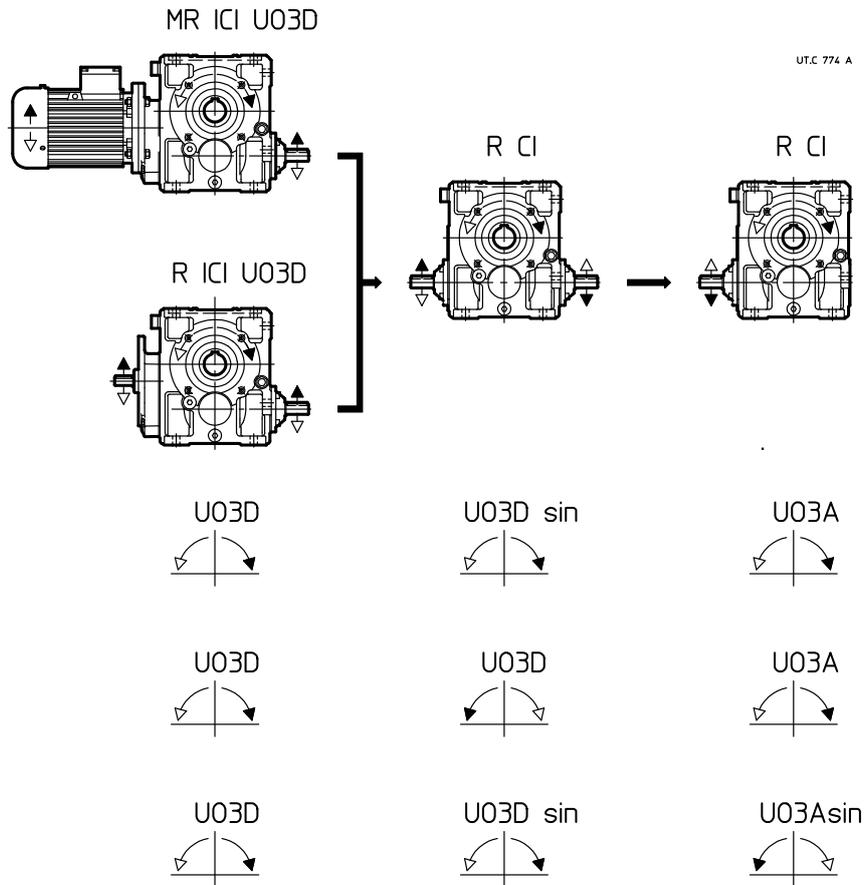

On request, gear reducers R CI can be supplied also for sizes 125 ... 200. In this case, after defining the size and the initial gear reducer or gearmotor transmission ratio ICI, the gear reducers R CI must be selected with this same size and transmission ratio resulting from the one of the initial gear reducer divided by the transmission ratio of the first helical reduction stage; the performance keep the same of initial ICI gear reducer or gearmotor.

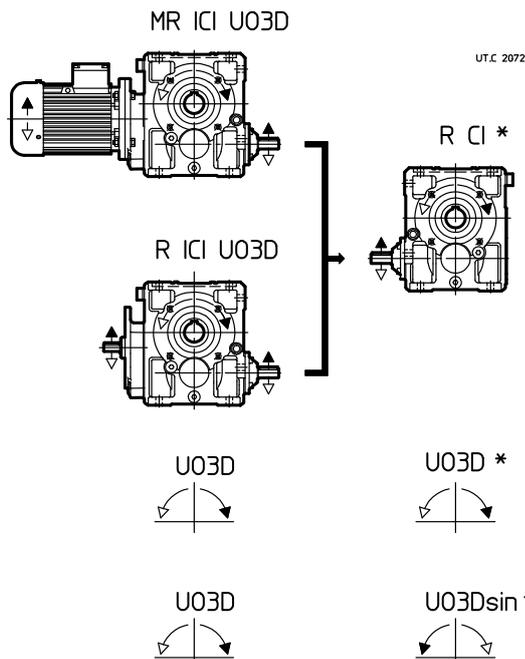

* Gear reducers R ICI ... with design U03 ... without helical first reduction stage

17

- Designs (direction of rotation), dimensions and mounting positions of gear reducers R CI 125 ... 200 U03A ... U03Esin can be deduced from the ones of the similar gear reducers R ICI (see ch. 10).
- If necessary, consult us.

17 - Accessories and non-standard designs

- Gearmotors with:
 - **brake motor** (also single phase) with d.c. **safety and/or parking brake** (sizes 63 ... 132) with overall dimensions equal to the ones of standard motor and braking torque $M_f \geq M_N$, maximum cost-effectiveness;
 - **two speed motor** (standard, brake, brake with safety and/or parking brake, with flywheel) with 2.4, 2.6, 2.8, 2.12, 4.6, 4.8, 6.8 poles;
 - motor featuring: d.c. supply; single-phase; explosion-proof; with second shaft end; with special protection, voltage and frequency; provided with devices against overloads and overheating;
 - **motor without fan** with external cooling **by natural convection** (sizes 63 ... 112); design usually realized for textile environment;
 - **motor for roller ways** (see cat. S) with cooling fins by natural convection, no plastic parts, electromagnetic sizing and specific insulation system for drive with inverter and nominal torque constant on all frequency range;

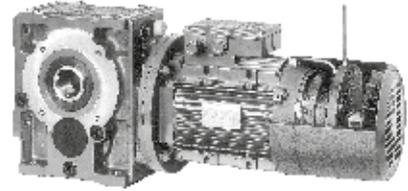
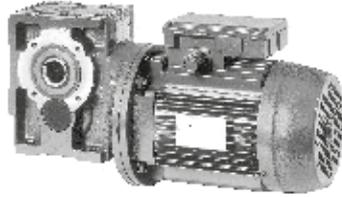

- Design with 2^a **motorization** with identical speed (**same** or different direction of rotation) or **reduced** (same direction of rotation, free-wheel coupling) (see picture); for sizes 320 ... 360 the 2nd motorization is realized with bevel helical gearmotor connected with bevel wheel shaft end;

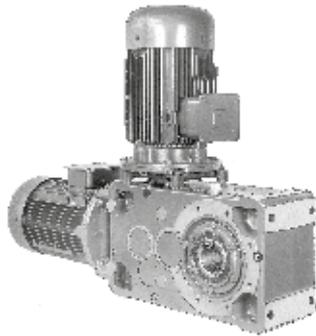

- Housing with B14 flange **on two faces** (train of gears 2I, 3I and 4I sizes 63 ... 125);
- Input centering (h8) for R CI, R C2I;
- Long model gearmotors sizes **250 ... 360**;
- Gearmotors with interposed compact clutch-brake or fluid coupling/ brake unit;
- Fitting with key, bronze bushing and shrink disc of CI, C2I trains of gears or motor size ≤ 200 ;
- Semi-flexible and hydrodynamic couplings;
- Design for MR 2I with **through** low speed shaft;
- Pre-arranged for bearing and gear forced lubrication.

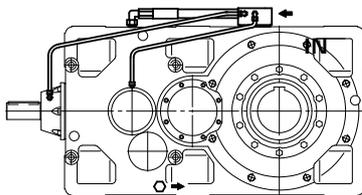

OUT

- (Standard and brake) motor design ATEX 2 GD EExd, 3GD EEx nA.
- Gear reducers (excluding R I) and gearmotors with output **mechanical torque limiter** on gear reducer sizes **50 ... 125** (excluding sizes 64, 81). Gear reducer design with mechanical friction type torque limiter (friction surfaces without asbestos), compact, with high transmissible torque – up to **1 600 N m** – and top quality standards.

It protects the drive from accidental overloads by excluding the effect of inertia loads transmitted from up-line masses and (the torque limiter being mounted on the output shaft) inertia loads transmitted from down-line masses.

17 - Accessories and non-standard designs

The system also permits **shaft mounting** with the limiter mounted **externally** (easily accessible), or in the **intermediate** position (better safety protection).

On request slide detector. For more details see **specific literature**.

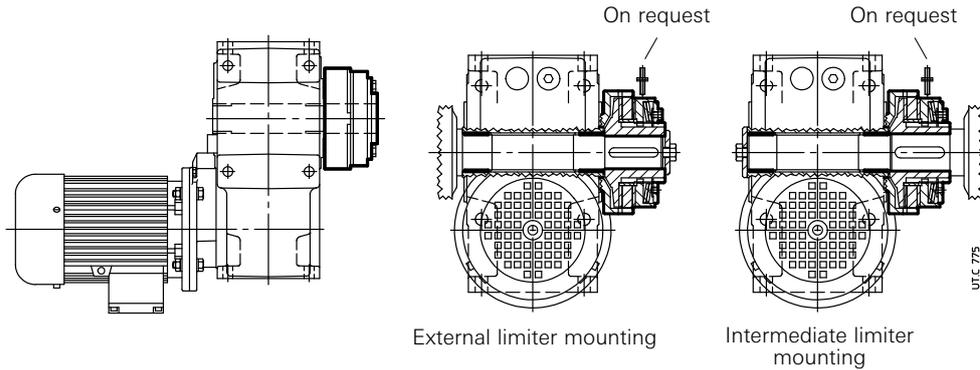

– **MLA and MLS unit, mechanical torque limiter on input shaft**, motor sizes **80 ... 200** (180 for MLS).

Mechanical torque limiter unit to be interposed between gear reducer and B5 mounting position motor standardized to IEC (or wide belt or planetary motor-variator) or, in combined units, between the initial coaxial gear reducer and the final gear reducer sizes **63 ... 280**.

Axially ultra-compact design: excellent load bearing with life lubricated double row angular contact ball bearings (motor size < 112) or «O» disposed taper roller bearings.

The unit protects the drive from accidental overloads by excluding inertia loads transmitted from up-line masses and down-line masses.

LA unit is friction type (friction surfaces without asbestos). When the transmitted torque tends to exceed the setting, the drive «slips» although it remains engaged and transmits torque equal to the limiter setting value; slipping stops as soon as the load returns to normal; in the case of very brief overloads the driven machine will continue normal operation (after decelerating or stopping) without requiring reset procedures.

LS unit is ball type. When the transmitted torque tends to exceed the setting, the drive is «disengaged» so it does not remain connected. The driven machine will therefore stop.

LA and LS units are mechanically interchangeable. On request slide detector. For more details see **specific literature**.

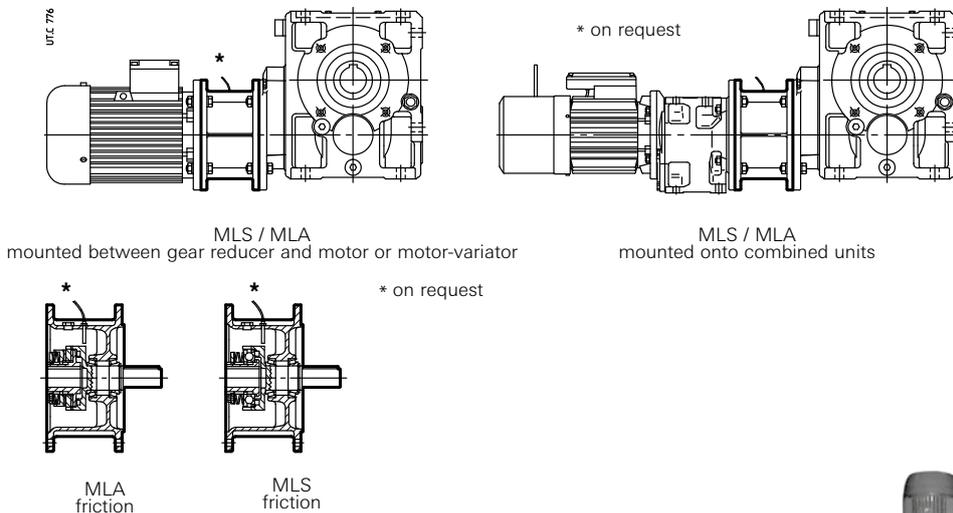

Special maintenance-free wearproof mechanical seal for MR 2I, 3I size ≥ 160 , for one direction of rotation only (patented).

Driving group complete of base - motor, coupling, brake if any, second drive for shaft - mounting arrangements (see cat. RE).

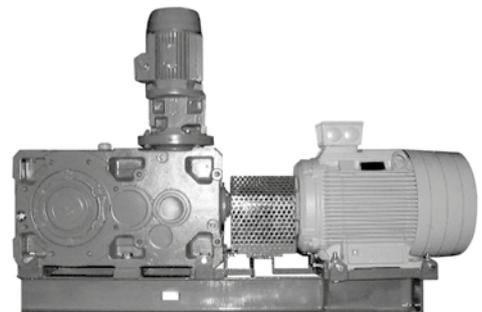

18 – Installation and maintenance

Safety	360
Generals	360
Shaft end of driven machine	361
Fitting of components to shaft end	361
Hollow low speed shaft.....	362
Lubrication	363
Motor assembly and disassembly.....	364
Shaft mounting arrangements	366
Fastening bolt dimensions for gear reducer feet	370
Tightening torque	370

18. Installation and maintenance

Safety

IMPORTANT: gear reducers and gearmotors supplied by Rossi are **components** to be incorporated into machinery and **should not be commissioned before the machinery in which the components have been incorporated conforms to:**

- Machinery directive 2006/42/EC and subsequent updates; in particular, possible safety guards for shaft ends not being used for eventually accessible fan cover passages (or other) are the Buyer's responsibility;
- «Electromagnetic compatibility (EMC)» 2004/108/EC and subsequent updates.

Attention! It is recommended to pay attention to all instructions of present catalog, all standards concerning correct installation and all existing safety laws. Whenever personal injury or property damage may occur, foresee adequate supplementary protection devices against:

- release or breakage of fastening screws;
- rotation or unthreading of the gear reducer from shaft end of driven machine following to accidental breakage of the reaction arrangement;
- accidental breakage of shaft end of driven machine.

If deviations from normal operation occur (temperature increase, unusual noise, etc.) immediately switch off the machine.

Installation

An incorrect installation, an improper use, the removing or disconnection of protection devices, the lack of inspections and maintenance, improper connections may cause severe personal injury or property damage. Therefore the component must be moved, installed, commissioned, handled, controlled, serviced and re-paired **exclusively by responsible qualified personnel specifically instructed** and have the experience necessary to **recognize** and prevent **dangers** connected to present products avoiding all possible emergencies.

Gear reducers and gearmotors of present handbook are normally suitable for installations in **industrial areas: additional protection** measures, if necessary, must be adopted and assured by the personnel responsible for the installation.

Attention! Components in non-standard design or with special executions or with constructive variations may differ in the details from the ones described here following and may require additional information.

Attention! For the installation, use and maintenance of the **electric motor** or of the eventual motor variator and/or electric supply device (frequency converter, soft-start etc.), and/or optional electric devices (e.g.: independent cooling unit, etc.), consult the attached specific documentation. If necessary, require it.

Maintenance

When operating on gear reducer or on components connected to it the **machine** must be **at rest**: disconnect motor (including auxiliary equipments) from power supply, gear reducer from load, be sure that safety systems are on against any accidental starting and, if necessary, pre-arrange mechanical locking devices (to be removed before commissioning).

Attention! During the running the gear reducers could have **hot surfaces**; always wait that the gear reducer or the gearmotor to cool before carrying out any operations.

Please download further technical documentation from our website www.rossi-group.com.

Generals

Be sure that the structure on which gear reducer or gearmotor is fitted is plane, levelled and sufficiently dimensioned in order to assure fitting stability and vibration absence, keeping in mind all transmitted forces due to the masses, to the torque, to the radial and axial loads.

Position the gear reducer or gearmotor so as to allow a free passage of air for cooling both gear reducer and motor (especially at gear reducer and motor fan sides).

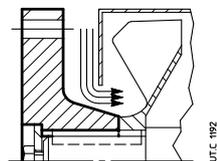

If there is fan on the gear reducer verify that there is sufficient space allowing an adequate circulation of cooling air also after fitting coupling protection. If a coupling protection is fitted, smooth the coupling hub, if necessary.

Avoid: any obstruction to the air-flow; heat sources near the gear reducer that might affect the temperature of cooling-air and of gear reducer for radiation; insufficient air recycle or any other factor hindering the steady dissipation of heat.

Mount the gear reducer so as not to receive vibrations.

When external loads are present use pins or locking blocks, if necessary.

When fitting gear reducer and machine and/or gear reducer and eventual flange **B5** it is recommended to use **locking adhesives** such as LOCTITE on the fastening screws (also on flange mating surfaces).

For outdoor installation or in a hostile environment protect the gear reducer or gearmotor with anticorrosion paint. Added protection may be afforded by water-repellent grease (especially around the rotary seating of seal rings and the accessible zones of shaft end).

Gear reducers and gearmotors should be protected wherever possible, and by whatever appropriate means, from solar radiation and extremes of weather; weather protection **becomes essential** when high or low speed shafts are vertically disposed, or where the motor is installed vertical with fan uppermost.

For ambient temperatures greater than 40 °C or less than 0 °C, consult us.

Before wiring-up the gearmotor, make sure that motor voltage corresponds to input voltage. If direction of rotation is not as desired, invert two phases at the terminals.

Star-delta starting should be adopted for starting on no load (or with a very small load) and/or when the necessity is for smooth starts, low starting current and limited stresses.

If overloads are imposed for long periods or if shocks or danger of jamming are envisaged, then motor-protection, electronic torque limiters, fluid couplings, safety couplings, control units or other similar devices should be fitted.

Usually protect the motor with a thermal cut-out; however, where duty cycles involve a high number of on-load starts, it is necessary to utilise thermal probes for motor protection (fitted on the wiring); thermal cut-out is unsuitable since its threshold must be set higher than the motor nominal current of rating.

Connect thermal probes, if any, to auxiliary safety circuits.

Use varistors to limit voltage peaks due to contactors.

Attention! Bearing life, good shaft and coupling running depend on alignment precision between the shafts. Carefully align the gear reducer with the motor and the driven machine (with the aid of shims if need be), interposing flexible couplings whenever possible.

Whenever a leakage of lubricant could cause heavy damages, increase the frequency of inspections and/or envisage appropriate control devices (e.g.: remote oil level gauge, lubricant for food industry, etc.).

In polluting surroundings, take suitable precautions against lubricant contamination through seal rings or other.

Gear reducer or gearmotor should not be put into service before it has been incorporated on a machine which is conform to 2006/42/EC directive.

For brake or special motors, consult us for specific information.

18. Installation and maintenance

Shaft end of driven machine

Dimensions of shaft end on which the gear reducer hollow shaft is to be keyed are those recommended in the table and shown in the figures below.

Sizes 40, 63: fitting with key (fig. a) or fitting with key and locking rings (fig. b).

Sizes 64 ... 360: fitting with key (fig. c) or fitting with key and locking bushing (fig. d); see also ch. 19 and 20; see also ch. 17.

In the case of cylindrical shaft end with only diameter D (fig. a, c), for the seat D on input side, we recommend tolerance h6, j6 (size < 225) or g6, h6 (size ≥ 250) to facilitate mounting.

Important: the shoulder diameter of the driven machine shaft end abutting with the gear reducer must be at least $(1,18 \div 1,25) D$.

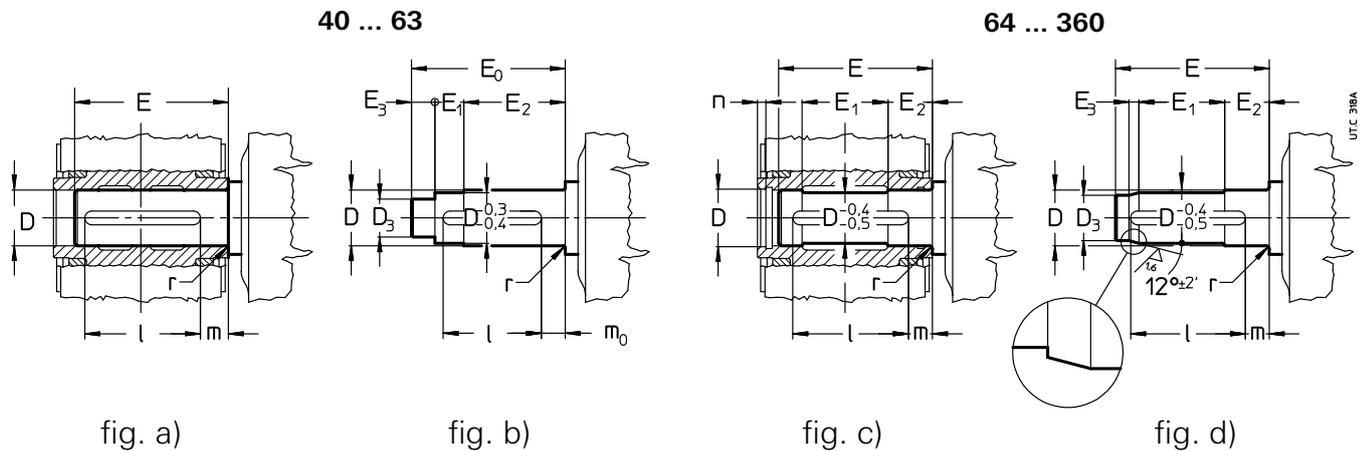

Gear reducer size	D Ø	D ₃ Ø H7/h6	E 2)	E ₀	E ₁	E ₂ 2)	E ₃	l	m	m ₀	n	r
40	H7/h6, j6 19	15	76,5	81	14	53	14	50	21	14	–	1,5
50	24	19	90,5	95	21	60	14	63	21,5	15	–	1,5
63	30 ¹⁾	25	107,5	112,5	19,5	72	21	63	31,5	25	–	1,5
64	32	27	110	–	57	34	10	70	28	–	6	1,5
80	38 ¹⁾	32	134	–	71	39,5	12	90	30	–	6	1,5
81	40	34	134	–	71	39,5	12	90	30	–	6	1,5
100	48	41	162	–	87	46,5	14	110	35	–	7	2
125	60	52	201	–	110	55	16	140	40	–	7	2
140	70 ¹⁾	62	228	–	124	63	16	180	35	–	8	2
160	80	70	250	–	136	68	21	200	36	–	8	3
180	90	80	274	–	150	75	21	200	50	–	9	3
200	100	88	308	–	174	80	25	250	42	–	10	3
225	110	98	331	–	180	90	25	250	55	–	10	3,5
250	H7/h6, j6 125	110	380	–	212	100	32	320	40	–	11	4
280	140	125	410	–	220	112	32	320	60	–	12	4
320, 321	160 ¹⁾	140	471	–	258	125	43	400	45	–	13	5
360	180	160	506	–	272	137	43	400	72	–	14	5

1) Keyway depth not to standard (see ch. 6 «Hollow low speed shaft» table, dimension t).

2) In presence of «Labyrinth seal and low speed shaft grease» (ch. 17 (26)), it is necessary to increase the E dimension (E₂) by A quantity stated in the table on ch. 17 (26).

Fitting of components to shaft end

It is recommended that the holes of parts keyed onto shaft ends should be machined to H7 tolerance; for high speed shaft ends having $D \geq 55$ mm, tolerance G7 is permissible provided that the load is uniform and light; for low speed shaft end, tolerance must be K7 if load is not uniform and light. Other data according to table «High and low speed shaft end» (ch. 6). Before mounting, clean carefully and lubricate mating surfaces against seizure and fretting corrosion.

Installing and removal operations should be carried out with **pullers** and **jacking screws** using the tapped hole at the shaft butt-end; for H7/m6 and K7/j6 fits it is advisable that the part to be keyed is preheated to a temperature of $80 \div 100$ °C.

18. Installation and maintenance

Hollow low speed shaft

In order to remove the hollow low speed shaft (this is the first operation to perform when disassembling the gear reducer) turn the shaft until the keyway is facing the intermediate shaft, as shown in the drawing alongside, and push the shaft from the reference groove side (see ch. 6).

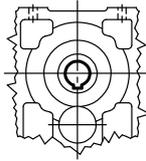

For the shaft end of machines where the gear reducer stepped hollow shaft is to be keyed, h6, j6 or k6 tolerances are recommended according to requirements. Other details are given under «High and low speed shaft end (ch. 6)» and «Shaft end of driven machine» (ch. 18).

In order to have an easier **installing and removing** of gear reducers sizes 64 ... 360 with retaining ring groove proceed as per the drawings a, b, respectively (excluding MR 3I 100 with motor size 112 and 3I 125 with motor size 132; consult us).

For MR 3I 64 ... 81 first insert the washer with screw and the retaining ring into gear reducer hollow shaft (on motor opposite side); then mount on machine shaft end.

For the axial fastening it is possible to adopt the system as per fig. c, d. For sizes 64 ... 360, when shaft end of driven machine has no shoulder, a spacer may be located between the retaining ring and the shaft end itself (as in the lower half of the fig. d).

The use of **locking rings** (sizes 40 ... 63, fig. e), or of **locking bushing** (sizes 64 ... 360, fig. f) will permit easier and more accurate installing and removing and to eliminate backlash between key and keyway, friction system **complying** with Atex.

The locking rings or the locking bushing should be inserted after mounting (for MR 3I 64 ... 81 insert the bushing onto machine shaft end or into hollow shaft before mounting; pay attention when positioning the keyway); the shaft end of driven machine must be as prescribed at the previous page (or at ch. 17(6)) with stepped hollow low speed shaft or with shrink disc). Do not use molybdenum disulphide or equivalent lubricant for the lubrication of the parts in contact. **When tightening the bolt**, we recommend the use of a **locking adhesive** LOCTITE 601. For **vertical ceiling-type** mounting consult us.

In case of axial fastening with locking rings or bushing – especially when having heavy duty cycles, with frequent reversals – verify, after some hours of running, the bolt tightening torque and eventually apply the locking adhesive again.

A **washer** for gear reducer installing, removing (excluding sizes 40 ... 63) and gear reducer axial fastening with or without **locking rings or bushing** (dimensions stated in table) and hollow low speed shaft **protection cap** can be supplied on request. Parts in contact with retaining ring, if any, must have sharp edges.

Whenever personal injury or property damage may occur, **foresee adequate supplementary protection devices** against:

- rotation or unthreading of the gear reducer from shaft end of driven machine following to accidental breakage of the reaction arrangement;
- accidental breakage of shaft end of driven machine.

Installing a) and removing b)

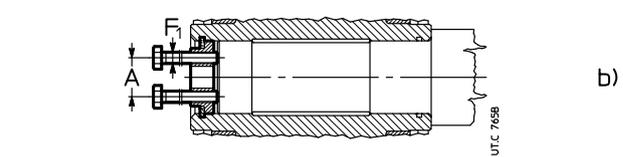
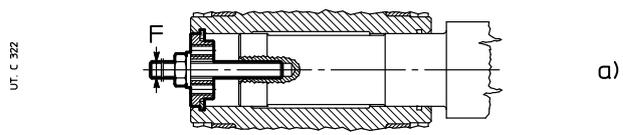

Axial fastening

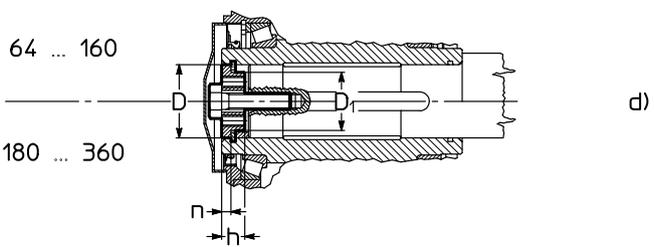
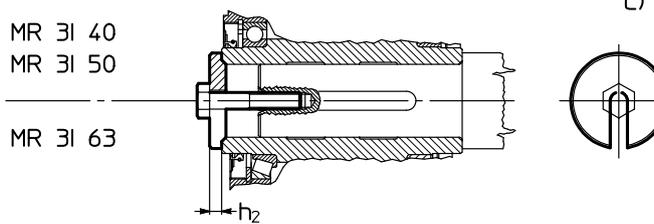
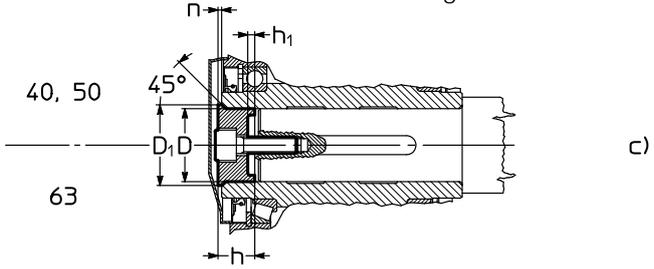

Fitting with key and locking rings e), with key and locking bushing f).

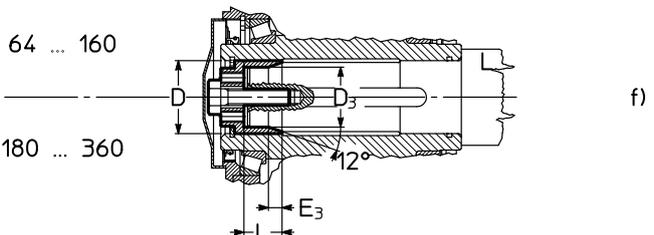
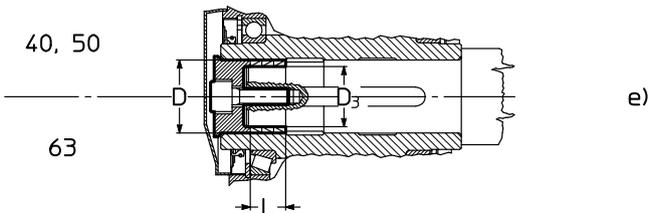

18. Installation and maintenance

Gear reducer size	A	D ∅	D ₁ ∅	D ₃ ∅	E r ₃	F	F ₁	h	h ₁	h ₂	L	n	Axial fastening bolt	
													UNI 5737-88	M _s ¹⁾ N m
40	–	19	22,5	15 ⁴⁾	–	M8	–	14,8	2,8	4	12,6 ⁴⁾	1,1	M8×25 ²⁾	29
50	–	24	27,5	19 ⁴⁾	–	M8	–	14,8	2,8	4	12,6 ⁴⁾	1,2	M8×25 ²⁾	35
63	–	30	34	25 ⁴⁾	–	M10	–	18,5	3,7	5	18,9 ⁴⁾	1,4	M10×30 ²⁾	43
64	18	32	23	27	9	M10	M6 ⁵⁾	10	–	–	19	6	M10×35	43
80	18	38	27	32	11	M10	M6 ⁵⁾	12	–	–	23	6	M10×35 ³⁾	51
81	18	40	28	34	11	M10	M6	12	–	–	23	6	M10×35 ³⁾	53
100	23	48	35	41	13	M12	M8	14	–	–	28	7	M12×45 ³⁾	92
125	30	60	45	52	15	M14	M12	16	–	–	35	7	M14×45 ³⁾	170
140	36	70	54	62	15	M16	M12	19	–	–	40	8	M16×50	210
160	45	80	63	70	20	M20	M12	19	–	–	45	8	M20×60	340
180	49	90	72	80	20	M20	M16	23	–	–	49	9	M20×60 ³⁾	430
200	56	100	81	88	24	M24	M16	23	–	–	52	10	M24×70	660
225	64	110	89	98	24	M24	M16	24	–	–	60	10	M24×70 ³⁾	830
250	72	125	102,5	110	30	M30	M20	28	–	–	67	11	M30×90	1 350
280	87	140	117	125	30	M30	M20	30	–	–	76	12	M30×90 ³⁾	1 660
320, 321	97	160	133,5	140	41	M36	M24	33	–	–	86	13	M36×110	2 570
360	117	180	153	160	41	M36	M24	36	–	–	95	14	M36×110 ³⁾	3 150

1) Tightening torque for locking rings or bushing.

2) UNI 5931-84. For MR 3I: M 8 × 35 and M 10 × 40 UNI 5737-88.

3) For locking bushing: M 10 × 35, M 12 × 45, M 14 × 45, class 10.9; M 20 × 65, M 24 × 80 and M 30 × 100 UNI 5737-88 class 10.9; M 36 × 120 UNI 5931-84 class 10.9.

4) Locking bushing is not possible for MR 3I.

5) It cannot be used for the disassembly of MR 3I.

Lubrication

Gear pairs are oil-bath lubricated with the exception of the first reduction stage in helical gear reducers train of gears **3I** and the first two reduction stages of gearmotors **4I** sizes ≤ 125 in V5 mounting position, which are lubricated «for life» with grease (SHELL Gadus S5). Bearings are either oil-bathed or splashed with the exception of the top bearings which are lubricated with a pump (see ch. 17(19)) or lubricated «for life» with grease (with or without NILOS ring according to speed).

Sizes 40 ... 81

The gear reducers are supplied **filled with synthetic oil** (KLÜBER Klübersynth GH 6-220, MOBIL Glygoyle 220, SHELL Omala S4 WE 220), providing lubrication – assuming pollution-free surroundings – «for life». Ambient temperature 0 ÷ 40 °C with peaks up to -20 °C and +50 °C.

Important: verify mounting position keeping in mind that if gear reducer is installed in a mounting position differing from the one stated on name plate, it could need the addition – through the proper hole – of the difference between the two lubricant quantities as shown in ch. 8, 10, 12 and 14.

Sizes 100 ... 360

The gear reducers are supplied **without oil**; before putting into service, fill to the specified level¹⁾, with **mineral oil** having the ISO viscosity grade given in the table. Under normal conditions the first speed range is for train of gears **I**, the second is for trains of gears **2I** and **CI**, the third is for trains of gears **3I**, **4I**, **C2I**, **ICI** and **C3I**, while the fourth is for **combined units**.

When it is required to increase oil change interval («long life»), the ambient temperature range and/or reduce oil temperature, use **synthetic oil** with polyalphaolefines basis having ISO viscosity grade as indicated in the table.

1) Lubricant quantities stated on ch. 8, 10, 12, 14 are approximate for provisioning. The exact oil quantity the gear reducer is to be filled with is definitely given by the level.

ISO viscosity grade

Mean kinematic viscosity [cSt] at 40 °C.

Speed n_2 min ⁻¹	Ambient temperature ¹⁾ [°C]		
	mineral oil		synthetic oil
	0 ÷ 20	10 ÷ 40	0 ÷ 40
> 224	150	150	150
224 ÷ 22,4	150	220	220
22,4 ÷ 5,6	220	320	320
< 5,6	320	460	460

1) Peaks of 10 °C (20 °C for synthetic oil) below and 10 °C above the ambient temperature range are acceptable.

Oil types

Manufacturer	PAO synthetic oil	mineral oil
	ISO VG 150 ... 460	ISO VG 150 ... 460
AGIP	Blasia SX	Blasia
ARAL	Degol PAS	Degol BG
BP	Energyn EPX	Energol GR XP
CASTROL	Alphasyn EP	Alpha SP
FUCHS	Renolin Unisys CLP	Renolin CLP
KLÜBER	Klübersynth GEM4	Klüberoil GEM1
MOBIL	Mobil SHC Gear	Mobilgear 600 XP
SHELL	Omala S4 GX	Omala S2 G
TEXACO	Pinnacle	Meropa
TOTAL	Carter SH	Carter EP

For continuous duty, the use of synthetic oil is recommended in the following cases:

- R ICI, MR C3I 100, 125 and MR ICI 100 ... 200 mounting position B6;
- R I 100 with $n_2 \geq 375$ min⁻¹;
- R CI 100 with $n_2 \geq 150$ min⁻¹;
- R 2I and MR 2I 125 with $i_N \leq 12,5$, mounting position B7, $n_1 \geq 950$ min⁻¹;
- MR ICI 200, motor size 225;

18. Installation and maintenance

- gear reducers and gearmotors with size and mounting position marked with Ψ (see ch. 8, 10, 12, 14) and bevel helical gear reducers with double extension high speed shaft.

An overall guide to oil-change interval²⁾ is given in the table, and assumes pollution-free surroundings. When heavy overloads are present, halve the values.

Oil temperature [°C]	Oil change interval [h]	
	mineral oil	synthetic oil
≤ 65	8 000	25 000
65 ÷ 80	4 000	18 000
80 ÷ 95	2 000	12 500
95 ÷ 110 ¹⁾	—	9 000

1) Values admissible for not continuous duty, only.

2) Values not valid for gear reducers according to ATEX directive; for values see ATEX instructions.

Apart from the running hours:

- replace the mineral oil at least each 3 years;
- replace or regenerate the synthetic oil at least each 5 - 8 years, according to gear reducer size, running and environmental conditions.

Never mix different makes of synthetic oil; if oil-change involves switching to a type different from that used previously, then give the gear reducer a thorough clean-out.

Combined gearmotor units

Lubrication remains independent, thus data relative to each single gear reducer hold good.

Seal rings

Duration depends on several factors such as dragging speed, temperature, ambient conditions, etc.; as a rough guide it can vary from 3150 to 25000 h.

Filler plug

For gear reducer sizes 100 ... 360, before unscrewing the filler plug with valve (symbol \ominus) wait until the unit has cooled and then open with caution.

Motor assembly and disassembly

Gearmotors with motor keyed onto hollow high speed shaft of gear reducer

Helical gearmotors MR 2I, MR 3I 140 ... 360

Bevel helical gearmotors MR CI, MR C2I

- be sure that the mating surfaces are machined under accuracy rating (IEC 60072-1);
- clean surfaces to be fitted thoroughly;
- check that the fit-tolerance (push-fit) between hole and shaft end is G7/j6 for $D \leq 28$ mm, F7/k6 for $D \geq 38$ mm;
- lubricate surfaces to be fitted against fretting corrosion;
- in the event of a lowered keyway, replace the motor key with the one supplied with the gear reducer; if necessary, check the key so that between its top and the bottom of the hole keyway there is a backlash of 0,1 - 0,2 mm; in case of output shaft keyway, lock the key by pins;

In presence of **hub clamp** (helical gearmotors 2I, 3I with motor sizes ≥ 200) proceed as follows, for the mounting:

- Turn the hub clamp until the fastening screw head is aligned with one of the access holes on gear reducers flange, after having removed the relevant closure plugs;
- do not modify the axial position of the hub clamp supplied from workshop, as this position is the excellent one in order to achieve the maximum tightening effect;
- push the motor up to shoulder;
- tighten the motor fastening screws or nuts to gear reducer motor flange;
- complete the tightening with dynamometric wrench up to the tightening torque stated in the table; during this operation pay attention not to modify the axial position of hub clamp;

Gear reducer size		Screw UNI 5931	Ms N m
2I	3I		
160 ... 225	200 ... 280	M12× 45 cl. 12.9	143
250... 360	320 ... 360	M12× 45 cl. 12.9 $\varnothing d \leq 75$ M14× 50 cl. 8.8 $\varnothing d = 80$	143 135

- screw again the closure plugs of access holes to gear reducer flange;

For the disassembly, proceed as follows:

- acting on motor shaft rear end, whenever possible, or disconnecting the gear reducer from machine and acting on gear reducer low speed shaft (with brake motor the brake must be released), align the wrench hole with the tightening screw of hub clamp;
- loosen the tightening screw and consequently the hub clamp (taking care not to modify the axial position of hub clamp);
- unscrew the motor fastening screws or nuts to gear reducer flange;
- disassemble the motor.

18. Installation and maintenance

Gearmotors with helical pinion keyed directly on motor shaft end

Helical gearmotors MR 3I 40 ... 125, MR 4I

Bevel helical gearmotors MR ICI, MR C3I

Coaxial gearmotors, coupled with helical and bevel helical gear reducers (combined units).

- be sure that the mating surfaces are machined under accuracy rating (IEC 60072-1);
- clean surfaces to be fitted thoroughly;
- check that the fit-tolerance (push-fit) between hole and shaft end is K6/j6 for $D \leq 28$ mm, J6/k6 for $D \geq 38$ mm;
- in the event of a lowered keyway, replace the motor keyway with the one supplied with the gear reducer; adjust the keyway length to the motor shaft, if need be; check that between the top and the bottom of the hole keyway there is a backlash of 0,1 - 0,2 mm; in the event of output shaft keyway, lock the key by pins.
- make sure that the motors have bearing location and overhang (distance S) as shown in the table;

Motor size	Min dynamic load capacity		Max dimension 'S' mm
	Front	Rear	
63	4 500	3 350	16
71	6 300	4 750	18
80	9 000	6 700	20
90	13 200	10 000	22,5
100	20 000	15 000	25
112	25 000	19 000	28
132	35 500	26 500	33,5
160	47 500	33 500	37,5
180	63 000	45 000	40
200	80 000	56 000	45
225	100 000	71 000	47,5

- assemble on motor shaft, as follows:
- the **spacer** pre-heated at **65 °C** sealing the motor shaft part with **locking adhesive type LOXEAL 58-14** and ensuring that between keyway and motor shaft shoulder there is a ground helical section of at least 1,5 mm; pay attention **not to damage the external surface** of spacer;
- the **key** in the keyway, taking care that a brief segment of at least 0,9 times the pinion width;
- the pinion pre-heated at **80 ÷ 100 °C**;
- the **axial fastening system** where foreseen (head self-locking screw with base, spacer, or hub clamp with one or more dowels, fig. a); for the cases foreseen **without axial fastening** (fig. b), seal with **locking adhesive type LOXEAL 58-14** also the motor shaft section below the **pinion**;
- in the event of axial fastening system with hub clamp and dowels, be sure that these ones do not overhang from spacer external surface: screw the dowel and matrix the motor shaft with a tip;
- grease the pinion teeth, the sealing ring rotary seat and the seal ring (with KLÜBER Petamo GHY 133N), and assemble carefully, **paying attention not to damage the seal ring lip due to accidental shock with the pinion toothing**.

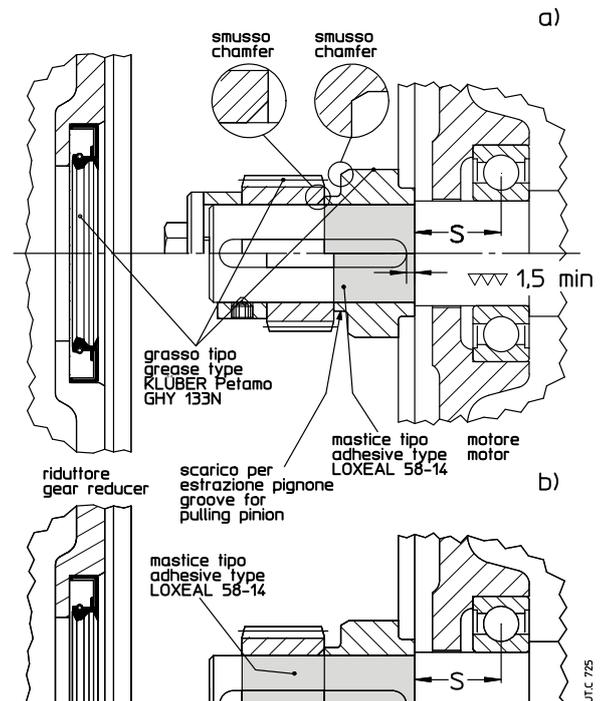

18. Installation and maintenance

Shaft mounting arrangements

The strength and shape of the housing offer advantageous possibilities for shaft mounting (for several reaction arrangements which can be supplied, see ch. 17 «Shaft mounting arrangements»), even - for instance - gearmotor with belt drive, with hydraulic coupling, low speed shaft support, etc.

A few shaft mounting arrangements are shown here with the relative details as to selection, and installation.

IMPORTANT: When shaft mounted, the gearmotor must be supported both axially and radially (even for mounting positions B3 ... B8) by the shaft end of driven machine, as well as anchored against rotation only, by means of a reaction having **freedom of axial movement** and sufficient clearance in its couplings to permit minor oscillations - always in evidence - without provoking dangerous overloads on the gearmotor. Lubricate with proper products the hinges and the parts subject to sliding; when tightening the screws it is recommended to apply locking adhesives type LOCTITE 601.

In case of shaft-mounting arrangement with elastic constraint, for the sizes 140 ... 360 C2I, 2I, 3I in B3 or B8 mounting position, ensure that the housing oscillation, during the running, not overtake - towards the top - the horizontal position.

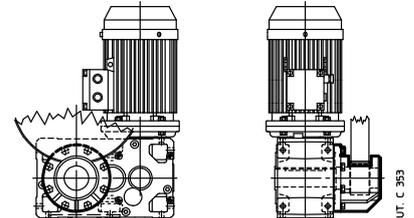
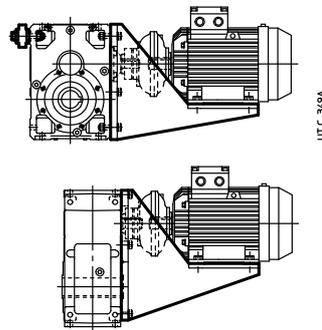
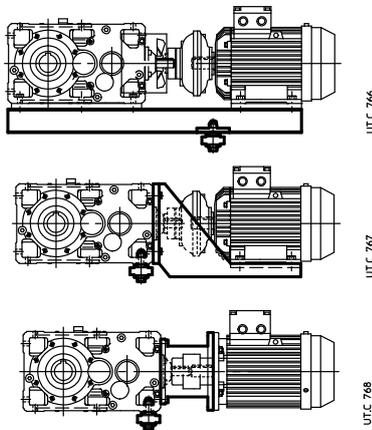
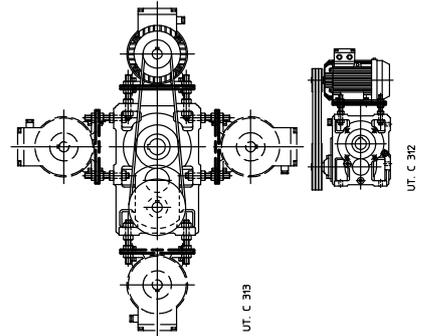

Semi-flexible and economic reaction arrangement for 2I, 3I, 4I sizes ≤ 125 (ch. 17) using **reaction recess and disc springs**.

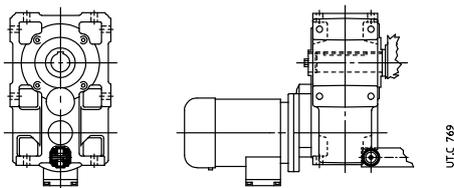

Semi-flexible and economic reaction arrangement for sizes ≤ 125 (ch. 17), with **bolt using disc springs**, suitable for low torque values.

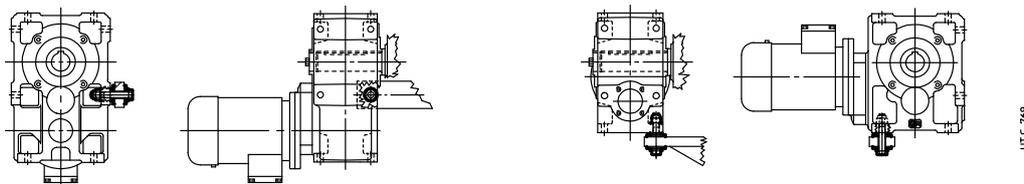

Semi-flexible and economic **reaction arrangement** for sizes ≥ 140 (≥ 125 for CI; ch. 17), using **disc springs**. Safety devices may be installed to prevent accidental overloads.

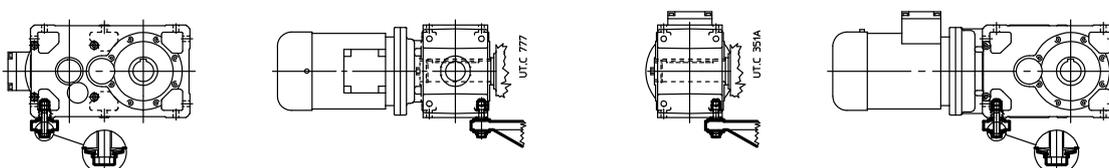

18. Installation and maintenance

Semi-flexible reaction arrangement (ch. 17), **using disc springs and bracket**.

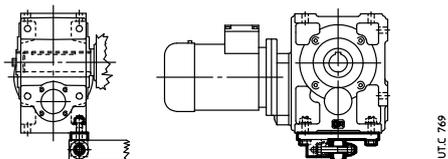

Rigid torque arm reaction arrangement for variable distance anchorage (ch. 17).

If the direction of rotation is opposite to that given in the fig. rotate the torque arm by 180°.

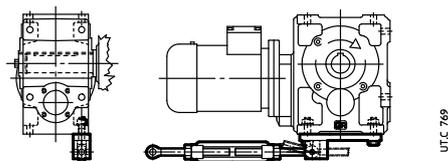

Reaction arrangement see above (ch. 17), but **flexible**; safety devices may be installed to prevent accidental overloads

The flexible torque arm may be turned through 180° regardless of direction of rotation.

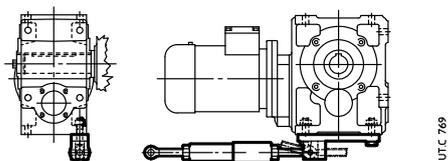

Flexible reaction arrangement using **rubber buffers** (drawings are approximate, but the buffers will be positioned abutting with gear reducer housing). It is possible to install safety devices against accidental overloads.



18. Installation and maintenance

For the majority of normal cases, where weight force G is parallel or orthogonal to reaction R_R as illustrated in the drawings, reactions are calculated thus (verify the worst condition) valid for long model too:

Helical gear units

A1

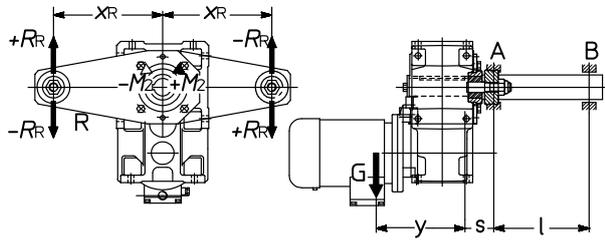

B

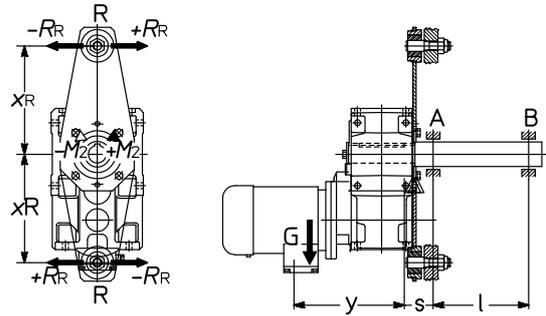

A2

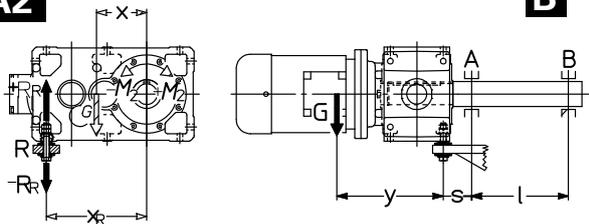

B

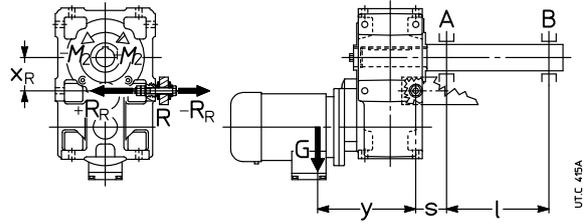

B

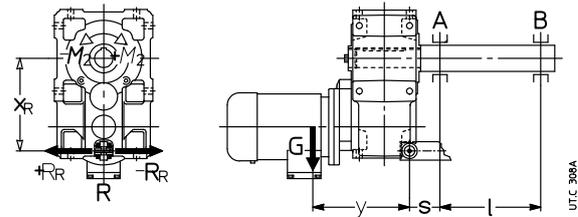

Bevel helical gear units

A1

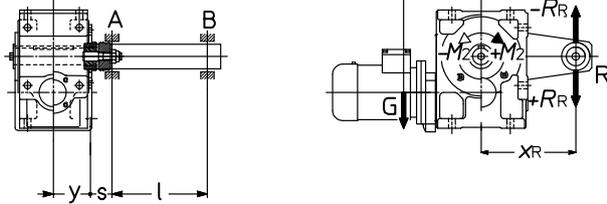

B

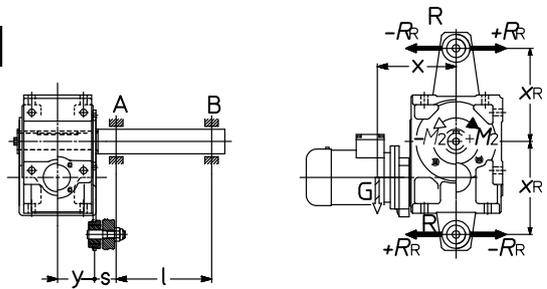

A1

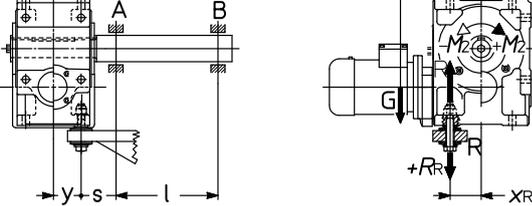

B

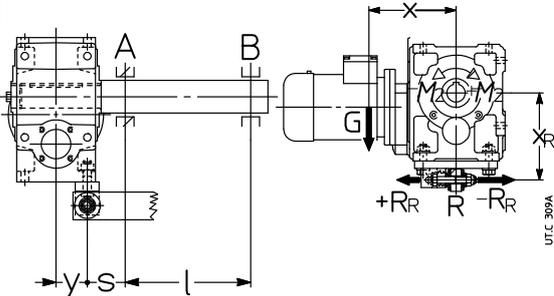

A2

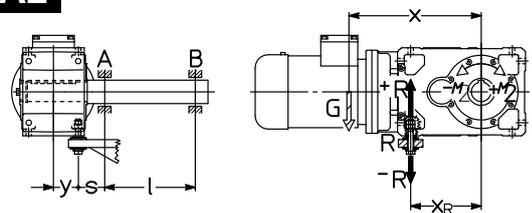

UTC 352A

18. Installation and maintenance

- G [N]: weight force almost equal numerically to gearmotor mass (ch. 12 and 14) · 10;
- M_2 [N m]: output torque expressed by + or – according to the direction of rotation in the drawing;
- x [m]: for helical gearmotors dimension $x = 0$ (scheme A1 and B) or $x = 0,67 \cdot a$ (scheme A2) (ch. 12); for bevel helical gearmotors dimension $x = G + 0,2 \cdot Y$ (schemes A1 and B) or $x = a + G + 0,2 \cdot Y$ (scheme A2) (ch. 14);
- y [m]: for helical gearmotors dimension $y = 0,5 \cdot B + G + 0,2 \cdot Y$ (ch. 12); for bevel helical gearmotors dimension $y = 0,5 \cdot B$ (ch. 14);
- x_R [m]: see ch. 12, 14, 17;
- l, s [m]: dimension s must be as short as possible.

1) reaction R_R produced by support R :

$$R_R = (1 / x_R) \cdot [G \cdot x + (\pm M_2)]$$

2) bending moment M_{fA} through the cross-section of bearing A:

$$\mathbf{A1 A2} \quad M_{fA} = [G \cdot (y + s)] - [(\pm R_R) \cdot s] \quad [\text{N m}]$$

$$\mathbf{B} \quad M_{fA} = \sqrt{[G \cdot (y + s)]^2 + [R_R \cdot s]^2} \quad [\text{N m}]$$

3) radial reaction R_A produced by bearing A:

$$\mathbf{A1 A2} \quad R_A = \frac{1}{l} \{ [G \cdot (y + s + l)] - [(\pm R_R) \cdot (s + l)] \} \quad [\text{N}]$$

$$\mathbf{B} \quad R_A = \frac{1}{l} \sqrt{[G \cdot (y + s + l)]^2 + [R_R \cdot (s + l)]^2} \quad [\text{N}]$$

4) radial reaction R_B produced by bearing B:

$$R_B = \frac{M_{fA}}{l}$$

18. Installation and maintenance

Fastening bolt dimensions for gear reducer feet

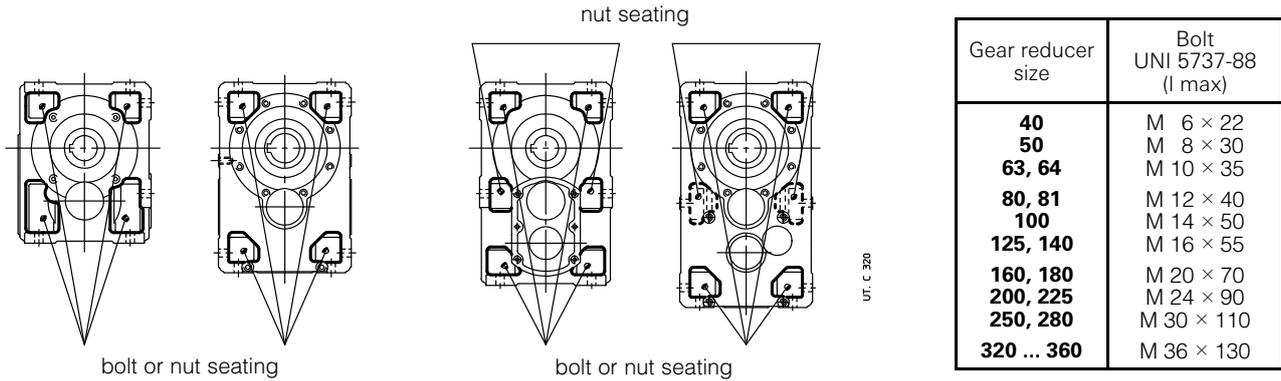

Tightening torque

Unless otherwise stated, usually it is sufficient to use bolts in class 8.8.

- Before tightening the bolt be sure that the eventual centering of flanges are inserted properly
- The bolts are to be diagonally tightened with the maximum tightening torque.

Before tightening, carefully degrease the bolts; for strong vibrations, heavy duties, frequent motion reversals, apply a thread-braking seal Loxeal 23-18 or equivalent.

Table of tightening torque for axial fastening bolts (locking rings or bushing) and shrink disc¹⁾

Gear reducer size	40	50	63	64	80	81	100	125	140	160	180	200	225	250	280	320, 321	360
Axial fastening bolts UNI 5737-88 cl. 8.8	M8 ²⁾	M8 ²⁾	M10 ²⁾	M10	M10 ³⁾	M10 ³⁾	M12 ³⁾	M14 ³⁾	M16	M20	M20 ³⁾	M24	M24 ³⁾	M30	M30 ³⁾	M36	M36 ⁴⁾
<i>M_s</i> [N m] for rings or bushing	29	35	43	43	51	53	92	170	210	340	430	660	830	1350	1660	2570	3150
Shrink disc bolts UNI 5737-88 class 10.9	M5	M5	M6	M6	M6	M6	M8	M8	M8	M10	M10	M12	M12	M16	M16	M16	M16
<i>M_s</i> [N m] for shrink disc	4	4	12	12	12	12	30	30	30	60	60	100	100	250	250	250	250

1) The bolts of shrink disc must be gradually and uniformly tightened, with continuous sequence (not diagonally!) and in several phases up to the reaching of maximum tightening torque stated on table.

2) UNI 5931-84 cl. 8.8 (excluding MR 3I).

3) UNI 5737-88 cl. 10.9.

4) UNI 5931-84 cl. 10.9.

Table of tightening torque for fastening bolts (feet, flange)

Screw	<i>M_s</i> [N m] UNI 5737-88, UNI 5931-84		
	cl. 8.8	cl. 10.9	cl. 12.9
M4	2,9	4	—
M5	6	8,5	10
M6	11	15	20
M8	25	35	40
M10	50	70	85
M12	85	120	145
M14	135	190	230
M16	205	290	350
M18	280	400	480
M20	400	560	680
M22	550	770	930
M24	710	1000	1200
M27	1000	1400	1700
M30	1380	1950	2350
M33	2000	2800	3400
M36	2500	3550	4200

Table of tightening torque for plugs

Gear reducer size	Thread dimension	<i>M_s</i> [N m]
40, 50	G 1/4"	7
63 ... 81	M16 × 1,5	14
100 ... 140	G 1/2"	14
160 ... 280	G 3/4"	14
320 ... 360	G 1"	25

Index of revisions

List of updatings - Edition **November 2014** available on www.rossi-group.com

- Page 32 - Updating of input speed n_1 sizes 250, 280 train of gears CI.
- Page 41 - Updating of text «Gear reducer input face».
- Page 42 - Updating of table «High and low speed shaft end» and table «Hollow low speed shaft».
- Page 48 - Updating of table «Bending moment and dimension HF».
- Page 114 - Added note *) for R 2I 140 ... 360.
- Page 117 - Updated position plugs for R 2I 140 ... 360.
- Page 118 - Added note *) for R 3I 140 ... 360. For sizes 250 and 280 modified dimension d_1 from 48 to 45.
- Page 121 - Updated position plugs for R 3I 140 ... 360.
- Page 125 - Updated position plugs for R 2I 100 ... 360 long model.
- Page 126 - For sizes 250 and 280 modified dimension d (for $i \geq 71$) from 45 to 48 and dimension d_1 from 48 to 45.
- Page 207 - Updated position plugs for R C2I 140 ... 360.
- Page 216 - Updating combined units $P_1 = 4$ kW with n_2 15,1 - 23,3 and 28,6.
- Page 229 - Added note *) for MR 2I 140 ... 360.
- Page 232 - Updated position plugs for MR 2I 140 ... 360.
- Page 235 - Added note *) for MR 3I 140 ... 360.
- Page 243 - Updated position plug for MR 4I 100, 125.
- Page 263 - Updated combined units $P_1 = 4$ kW with n_2 14,5 - 22,9.
- Page 279 - Shifted $i_n \geq 18$ from column e_1 to column d_1 for all sizes.
- Page 282 - Updated position plugs for MR CI 125 ... 280.
- Page 292 - Updated position plugs for MR C2I 140 ... 360.
- Page 298 - Updated UT.C 1284.
- Page 300 - Updated in the table the name of motor size $P_1 = 9,2$ kW.
- Pages 314 and 315 - Max F_{a2} value updated for size 200.
- Page 329 - Updated UT.C 321.
- Page 337 - Updated table C2I for MR 320 ... 360.

List of updatings - Edition **June 2015** (ch. 17) available on www.rossi-group.com

- Page 324 - Added note 1) in non standard design table (2).
- Page 326 - Added column $M2_{SD}$ in the table.
- Page 327 - Added subscript SD on $M2$ of the last column in the table.
- Page 331 - Added note 3) in non standard design table (10).
- Page 335 - Added note 1) in the table.
- Page 341 - Updated table. Added column Δm .
- Page 343 - Updated table non standard design (25).
- Page 353 - Updated tables and text about motor size choice.
- page 353 - Updated table 1 - corrective factors for ATEX.

List of updatings - Edition **June 2016** available on www.rossi-group.com

- Page 28 - Updated sentence about max ambient temperature stated in the table.
- Page 29 - Updated f_t for R I 140 ... 180 and modified $I_N \leq 8$ at $I_N \leq 11,2$ for MR CI in m.p. V5, V6.
- Page 32 - In the table cancelled speed n_1 for ICI 225 ... 360.
- Page 40 - Updated moments of inertia for train of gears 3I 360.
- Page 41 - Updated legenda of input flange including trains of gears R CI 125 ... 360 and R C2I 140 ... 360.
- Page 113 - Updated plug position for R I 125 ... 360.
- Page 117 - Updated plug position for R 2I 100, 125 and R 2I 140 ... 360.
- Page 121 - Updated plug position for R 3I 140 ... 360.
- Page 125 - Updated plug position for R 2I 140 ... 360 Long model.

Page 128 - Updated plug position for R 3I 140 ... 360 Long model.
Page 198 - Added note *) Machined surface for R CI 125 ... 360.
Page 201 - Updated plug position for R CI 125 ... 360.
Page 204 - Updated plug position for R ICI 100 ... 200.
Page 205 - Added note **) Machined surface for R C2I 140 ... 360.
Page 232 - Updated plug position for MR 2I 140 ... 360.
Page 238 - Updated plug position for MR 3I 140 ... 360.
Page 248 - Updated plug position for MR 2I 140 ... 225 Long model.
Page 254 - Updated plug position for MR 3I 140 ... 225 Long model.
Page 279 - Added note *) Machined surface for MR CI 125 ... 360.
Page 289 - Added note **) Machined surface for MR C2I 140 ... 360.
Page 324 - Added column Z_2 and updated UT.C 2067.
Page 325 - Added note 1) dimension E and E_2 in the table - Stepped hollow low speed shaft.
Page 326 - Added note 4) dimension E and E_2 in the table - Stepped hollow low speed shaft with shrink disc.
Page 328 - Added note 3) dimension E and E_2 .
Page 333 - Added UT.C 443A and updated note 1).
Page 328 - Added coil material list and updated UT.C 2066.
Page 340 - Updated pump table.
Page 341 - Added mounting positions V5 and V6 information for pump in the pictures.
Page 345 - Updated table about High speed shaft double seal (non-std. design (26)).
Page 348 - Updated text of non-std. design (30).
Page 349 - Updated text of non-std. design (31).
Page 353 - Updated text of non-std. design ATEX (37).
Page 360 - Updated chapter about Safety.
Page 361 - Added note 2) in the table.
Page 362 - Updated UT.C 765B.

Notes:

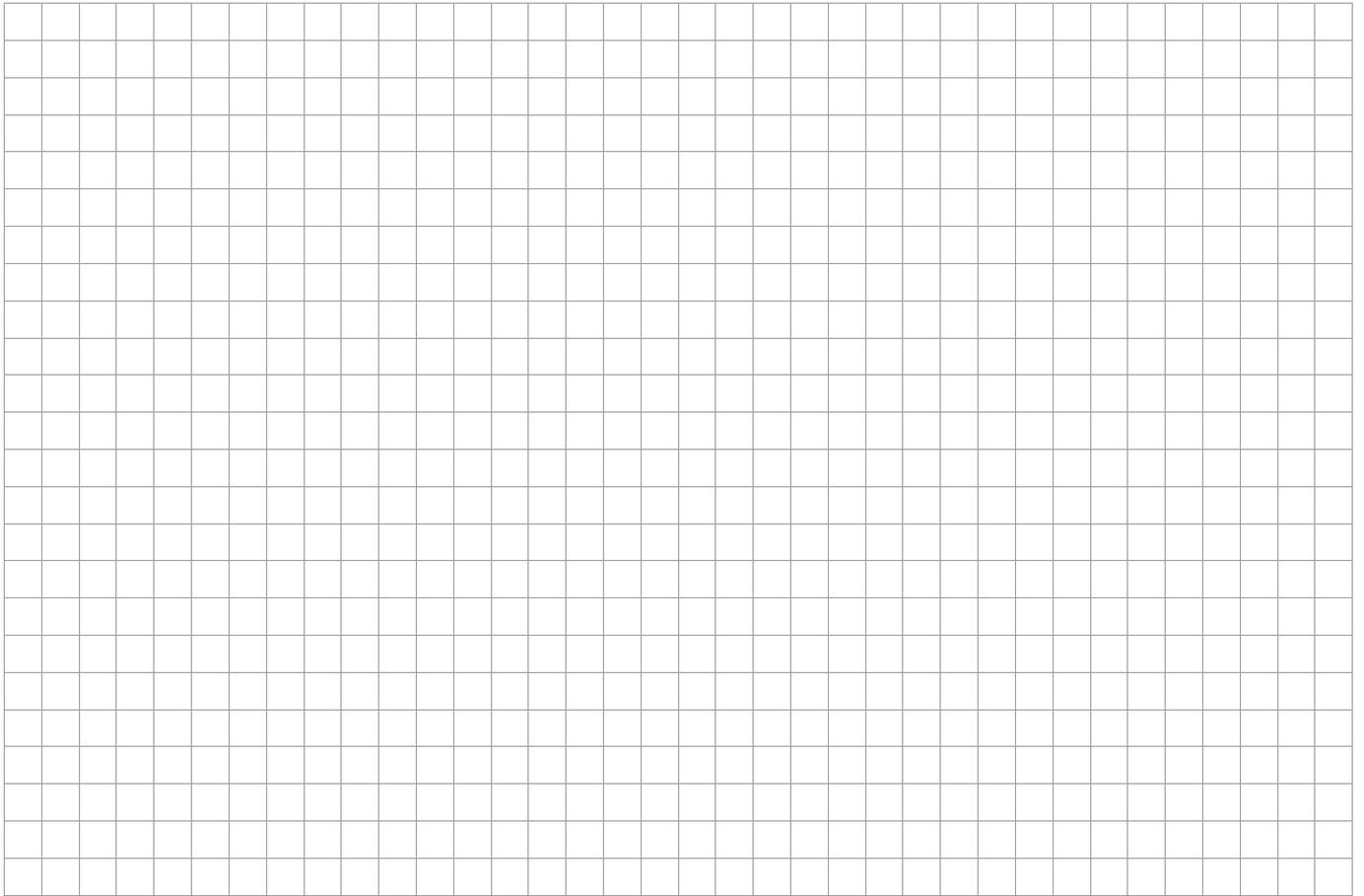

Technical formulae

Main formulae concerning mechanical drives, according to the Technical System and International Unit System (SI).

Size	With Technical System units	With SI units
starting or stopping time as a function of an acceleration or deceleration, of a starting or braking torque	$t = \frac{v}{a} \text{ [s]}$ $t = \frac{Gd^2 \cdot n}{375 \cdot M} \text{ [s]}$	$t = \frac{J \cdot \omega}{M} \text{ [s]}$
velocity in rotary motion	$v = \frac{\pi \cdot d \cdot n}{60} = \frac{d \cdot n}{19,1} \text{ [m/s]}$	$v = \omega \cdot r \text{ [m/s]}$
speed	$n = \frac{60 \cdot v}{\pi \cdot d} = \frac{19,1 \cdot v}{d} \text{ [min}^{-1}\text{]}$	$\omega = \frac{v}{r} \text{ [rad/s]}$
acceleration or deceleration as a function of starting or stopping time		$a = \frac{v}{t} \text{ [m/s}^2\text{]}$
angular acceleration or deceleration as a function of a starting or stopping time, of a starting or braking torque	$\alpha = \frac{n}{9,55 \cdot t} \text{ [rad/s}^2\text{]}$ $\alpha = \frac{39,2 \cdot M}{Gd^2} \text{ [rad/s}^2\text{]}$	$\alpha = \frac{\omega}{t} \text{ [rad/s}^2\text{]}$ $\alpha = \frac{M}{J} \text{ [rad/s}^2\text{]}$
starting or stopping distance as a function of a starting or stopping time, of a starting or braking velocity		$s = \frac{a \cdot t^2}{2} \text{ [m]}$ $s = \frac{v \cdot t}{2} \text{ [m]}$
starting or stopping angle as a function of an angular acceleration or deceleration, of a final or initial angular velocity	$\varphi = \frac{n \cdot t}{19,1} \text{ [rad]}$	$\varphi = \frac{\omega \cdot t}{2} \text{ [rad]}$
mass	$m = \frac{G}{g} \text{ [}\frac{\text{kgf s}^2}{\text{m}}\text{]}$	m is the unit of mass [kg]
weight (weight force)	G is the unit of weight (weight force) [kgf]	$G = m \cdot g \text{ [N]}$
force in vertical (lifting), horizontal, inclined motion of translation (μ = coefficient of friction; φ = angle of inclination)	$F = G \text{ [kgf]}$ $F = \mu \cdot G \text{ [kgf]}$ $F = G (\mu \cdot \cos \varphi + \text{sen } \varphi) \text{ [kgf]}$	$F = m \cdot g \text{ [N]}$ $F = \mu \cdot m \cdot g \text{ [N]}$ $F = m \cdot g (\mu \cdot \cos \varphi + \text{sen } \varphi) \text{ [N]}$
dynamic moment Gd^2, moment of inertia J due to a motion of translation (numerically $J = \frac{Gd^2}{4}$)	$Gd^2 = \frac{365 \cdot G \cdot v^2}{n^2} \text{ [kgf m}^2\text{]}$	$J = \frac{m \cdot v^2}{\omega^2} \text{ [kg m}^2\text{]}$
torque as a function of a force, of a dynamic moment or of a moment of inertia, of a power	$M = \frac{F \cdot d}{2} \text{ [kgf m]}$ $M = \frac{Gd^2 \cdot n}{375 \cdot t} \text{ [kgf m]}$ $M = \frac{716 \cdot P}{n} \text{ [kgf m]}$	$M = F \cdot r \text{ [N m]}$ $M = \frac{J \cdot \omega}{t} \text{ [N m]}$ $M = \frac{P}{\omega} \text{ [N m]}$
work, energy in motion of translation, in rotary motion	$W = \frac{G \cdot v^2}{19,6} \text{ [kgf m]}$ $W = \frac{Gd^2 \cdot n^2}{7160} \text{ [kgf m]}$	$W = \frac{m \cdot v^2}{2} \text{ [J]}$ $W = \frac{J \cdot \omega^2}{2} \text{ [J]}$
power in motion of translation, in rotary motion	$P = \frac{F \cdot v}{75} \text{ [CV]}$ $P = \frac{M \cdot n}{716} \text{ [CV]}$	$P = F \cdot v \text{ [W]}$ $P = M \cdot \omega \text{ [W]}$
power available at the shaft of a single-phase motor ($\cos \varphi$ = power factor)	$P = \frac{U \cdot I \cdot \eta \cdot \cos \varphi}{736} \text{ [CV]}$	$P = U \cdot I \cdot \eta \cdot \cos \varphi \text{ [W]}$
power available at the shaft of a three-phase motor	$P = \frac{U \cdot I \cdot \eta \cdot \cos \varphi}{425} \text{ [CV]}$	$P = 1,73 \cdot U \cdot I \cdot \eta \cdot \cos \varphi \text{ [W]}$

Note. Acceleration or deceleration are understood constant; motion of translation and rotary motion are understood rectilinear and circular respectively.

Every decision we make at Rossi impacts the world we live in. But new technologies and renewed commitment to sustainable practices have provided us with the opportunity to make environmentally friendly printing decisions. Our catalogs are printed on Forest Stewardship Council® (FSC®) certified paper ⁽¹⁾. This is our tangible commitment in terms of environment sustainability.

⁽¹⁾ The certification means that finished wood-based products in the marketplace have been handled by companies that have also been certified and that the paper has been handled in an environmentally-friendly manner.

Australia

Rossi Gearmotors Australia Pty. Ltd.
e-mail: info.australia@rossi-group.com
www.rossi-group.com/australia

Benelux

Rossi BeNeLux B.V.
e-mail: info.benelux@rossi-group.com
www.rossi-group.com/benelux

Brazil

Rossi do Brasil LTDA
e-mail: info.brazil@rossi-group.com
www.rossi-group.com/brazil

China

Rossi Gearmotors China P.T.I.
e-mail: info.china@rossi-group.com
www.rossi-group.com/china

France

Rossi Motorréducteurs SARL
e-mail: info.france@rossi-group.com
www.rossi-group.com/france

Germany

Rossi GmbH
e-mail: info.germany@rossi-group.com
www.rossi-group.com/germany

India

Rossi Gearmotors Pvt. Ltd.
e-mail: info.india@rossi-group.com
www.rossi-group.com/india

Malaysia

Rossi Gearmotors South East Asia Sdn Bhd
e-mail: info.malaysia@rossi-group.com
www.rossi-group.com/malaysia

Poland

Rossi Polska Sp.z o.o.
e-mail: info.poland@rossi-group.com
www.rossi-group.com/poland

Spain, Portugal

Rossi Motorreductores S.L.
e-mail: info.spain@rossi-group.com
www.rossi-group.com/spain

South Africa

Rossi Southern Africa
e-mail: info.southafrica@rossi-group.com
www.rossi-group.com/southafrica

Taiwan

Rossi Gearmotors Co. Ltd.
e-mail: info.taiwan@rossi-group.com
www.rossi-group.com/taiwan

Turkey

Rossi Turkey & Middle East
e-mail: info.turkey@rossi-group.com
www.rossi-group.com/turkey

United Kingdom

Rossi Gearmotors Ltd.
e-mail: info.uk@rossi-group.com
www.rossi-group.com/unitedkingdom

United States, Canada, Mexico

Rossi North America
e-mail: info.northamerica@rossi-group.com
www.rossi-group.com/northamerica

Global Service

Rossi S.p.A.
e-mail: aftersales@rossi-group.com

Product liability, application considerations

The Customer is responsible for the correct selection and application of product in view of its industrial and/or commercial needs, unless the use has been recommended by technical qualified personnel of Rossi, who were duly informed about customer's application purposes. In this case all the necessary data required for the selection shall be communicated exactly and in writing by the Customer, stated in the order and confirmed by Rossi. The Customer is always responsible for the safety of product applications. Every care has been taken in the drawing up of the catalog to ensure the accuracy of the information contained in this publication, however Rossi can accept no responsibility for any errors, omissions or outdated data. Due to the constant evolution of the state of the art, Rossi reserves the right to make any modification whenever to this publication contents. The responsibility for the product selection is of the customer, excluding different agreements duly legalized in writing and undersigned by the Parties.

Rossi S.p.A.

Via Emilia Ovest 915/A
41123 Modena - Italy
Phone +39 059 33 02 88
fax +39 059 82 77 74
e-mail: info@rossi-group.com
www.rossi-group.com

Registered trademarks
Copyright Rossi S.p.A.
Subject to alterations
Printed in Italy
Edition June 2016

